

ZT-USB Series

User Manual

Warranty

All products manufactured by ICP DAS are under warranty regarding defective materials for a period of one year, beginning from the date of delivery to the original purchaser.

Warning

ICP DAS assumes no liability for any damage resulting from the use of this product. ICP DAS reserves the right to change this manual at any time without notice. The information furnished by ICP DAS is believed to be accurate and reliable. However, no responsibility is assumed by ICP DAS for its use, nor for any infringements of patents or other rights of third parties resulting from its use.

Copyright

Copyright © 2013 by ICP DAS. All rights are reserved.

Trademarks

Names are used for identification purpose only and may be registered trademarks of their respective companies.

Technology Support

If you have any problems, please feel free to contact us via email at service@icpdas.com

Table of Contents

1	Introduction to ZigBee.....	3
2	Introduction to the ZT-USB Series	4
3	Hardware Information	5
3.1	ZT-USB Series Front View.....	5
3.2	Dimensions (Units: mm).....	6
3.3	Block Diagram.....	7
4	Installing Driver and Utility	8
4.1	Installing the ZT-USB Serial Port Driver.....	8
4.2	Inserting the ZT-USB and installing Driver.....	11
4.3	Installing the Configuration Tool.....	15
5	Setting up the ZT-USB Series	17
5.1	Introduction of configurations.....	17
5.2	Configuring ZigBee Setting.....	22
5.3	Test Communications.....	25
5	Applications	26
6	Troubleshooting	27
6.1	Technical Support.....	27
6.2	LED Indicator Status.....	28

1 *Introduction to ZigBee*

ZigBee is a specification for a suite of high-level communication protocols using small, low-power digital radios based on the IEEE 802.15.4 standard for personal area networks. ZigBee devices are often used in mesh network form to transmit data over longer distances, passing data through intermediate devices to reach more distant ones. This allows ZigBee networks to be formed ad-hoc, with no centralized control or high-power transmitter/receiver able to reach all of the devices. Any ZigBee device can be tasked with running the network.

ZigBee is targeted at applications that require a low data rate, long battery life, and secure networking. ZigBee has a defined rate of 250 kbit/s, best suited for periodic or intermittent data or a single signal transmission from a sensor or input device. Applications include wireless light switches, electrical meters with in-home-displays, traffic management systems, and other consumer and industrial equipment that requires short-range wireless transfer of data at relatively low rates. The technology defined by the ZigBee specification is intended to be simpler and less expensive than other WPANs.

2 *Introduction to the ZT-USB Series*

The Basis of ZT-USB Series Product

The ZT-USB series modules are small-sized wireless ZigBee converters based on the IEEE802.15.4 standard that allow USB interface to be converted to a personal area ZigBee network. The typical transmission of ICP DAS ZT-USB series ZigBee products is 60 meters (LOS, line of sight), with a transmission frequency range of between 2.405 GHz and 2.48 GHz, separated into 5 MHz sectors, providing 16 channels and 16384 PAN IDs. ZT-USB series is not only a long distance wireless converter but also can act a ZigBee router to extend the transmission range and improve the quality of wireless signal.

ZT-USB series products are specification for a suite of high level communication protocols using small, low-power digital radios module, which are fitted the ZigBee 2007 (ZigBee Pro) of ZigBee Alliance. In the ZigBee network, it is only allowed one ZigBee Host and called "ZigBee Coordinator", ZT-USBC is used to initialize and manager the routing. In addition, One ZigBee network are able to manager 255 ZigBee router and responsible for receiving or bypassing data from parent or child node.

A Windows compatible GUI configuration utility is available, and the utility allows users to set different configurations based on the type of application, together with several of required ZigBee variables such as Pan ID. The friendly user interface is also helping user be familiar with ZT-USB and ZT series.

3

Hardware Information

3.1 ZT-USB Series Front View

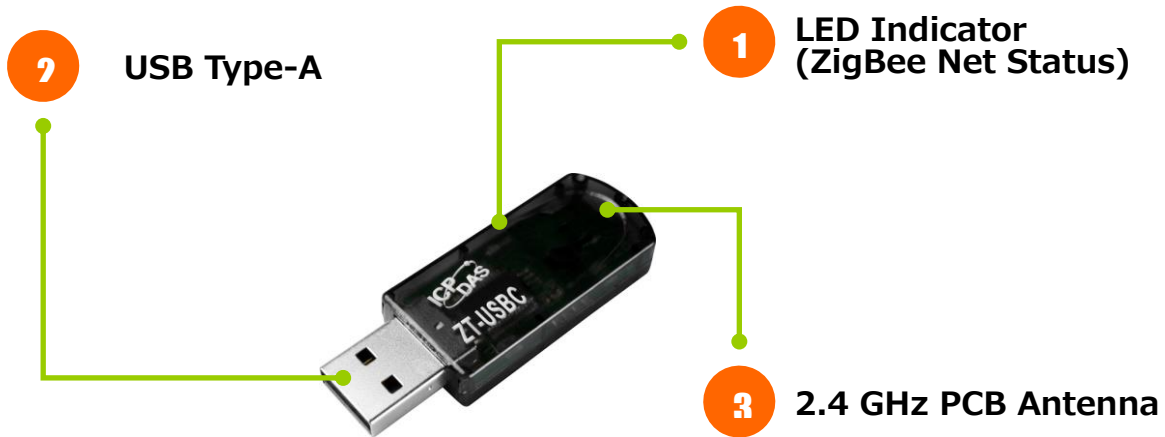

1. LED Indicator

LED Indicator	LED Color	Explanation
ZigBee Net	Red	The status of ZigBee network.

2. USB Type-A Plug

- The port is used to configure ZT-USB series, communicate with other ZT-2000 modules and be powered via the USB socket.

3. 2.4 GHz PCB Antenna

- There is PCB antenna inside ZT-USB series which is no additional antenna required.

3.2 Dimensions (Units: mm)



Top View

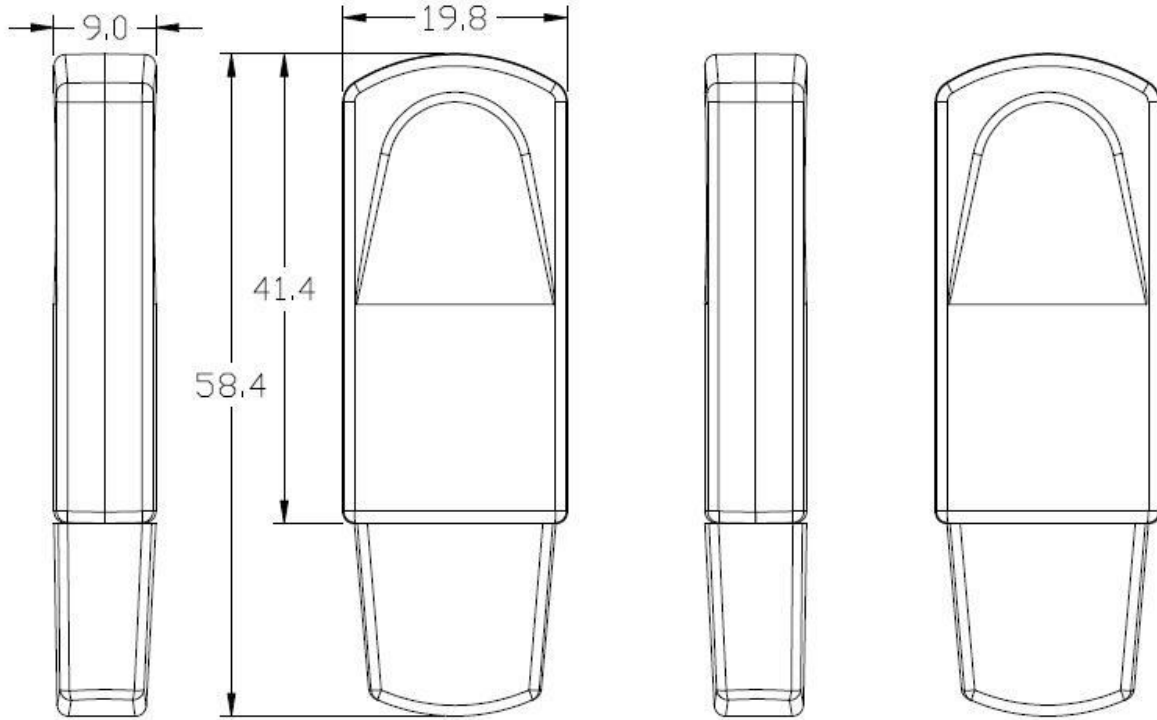

Left Side View

Front View

Right Side View

Rear View



Bottom View

Unit: mm

3.3 Block Diagram

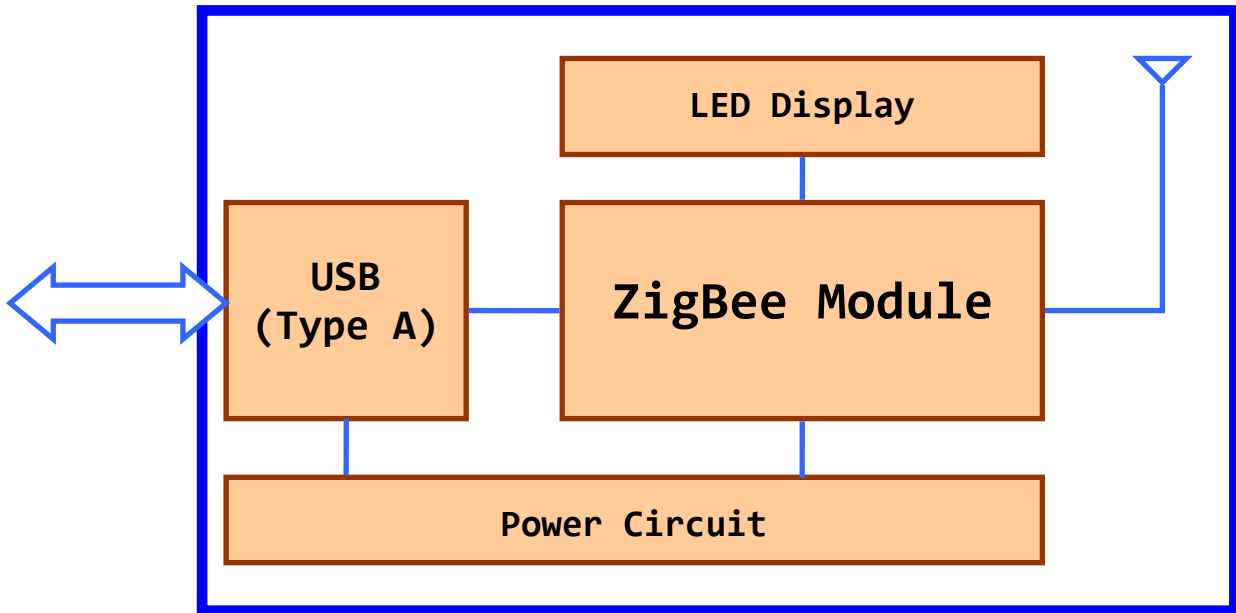

4 *Installing Driver and Utility*

4.1 Installing the ZT-USB Serial Port Driver

1. Search ZT-USBC and download the file from website (<https://www.icpdas.com>)

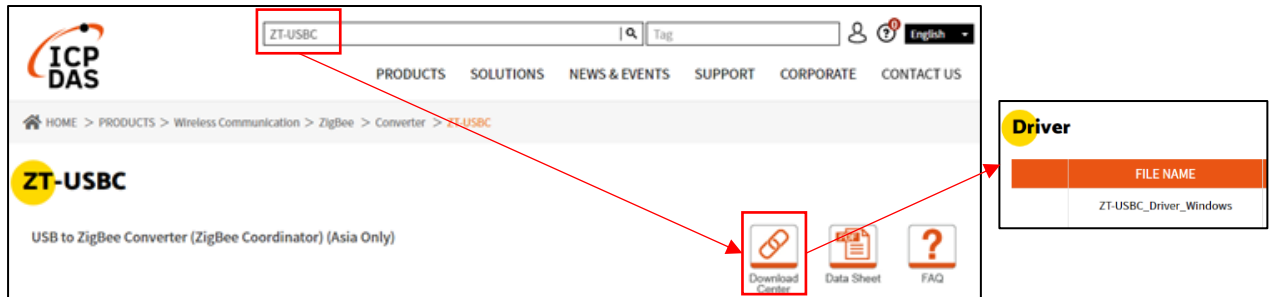

2. **Right click** the “ZT-USB_Series_Driver_Installer.exe” file and select the item that **Run as administrator** to install the driver for the ZT-USB series.

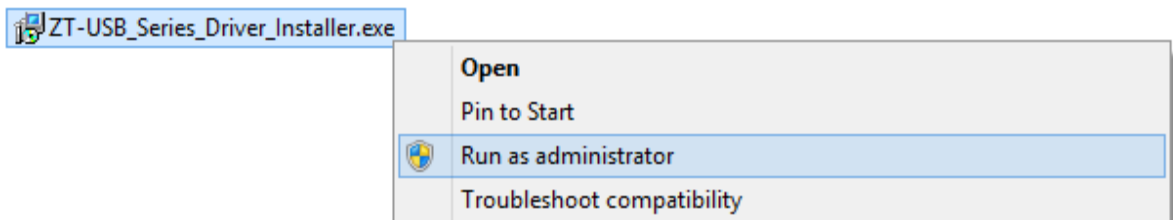

3. When the following screen is displayed, click the **Next >** button to continue.

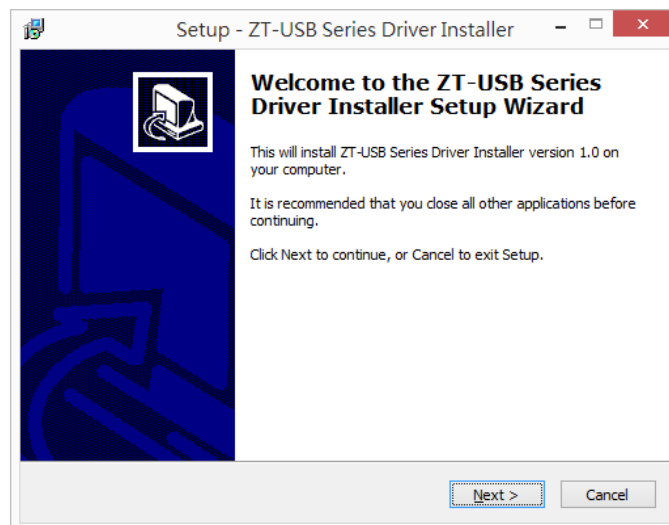

4. When the following screen is displayed, click the **Install** button to continue.

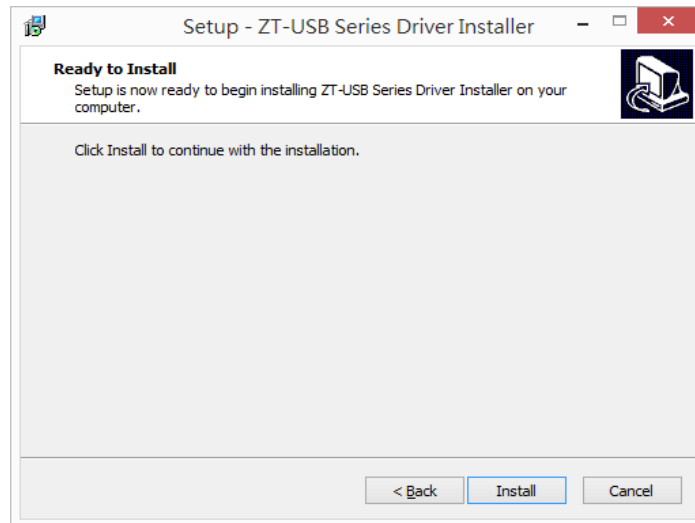

5. When the following screen is displayed, click the **Next >** button to continue.

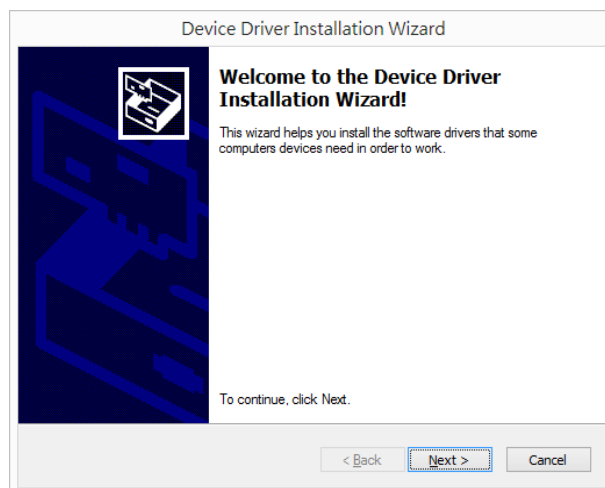

6. If the following screen is displayed, click the **Always trust software from "ICP DAS Co., LTD."** and press **Install** button to continue.

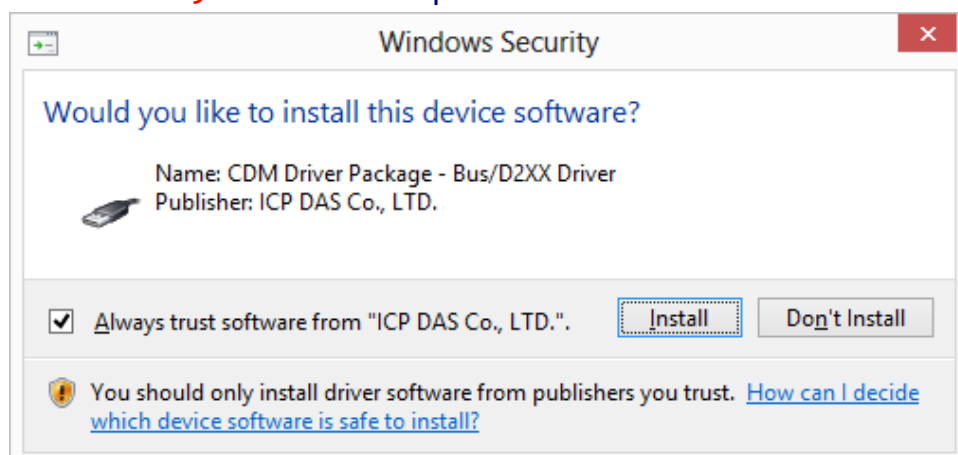

7. When the following screen is displayed, click the **Finish** button to continue.

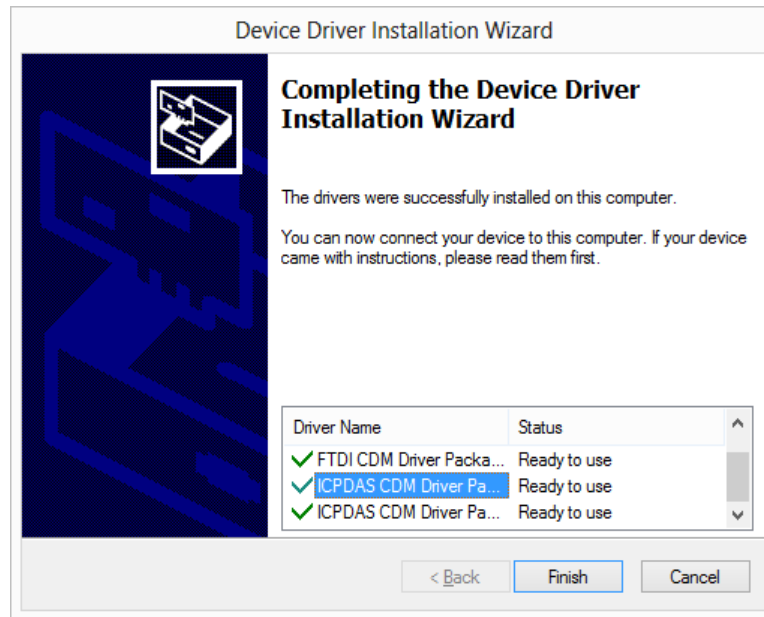

8. When the following screen is displayed, click the **Finish** button to completing the installation.

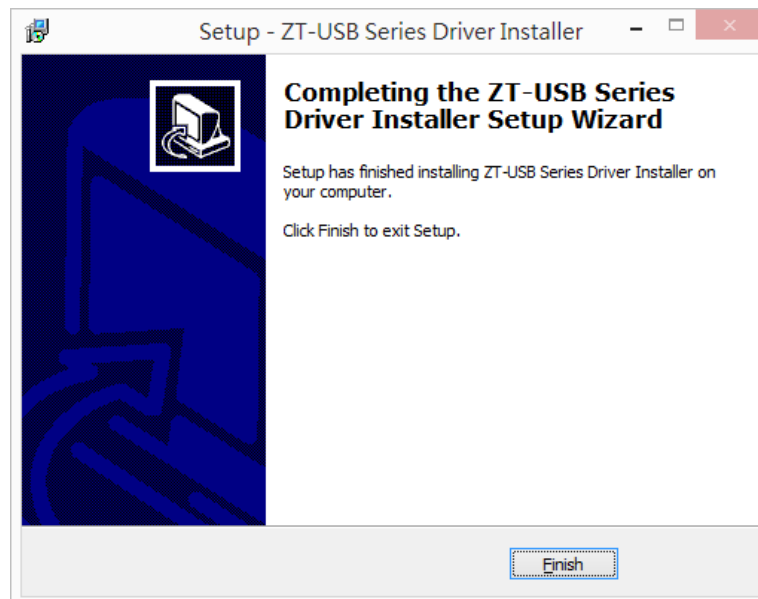

4.2 Inserting the ZT-USB and installing Driver

1. Insert the ZT-USB series to USB socket in your computer. If Windows detects the new device, it will install the driver automatically and successfully.

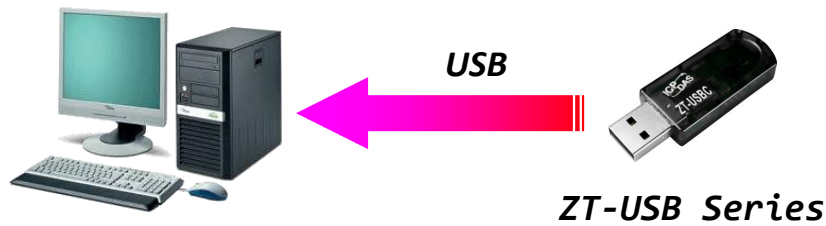

2. Right click on **My Computer** and select **Properties**.

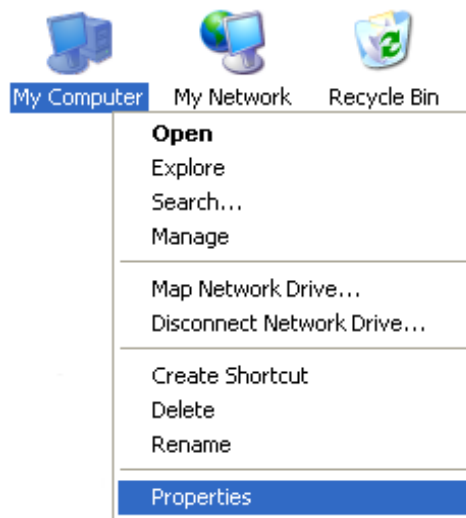

3. Select **Device Manager** from the **System Properties** dialog box.

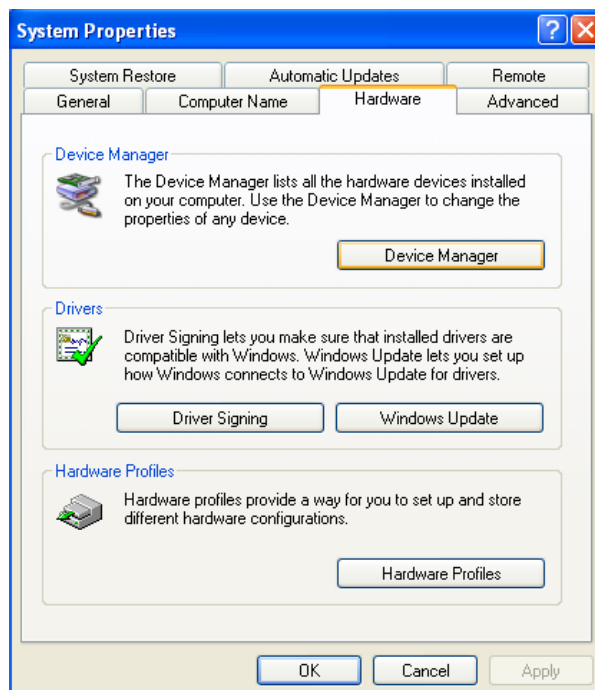

4. Confirm the **COM Number** of the ZT-USB Series is listed in the **Ports (COM & LPT)**.

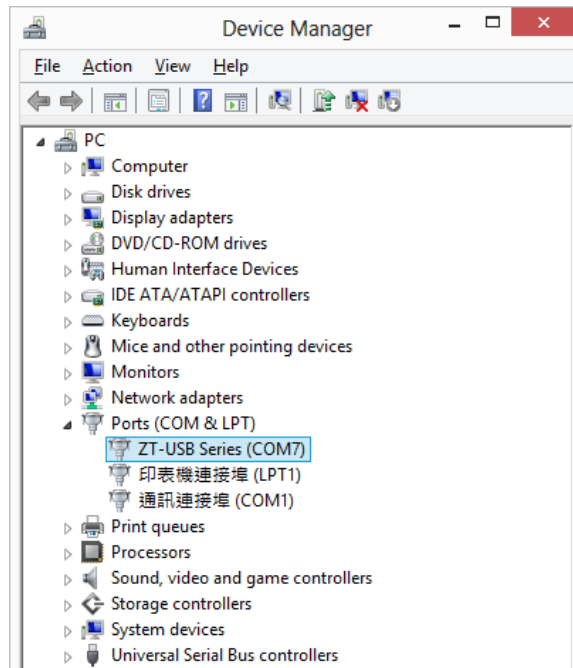

5. If Windows Ports (COM & LPT) is failed to allocate the COM Port Number of ZT-USB Series, you should find **USB Serial Port** item below **Other devices** and right Click the **“Update Driver Software...”** to update driver manually.

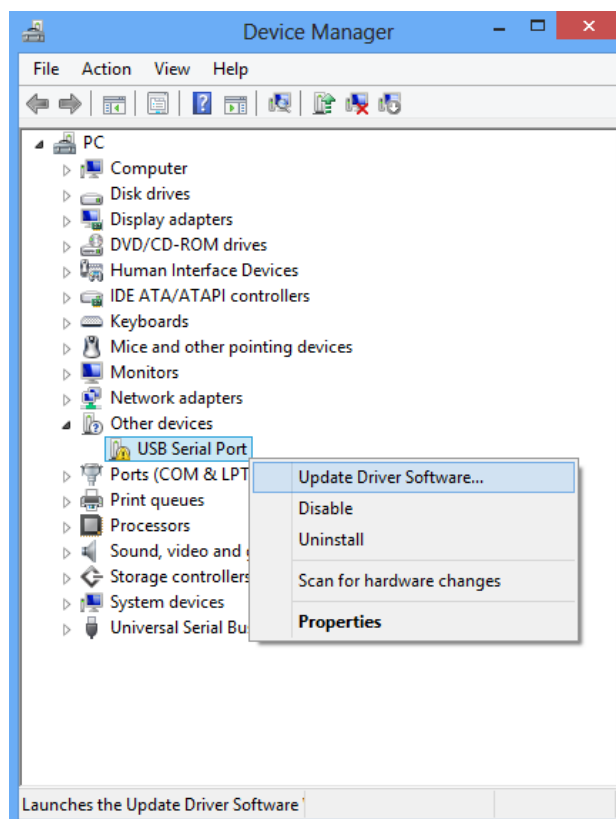

6. When the following screen is displayed, select the **“Browse my computer for driver software”** Option to continue.

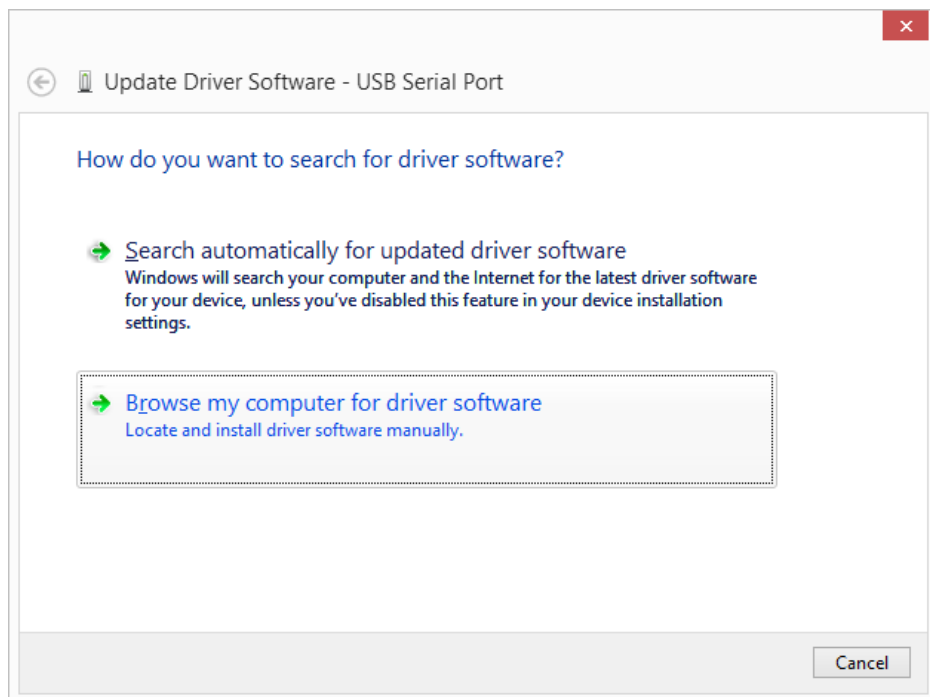

7. Browse to **C:\ICPDAS\ZT-USB\driver** to locate the installation file, and click **“Include subfolders”** and the **Next** button to begin the search.

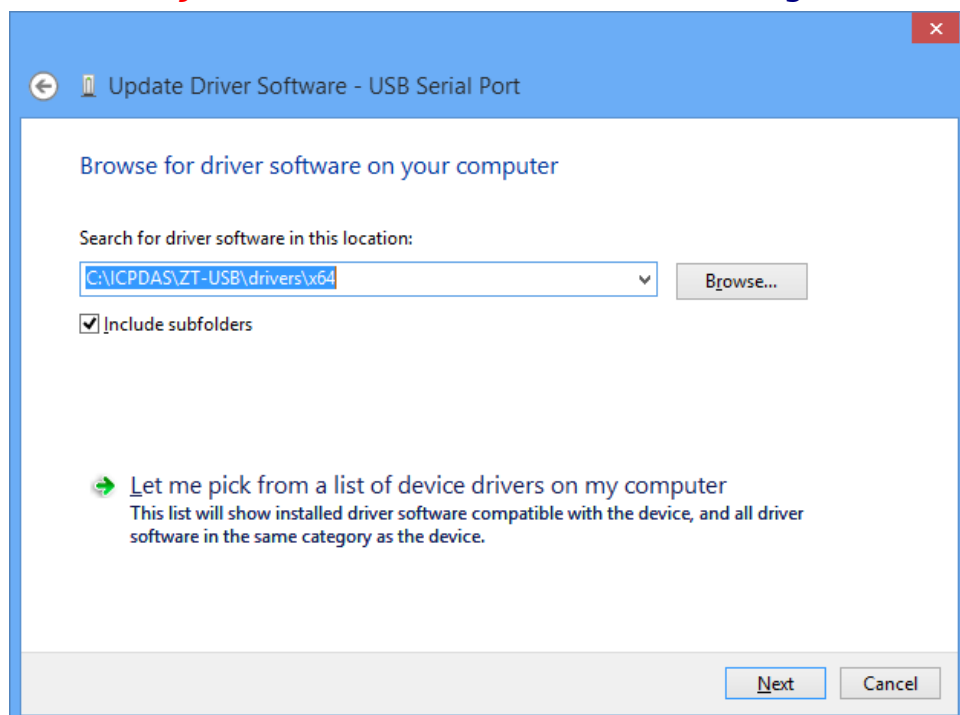

8. When the following screen is displayed, click the **Close** button to finalize the software installation.

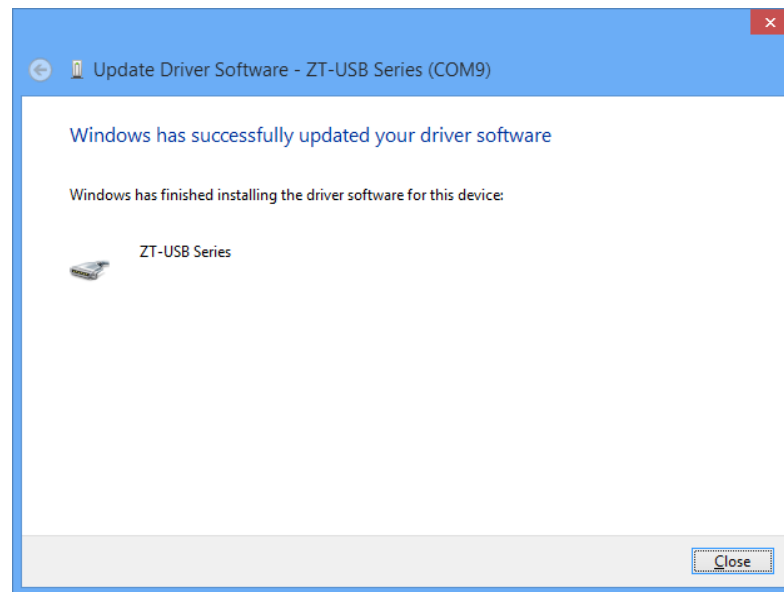

NOTICE: When the driver installation is complete, unplug ZT-USB Series and insert it in again.

9. Now you can find out the correct **COM Port Number** of ZT-USB series in the **Device Manager**.

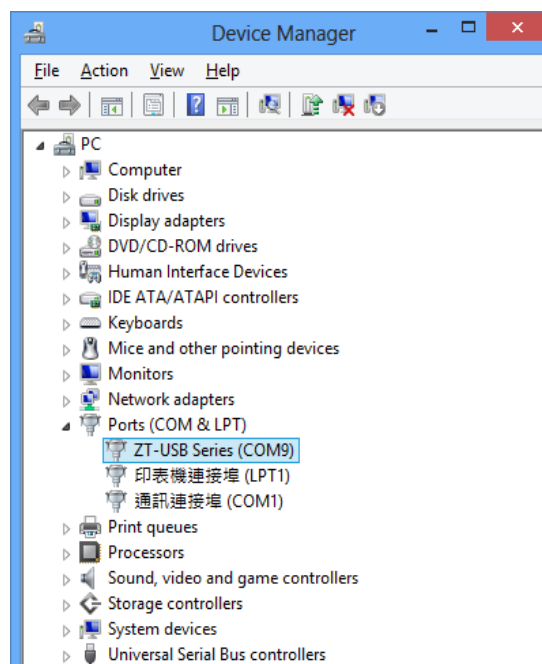

4.3 Installing the Configuration Tool

1. Search ZT-USBC and download the file from the website (<https://www.icpdas.com>)

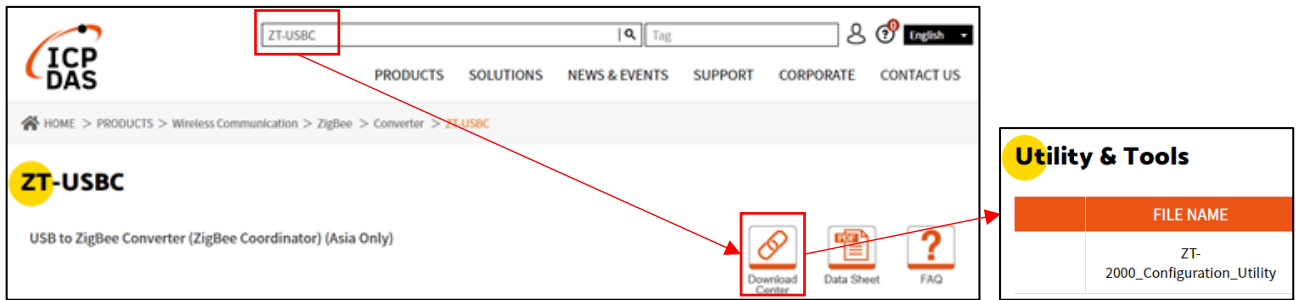

2. Double click the **ZT2000_Configuration_Utility_vxxx.exe** file to install the configuration tool for the ZT-USB series.



3. When the following screen is displayed, you can click the **Next >** button to install the software into the default directory or click the **Change...** button to install into an alternate location.



4. When the following screen is displayed, click the **Next >** button to continue.



5. When the following screen is displayed, click the **Finish** button to finalize the software installation.



5 *Setting up the ZT-USB Series*

5.1 Introduction of configurations

1. **“Pan ID”** is the group identity of a ZigBee network, and must be the same if they are in the same ZigBee network.
(Valid values range from 0x0000 to 0x3FFF)

2. **“Node ID”** is the identity of the ZigBee module.

The identity number must be unique if it is in the same ZigBee network as other ZigBee module. (Valid values range from 0x0001 to 0xFFFF7 for a ZigBee Router, but is fixed to 0x0000 for a ZigBee Coordinator)

3. **“RF Channel”** indicates the radio frequency channel, and must be set to the same channel if the module is in the same ZigBee network as other ZigBee modules.

Channel	0x00	0x01	0x0F
Frequency(MHz)	2405	2410	2480

※ In addition, the RF channels 0x04, 0x09, 0x0E and 0x0F are recommended because they are not covered with the frequency of Wi-Fi.

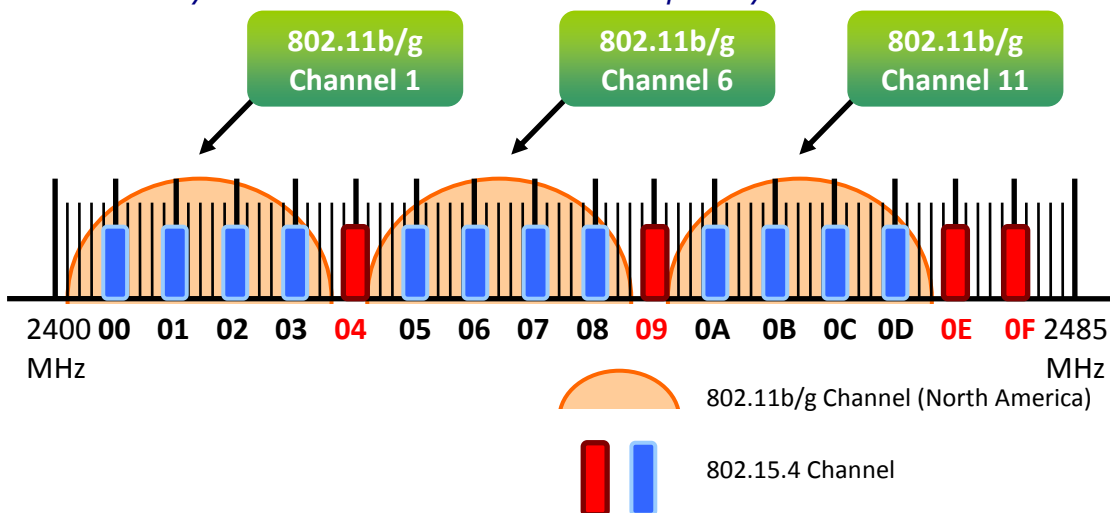

4. "RF Power" denotes the wireless transmit power value.

Code	Note
0x0F	Typical Maximum (Default)
0x00	Typical Minimum

5. "Baud rate & Data Format" serial port settings are supported by ZT-USB series.

Item	Specification
Parity	None(Default), Odd, Even
Data Bit	8
Stop Bit	1
Baud rate	2400, 4800, 9600, 19200, 38400, 57600, 76800 and 115200(Default) bps

6. Communication Speed (The Interval Time of Sending Broadcast Frame):

The data payload of ZT-2000 and ZT-USB series modules is 79 bytes. Once the data is more than 79 bytes, it will be divided into several packets. This parameter is used to decide the interval time of sending broadcast frame in order to prevent the network crashes. Please fill in the number of ZT-2000 slaves nearby the ZigBee Coordinator. More information is in the user manual.

➤ Example:

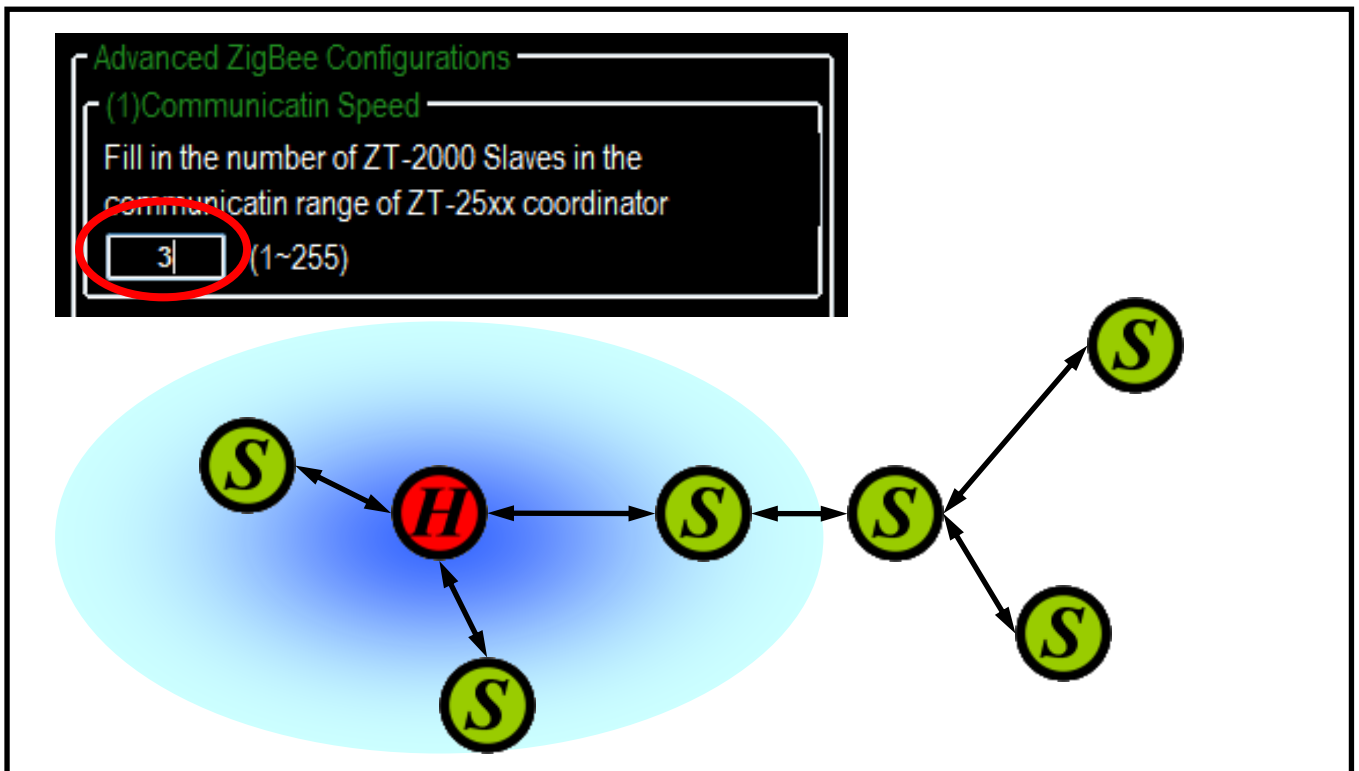

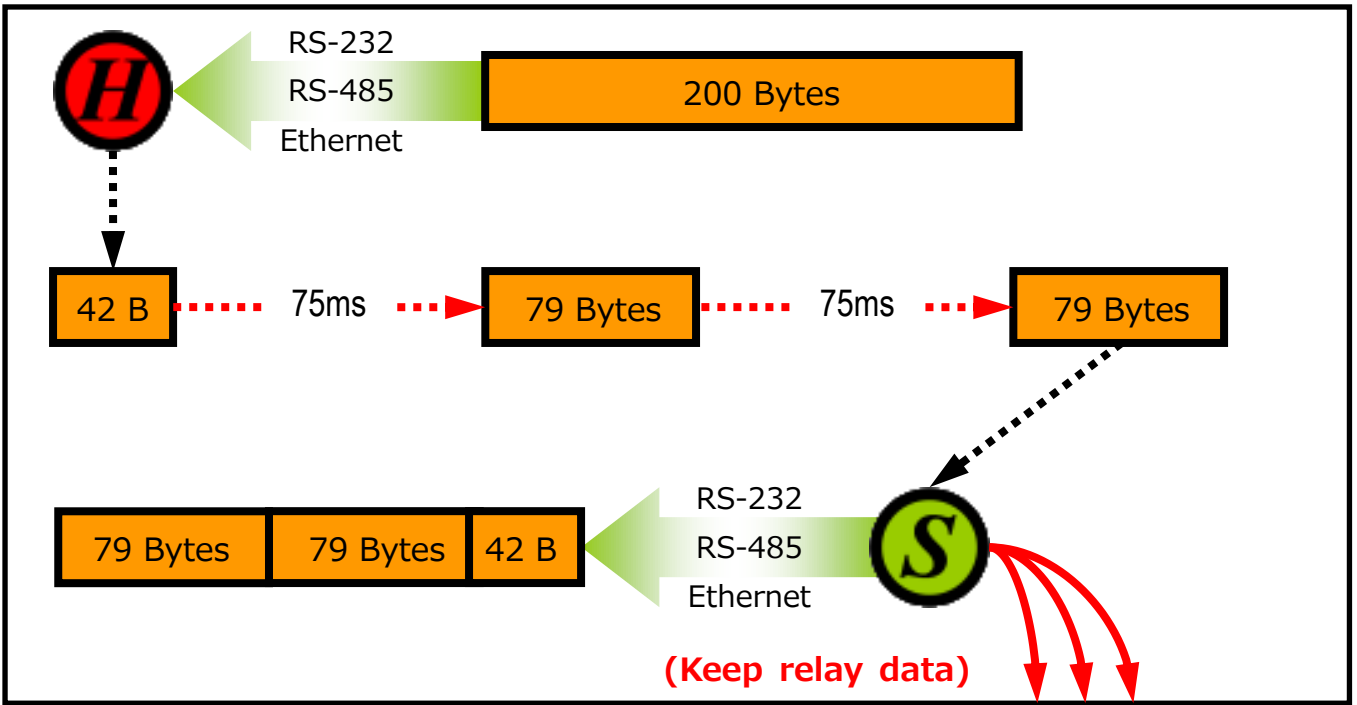

7. Data Transmission:

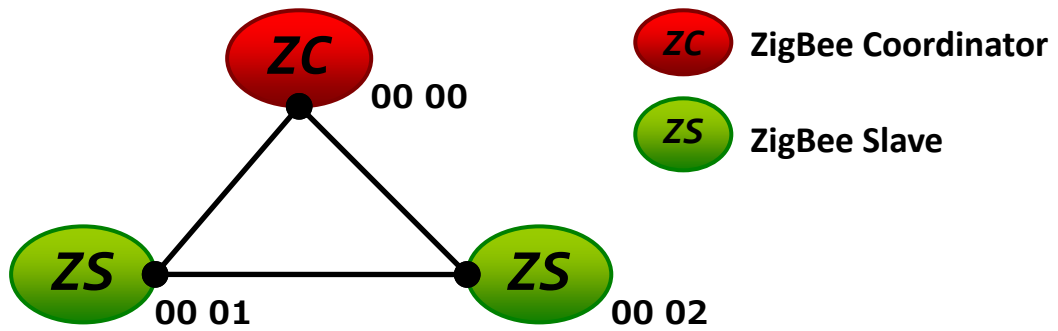

The above schematic diagram is showing ZT-USB series application mode, and it always transmits data to the remote device via broadcasting.

Module	Frame Type	Note
ZT-USBC	Broadcast	Data will be sent to all ZigBee slaves

[Eg1] When ZT-USBC (ZigBee Host) sends "DATA_01" via broadcasting frame,
 → Both of the ZigBee slave 0x0001 and 0x0002 will receive the "DATA_01".
 ※Broadcasting type frame, data will be sent to every ZigBee slaves in the same ZigBee network

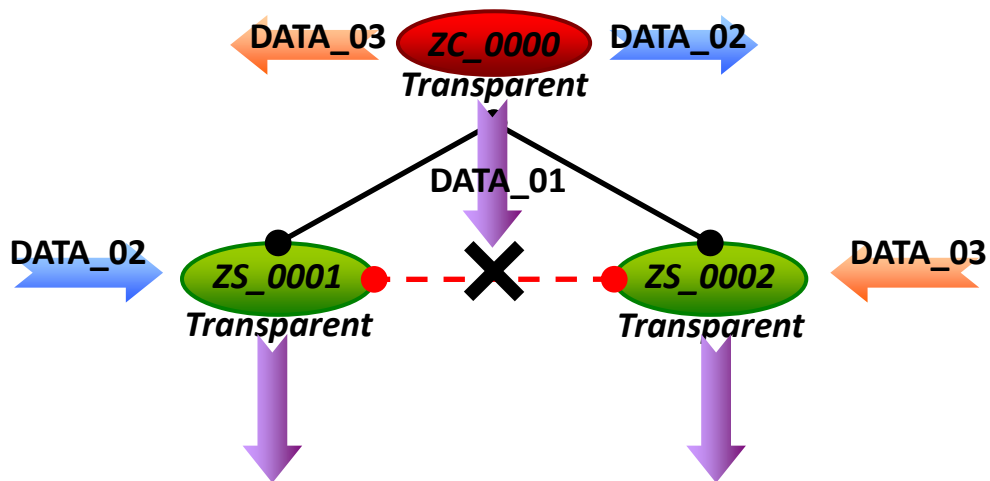

5.2 Configuring ZigBee Setting

1. Launch the "ZT Configuration Utility" and click the [ZT Series] button.



2. Click the [Serial Port] icon and then select the COM Port number.

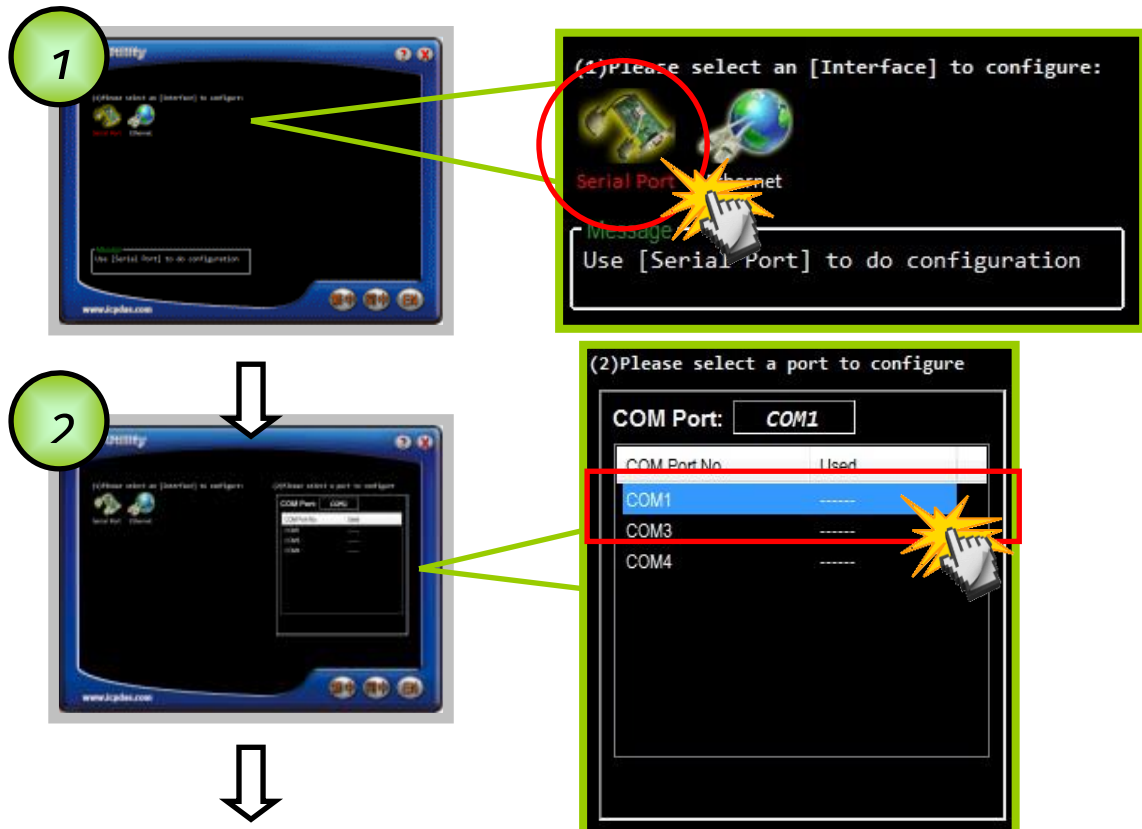

3. After selecting the COM Port number, a list of model numbers will be displayed. Select the name of the module that you want to configure. After clicking the button, the utility will begin checking the connection.



4. Choose serial baud rate and data format. The default setting is 115200bps and N, 8, 1.

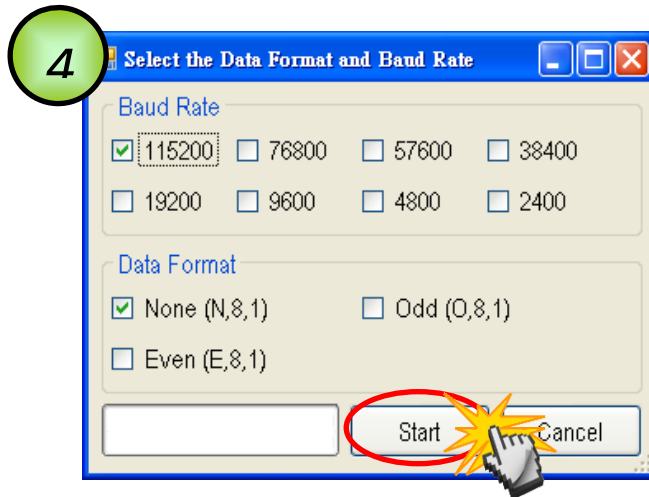

5. Once a connection is established, select either the [Default] or the [Wizard] function from the settings mode page.

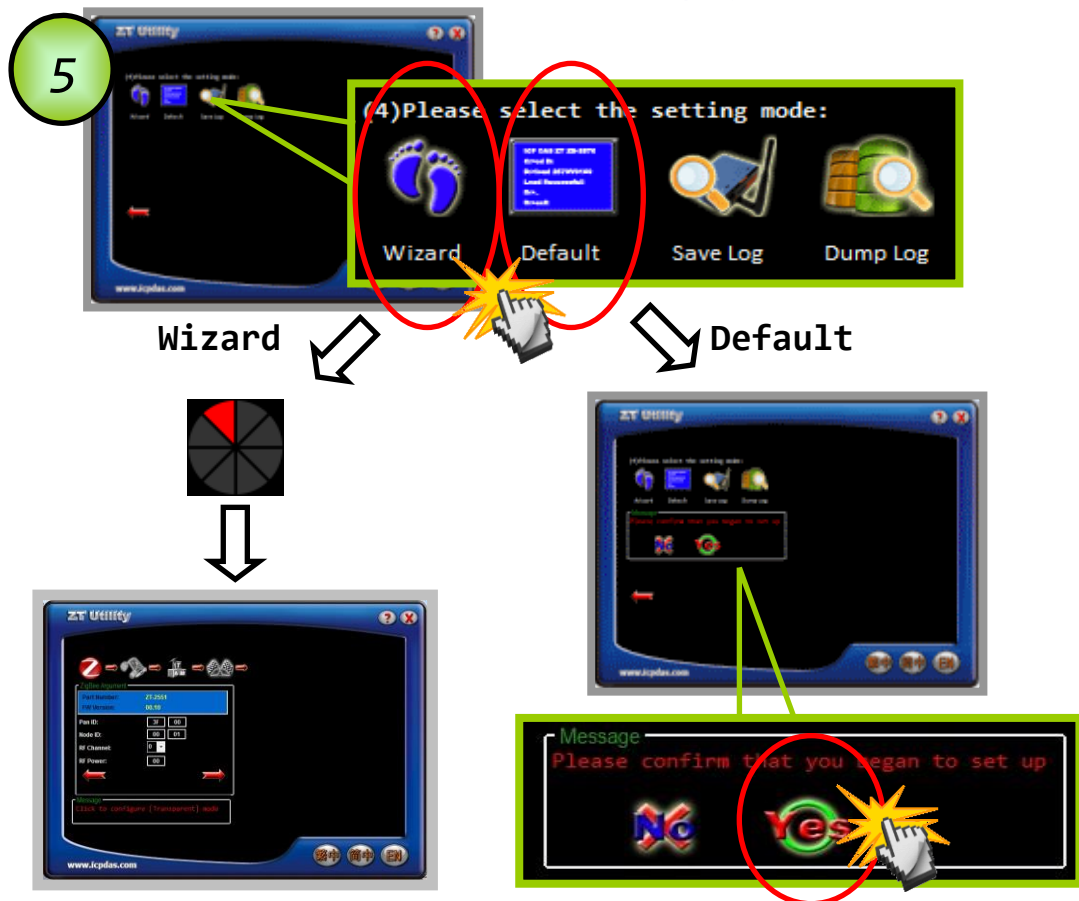

6. Whether you select either the [Default] or the [Wizard] option for performing configuration, both are used to configure the Pan ID, Node ID, RF Channel, RF Power, Baud rate, Data Format, Application Mode and so the relevant parameters.



7. Setting Pan ID/Node ID/RF Channel. For more details, please see section 5.1.

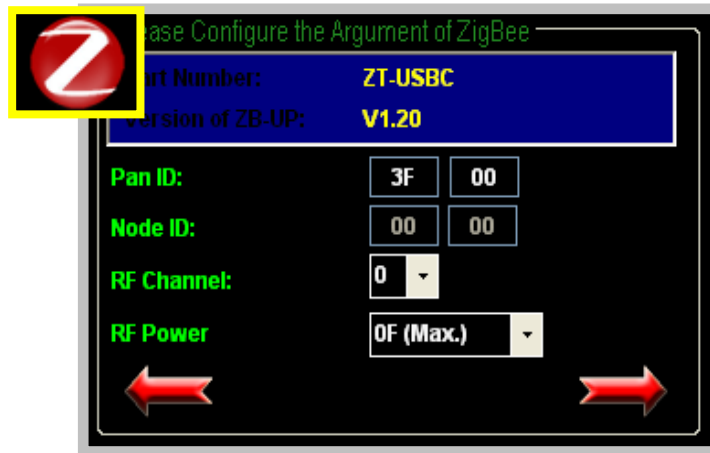

8. Baud Rate and Data Format

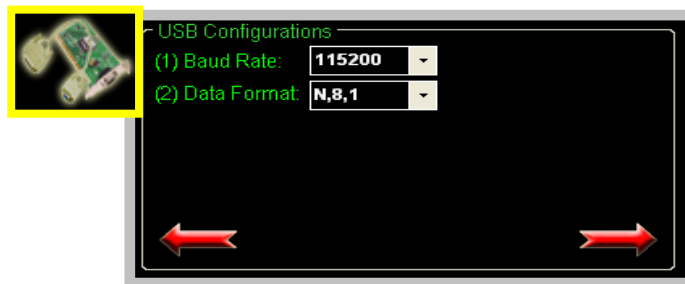

9. Once the module configuration has been completed, the message "The Configuration was successful" will be displayed.

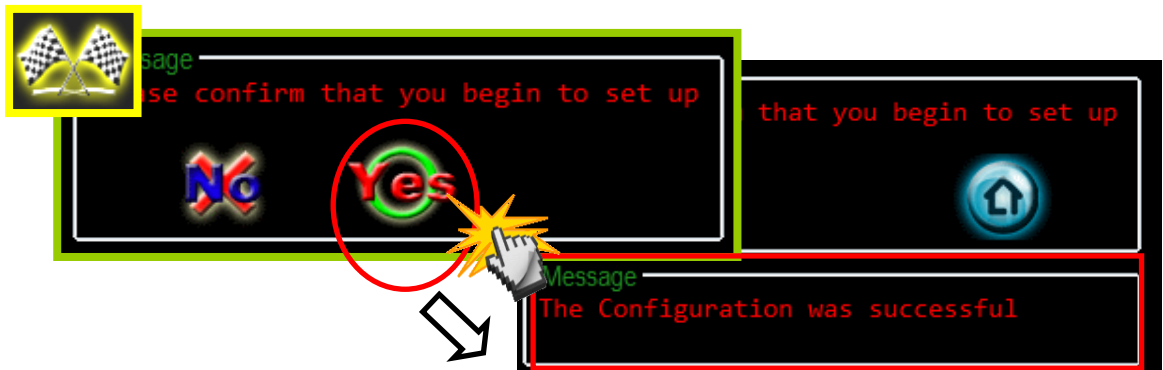

5.3 Test Communications

Method (1)

Connect both the ZT-USBC and ZT-2551 to the Host PC via the USB and RS-232. You may need to use two serial port tools to simulate the data transmission.

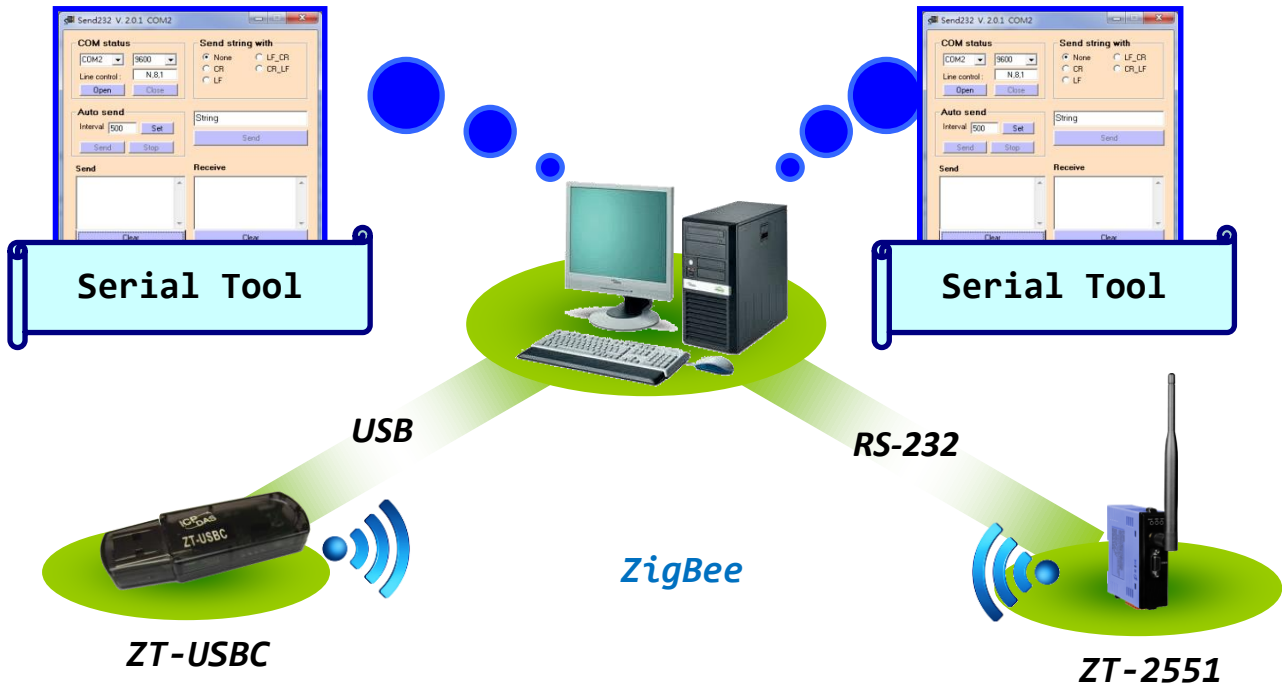

Method (2) :

Use the DCON Utility on the Host PC to search for ZT-2000 series I/O modules. If there any devices are found, it means that the configuration is correct.



5 Applications

We are dedicated to develop ZT-USB series in smart energy, home automation, health care and any other I/O nodes in low data rate communication.

- (1) ZT-USB series are able to be integrated into SCADA easily. If you choose ICP DAS ZT-2000, you can implement monitoring and controlling right away.

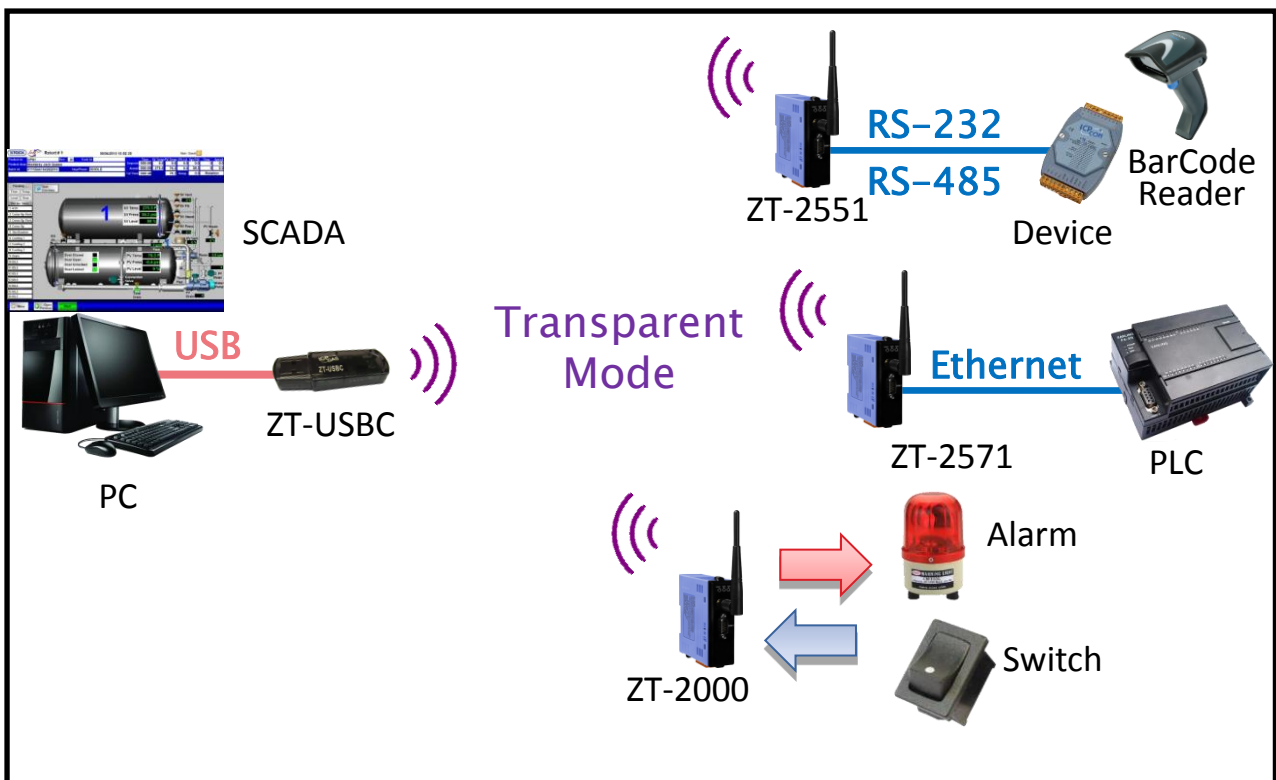

6 Troubleshooting

6.1 Technical Support

If you have any difficulties using your ZT-USB series module, please send a description of the problem to service@icpdas.com. Please the following items,

- A description to the communication protocol for more information.
 - A copy of the configuration file for the ZT-USB series module. This file can be obtained using the procedure outlined below and should be attached to your email.
- a. Launch the ZT Configuration Utility and select [Save Log] icon to save the configuration of the ZT-USB Series as a file.



- b. After clicking the [Save Log] icon, enter the "File Name" and the "File Path" in the Windows "Save" dialog box. Once the configuration has been successfully saved, the following message will be displayed.

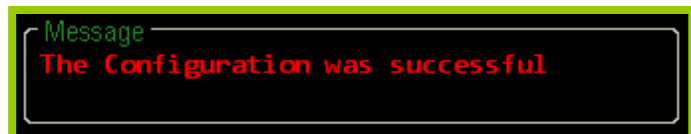
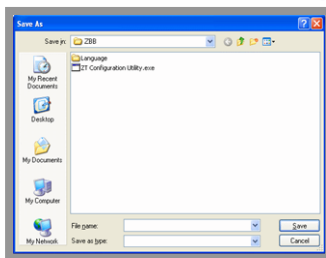

6.2 LED Indicator Status

LED Indicator	Status	Introduction
ZigBee Net (RedLED)	ZigBee Coordinator (Host)	
	Steady Lit	ZigBee network is Establish
	Blink to Steady Lit	Rejoin ZigBee Network or It has Occupied
	ZigBee Router (Slave)	
	Steady Lit	The Signal is Strong
	Blinking (500 ms)	The Signal is Available
	Blinking (1s)	The Signal is Weak
	Blinking (2s)	The Signal is Unstable or There is no Available