



## IR-712A/IR-712A-5

Universal IR Learning Module  
(2 x IR outputs, 224 x IR cmds)

### Features

- 2 IR output channels.
- 1 IR learning input.
- Supports 6 IR carrier frequencies: 33, 36, 37, 38, 40 and 56 kHz.
- IR command capacity: 224
- Supports RS-232 and RS-485 serial interface.
- Supports Modbus RTU protocol to emit IR commands.
- Provides ASCII String Command (DCON protocol) to emit IR commands.
- Provides API library for users' program development easily.
- Built-in Watchdog.
- RoHS Compliance.



### Introduction

IR-712A is a universal IR learning remote module which can learn IR remote commands of diverse electronic devices. The learning commands can be stored in the module or saved to a file. IR-712A supplies 2 IR output channels for individual and simultaneous control on multiple devices. The accompanied RS-232 and RS-485 interfaces with Modbus RTU and DCON protocols provide more flexible expansion and control on the module. As a replacement of IR remote controls and a module that can be easily integrated with Modbus master devices (e.g. PAC, PLC, PC... etc.), IR-712A is well-suited for smart home and building automation.

### Applications

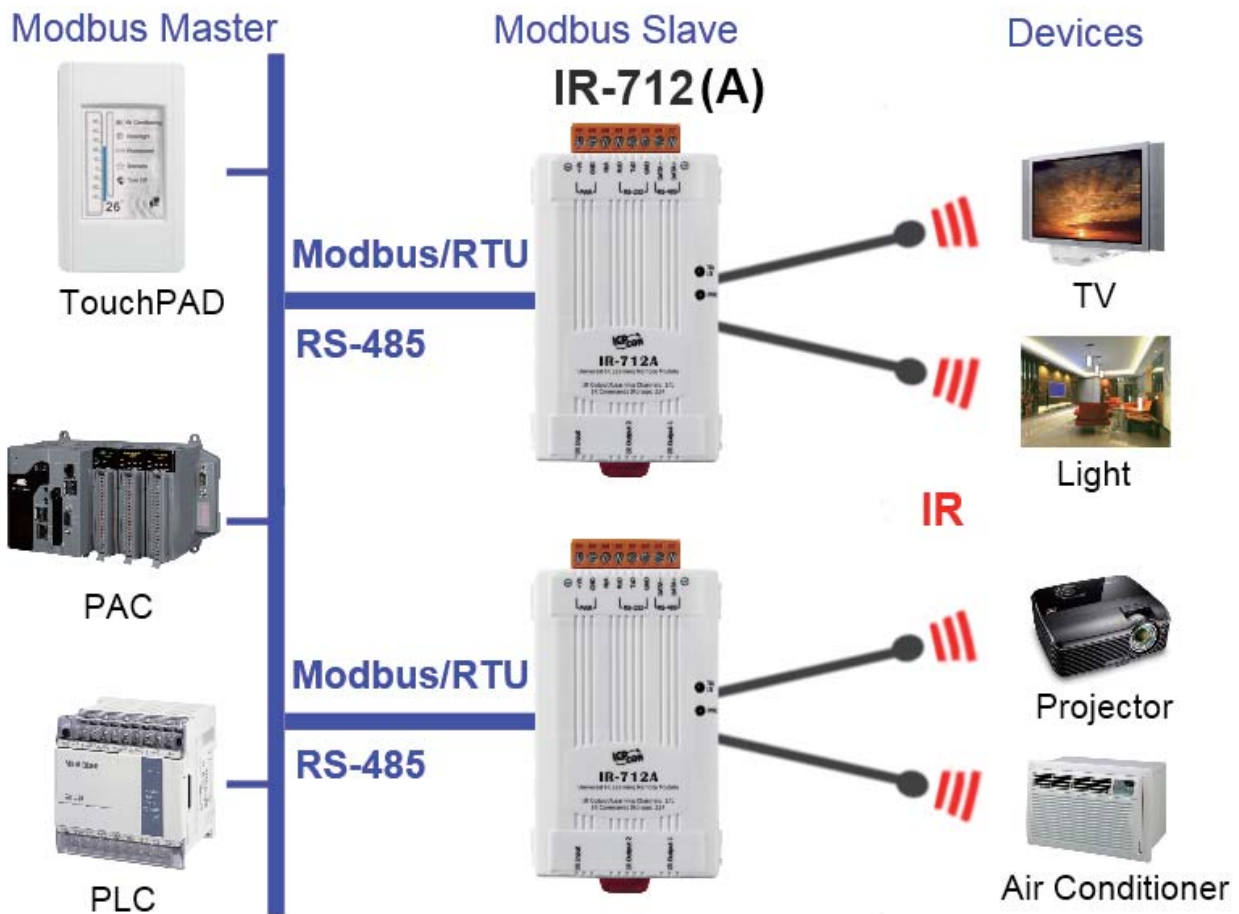

## Specifications

IR Interface			
IR Output Channels	2 channels with 3.5 mm audio jack		
IR Learning Input	1 channel. Supports 6 IR carrier frequencies: 33, 36, 37, 38, 40, 56 kHz.		
IR Command Storage	224 IR Commands		
Serial Communication Interface			
Connector	8-pin (RS-485, RS-232, and Power) screw terminal connector		
COM1 / COM2	RS-232 (TxD, RxD, GND) / RS-485 (DATA+, DATA-)		
Baud Rate	9600, 19200, 38400, 57600, 115200 bps		
Protocol	Modbus RTU / DCON (slave)		
LED Indicator			
LED	2 LEDs: TR/LN (IR Transmitting/Learning) and PWR (Power)		
Power			
Power Supply	+10 ~ +30 V <sub>DC</sub>		
Power Consumption	Stand by: 0.6 W	1 IR output used: 2.3 W	2 IR outputs used: 4 W (Max.)
Mechanism			
Installation	DIN-Rail Mounting		
Dimensions	52 mm x 27 mm x 93 mm (W x L x H)		
Dip Switch	FW (Firmware update mode) / OP (Firmware operation mode)		
Environment			
Operating Temp.	-25 ~ +75°C		
Storage Temp.	-30 ~ +80°C		
Humidity	10 ~ 90% RH, non-condensing		



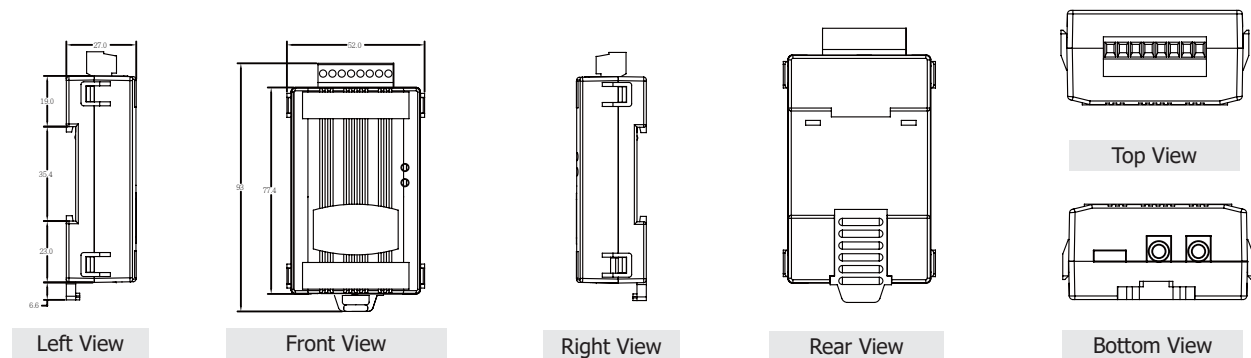

## Dimensions (Units: mm)



## Ordering Information

<b>IR-712A CR</b>	Universal IR Learning Module (2 x IR outputs, 224 x IR cmds) (RS-232, RS-485), with 2 x CA-IR-SH2251 emitter cables (RoHS)
<b>IR-712A-5 CR</b>	Universal IR Learning Module (2 x IR outputs, 224 x IR cmds) (RS-232, RS-485), with 2 x CA-IR-SH2251-5 emitter cables (RoHS)

## Accessories

<b>CA-IR-SH2251</b>		Single-headed IR emitter (with adhesive pad, Ø 3 mm IRED, 2.5 m)
<b>CA-IR-SH2252</b>		Dual-headed IR emitter (with adhesive pad, Ø 3 mm IRED, 2.5 m)
<b>CA-IR-SH2251-5</b>		Single-headed IR emitter (with adhesive pad, Ø 5 mm IRED, 2.5 m)
<b>CA-IR-SH2252-5</b>		Dual-headed IR emitter (with adhesive pad, Ø 5 mm IRED, 2.5 m)
<b>CA-IR-SH2251-360</b>		Semi-sphere-headed IR blaster cable (with adhesive pad, 2.5 m)