



I-8135W

5 埠 10/100 Mbps 快速乙太網路交換器模組

特色

- 5 RJ-45 乙太網路埠
- 每埠皆支援速度 10/100 Mbps 和自動協商 (auto negotiation)
- 全雙工 IEEE 802.3x 和半雙工背壓 (backpressure) 流量控制
- 隨插即用的自動 MDI/MDI-X 跳接網路線
- 3.2 Gbps 高效內存記憶體頻寬
- 512 KB 幀緩衝存儲器



介紹

I-8135W 是一具靈活、高效的 5 埠乙太網路模組、支援多種 PAC (XPAC、WinPAC、LinPAC、iPAC、ViewPAC 等) · 可直接從 PAC 背板獲取電源，不再需要額外的電源。在 PAC 解決方案中，如果想擴展乙太網路的連接，I-8135W 常規的乙太網交換器是很好地替代方案，不僅可以節省安裝空間和省去電源适配器的需要。

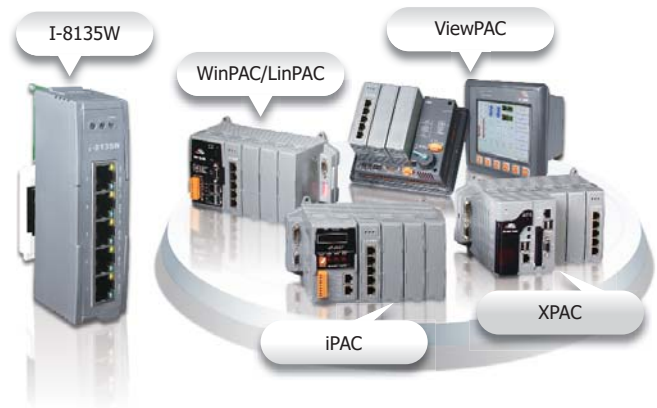

規格

Technology	
Standards	IEEE 802.3, 802.3u, 802.3x
Processing Type	Store & forward, wire speed switching
MAC Addresses	1024
Memory Bandwidth	3.2 Gbps
Frame Buffer Memory	512 Kbit
Flow Control	IEEE802.3x flow control, back pressure flow control
Ethernet Switch	No external software required (for iP-8000, WP-8000, XP-8000, VP-23/25W)
Interface	
LED Indicators	1 LED as power indicator; 10 LEDs as speed and Link/Act indicators
Redundant Power	
Power Consumption	3 W
Mechanical	
Dimensions (W x L x H)	30 mm x 82 mm x 114 mm
Environment	
Operating Temperature	-25 °C ~ +75 °C
Storage Temperature	-40 °C ~ +85 °C
Ambient Relative Humidity	10% ~ 90% RH, Non-condensing

I/O 內部結構

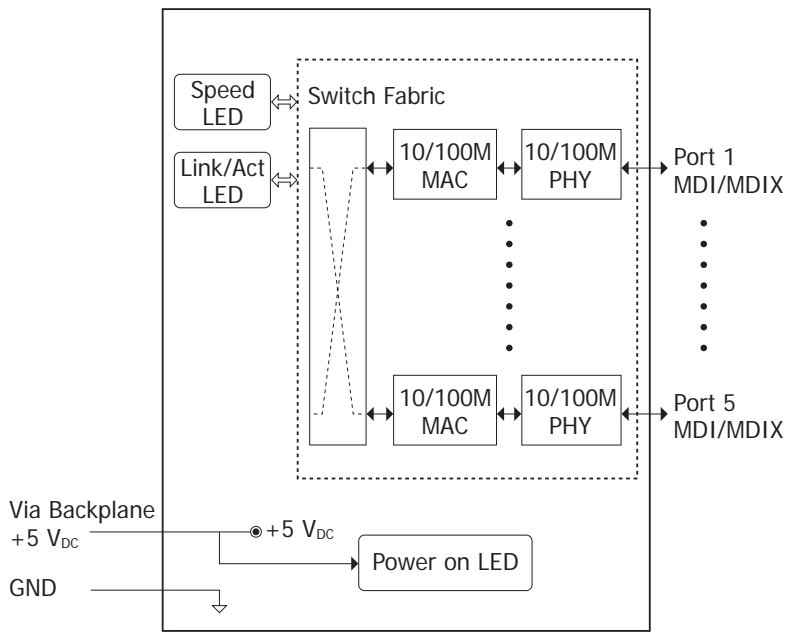

接線圖

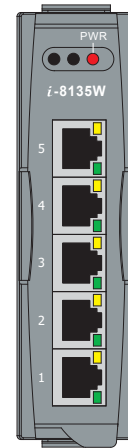

LED	Color	Description
PWR	Red	Power is ON
	Off	Power is Off
10/100M (Port 1)	Green	Link/Act
	Yellow	10/100M
10/100M (Port 2)	Green	Link/Act
	Yellow	10/100M
10/100M (Port 3)	Green	Link/Act
	Yellow	10/100M
10/100M (Port 4)	Green	Link/Act
	Yellow	10/100M
10/100M (Port 5)	Green	Link/Act
	Yellow	10/100M

應用

PAC 搭配 NS-205

(一般搭配標準 Ethernet Switch 應用)

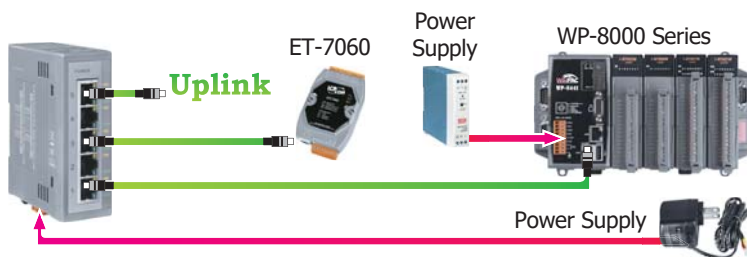

PAC 搭配 I-8135W

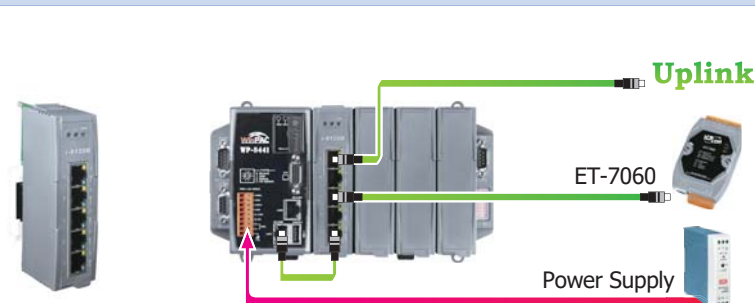

尺寸 (Unit: mm)

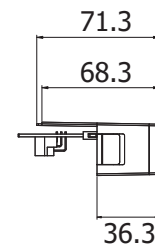

上視角

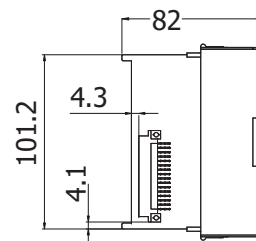

左視角

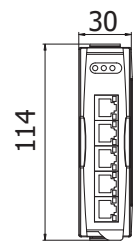

前視角

訂購資訊

I-8135W-G CR

5 埠 10/100 Mbps 快速乙太網路交換器模組 (RoHS)