

# I-7580 User Manual

Version 1.00, May 2014

## **Warranty**

---

All products manufactured by ICP DAS are under warranty regarding defective materials for a period of one year, beginning from the date of delivery to the original purchaser.

## **Warning**

---

ICP DAS assumes no liability for any damage resulting from the use of this product. ICP DAS reserves the right to change this manual at any time without notice. The information furnished by ICP DAS is believed to be accurate and reliable. However, no responsibility is assumed by ICP DAS for its use, not for any infringements of patents or other rights of third parties resulting from its use.

## **Copyright**

---

Copyright © 2014 by ICP DAS Co., Ltd. All rights are reserved.

## **Trademark**

---

The names used for identification only may be registered trademarks of their respective companies.

## **Contact US**

If you have any problem, please feel free to contact us.  
You can count on us for quick response.

Email: [service@icpdas.com](mailto:service@icpdas.com)

I-7580 User Manual (Version 1.00, May/2014)

Copyright © 2014 ICP DAS Co., Ltd. All Rights Reserved. E-mail: [service@icpdas.com](mailto:service@icpdas.com)

# Table of Contents

---

|                                                             |           |
|-------------------------------------------------------------|-----------|
| <b>Table of Contents .....</b>                              | <b>3</b>  |
| <b>1. Introduction .....</b>                                | <b>5</b>  |
| 1.1. Features .....                                         | 6         |
| 1.2. Specification .....                                    | 7         |
| 1.3. Internal I/O Structure .....                           | 9         |
| 1.4. Pin Assignment.....                                    | 10        |
| 1.5. Overview .....                                         | 12        |
| 1.6. Wiring and Jumper Setting Instructions .....           | 16        |
| 1.6.1. RS-232 Connection .....                              | 16        |
| 1.6.2. RS-422 Connection .....                              | 17        |
| 1.6.3. RS-485 Connection .....                              | 18        |
| 1.7. Dimensions.....                                        | 19        |
| <b>2. PROFINET .....</b>                                    | <b>20</b> |
| 2.1. Device classes of PROFINET IO.....                     | 20        |
| 2.2. Device Description.....                                | 21        |
| 2.3. Conformance Classes (CC).....                          | 22        |
| <b>3. Basic Application .....</b>                           | <b>23</b> |
| 3.1. Connect to Network, PC and PROFINET IO controller..... | 23        |
| 3.2. Network configuration.....                             | 24        |
| 3.3. GSD Import .....                                       | 32        |
| 3.4. Project Setup.....                                     | 34        |
| <b>4. Communication .....</b>                               | <b>42</b> |
| 4.1. Communication Sequence .....                           | 42        |

|                                                                                |           |
|--------------------------------------------------------------------------------|-----------|
| 4.2. Module configuration .....                                                | 44        |
| 4.3. Module Parameter Settings .....                                           | 45        |
| 4.4. PROFINET Input Data Area.....                                             | 47        |
| 4.5. PROFINET Output Data Area.....                                            | 50        |
| 4.6. Diagnostic Messages .....                                                 | 54        |
| 4.7. Communication test - Receive.....                                         | 55        |
| 4.8. Communication test - Transmit.....                                        | 56        |
| <b>5. MiniOS7 Utility Tool.....</b>                                            | <b>57</b> |
| 5.1. Installing the MiniOS7 Utility.....                                       | 57        |
| 5.2. Using MiniOS7 Utility to get Ethernet settings and firmware version ..... | 58        |
| <b>6. PFN_Tool Utility.....</b>                                                | <b>60</b> |
| 6.1. Installing the PFN_Tool Utility .....                                     | 60        |
| 6.2. PFN_Tool Utility Functionalities .....                                    | 61        |
| 6.2.1. Module Search .....                                                     | 61        |
| 6.2.2. Module Basic Configuration.....                                         | 62        |
| 6.2.3. Module Advanced Configuration.....                                      | 64        |
| <b>7. Configuration with Web Browser.....</b>                                  | <b>69</b> |
| 7.1. Connecting to Web Server .....                                            | 69        |
| 7.2. Web Configuration.....                                                    | 70        |
| <b>8. Troubleshooting .....</b>                                                | <b>75</b> |

# 1. Introduction

---

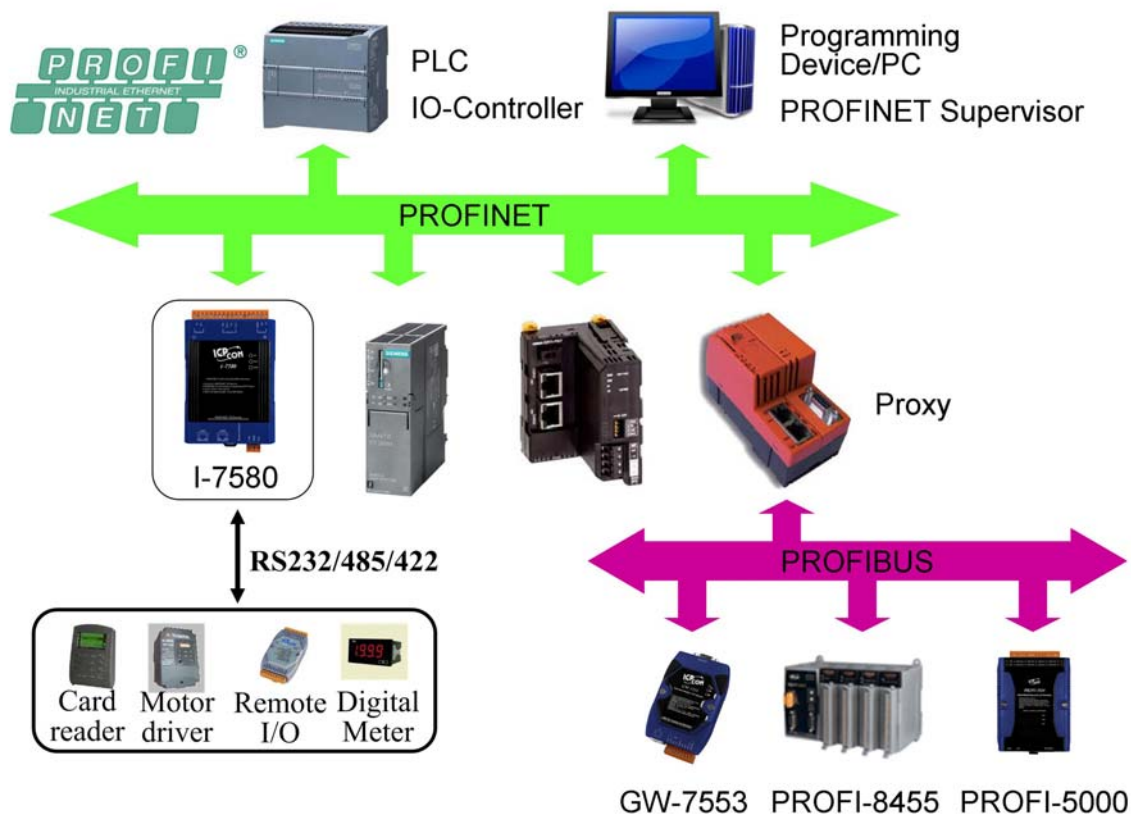

PROFINET is an open Industrial Ethernet standard developed by the PROFIBUS Organization (PI). Based on Ethernet versatility, PROFINET make vertical integration of field level with Enterprise level easily. PROFINET is automation in real time, so it can cover all requirements of the Automation Industry. PROFINET is fit for factory automation, process automation, safety applications and motion control applications, etc.

PROFINET contains 2 different solutions. They are PROFINET IO and PROFINET CBA (Component Based Automation). I-7580 module are PROFINET IO device. The user can access and configure the modules easily by using the GSDML file in any PROFINET Engineering tool, and exchange process data quickly with the IO controller.

I-7580 User Manual (Version 1.00, May/2014)

## 1.1. Features

- ◆ **Transfer protocol: PROFINET IO**
- ◆ **Supported Ethernet services: ICMP, IGMP, ARP, DHCP, TELNET, TFTP, SNMP, VLAN Priority Tagging**
- ◆ **Supported PROFINET services: RTC, RTA, CL-RPC, DCP, LLDP, I&M**
- ◆ **PROFINET Conformance Class B and RT Class 1**
- ◆ **Cyclic Time: 1ms (min)**
- ◆ **Generic GSDML File Provided**
- ◆ **Max. Input / Output data :512 / 384 bytes**
- ◆ **Max transmission speed up to 460800 bps for COM port**
- ◆ **COM port driver has 10 KB QUEUE input buffer & 10 KB QUEUE output buffer**
- ◆ **Built-in self-tuner ASIC controller on RS-422/485 port**
- ◆ **Integrated 2-Port Switch**
- ◆ **Automatic MDI / MDI-X Crossover for Plug-and-play**
- ◆ **Provide LED indicators**
- ◆ **Robust, fan less design**
- ◆ **4 kV Contact ESD protection for any terminal**
- ◆ **Wide range of power input (+10 ~ +30 VDC) and operating temperature (-25 ~ +75°C)**

## 1.2. Specification

| Hardware                |                     |
|-------------------------|---------------------|
| <b>CPU</b>              | 32-bit CPU Core     |
| <b>RAM/Flash/EEPROM</b> | 32 MB / 4 MB / 8 KB |
| <b>Watchdog</b>         | CPU built-in        |
| <b>ESD Protection</b>   | 4 kV class A        |

| PROFINET Interface         |                                  |
|----------------------------|----------------------------------|
| <b>Protocol</b>            | PROFINET IO Device               |
| <b>Conformance Classes</b> | Class B                          |
| <b>Services</b>            | RTC, RTA, CL-RPC, DCP, LLDP, I&M |
| <b>Cycle Time</b>          | 1 ms (min)                       |

| Ethernet Interface |                                                                     |
|--------------------|---------------------------------------------------------------------|
| <b>Controller</b>  | 10/100Base-TX Ethernet Controller<br>(Auto-negotiating, Auto_MDIX)  |
| <b>Connector</b>   | RJ-45 x 2 (LED indicators) , Integrated 2-Port<br>Switch            |
| <b>Services</b>    | ICMP, IGMP, ARP, DHCP, TELNET, TFTP,<br>SNMP, VLAN Priority Tagging |

| UART Interface         |                                                                                                                                                         |
|------------------------|---------------------------------------------------------------------------------------------------------------------------------------------------------|
| <b>COM</b>             | RS-232/RS-422/RS-485<br>(can't be used simultaneously)                                                                                                  |
| <b>COM Connector</b>   | 3-pin screwed terminal block (RxD, TxD, GND)<br>4-pin screwed terminal block (RxD+, RxD-, TxD+,<br>TxD-)<br>2-pin screwed terminal block (DATA+, DATA-) |
| <b>Baud Rate (bps)</b> | 1200, 2400, 4800, 9600, 19200, 38400, 57600,<br>115200, 230400, 460800                                                                                  |
| <b>Data bit</b>        | 7, 8                                                                                                                                                    |

|                 |                 |
|-----------------|-----------------|
| <b>Stop bit</b> | 1               |
| <b>Parity</b>   | None, Even, Odd |

| <b>LED Display</b> |                           |
|--------------------|---------------------------|
| <b>Round LED</b>   | AP LED, BOOT LED, ERR LED |

| <b>Power Requirements</b> |                                                                      |
|---------------------------|----------------------------------------------------------------------|
| <b>Power supply</b>       | Unregulated +10 ~ +30 VDC                                            |
| <b>Protection</b>         | Power reverse polarity protection, Over-voltage brown-out protection |
| <b>Power Consumption</b>  | 3.4 W                                                                |

| <b>Mechanical</b>   |                                    |
|---------------------|------------------------------------|
| <b>Dimensions</b>   | 42 mm x 76 mm x 119 mm (W x L x H) |
| <b>Installation</b> | DIN Rail or Wall mounting          |

| <b>Environment</b>           |                             |
|------------------------------|-----------------------------|
| <b>Operating Temperature</b> | -25 °C ~ +75 °C             |
| <b>Storage Temperature</b>   | -30 °C ~ +80 °C             |
| <b>Humidity</b>              | 10~ 90 % RH, non-condensing |



### 1.3. Internal I/O Structure

I-7580 Internal I/O Structure

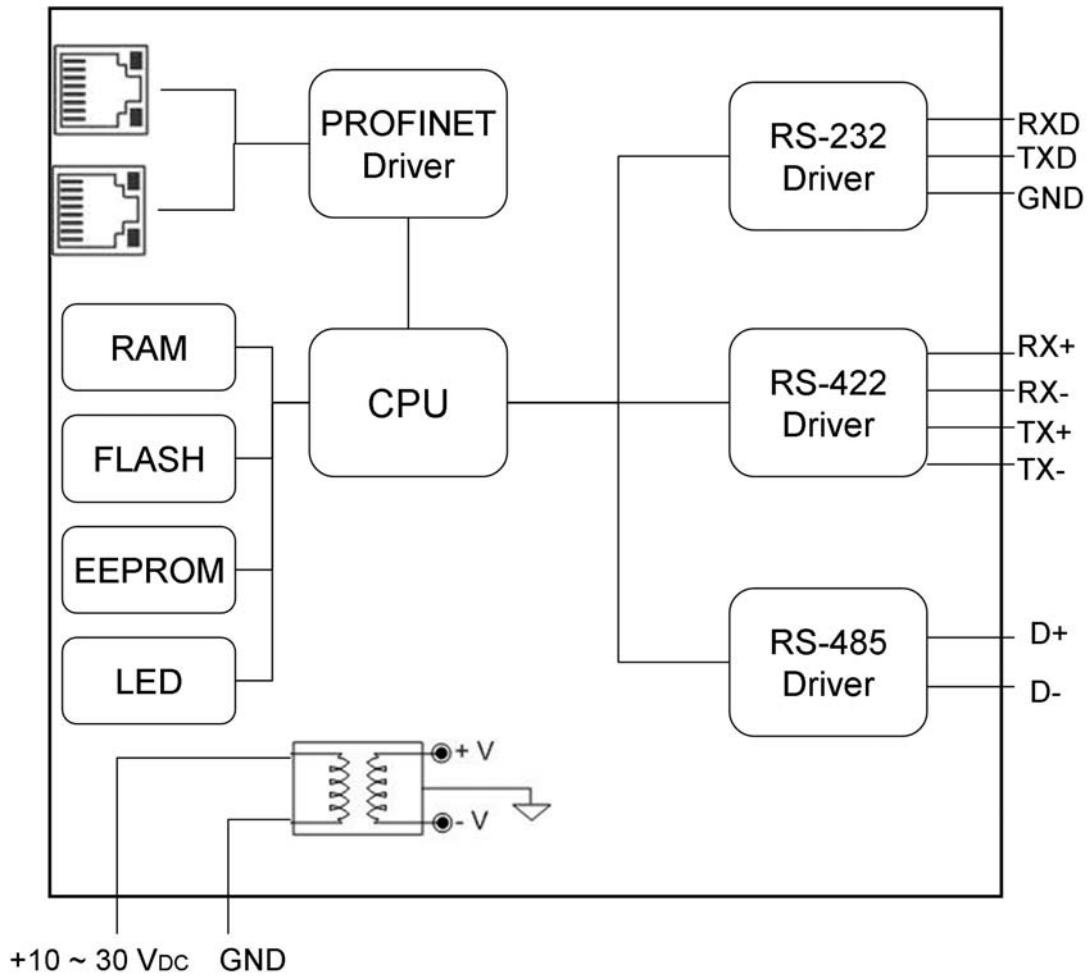

## 1.4. Pin Assignment

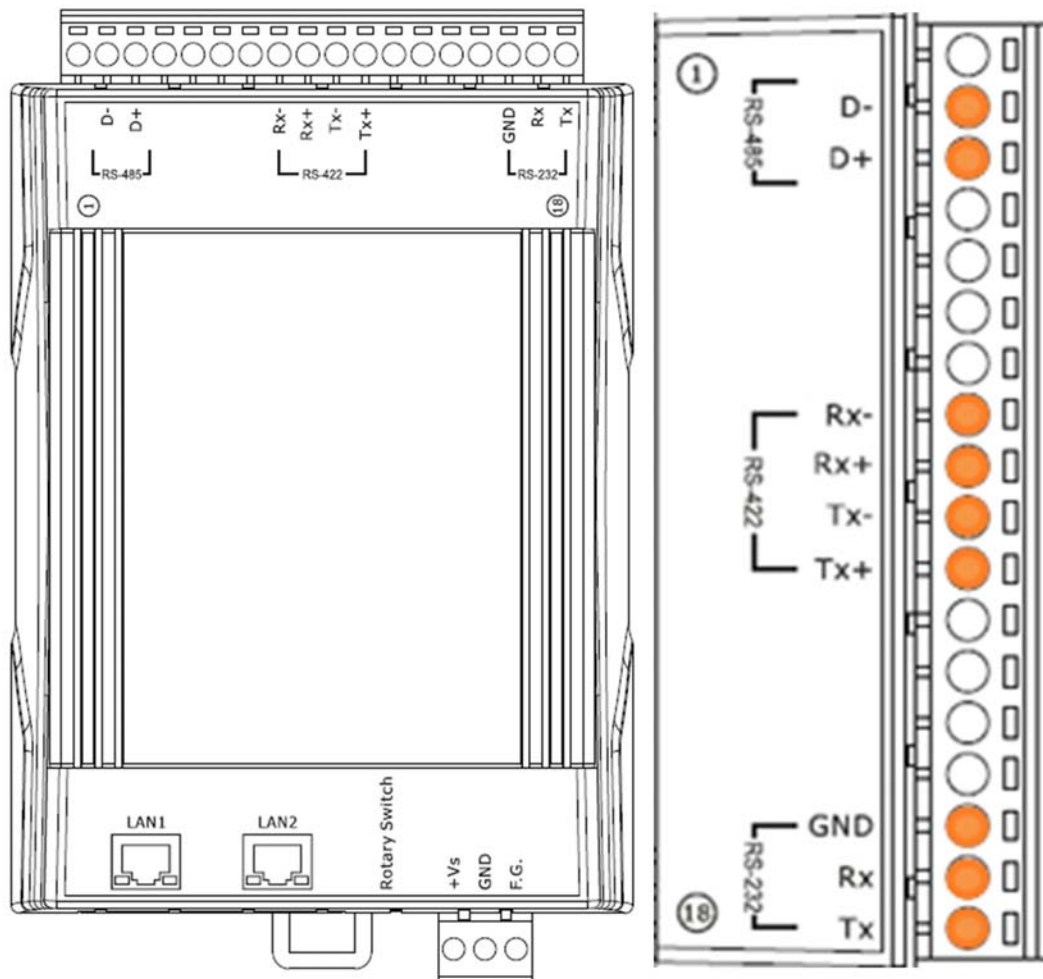

| Pin | Name | Description             |
|-----|------|-------------------------|
| 1   | -    | N/A                     |
| 2   | D-   | Data- of RS-485         |
| 3   | D+   | Data+ of RS-485         |
| 4   | -    | N/A                     |
| 5   | -    | N/A                     |
| 6   | -    | N/A                     |
| 7   | -    | N/A                     |
| 8   | Rx-  | Receive Data- of RS-422 |
| 9   | Rx+  | Receive Data+ of RS-422 |

I-7580 User Manual (Version 1.00, May/2014)

|    |     |                          |
|----|-----|--------------------------|
| 10 | Tx- | Transmit Data- of RS-422 |
| 11 | Tx+ | Transmit Data+ of RS-422 |
| 12 | -   | N/A                      |
| 13 | -   | N/A                      |
| 14 | -   | N/A                      |
| 15 | -   | N/A                      |
| 16 | GND | GND of RS-232            |
| 17 | Rx  | Receive Data of RS-232   |
| 18 | Tx  | Transmit Data of RS-232  |

## 1.5. Overview

Here is a brief overview of the components and its descriptions for module status.

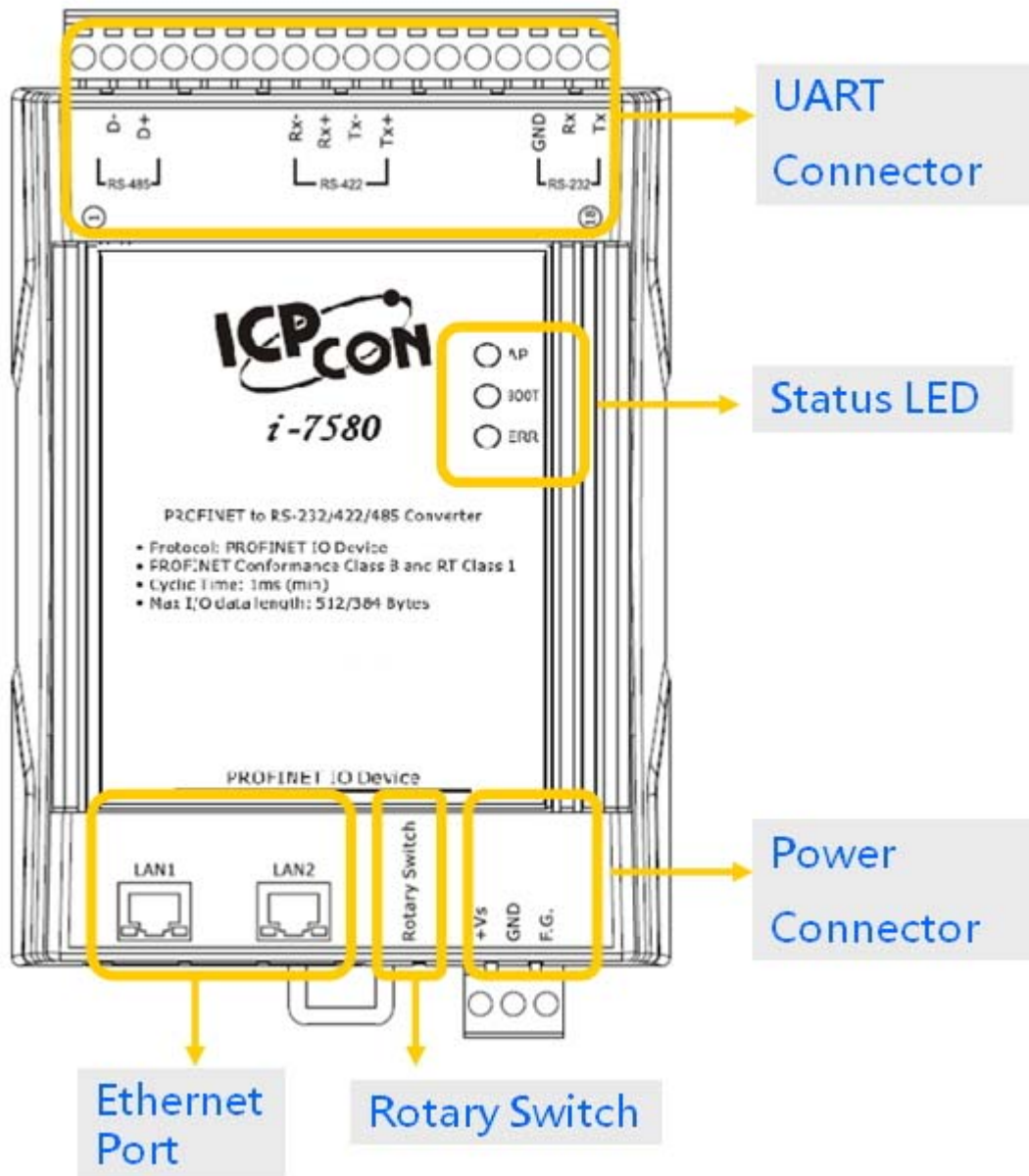

### ► UART Connector

For more detailed information regarding the pin assignments of the UART Connector, please refer to “1.4. Pin Assignment”

## ► Status LED Indicators

---

AP mode:

| AP  | BOOT         | ERR          | Description                                                            |
|-----|--------------|--------------|------------------------------------------------------------------------|
| OFF | OFF          | Flash (Slow) | waiting for PROFINET connection                                        |
| ON  | OFF          | OFF          | PROFINET connection is established.                                    |
| ON  | OFF          | Flash (Slow) | Device is at AP mode and the module received the incorrect parameters. |
| ON  | OFF          | Flash (Fast) | Error! I-7580 has diagnostic message.                                  |
| ON  | Flash (Slow) | Flash (Slow) | Hardware authentication error!                                         |
| ON  | Flash (Fast) | OFF          | COM port is transmitting or receiving data.                            |

Bootloader mode:

| AP  | BOOT | ERR          | Description                                                            |
|-----|------|--------------|------------------------------------------------------------------------|
| OFF | OFF  | Flash (Slow) | waiting for PROFINET connection                                        |
| ON  | OFF  | OFF          | PROFINET connection is established.                                    |
| ON  | OFF  | Flash (Slow) | Device is at AP mode and the module received the incorrect parameters. |
| ON  | OFF  | Flash (Fast) | Error! I-7580 has diagnostic message.                                  |

Flash(Slow) : about 500 ms    Flash(Fast) : about 100 ms

I-7580 User Manual (Version 1.00, May/2014)

## ► Ethernet Ports

---

An Ethernet port is an opening on I-7580 network equipment that Ethernet cables plug into. Ethernet ports accept cables with RJ-45 connectors.

### Tips & Warnings

---



1. When users connect I-7580 and switch, users should not connect LAN1 and LAN2 to switch at the same time, else it will lead to abnormal network.
2. When users connect network devices by daisy chain topology, users can connect these devices in series by LAN1 and LAN2.

## ► Rotary Switch

---

| Position | Mode    | Module configuration                  |
|----------|---------|---------------------------------------|
| 0        | AP mode | Output: 32 bytes<br>Input: 32 bytes   |
| 1        | AP mode | Output: 64 bytes<br>Input: 64 bytes   |
| 2        | AP mode | Output: 128 bytes<br>Input: 128 bytes |
| 3        | AP mode | Output: 256 bytes<br>Input: 256 bytes |
| 4        | AP mode | Output: 384 bytes<br>Input: 384 bytes |
| 5        | AP mode | Output: 384 bytes<br>Input: 512 bytes |
| 6        | AP mode | Reserved                              |
| 7        | AP mode | Reserved                              |

I-7580 User Manual (Version 1.00, May/2014)

|     |                 |     |
|-----|-----------------|-----|
| 8~F | Bootloader mode | N/A |
|-----|-----------------|-----|

## Tips & Warnings

---



If AP LED turn on, BOOT LED turn off and ERR LED flash slow. It means that the value of rotary switch does not match the settings of the modules (please refer to section 4.2. Module configuration).

---

## ► Power Connector

---

| Pin Name | Function                |
|----------|-------------------------|
| +VS      | 10 ~ 30 VDC power input |
| GND      | Ground connection       |
| F.G.     | Frame ground connection |

## 1.6. Wiring and Jumper Setting Instructions

It is recommended to use only one serial port (RS232, RS485 or RS422) of the converter at the same time. The following section describes the necessary steps to be taken to connect one of the three COM port types to a serial device or serial network. The pull high/low resistor of COM port is shown in below.

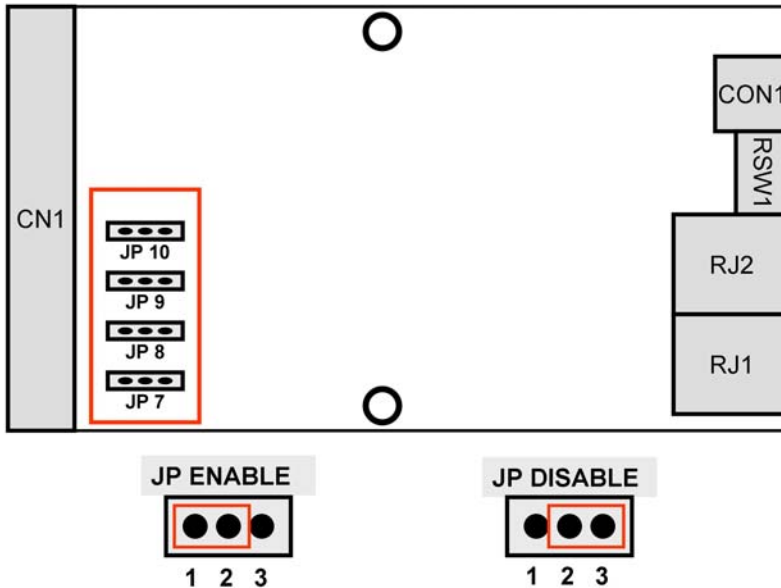

### 1.6.1. RS-232 Connection

The RS-232 port of the I-7580 has got three pins.

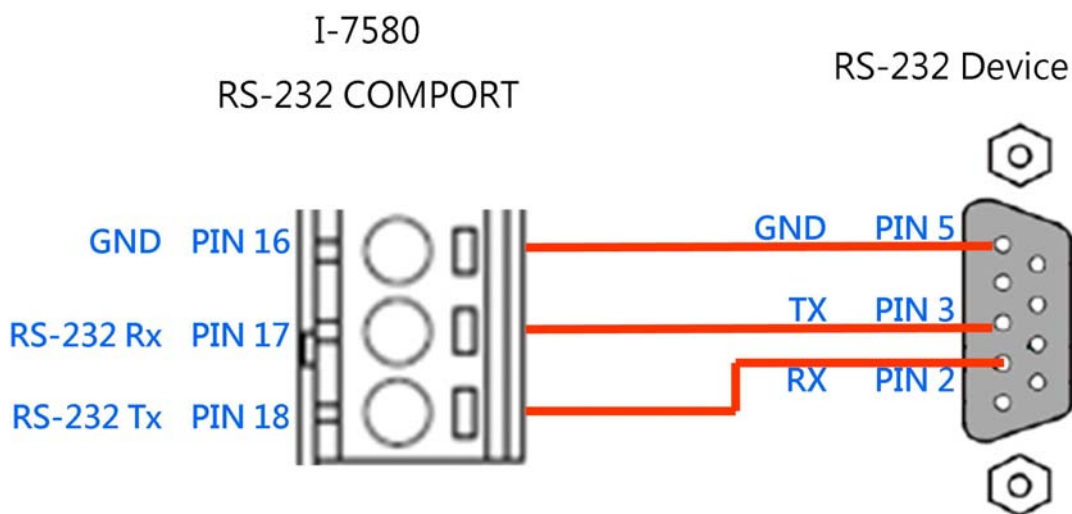



## 1.6.2. RS-422 Connection

The I-7580 converter is always a PROFINET IO device but it can in a local RS-422 network either take the position of a master or that of a slave. Depending on whether the converter acts as a local master or as a slave and on the number of devices connected to the RS-422 network device the four jumpers provided by the module has to be set. The jumpers set the pull high and pull down resistors for the RS-422 port.

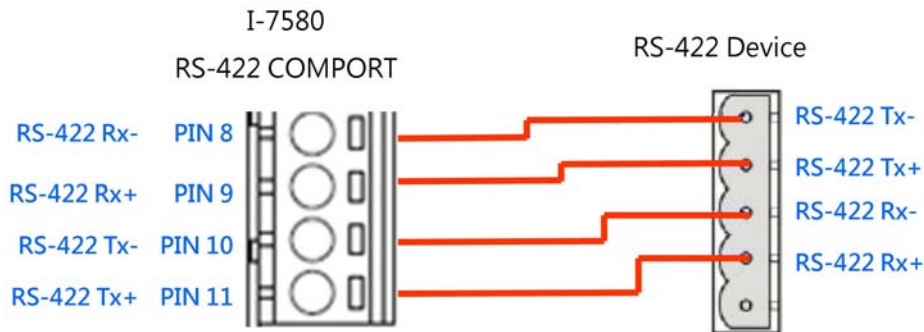

### ► Configuration of pull high/low resistor for the RS-422 port

| Pull High / Low resistor | Condition                                                                                                         |
|--------------------------|-------------------------------------------------------------------------------------------------------------------|
| Enable (default)         | The I-7580 is the master in RS-422 bus<br>or<br>The number of devices connected to the RS-422 bus is less than 10 |
| Disable                  | The I-7580 is a slave in RS-422 bus<br>or<br>The number of devices connected to the RS-422 bus is more than 10    |



### 1.6.3. RS-485 Connection

The I-7580 converter can only act in the PROFINET network as a slave. In a RS-485 network however it can either be a local master or slave. Before the module is connected to a RS-485 network it is important to know whether the module takes the place of a slave or master and how many devices are active on the RS-485 bus. The two jumpers (JP7 and JP8) have to be set according the bus configuration.

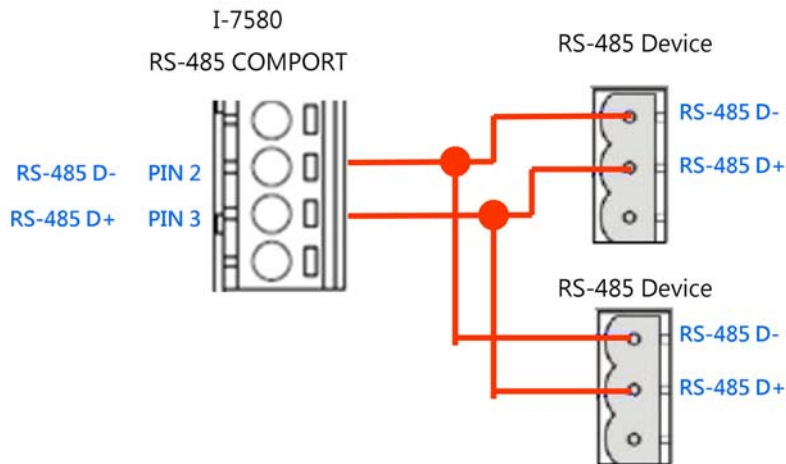

#### ► Configuration of pull high/low resistor for the RS-485 port

| Pull High / Low resistor | Condition                                                                                                         |
|--------------------------|-------------------------------------------------------------------------------------------------------------------|
| Enable (default)         | The I-7580 is the master in RS-485 bus<br>or<br>The number of devices connected to the RS-485 bus is less than 10 |
| Disable                  | The I-7580 is a slave in RS-485 bus<br>or<br>The number of devices connected to the RS-485 bus is more than 10    |

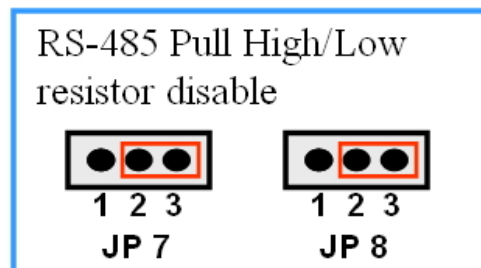
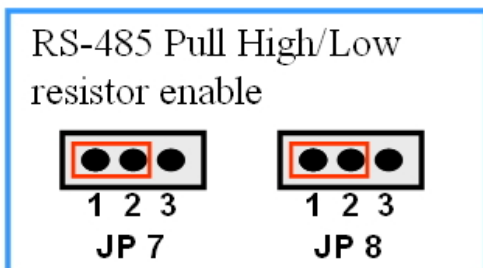

## 1.7. Dimensions

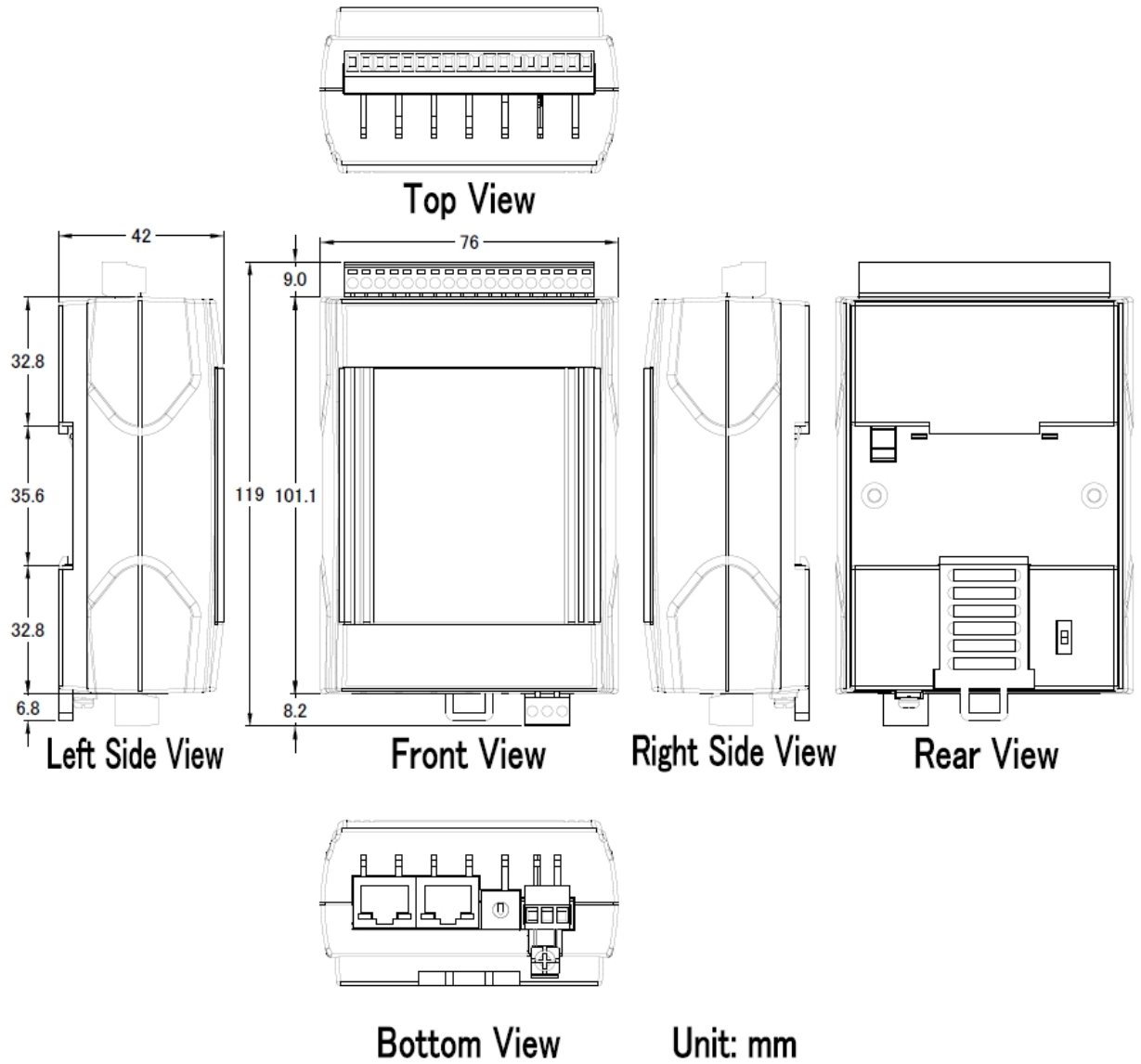

## 2. PROFINET

---

PROFINET contains 2 different solutions. They are PROFINET IO and PROFINET CBA (Component Based Automation). **I-7580 module is a PROFINET IO device.**

PROFINET IO is used for communication with decentral periphery like IOs, drives, etc.

PROFINET CBA is a communication solution for autonomously acting partial units of machines or plants.

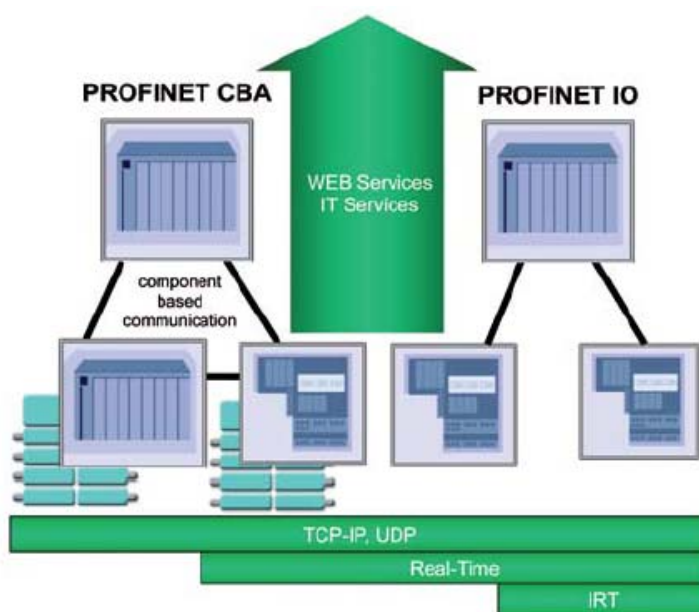

### 2.1. Device classes of PROFINET IO

The following devices classes are defined to facilitate structuring of PROFINET IO field devices.

- ◆ IO-Controller: This is typically a PLC on which the automation program runs
- ◆ IO-Supervisor: This can be a programming device (PG), personal computer (PC), or human machine interface (HMI) device for commissioning or diagnostic purposes.
- ◆ IO-Device: An IO-Device is a distributed I/O field device that is connected via PROFINET IO. It can exchange data with multiple IO-Controllers.

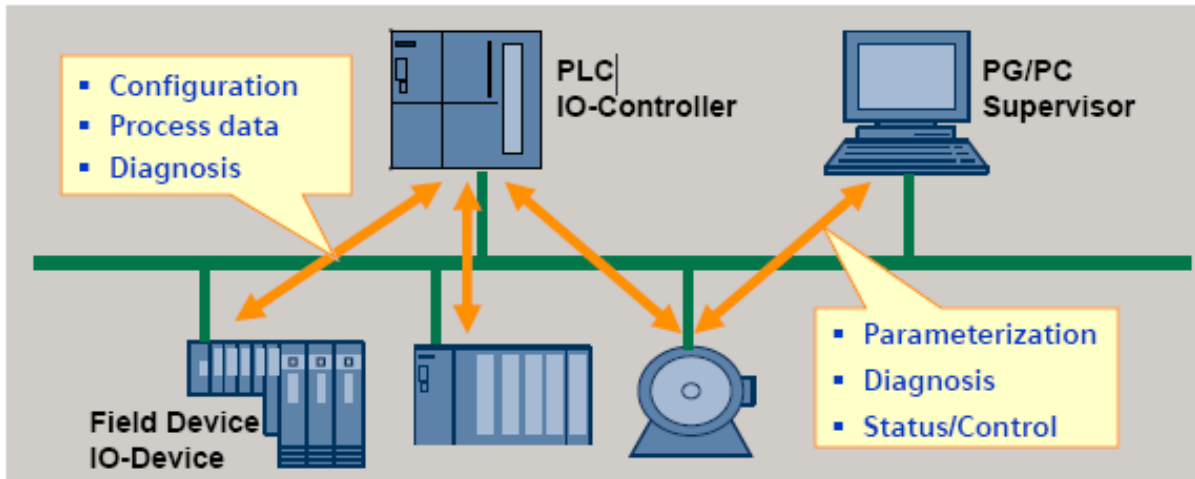

## 2.2. Device Description

The functionality of a PROFINET IO Device is always described in a GSD file. This file contains all data that are relevant for engineering as well as for data exchange with IO-Device.

PROFINET IO-Devices can be described using XML-based GSD. The description language of the GSD file, i.e. GSDML (General Station Description Markup Language) is based on international standards.

Every manufacturer of a PROFINET IO-Device must supply an associated GSD file according to the GSDML specification. Users can access and configure I-7580 module by using the GSDML file in any PROFINET Engineering tool.

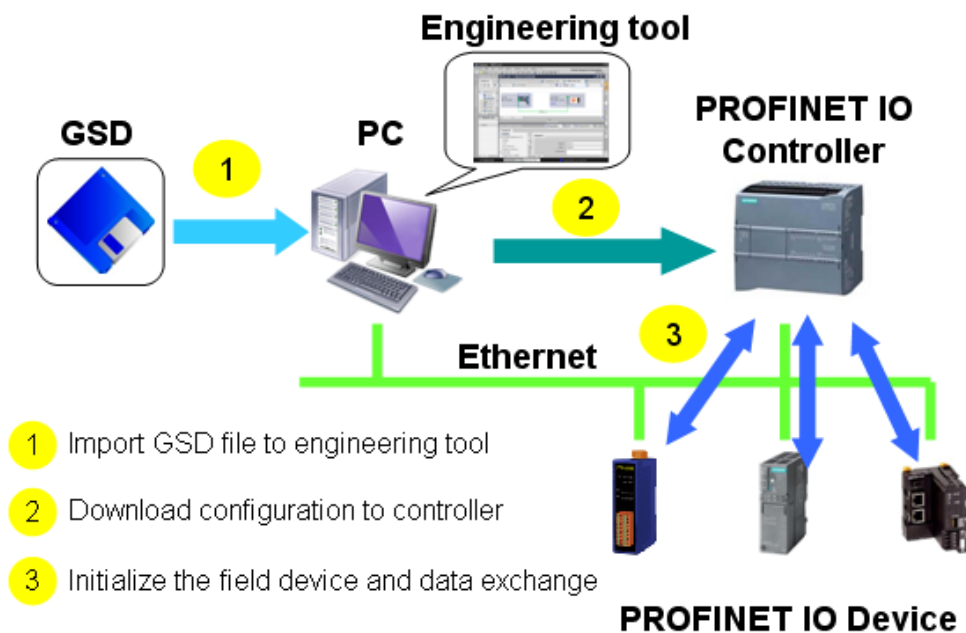

I-7580 User Manual (Version 1.00, May/2014)

## 2.3. Conformance Classes (CC)

PI has classified the scope of functions in PROFINET IO into 3 conformance classes (CC-A, CC-B, CC-C). Users simply need to select a CC appropriate for system and do not need to worry about any other details to ensure the interoperability in an automation system with regard to the scope of functions and performance parameters.

### CC-A:

Use of the infrastructure of an existing Ethernet network including integration of basic PROFINET functionality. All IT services can be used without restrictions. Examples of typical applications are in building automation and process automation. Wireless communication is only possible in this class.

### CC-B:

In addition to the functions of CC-A, the scope of functions of CC-B supports easy and user-friendly device replacement without the need for an engineering tool. Examples of typical applications are in automation systems with a higher-level machine controller that place relatively low demands for a deterministic data cycle.

### CC-C:

In addition to the functions of CC-B, the scope of functions of CC-C supports high-precision and deterministic data transmission, including for isochronous applications. An example of a typical application is the field of motion control.



# 3. Basic Application

---

If you are a new user, begin with this chapter, it includes a guided tour that provides a basic overview of installing, configuring and using the I-7580.

In the following examples the S7-1200 PLC from Siemens is used to be a PROFINET IO Controller. The configuration and communication is done by the program “Step 7 V11 SP2 (TIA PORTAL)” provided by Siemens.

## 3.1. Connect to Network, PC and PROFINET IO controller

The I-7580 module is equipped with two RJ-45 Ethernet ports for connection to an Ethernet switch, PC and PROFINET IO controller.

### Tips & Warnings

---



1. When users connect I-7580 and switch, users should not connect LAN1 and LAN2 to switch at the same time, else it will lead to abnormal network.
2. When users connect network devices by daisy chain topology, users can connect these devices in series by LAN1 and LAN2.

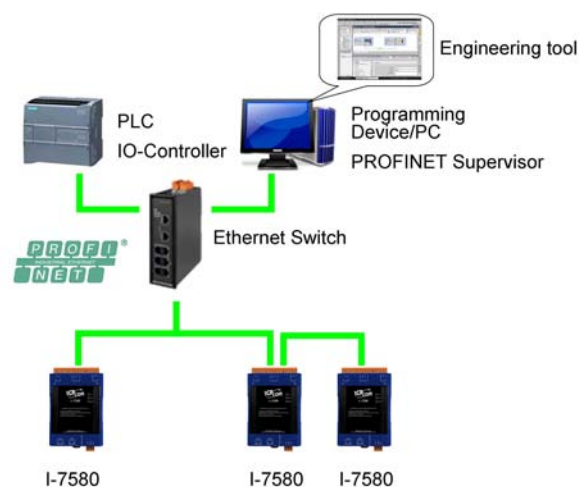

## 3.2. Network configuration

In this example, please follow the below configuration to configure the network.

PC:

IP: 192.168.6.210

Mask: 255.255.0.0

PLC:

Device name: plc1

IP: 192.168.6.211

Mask: 255.255.0.0

I-7580:

Device name: i-7580

IP: 192.168.6.212

Mask: 255.255.0.0

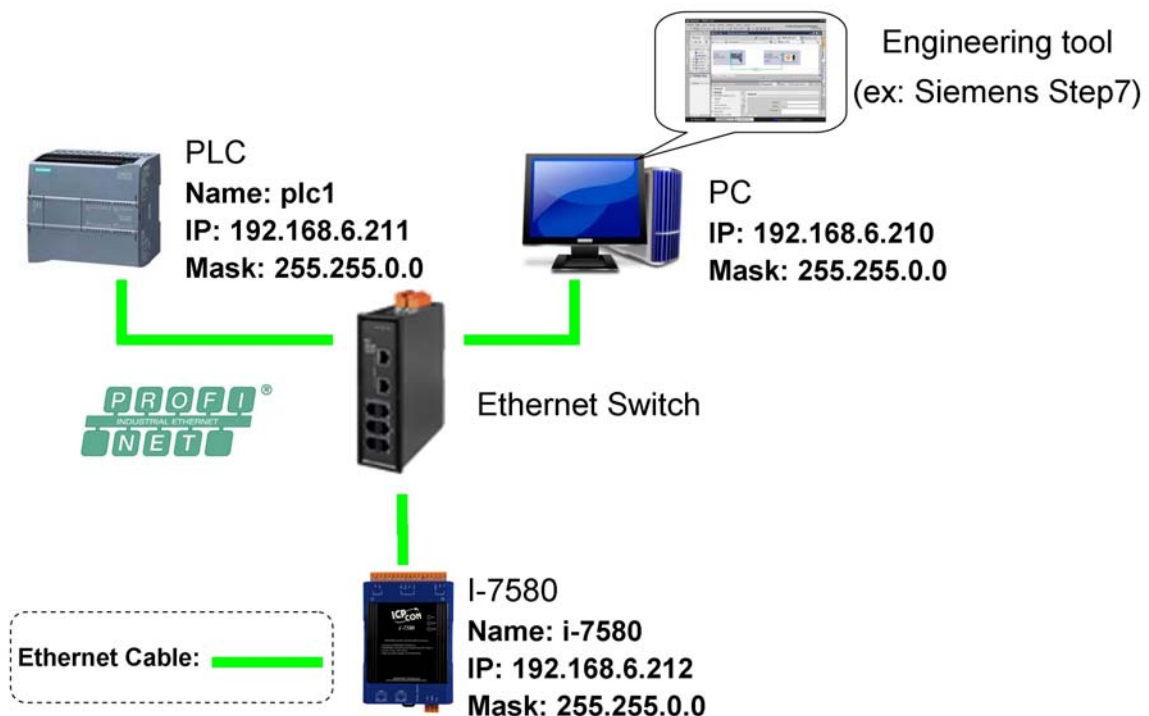

I-7580 User Manual (Version 1.00, May/2014)



## Step 1: Set PC's IP

- ◆ Click “start->Settings->Network Connections”

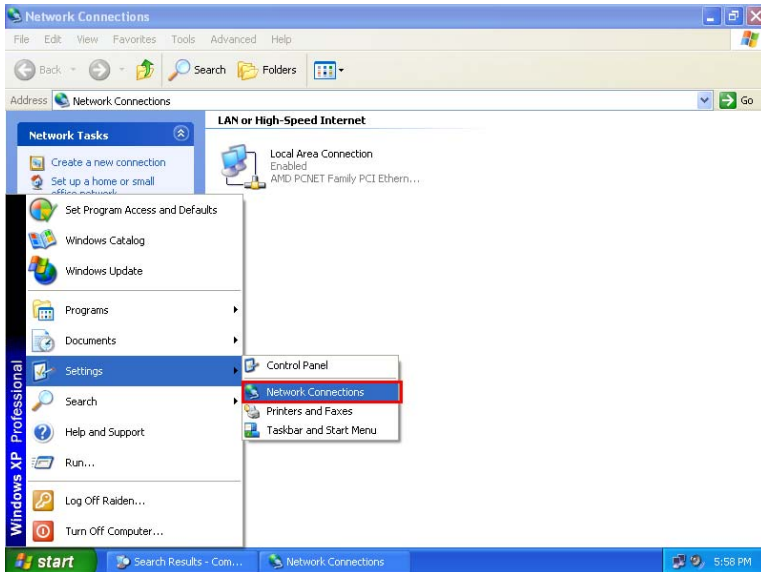

- ◆ Double click “Local Area Connection” icon



- ◆ Click “Properties” button

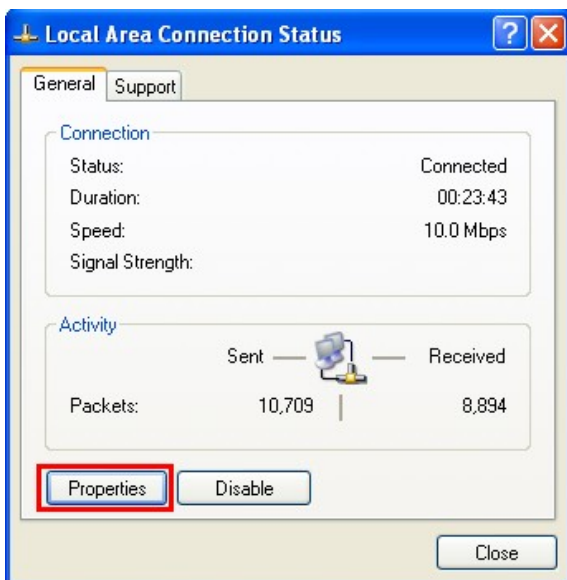

- ◆ Select “Internet Protocol(TCP/IP)” and click “Properties” button

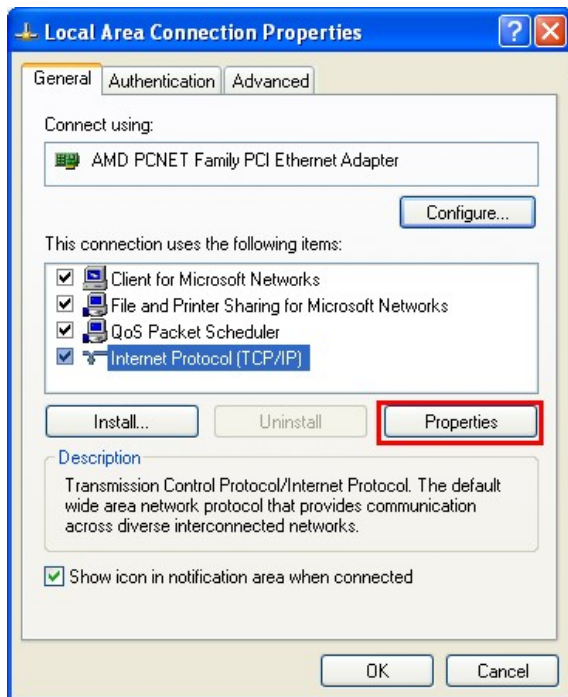

- ◆ Set “Internet Protocol Properties” and then click “OK” button.

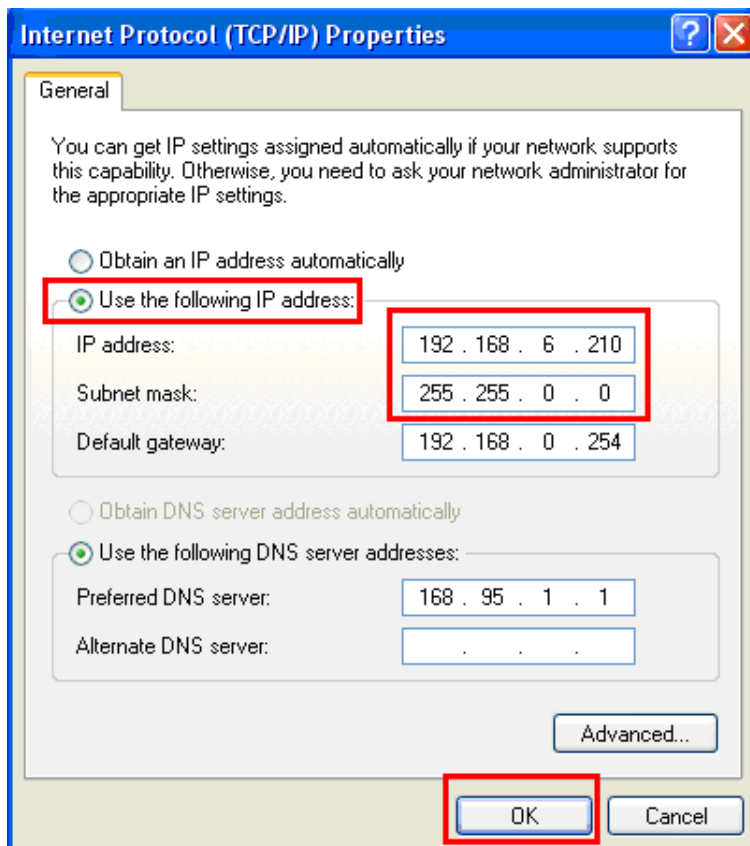

## Step 2: Set PLC's name and IP

- ◆ Double Click TIA icon to start Step 7 V11



- ◆ Click "Project view"

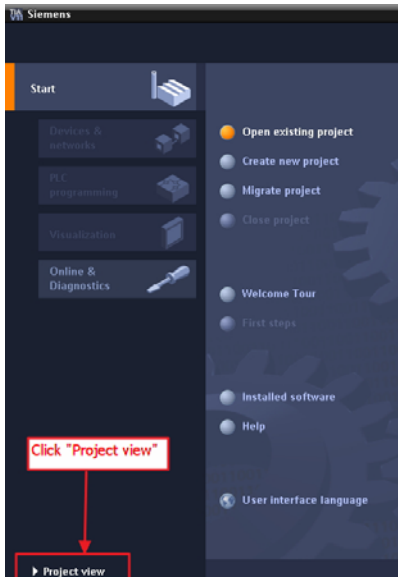

- ◆ Search accessible devices

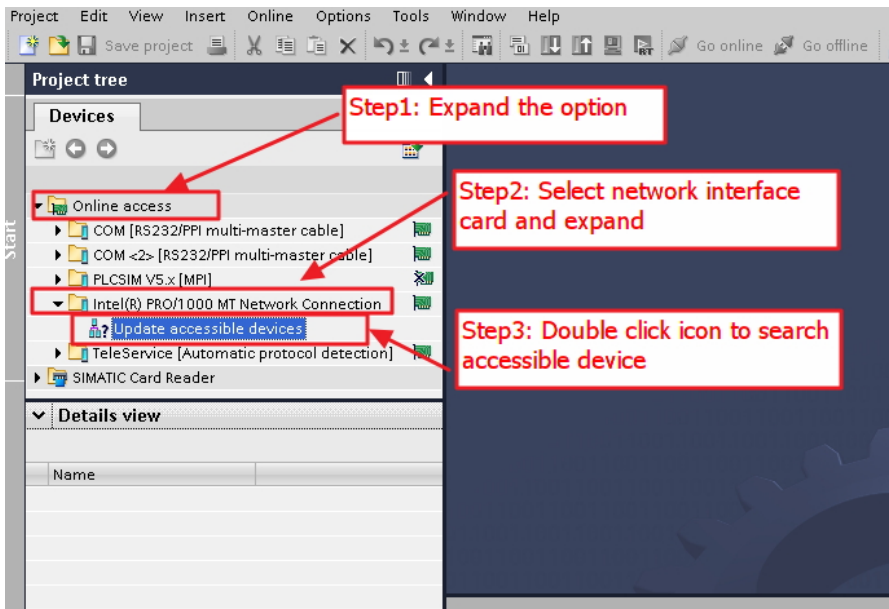

- ◆ Select PLC and click “Online & diagnostics” button

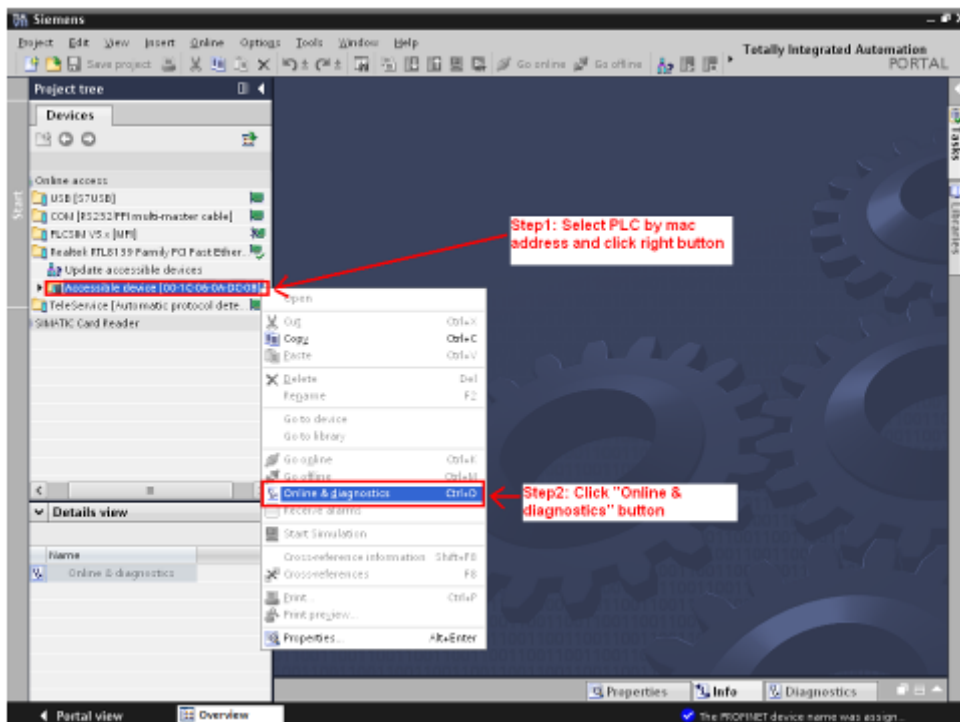

- ◆ Set IP and Mask

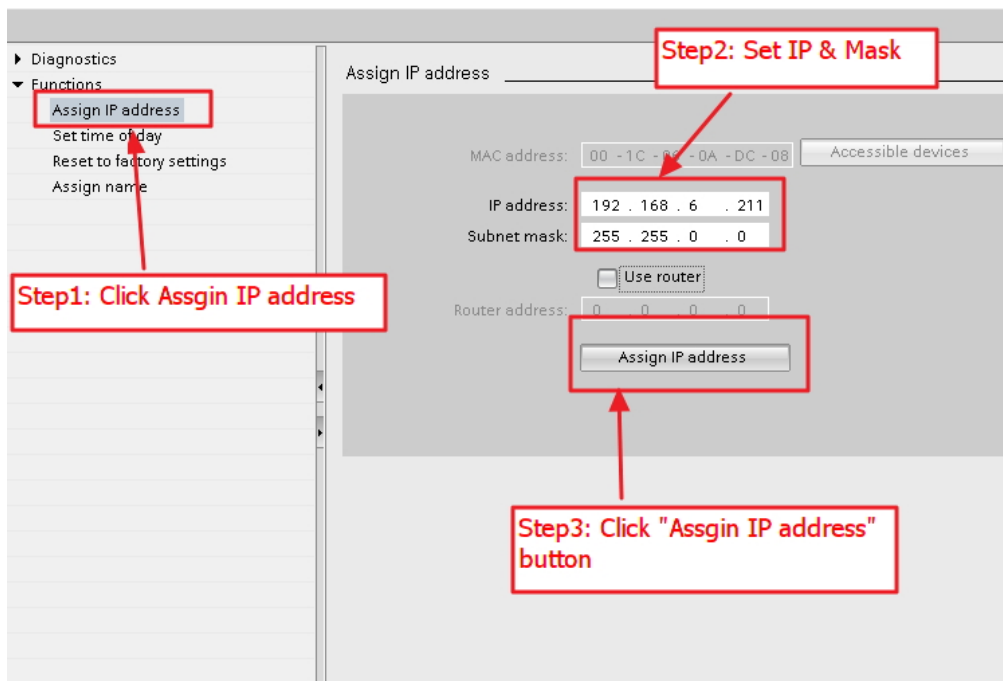

◆ Set device name

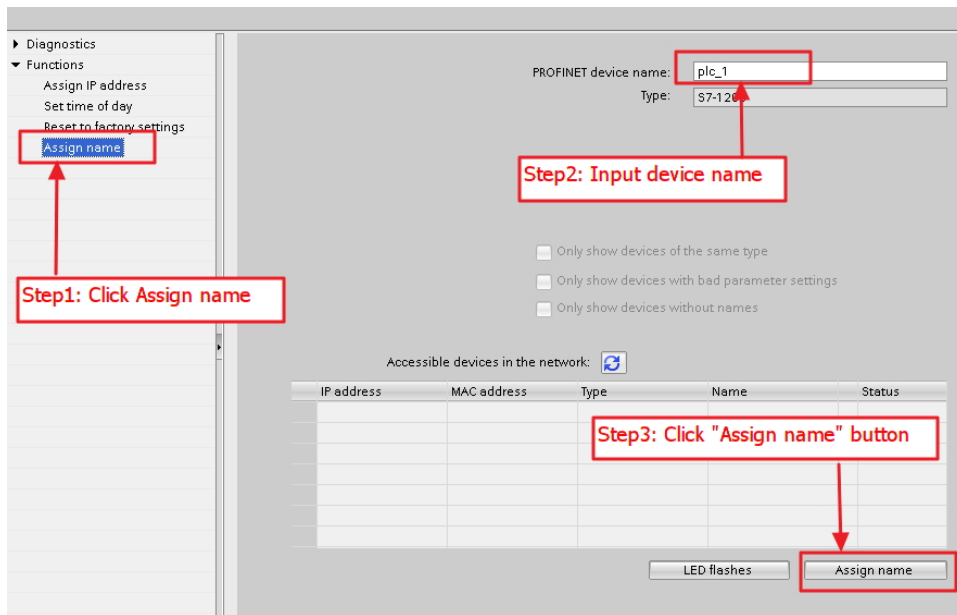

**Step 3: Set I-7580 module's name and IP**

◆ Search accessible devices

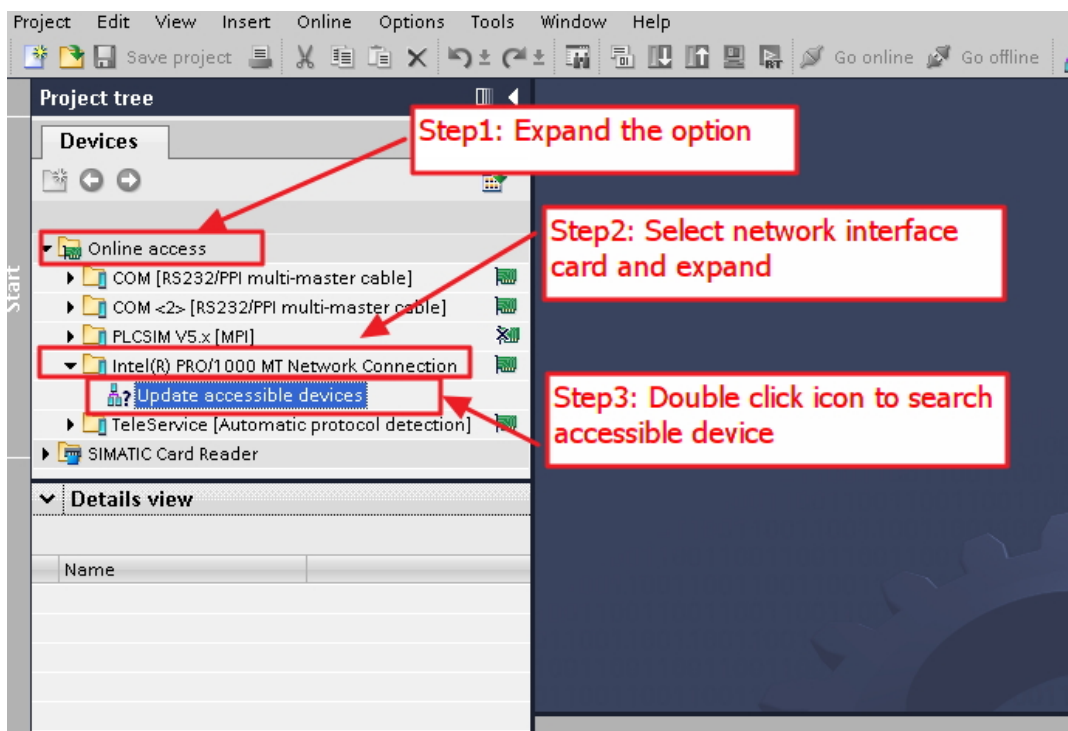

- ◆ Select I-7580 module and click “Online & diagnostics” button

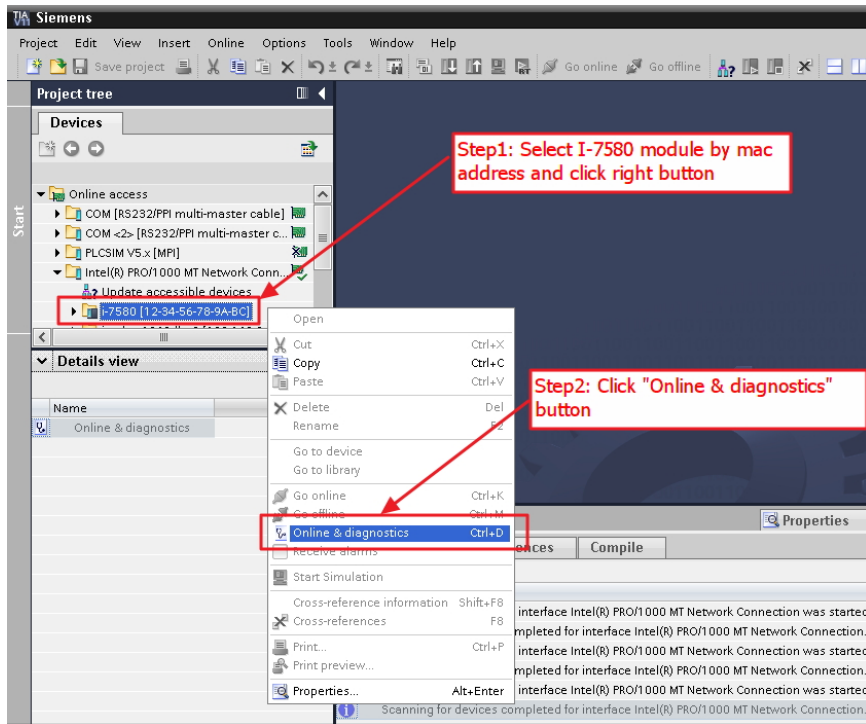

- ◆ Set IP and Mask

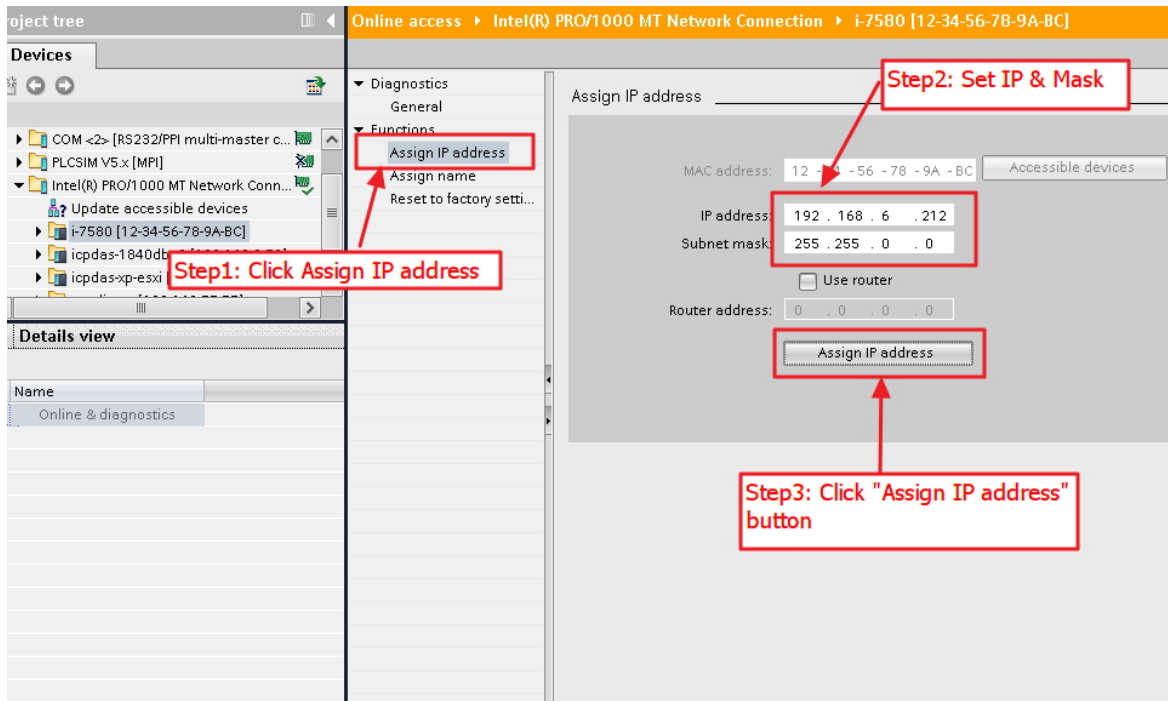

## ◆ Set device name

Online access > Intel(R) PRO/1000 MT Network Connection > i-7580 [12-34-56-78-9A-BC]

▼ Diagnostics  
General

▼ Functions  
Assign IP address  
**Assign name**  
Reset to factory settings

PROFINET device name:   
Type:

**Step2: Input device name**

Only show devices of the same type  
 Only show devices with bad parameter settings  
 Only show devices without names

Accessible devices in the network:

| IP address | MAC address | Type | Name | Status |
|------------|-------------|------|------|--------|
|            |             |      |      |        |
|            |             |      |      |        |
|            |             |      |      |        |
|            |             |      |      |        |
|            |             |      |      |        |

**Step1: Click Assign name**

**Step3: Click "Assign name" button**

### 3.3. GSD Import

In this example, please follow the step to import GSD file.

#### Step 1: Get GSD file

The GSD file can be obtained from companion CD or our FTP site:

CD: \fieldbus\_cd\profinet\converter\i-7580\gsd\

[ftp://ftp.icpdas.com/pub/cd/fieldbus\\_cd/profinet/converter/i-7580/gsd/](ftp://ftp.icpdas.com/pub/cd/fieldbus_cd/profinet/converter/i-7580/gsd/)

#### Step 2: Import GSD file

- ◆ Double Click TIA icon to start Step 7 V11



- ◆ Click "Project view"

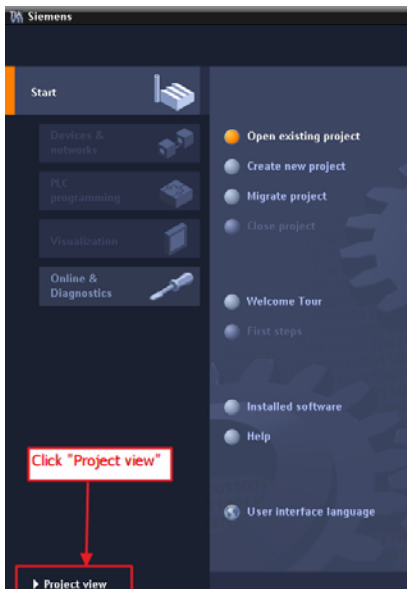



◆ Select “Menu->Options->Install general station description file (GSD)”

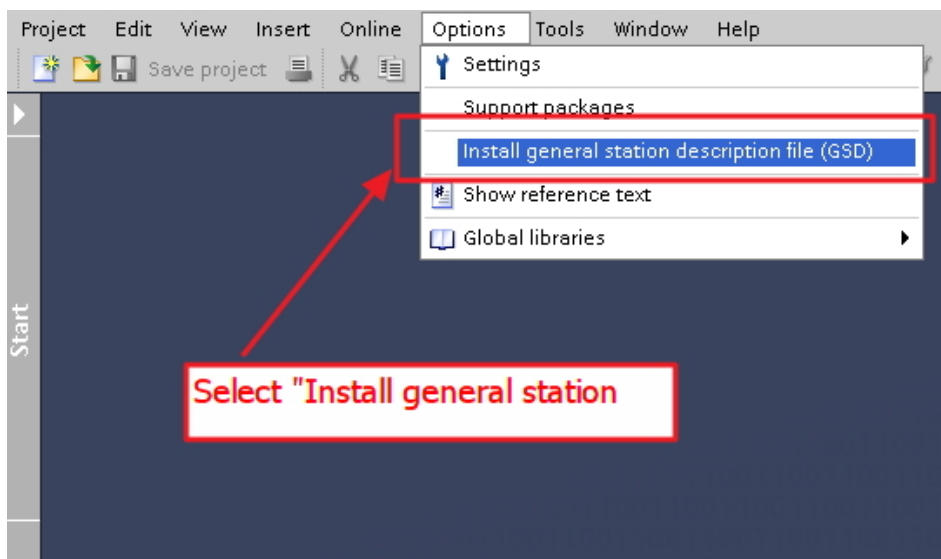

◆ Select and install GSD file

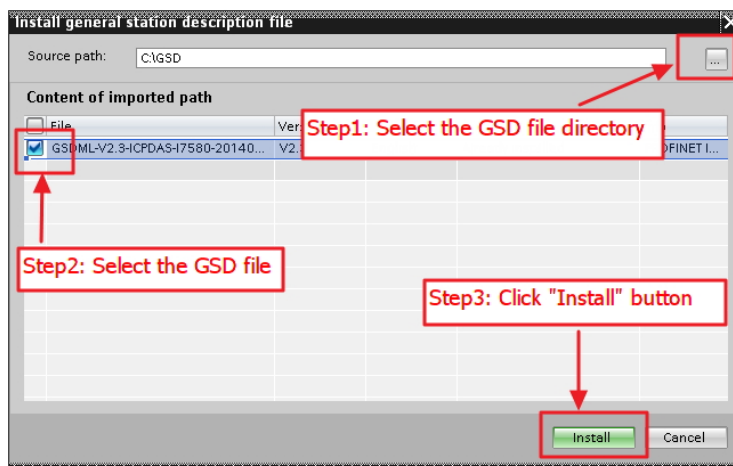

## 3.4. Project Setup

In this example, please follow the step to setup project.

### Step 1: Create the project

- ◆ Double Click TIA icon to start Step 7 V11



- ◆ Create the Project

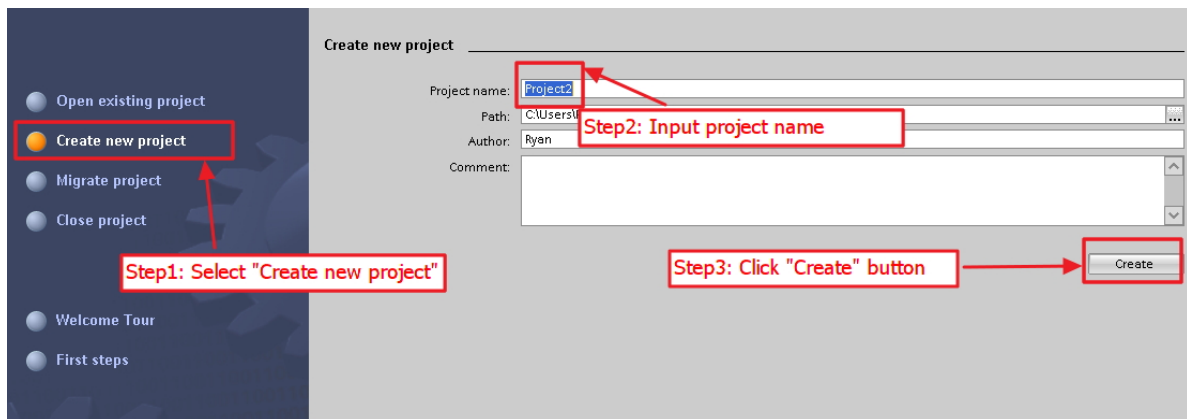

## Step 2: Project configuration

### ◆ Add a PLC device

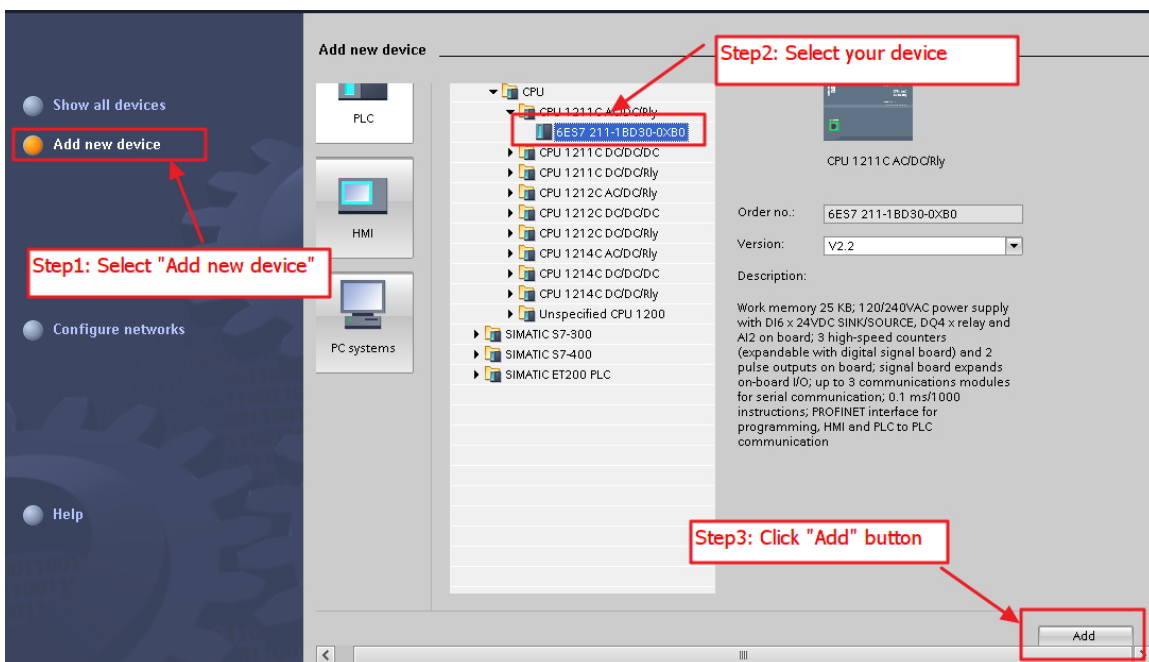
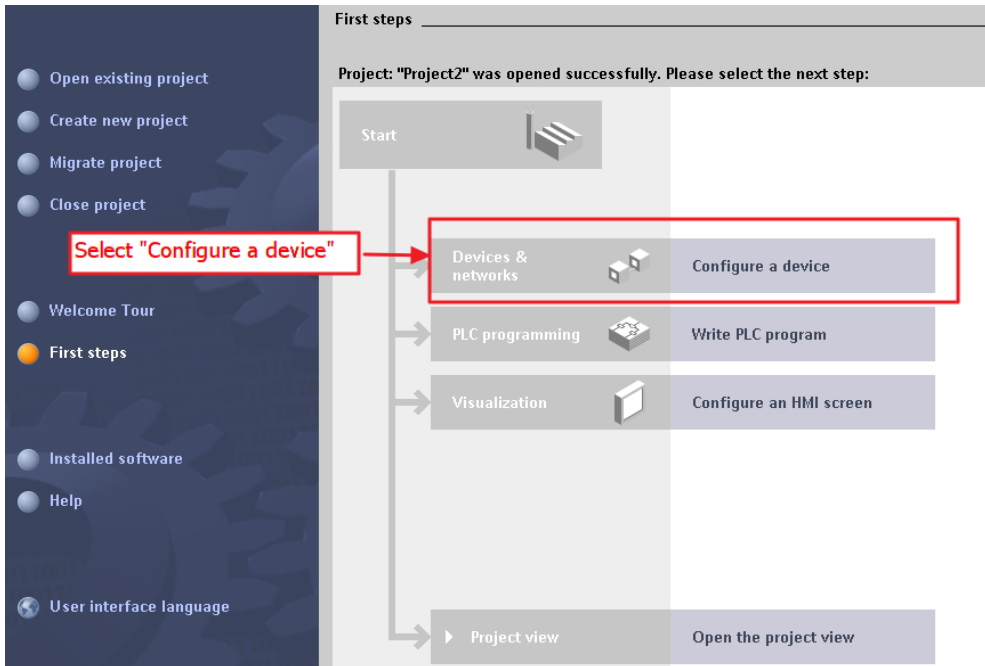

◆ Set the device name of PLC to “PLC\_1”

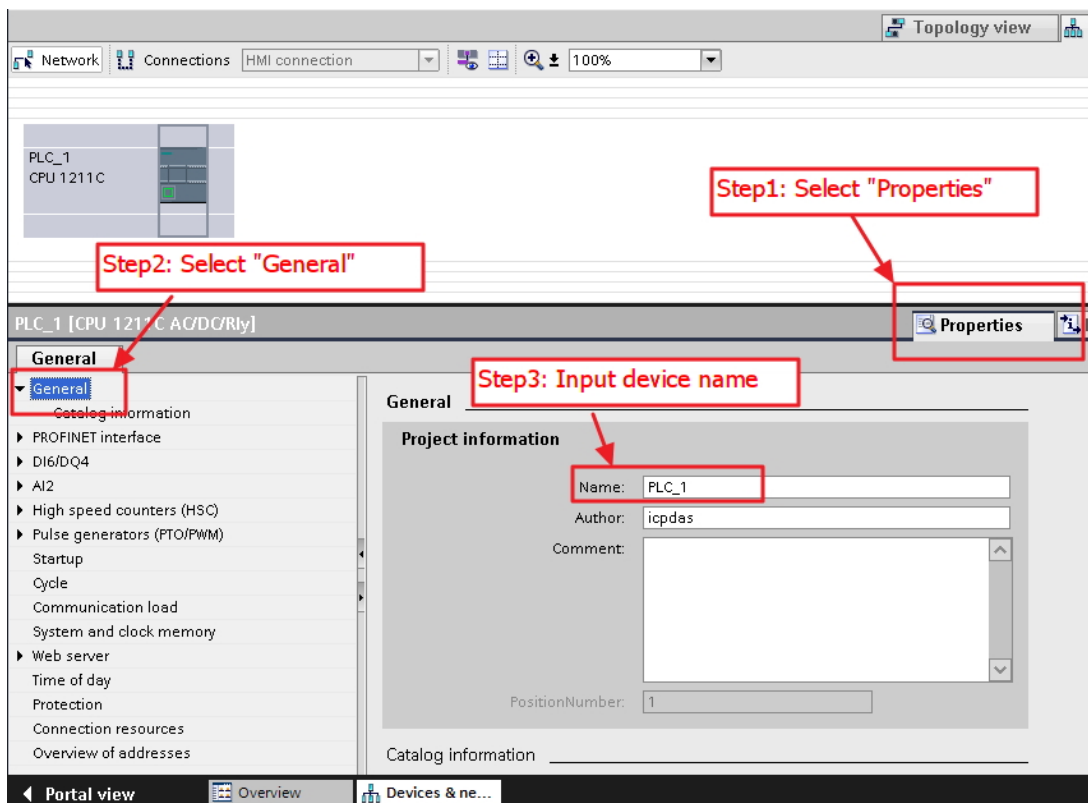

◆ Set the IP and mask of PLC and add a new subnet

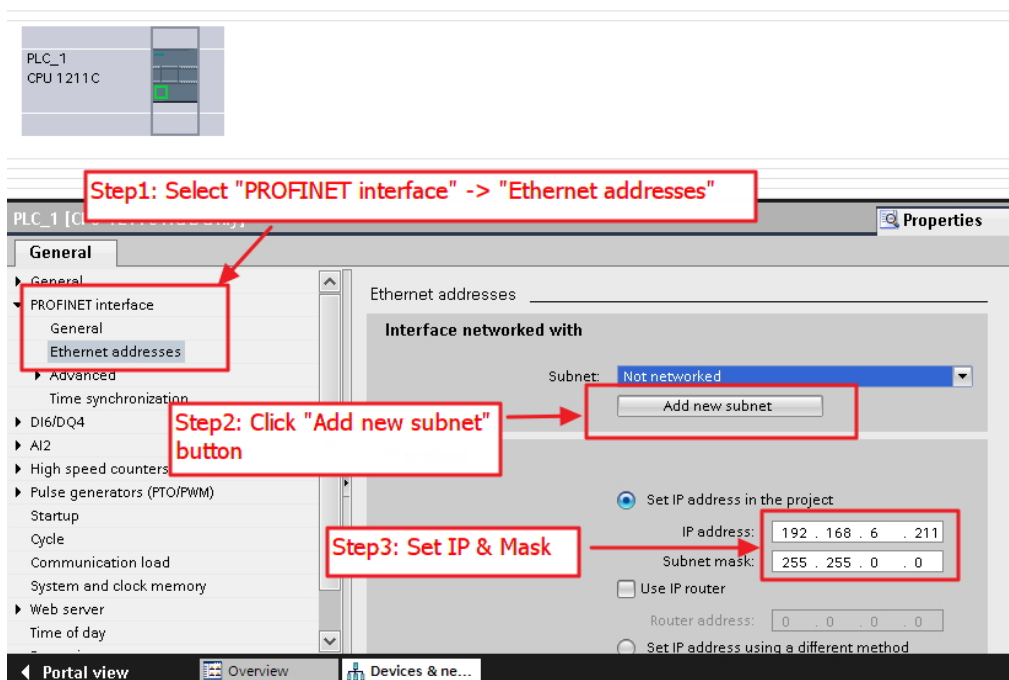

◆ Add I-7580 module

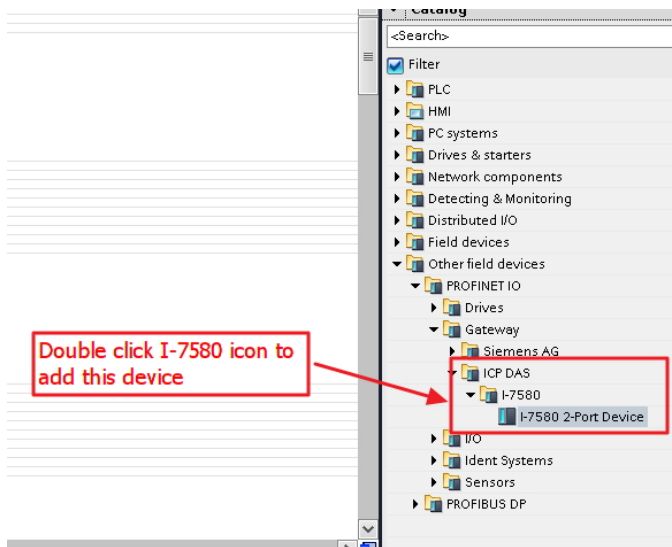

◆ Select PROFINET interface

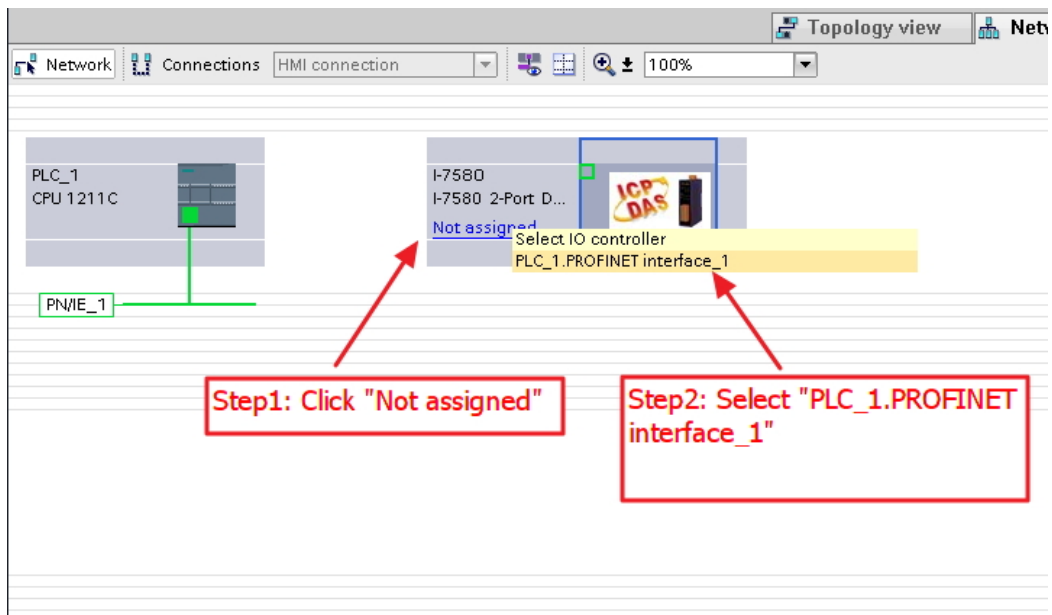

◆ Set device name to "i-7580"

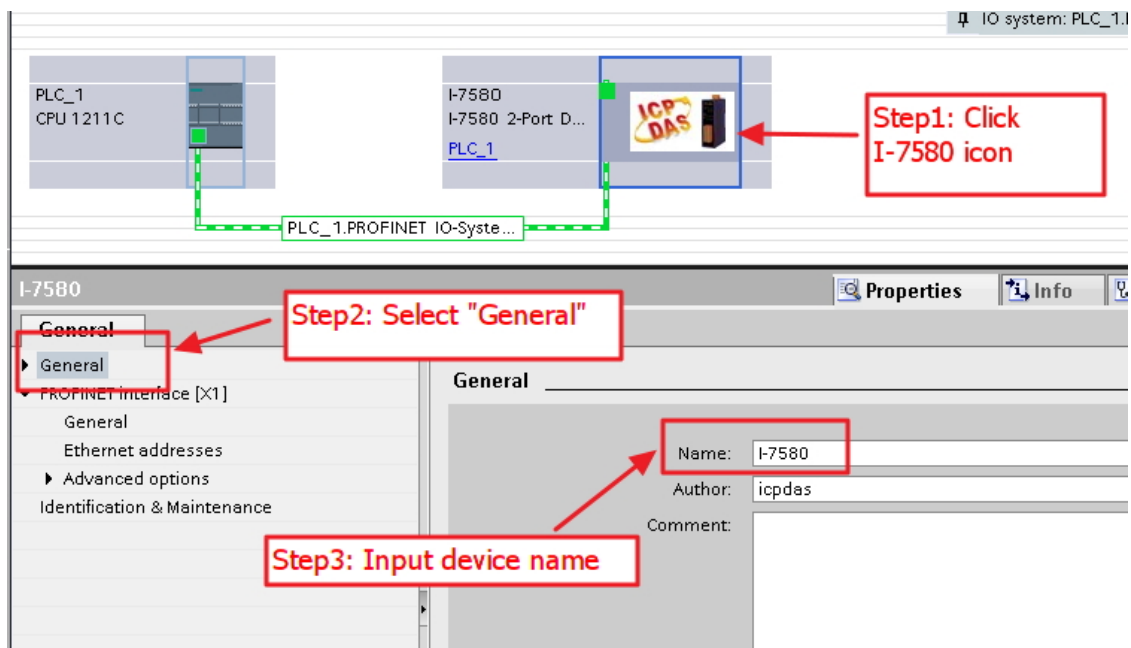

◆ Set the IP of I-7580 module

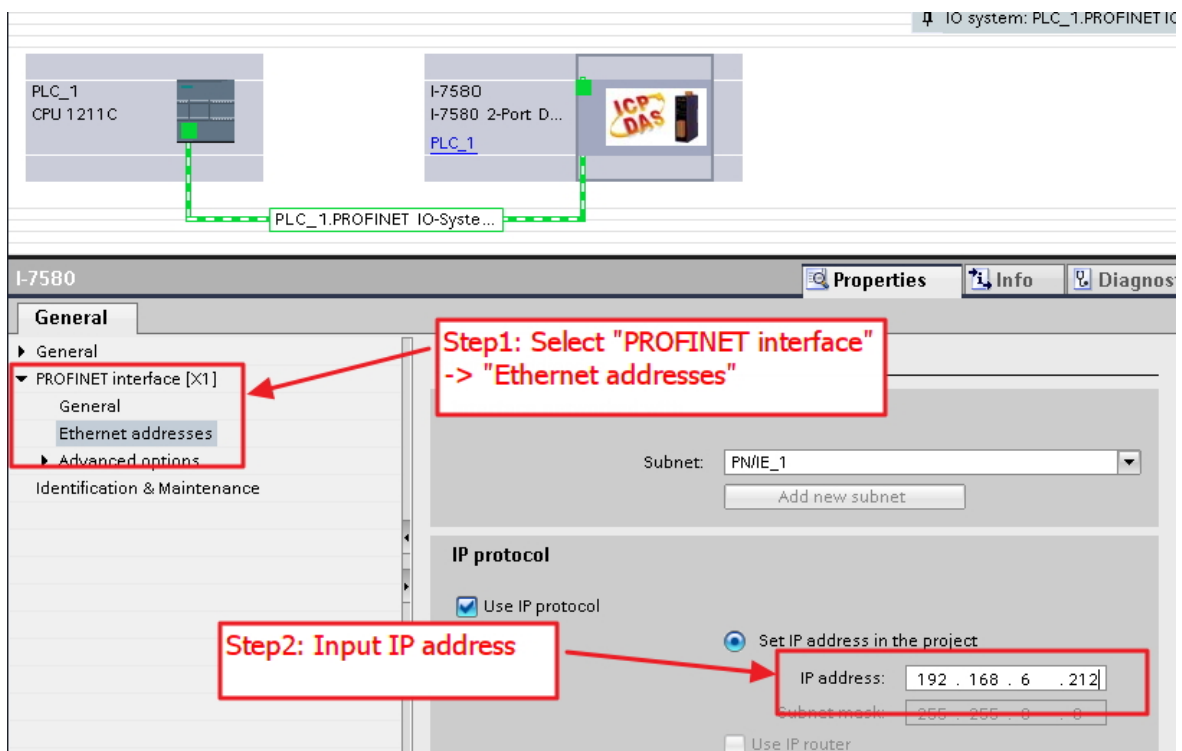

◆ Select module type of I-7580 module

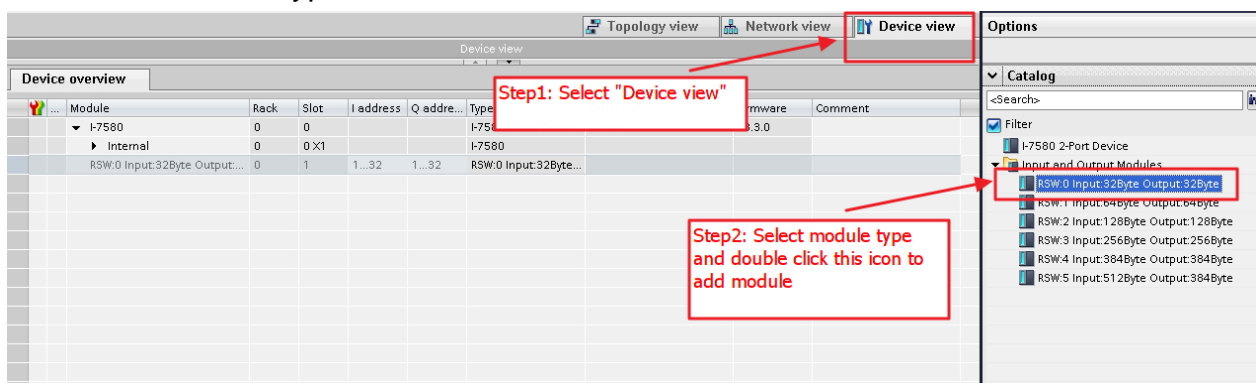

◆ Set module parameters of I-7580 module

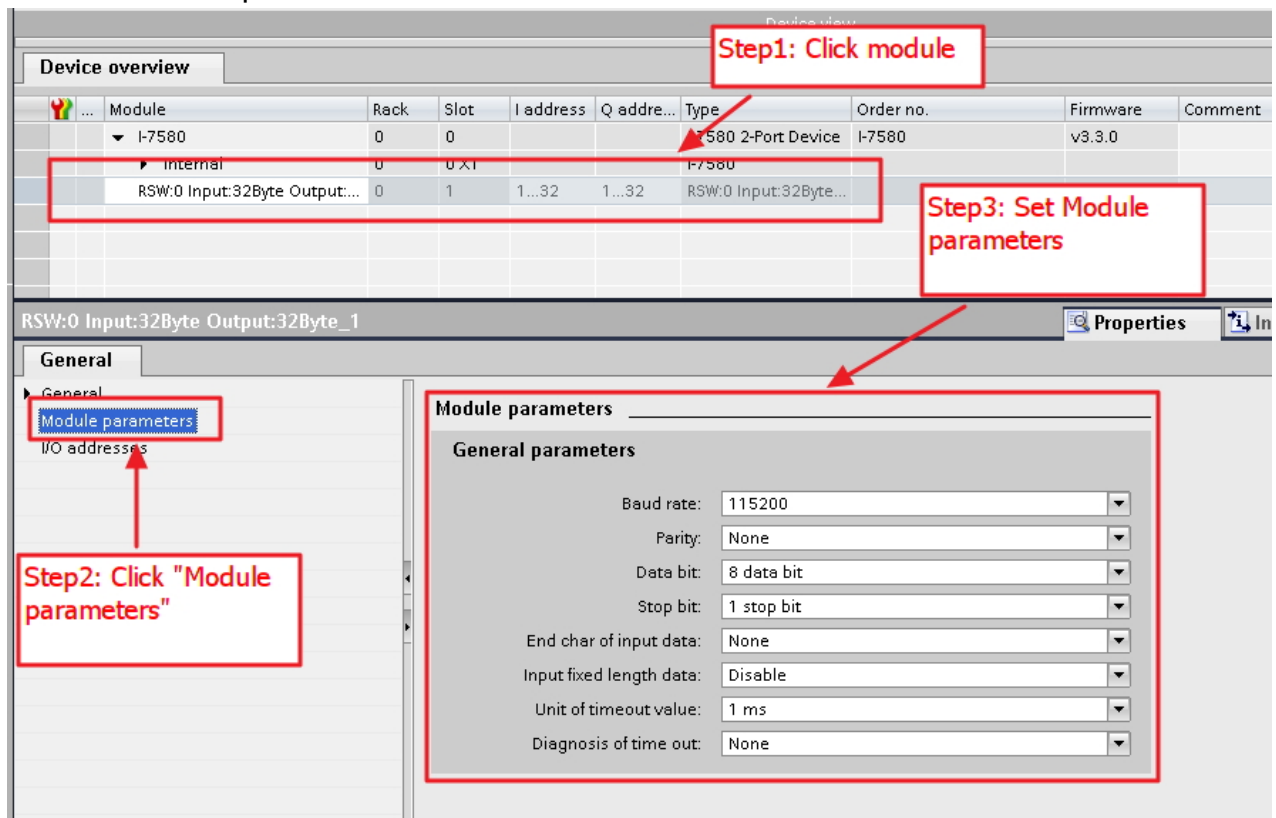

## ◆ Compile and download to device

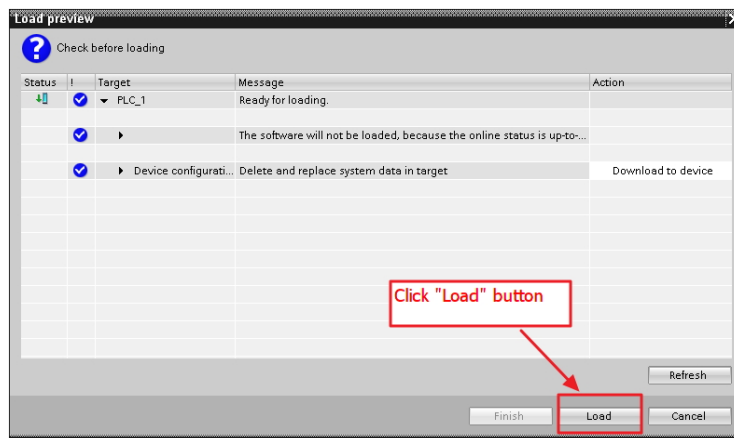
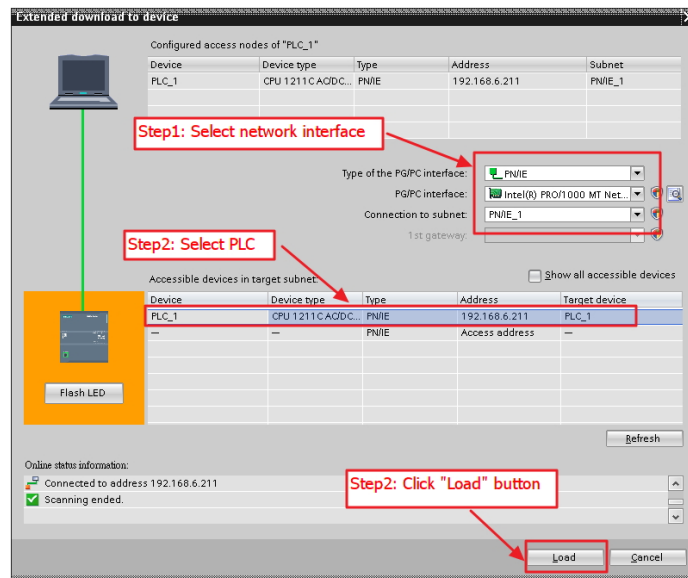
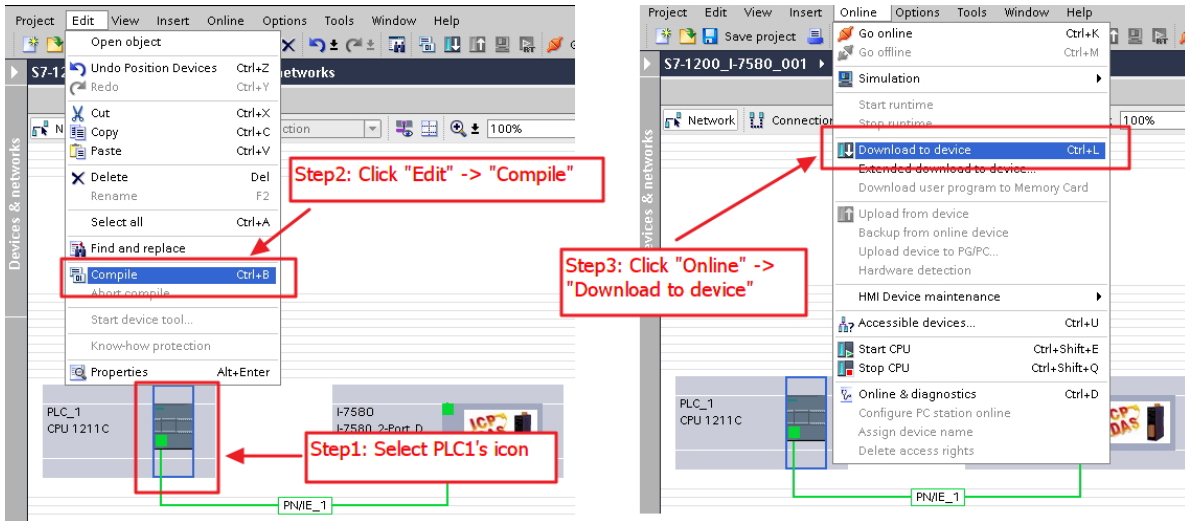



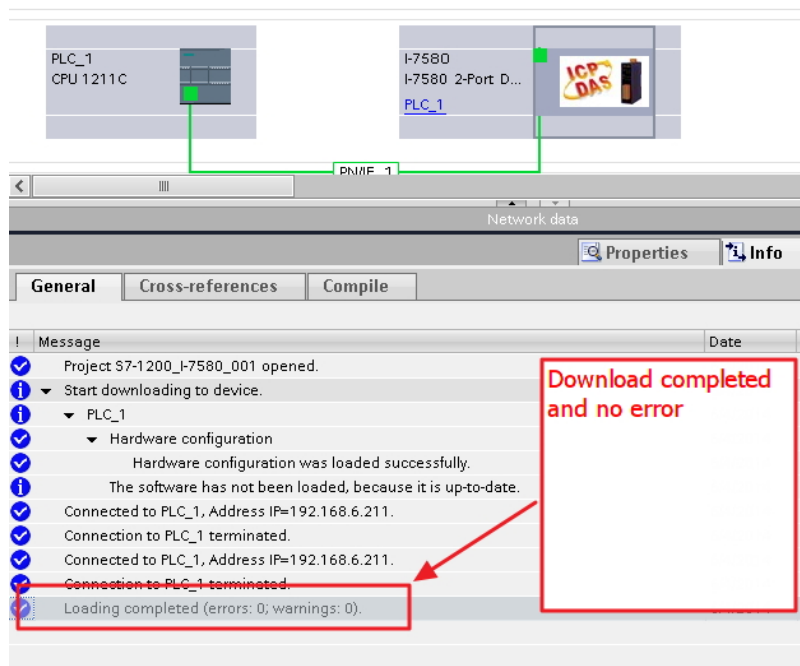
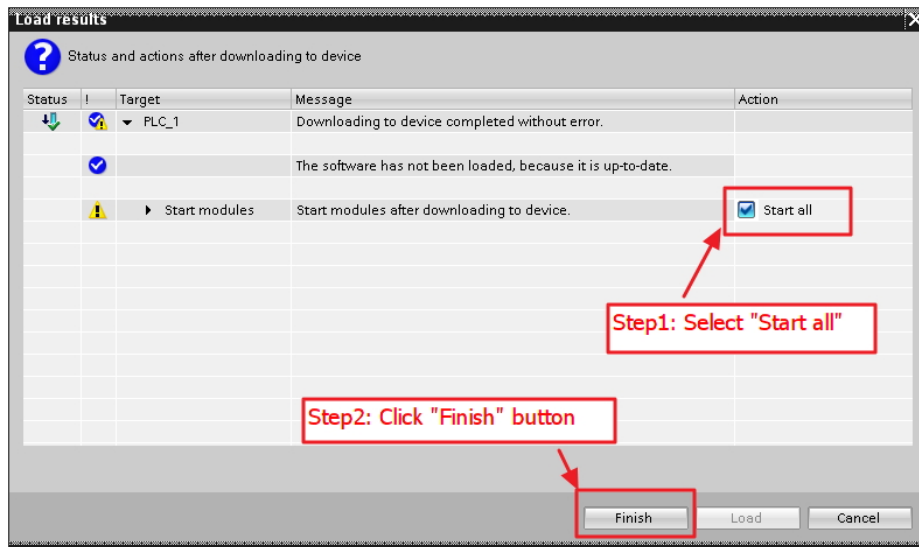

At this time, the AP LED should turn on, BOOT LED and ERR LED should turn off, it means the connection between PLC and I-7580 module is established.

# 4. Communication

---

## 4.1. Communication Sequence

I-7580 module has basically got 4 buffers:

- PROFINET IO device input buffer
- PROFINET IO device output buffer
- COM port input buffer
- COM port output buffer

PROFINET IO controller has basically got 2 buffers:

- PROFINET IO controller input buffer
- PROFINET IO controller output buffer

In I-7580, data is transferred from the COM port input buffer to PROFINET IO device output buffer and from PROFINET IO device input buffer to COM port output buffer. The data flow in I-7580 is shown in below.

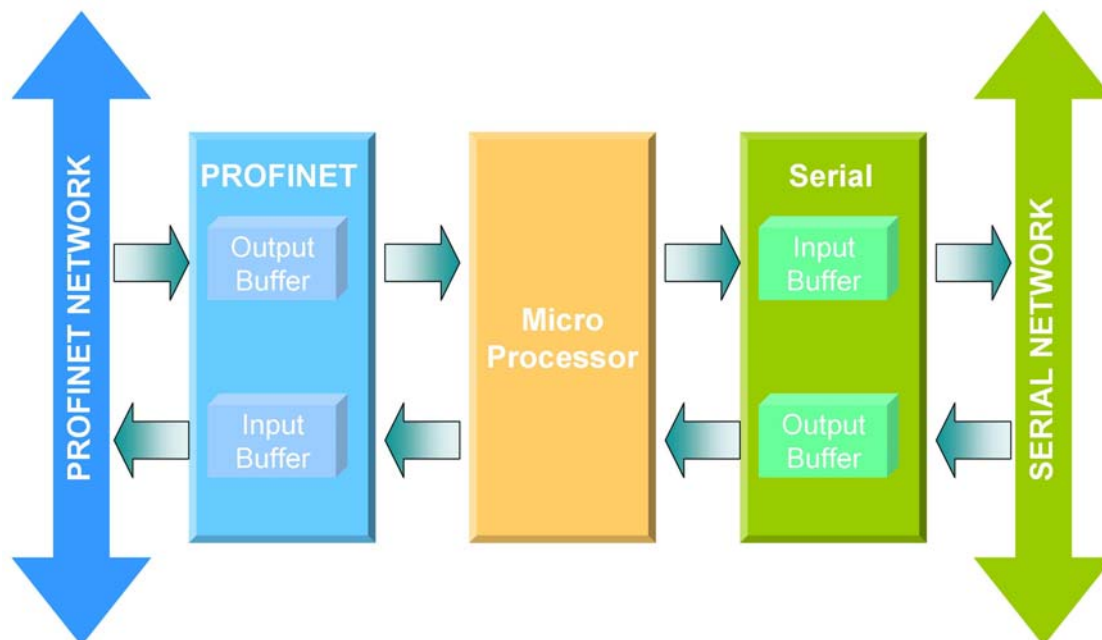

During each message cycle PROFINET IO controller writes the content of its output buffer to PROFINET IO device input buffer and reads the content of PROFINET IO device output buffer to its input buffer. The exchange cycle is taking place even

I-7580 User Manual (Version 1.00, May/2014)

though the content of the PROFINET IO controller and PROFINET IO device output buffer has not changed. The data flow between PROFINET IO controller and I-7580 is shown in below.

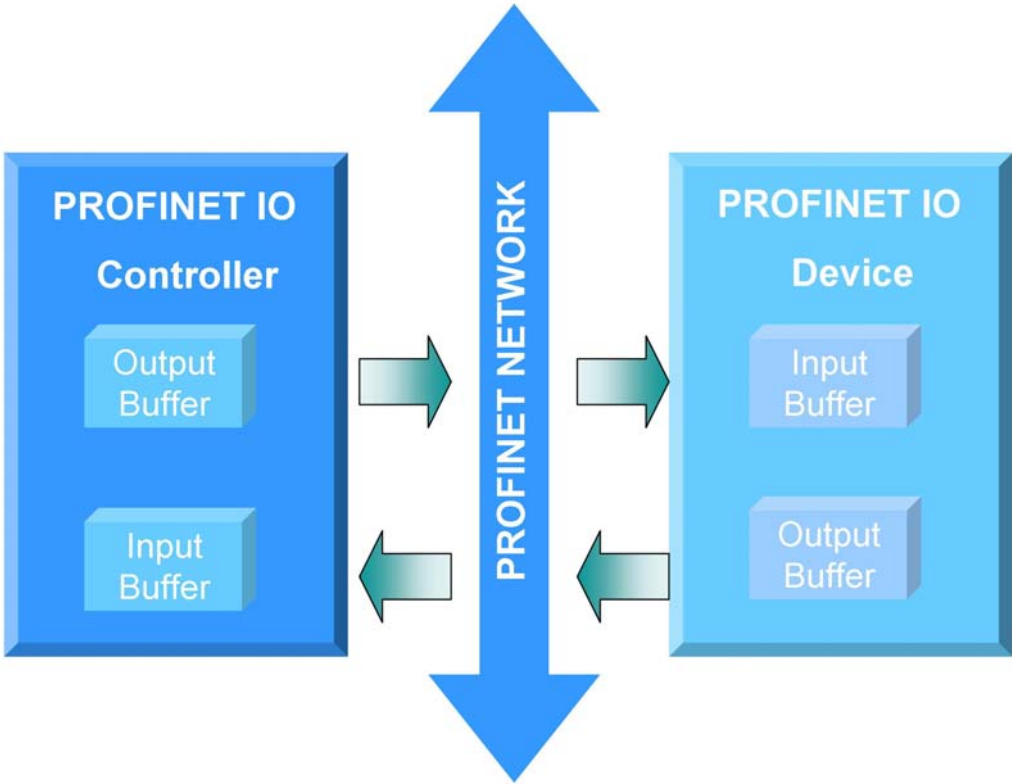

## 4.2. Module configuration

The user can set the size of the I/O modules in the PROFINET configuration tool. Each I/O module will allocate input 8 bytes and output 8 bytes for system. The settings of the modules are described below.

- Max. I/O modules: 1
- "RSW:0 Input:32Byte Output:32Byte" module
- "RSW:1 Input:64Byte Output:64Byte" module
- "RSW:2 Input:128Byte Output:128Byte" module
- "RSW:3 Input:256Byte Output:256Byte" module
- "RSW:4 Input:384Byte Output:384Byte" module
- "RSW:5 Input:512Byte Output:384Byte" module

### Tips & Warnings

---



If AP LED turn on, BOOT LED turn off and ERR LED flash slow. It means that the value of rotary switch does not match the settings of the modules(please refer to section 1.5. Overview -> Rotary Switch).

---

## 4.3. Module Parameter Settings

The user can configure the module parameters to set the communication mode and data format by the PROFINET configuration tool. The module parameters are described below.

- COM port baud rate : 1200 / 2400 / 4800 / 9600 / 19200 / 38400 / 57600 / 115200 / 230400 / 460800
- COM port parity : None / Even / Odd
- COM port data length : 7 / 8
- COM port stop bit : 1 / 2
- End char of input data : None / CR / LF / CR+LF / LF+CR
- Input fixed length data: Enable / Disable
- Unit of timeout value: 1 ms / 10 ms
- Diagnosis of time out: None / Master Slave mode / Cyclic input data mode

### ► Diagnosis of time out about input data

---

#### 1. Master Slave mode:

In this mode, the I-7580 acts as a local serial master, sends a request to the slaves of the serial network and expects an immediate response.

If the time between the request send and the response received exceeds 3 seconds, the I-7580 will send the diagnostic message “Input Data Error –Data loss”.

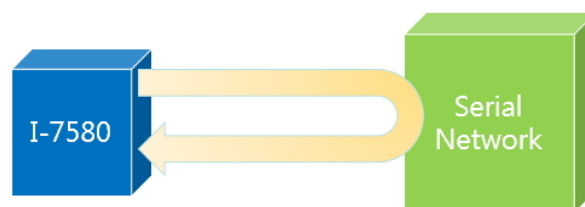

#### 2. Cyclic input data mode:

In this mode, the I-7580 is continuously receiving telegrams from the serial network without sending any request telegrams.

If the time interval between two arriving telegrams is greater than 3 seconds, the I-7580 will send the diagnostic message “Input Data Error –Data loss”.

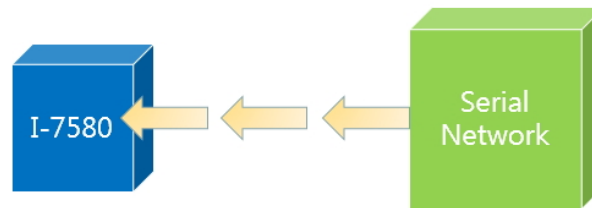

## 4.4. PROFINET Input Data Area

The maximum input data length of I-7580 is 512 bytes. The first 8 bytes of the received input data are reserved for the communication status. The remaining data in the input data area represents the data packet received from the serial network. The 9th byte therefore shows the first byte of the received serial data.

| Byte    | Data        | Description                                                                                                                                      |
|---------|-------------|--------------------------------------------------------------------------------------------------------------------------------------------------|
| 0       | 0x00        | I-7580 is currently not transmitting I/O data                                                                                                    |
|         | 0x01        | I-7580 is transmitting data to the COM port                                                                                                      |
|         | 0x02        | I-7580 is receiving data from the COM port                                                                                                       |
| 1       | Error State | Bit 0: Output FIFO overflow<br>Bit 1 : Input FIFO overflow<br>Bit 2 : Output Data loss<br>Bit 3 : Input Data loss<br>Bit 4 : Input Data overflow |
| 2       | Length      | Received data length (High byte)                                                                                                                 |
| 3       |             | Received data length (Low byte)                                                                                                                  |
| 4       | Input       | Received data count (High byte)                                                                                                                  |
| 5       | Count       | Received data count (Low byte)                                                                                                                   |
| 6       | Output      | Transmitted data count (High byte)                                                                                                               |
| 7       | Count       | Transmitted data count (Low byte)                                                                                                                |
| 8 ~ 511 | Data        | Receive data from COM port                                                                                                                       |

I-7580 module built-in three modes to identify data from two batches of data packet. They are (1) Interval time, (2) Fixed data length, and (3) End character of data.

### ► Interval time mode

If the time between two consecutive bytes exceeds the timeout value, the module transfers the data from the COM port input buffer to the PROFINET IO device output buffer. The default timeout value is set to the duration needed to send one data byte. That means if after a time period of one byte no additional data arrives then the data already in the COM port input buffer will be regarded as a data packet.

It is recommended that the interval time between every message arriving at the

COM port should be greater than 2 milliseconds.

### ➤ Fixed data length mode

---

The converter counts the number of bytes arriving at the COM port. If the specified number of data length has entered the serial input buffer the content is removed from the input buffer and transferred to the PROFINET IO device output buffer. The last string will only be send after a transmit time of three bytes has elapsed.

To use this feature, “Input fixed length data” of module parameter has to be set “Enable” (please refer to section 4.3. Module Parameter Settings).

The data length has to be defined in the byte 5,6 of the PROFINET output data area (please refer to section 4.5. PROFINET Output Data Area).

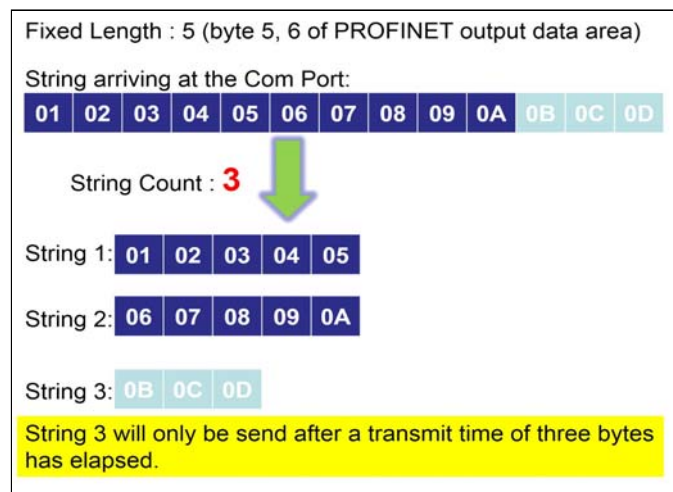

### ➤ End character mode

---

As soon as the converter detects the end characters of the incoming serial data stream, it removes the data from the serial receive buffer and transfers it to the PROFINET IO device output buffer of the converter.

If the time interval between two consecutive bytes is longer than the time needed to transmit three bytes then the module treat this situation as an end of a string.

To use this feature, “End char of input data” of module parameter has not to be set “None” (please refer to section 4.3. Module Parameter Settings).



Example 1:

The end character : CR(0x0D)

String arriving at the Com Port:



String Count : 3



String 1: 01 02

String 2: 03

String 3: 04 05 06 07

Example 2:

The end character : CR(0x0D)

Time interval between two consecutive bytes is longer than the time needed to transmit three bytes

String arriving at the Com Port:



String Count : 3



String 1: 01 02

String 2: 03 04

String 3: 05 06 07 08

## 4.5. PROFINET Output Data Area

The maximum output data length of I-7580 is 384 bytes. The first 8 bytes are needed to set the communication behavior of the converter.

| Byte  | Data    | Description                                       |
|-------|---------|---------------------------------------------------|
| 1     | 0 ~ 255 | Data output command                               |
| 2     | 0x01    | Control bit – clear all diagnostic messages       |
|       | 0x02    | Control bit – clear Received data count           |
|       | 0x04    | Control bit – clear Transmitted data count        |
| 3     | Length  | Output data length (High byte)                    |
| 4     |         | Output data length (Low byte)                     |
| 5     | Length  | Fixed data length (High byte)                     |
| 6     |         | Fixed data length (Low byte)                      |
| 7     | 0~255   | Interval time between the two batches of the data |
| 8     | 0~255   | Timeout value                                     |
| 9~384 | Data    | Output data to COM port                           |

### ► Data output command (byte 1)

The PROFINET IO Controller is cyclically polling the I-7580 module. PROFINET IO Controller sends data from its output buffer to the input buffer of the converter. If no new data is put on the PROFINET IO Controller output buffer, the PROFINET IO Controller sends in each polling cycle the same data. It is therefore necessary for the converter to detect whether the data arriving at its PROFINET IO device input buffer has already been sent before or is new. The converter recognizes a new data packet when the value of the first byte differs from the previous data packet. A change of the first byte results in an immediate output of the newly arrived data (at the PROFINET IO device input buffer) to the serial COM port.

When the user wants to send a new data packet to the converter, the user should increase progressively the first byte (ex: 0->1, 1->2, 2->3, ..., 255->0) and the converter will send the new data packet to the serial COM port. If the user changes the first byte but doesn't increase progressively it (ex: 0->2, 1->3, 2->5), the converter will send a diagnostic message "Output data - data loss". The user can know the PROFINET data may be loss by this message.

## Tips & Warnings

---



The converter will send no data to the connected serial devices if the content of the first byte of two consecutive PROFINET messages is identical. Even if the remaining bytes differ, no message will be forwarded to the COM port. The converter detects a new data packet only by checking the first byte.

---

### ► Control bit (byte 2)

---

Bit 0: When this bit is set, diagnostic messages send by the I-7580 module will all be cleared.

Bit 1: When this bit is set, the I-7580 module sets the “Received data count” (please refer to section 4.4. PROFINET Input Data Area) to zero.

Bit 2: When this bit is set, the I-7580 module sets the “Transmitted data count” (please refer to section 4.4. PROFINET Input Data Area) to zero.

Bit 3~7: The remaining bits have to be set to zero.

### ► Output data length (byte 3, byte 4)

---

The output data length default value is zero. It has to be set for every single output command otherwise no data will be send to the COM port.

These 2 bytes determines the number of bytes copied from the I-7580 PROFINET IO device input buffer to the COM output buffer. That means independent of the data length send by the master only the number of bytes specified in the third byte will be forwarded to the COM port.

### ► Fixed data length (byte 5, byte 6)

---

These 2 bytes determines the length of the serial response data string. The converter waits until the data arriving at the COM port buffer has reached the specified length.

To use this feature, “Input fixed length data” of module parameter has to be set “Enable” (please refer to section 4.3. Module Parameter Settings).

## ► Interval time (byte 7)

These 2 bytes can increase the interval time between the two batches of the data packet, it means the converter can delay the data output from PROFINET to Series COM port.

Example: Interval time: 15 ms

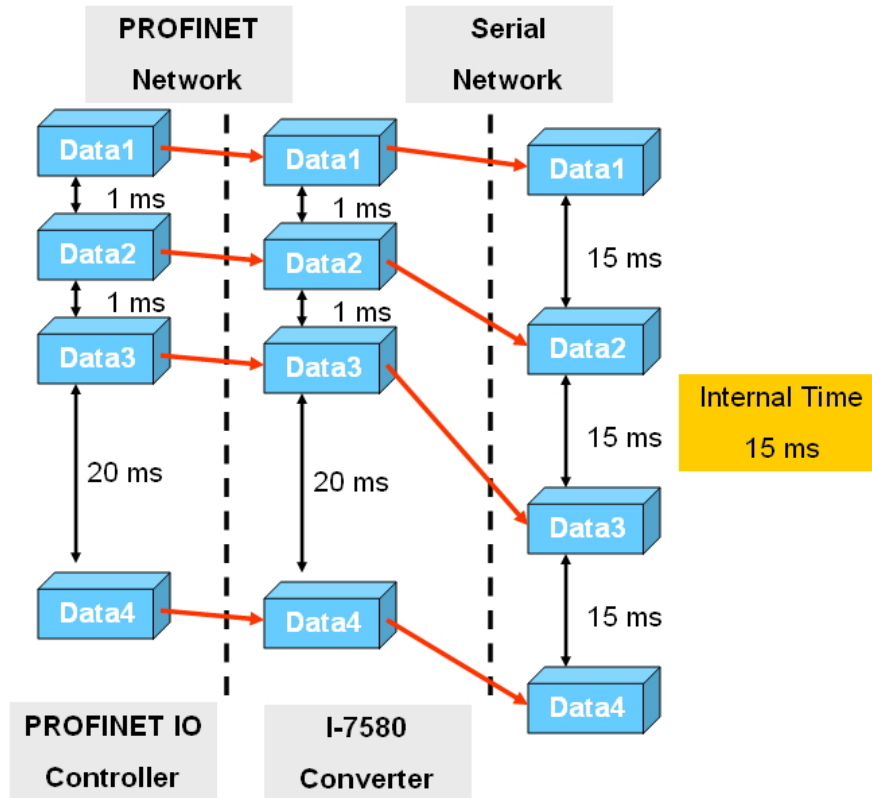

## ► Timeout value (byte 8)

The timeout is only relevant for the communication between the I-7580 converter and the serial network. The converter receives the response of a device in the serial network at the COM port as a continuous data stream. A silent interval in the data stream exceeding the timeout value signals the converter the end of the message and forwards this message to its PROFINET IO device output buffer.

Valid values for the timeout: 0 to 255

A "0" represents the minimum value which equals the transmission time of one byte  $[(\text{start bit} + \text{data bit} + \text{parity bit} + \text{stop bit}) / \text{Baudrate}]$ .

A "1" assigns a timeout value of either 1 or 10 milliseconds depending on the chosen unit (1 or 10ms). The maximum value "255" represents either 255 milliseconds (time unit: 1ms) or 2550 milliseconds (time unit: 10ms).

This byte specifies the timeout for the data stream of the serial response. If for

every request send by the converter multiply responses are expected, then the timeout applies to all these messages.

## 4.6. Diagnostic Messages

The I-7580 module has two types of diagnostic message. They are “Output Data Error” and “Input Data Error”.

| Type              | Description   |
|-------------------|---------------|
| Output Data Error | FIFO overflow |
|                   | Data loss     |
| Input Data Error  | FIFO overflow |
|                   | Data loss     |
|                   | Data overflow |

### ► Output Data Error

---

1. When the speed of PROFINET network is bigger than serial network and the PROFINET IO controller transmit continuously data to the I-7580 module, the output buffer of the I-7580 will overflow and I-7580 will send the diagnostic message “Output Data Error – FIFO overflow”.
2. When the I-7580 module receives the data output command (first byte of the output data area, please refer to section 4.5. PROFINET Output Data Area) from PROFINET IO controller and the command is not increase continuously (ex: 0->1, 1->2, ..., 254->255, 255->0), the I-7580 will send the diagnostic message “Output Data Error – Data loss” to PROFINET IO controller.

### ► Input Data Error

---

1. When the speed of serial network is bigger than PROFINET network and the serial device transmit continuously data to the I-7580 module, the input buffer of the I-7580 will overflow and I-7580 will send the diagnostic message “Input Data Error – FIFO overflow”.
2. When the I-7580 module can't receive data in time from COM port, it will send the diagnostic message “Input Data Error – Data loss”, please refer to section 4.4. PROFINET Input Data Area.
3. The maximum input data length of the I-7580's COM port is 506 bytes. When the I-7580's COM port receive data more than 506 bytes, it will send the diagnostic message “Input Data Error – Data overflow”.

I-7580 User Manual (Version 1.00, May/2014)

## 4.7. Communication test - Receive

In PC side, we use "Send232" to test PROFINET communication and serial communication. This utility simulates a serial device and can be obtained from our FTP site ([download Send232](#)). We send the string "sendtoi7580" by Send232 and receive the same string in PROFINET input data area.

The figure illustrates the steps to configure and execute a communication test using Send232. It is divided into three numbered sections:

- Section 1:** Shows the Send232 interface with the "COM status" and "Send string with" sections highlighted in red. A red box contains the text "Set parameters and press 'Open'".
- Section 2:** Shows the Send232 interface with the "Send" button highlighted in red. A red box contains the text "Input data and press 'Send' to send data to PC".
- Section 3:** Shows a data monitor window with the following table:

| i  | Name           | Address | Display format | Monitor value |
|----|----------------|---------|----------------|---------------|
| 1  | "IState"       | %IB1    | DEC_unsigned   | 0             |
| 2  | "error state"  | %IB2    | DEC_unsigned   | 0             |
| 3  | "rcv len"      | %IW3    | DEC_unsigned   | 13            |
| 4  | "rcv cnt"      | %IW5    | DEC_unsigned   | 1             |
| 5  | "out_cnt"      | %IW7    | DEC_unsigned   | 0             |
| 6  | "IN_data_(0)"  | %IB9    | Character      | 's'           |
| 7  | "IN_data_(1)"  | %IB10   | Character      | 'e'           |
| 8  | "IN_data_(2)"  | %IB11   | Character      | 'n'           |
| 9  | "IN_data_(3)"  | %IB12   | Character      | 'd'           |
| 10 | "IN_data_(4)"  | %IB13   | Character      | 't'           |
| 11 | "IN_data_(5)"  | %IB14   | Character      | 'o'           |
| 12 | "IN_data_(6)"  | %IB15   | Character      | 'i'           |
| 13 | "IN_data_(7)"  | %IB16   | Character      | '7'           |
| 14 | "IN_data_(8)"  | %IB17   | Character      | '5'           |
| 15 | "IN_data_(9)"  | %IB18   | Character      | '8'           |
| 16 | "IN_data_(10)" | %IB19   | Character      | '0'           |
| 17 | "IN_data_(11)" | %B20    | Hex            | 16#0D         |
| 18 | "IN_data_(12)" | %B21    | Hex            | 16#0A         |

Red arrows point from the following labels to the corresponding values in the table:

- "Data length" points to the value 13 in the "rcv len" row.
- "Received data count" points to the value 1 in the "rcv cnt" row.
- "Received data" points to the characters 's', 'e', 'n', 'd', 't', 'o', 'i', '7', '5', '8', '0' in the "IN\_data\_(0)" through "IN\_data\_(11)" rows.

## 4.8. Communication test - Transmit

In PROFINET output data area, please set value of byte 4 to 8, and input data string "sendtoPC" to byte 9~13. As soon as byte 1 changes its value from 0 to 1, the data string will be transferred to RS232 device.

The image shows two screenshots related to a communication test. The top screenshot displays a table of output data points in a software interface. The bottom screenshot shows the 'Send232 V. 2.0.1 COM1' application window.

| No. | Name            | Address | Display format | Monitor value | Modify |
|-----|-----------------|---------|----------------|---------------|--------|
| 1   | "output cmd"    | %QB1    | DEC_unsigned   | 1             | 1      |
| 2   | "Control bit"   | %QB2    | Hex            | 16#00         |        |
| 3   | "output len"    | %QW3    | DEC_unsigned   | 8             | 8      |
| 4   | "fix len"       | %QW5    | DEC_unsigned   | 0             |        |
| 5   | "interval time" | %QB7    | DEC_unsigned   | 0             |        |
| 6   | "timeout value" | %QB8    | DEC_unsigned   | 0             |        |
| 7   | "OUT_data_(0)"  | %QB9    | Character      | 's'           | 's'    |
| 8   | "OUT_data_(1)"  | %QB10   | Character      | 'e'           | 'e'    |
| 9   | "OUT_data_(2)"  | %QB11   | Character      | 'n'           | 'n'    |
| 10  | "OUT_data_(3)"  | %QB12   | Character      | 'd'           | 'd'    |
| 11  | "OUT_data_(4)"  | %QB13   | Character      | 't'           | 't'    |
| 12  | "OUT_data_(5)"  | %QB14   | Character      | 'o'           | 'o'    |
| 13  | "OUT_data_(6)"  | %QB15   | Character      | 'p'           | 'p'    |
| 14  | "OUT_data_(7)"  | %QB16   | Character      | 'c'           | 'c'    |

Annotations for the top screenshot:

- Red box: "Data output cmd 0x00 -> 0x01" with an arrow pointing to the 'output cmd' row.
- Red box: "Data length" with an arrow pointing to the 'output len' row.
- Red box: "Input string 'sendtoPC'" with an arrow pointing to the 'OUT\_data\_(0)' through 'OUT\_data\_(7)' rows.

Annotations for the bottom screenshot (Send232 V. 2.0.1 COM1):

- Red box: "Received string from I-7580" with an arrow pointing to the 'Receive' field containing 'sendtoPC'.

Page numbers 1 and 2 are located in yellow boxes at the bottom right of each screenshot.



## 5. MiniOS7 Utility Tool

---

The MiniOS7 Utility is a useful tool that provides a quick and easy way to get Ethernet settings and firmware version of I-7580 module.

### 5.1. Installing the MiniOS7 Utility

#### Step 1: Get the MiniOS7 Utility tool

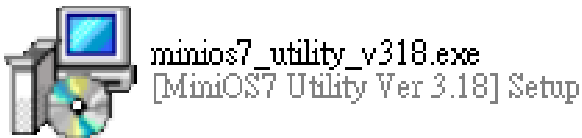

The MiniOS7 Utility can be obtained from companion CD or our FTP site:  
CD:\Napdos\minios7\utility\minios7\_utility\  
[ftp://ftp.icpdas.com/pub/cd/8000cd/napdos/minios7/utility/minios7\\_utility/](ftp://ftp.icpdas.com/pub/cd/8000cd/napdos/minios7/utility/minios7_utility/)

#### Step 2: Follow the prompts to complete the installation

After the installation has been completed, there will be a new short-cut for MiniOS7 Utility on the desktop.

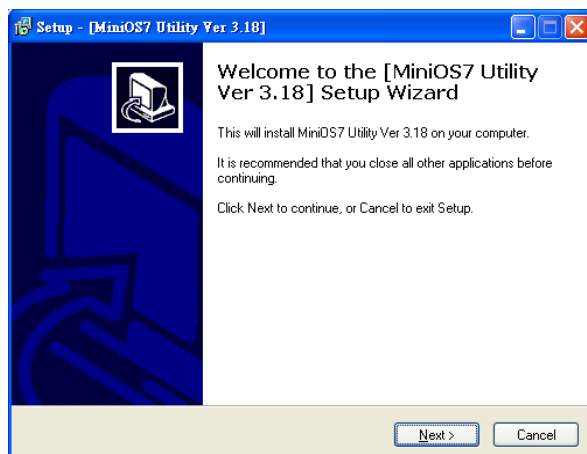

## 5.2. Using MiniOS7 Utility to get Ethernet settings and firmware version

### Step 1: Run the MiniOS7 Utility



Double-click the MiniOS7 Utility shortcut on your desktop.

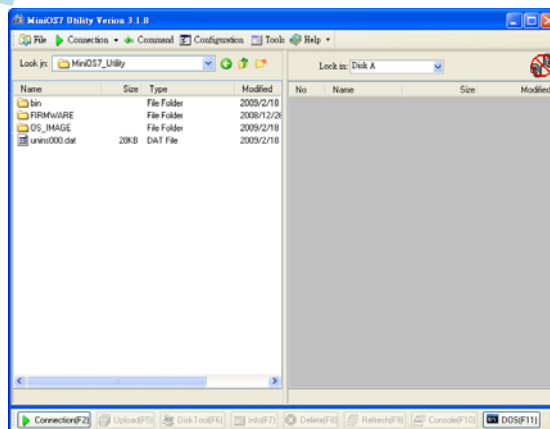

### Step 2: Press "F12" or choose "Search" from the "Connection" menu

After pressing **F12** or choosing **Search** from **Connection** menu, that will search all of the modules that provide by ICP DAS on your network.

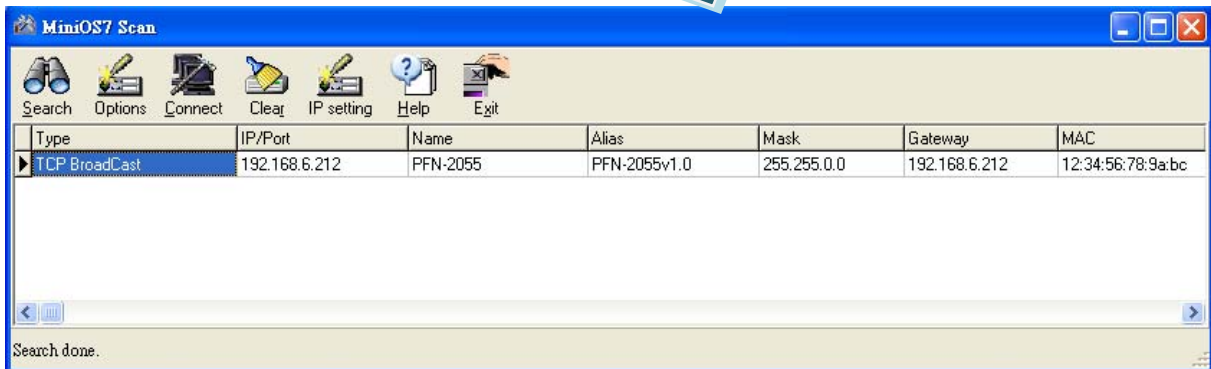
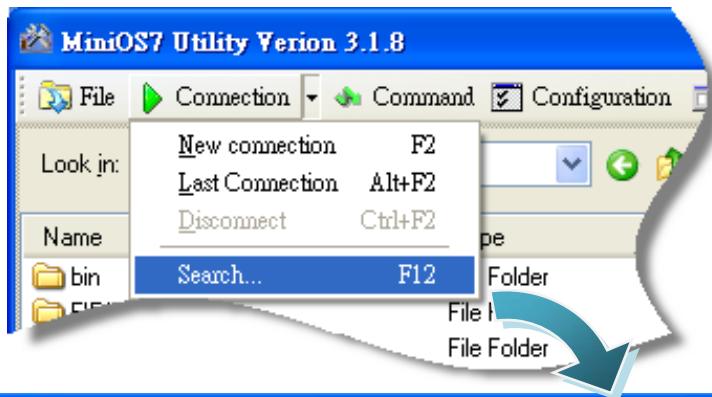

## Tips & Warnings



1. If you can't find the module by searching the network. It means the IP address of I-7580 module is zero (default IP = 0.0.0.0). At this time, please follow the section 3.2. Network configuration=> Step 3: Set I-7580 module's name and IP" to set module's IP and then re-search the network again. Or, wait for the PROFINET controller connect to I-7580 module (AP LED=ON) and then re-search the network again.
2. About scan result of MiniOS7 Utility, Alias=module name & firmware version.

# 6. PFN\_Tool Utility

## 6.1. Installing the PFN\_Tool Utility

### Step 1: Get the PFN\_Tool Utility



The PFN\_Tool Utility can be obtained from companion CD or our FTP site:  
CD:\fieldbus\_cd\profinet\utility\  
[ftp://ftp.icpdas.com.tw/pub/cd/fieldbus\\_cd/profinet/utility/](ftp://ftp.icpdas.com.tw/pub/cd/fieldbus_cd/profinet/utility/)

### Step 2: Follow the prompts to complete the installation

After the installation has been completed, there will be a new shortcut for PFN\_Tool Utility on the desktop.

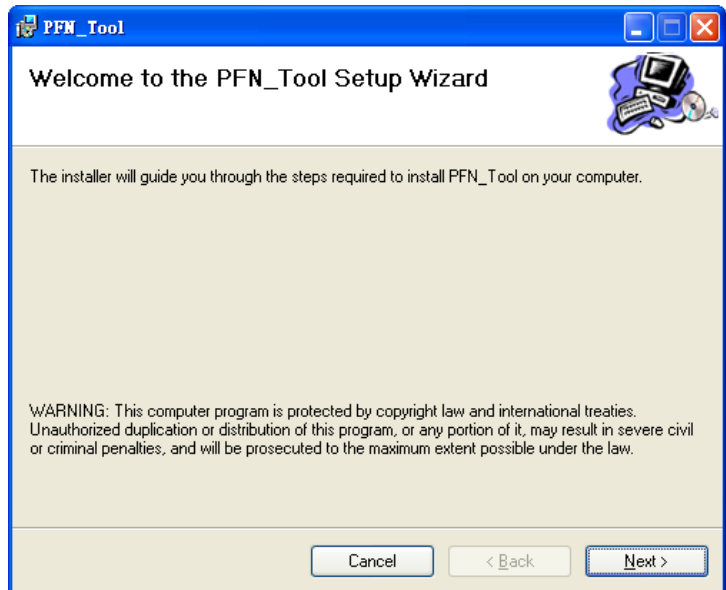

## 6.2. PFN\_Tool Utility Functionalities

### 6.2.1. Module Search

#### Step 1: Select Network Device

Select network device that connect with I-7580 module, and press “Search Start” button.

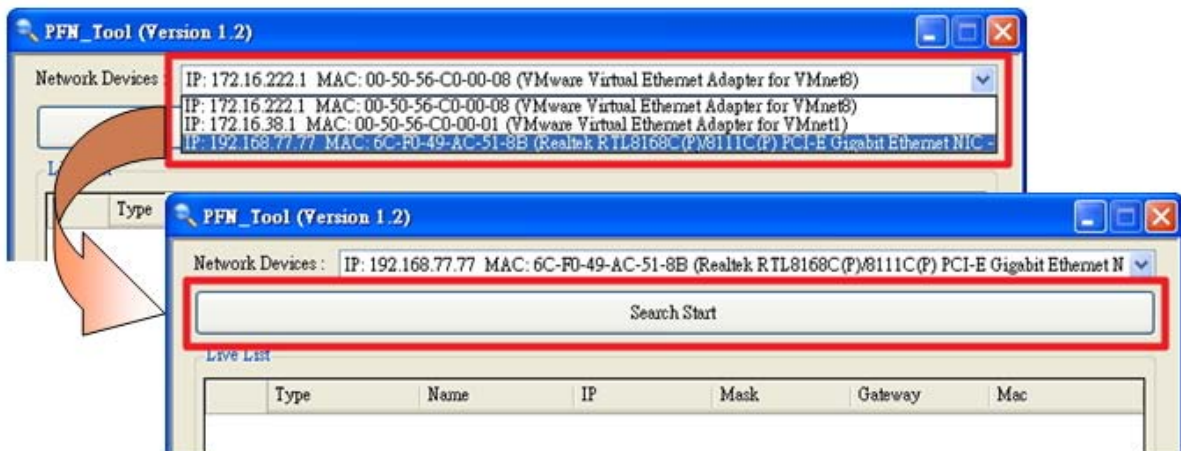

#### Step 2: Search results

Live List will show all of the PROFINET devices on the same network of network device.

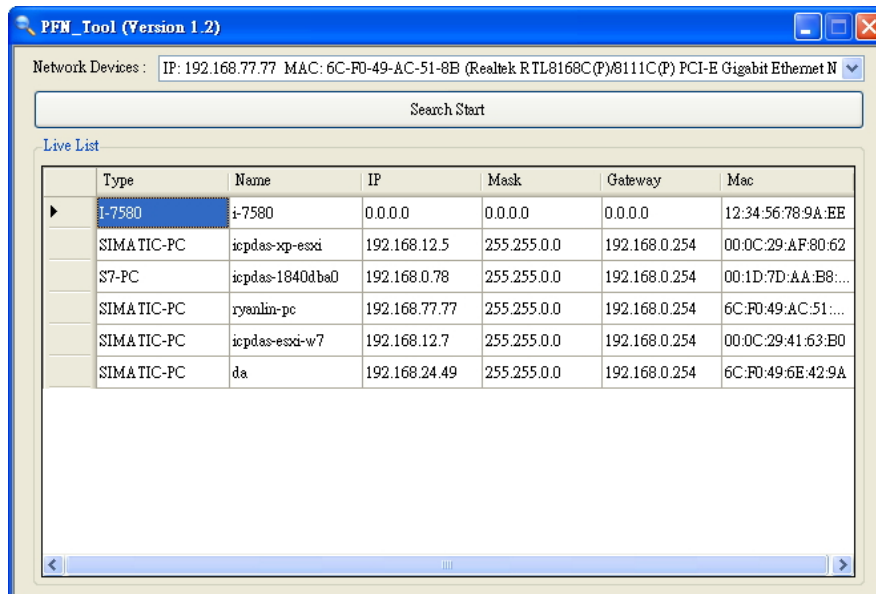

# 6.2.2. Module Basic Configuration

**Step 1: Open Device Basic Configuration**

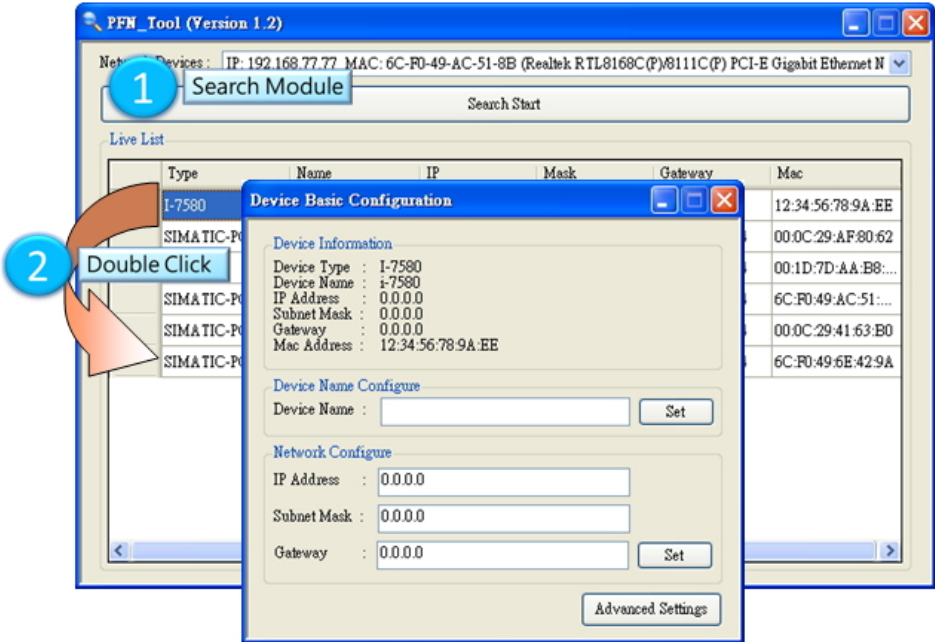

**Step 2: Set Device Name**

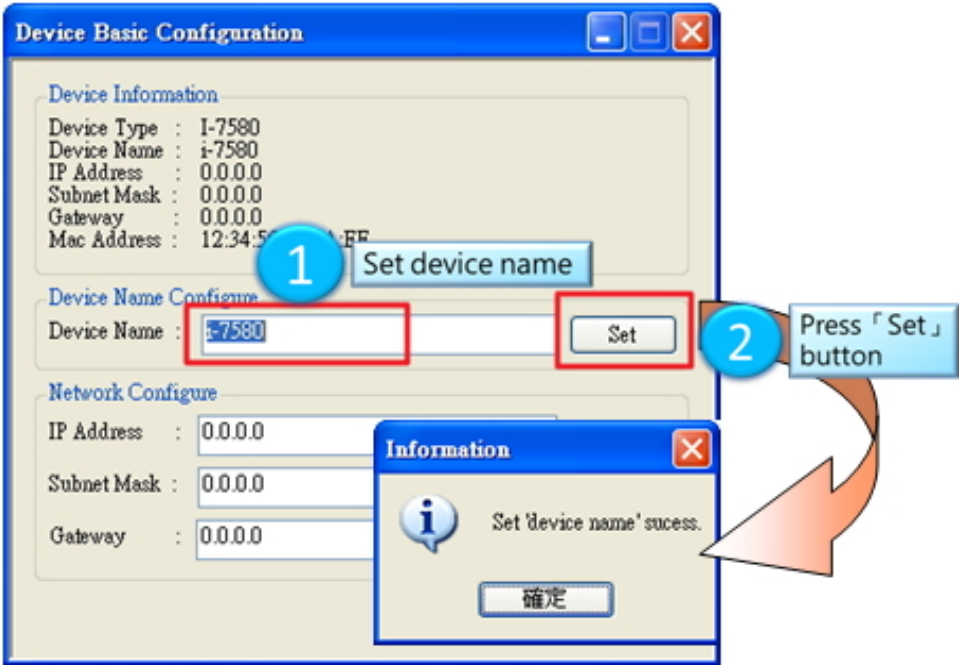

### Step 3: Set Network Parameters

The network parameter of I-7580 module must have the same domain and different IP with PC.

EX: PC's IP = 192.168.1.110

I-7580 module's IP = 192.168.1.111

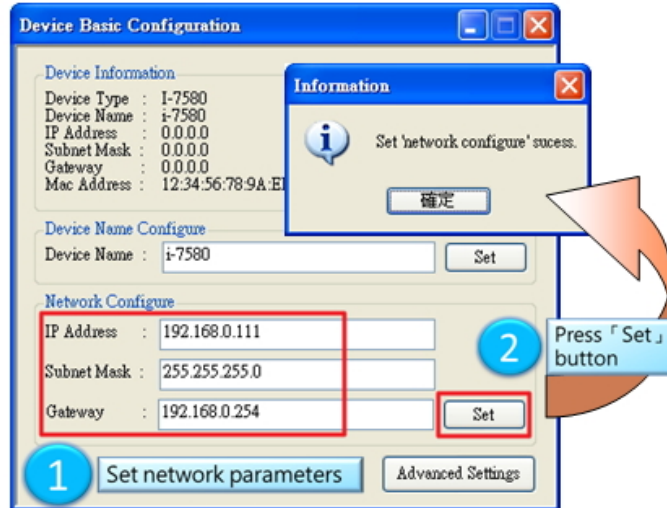

```
Connection-specific DNS Suffix . : 
Description . . . . . : Realtek RTL8168C(P)/8111C(P) PCI-E Gigabit Ethernet NIC
Physical Address. . . . . : 6C-F0-49-AC-51-8B
Dhcp Enabled. . . . . : No
IP Address. . . . . : 192.168.0.110
Subnet Mask . . . . . : 255.255.255.0
Default Gateway . . . . . : 192.168.0.254
DNS Servers . . . . . : 168.95.1.1
```

### Tips & Warnings



1. When PROFINET controller connect to I-7580 module (AP LED=ON), user can't set device name and network parameters.



# 6.2.3. Module Advanced Configuration

## Step 1: Open Device Advanced Configuration

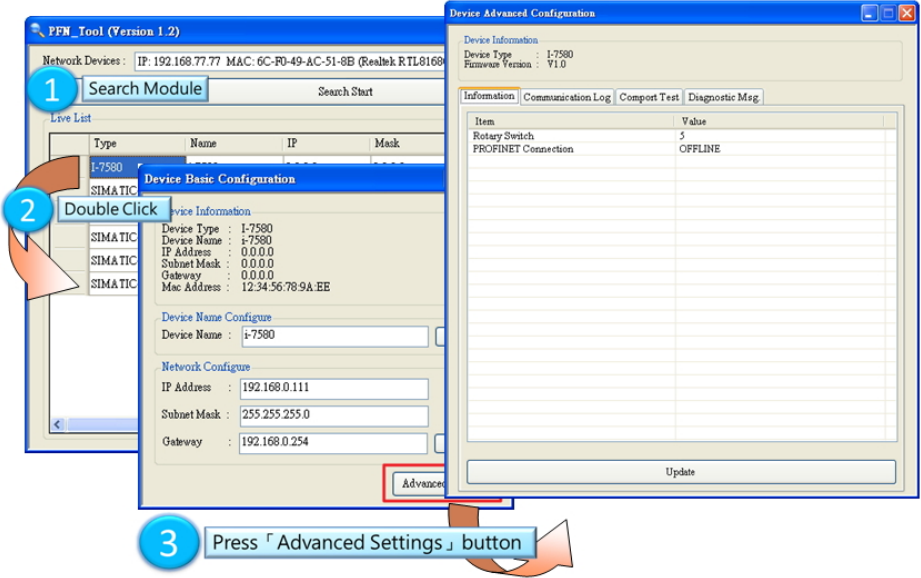

## Step 2: Advanced Configuration

Device Advanced Configuration of I-7580 has 4parts, they are (1)Information (2)Communication Log (3)Comport Test (4)Diagnostic Msg.

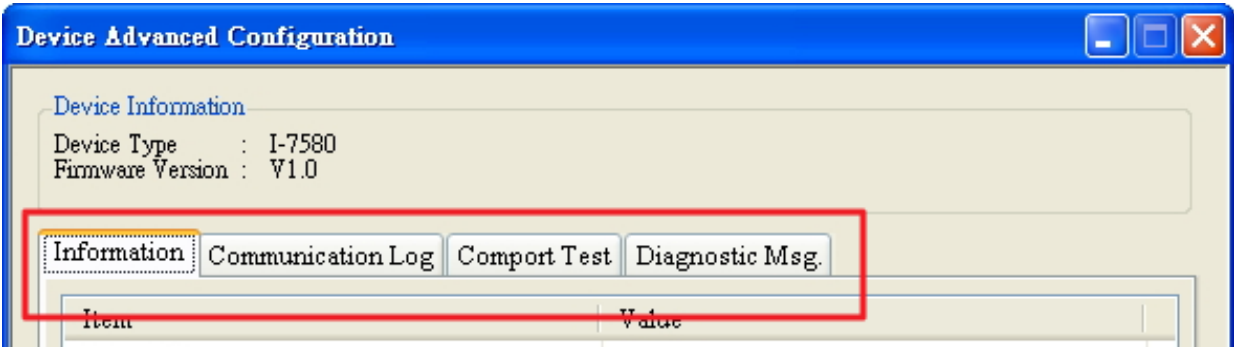



► **Information**

It shows all settings (ex. Module parameters or rotary switch value, etc...) of I-7580.

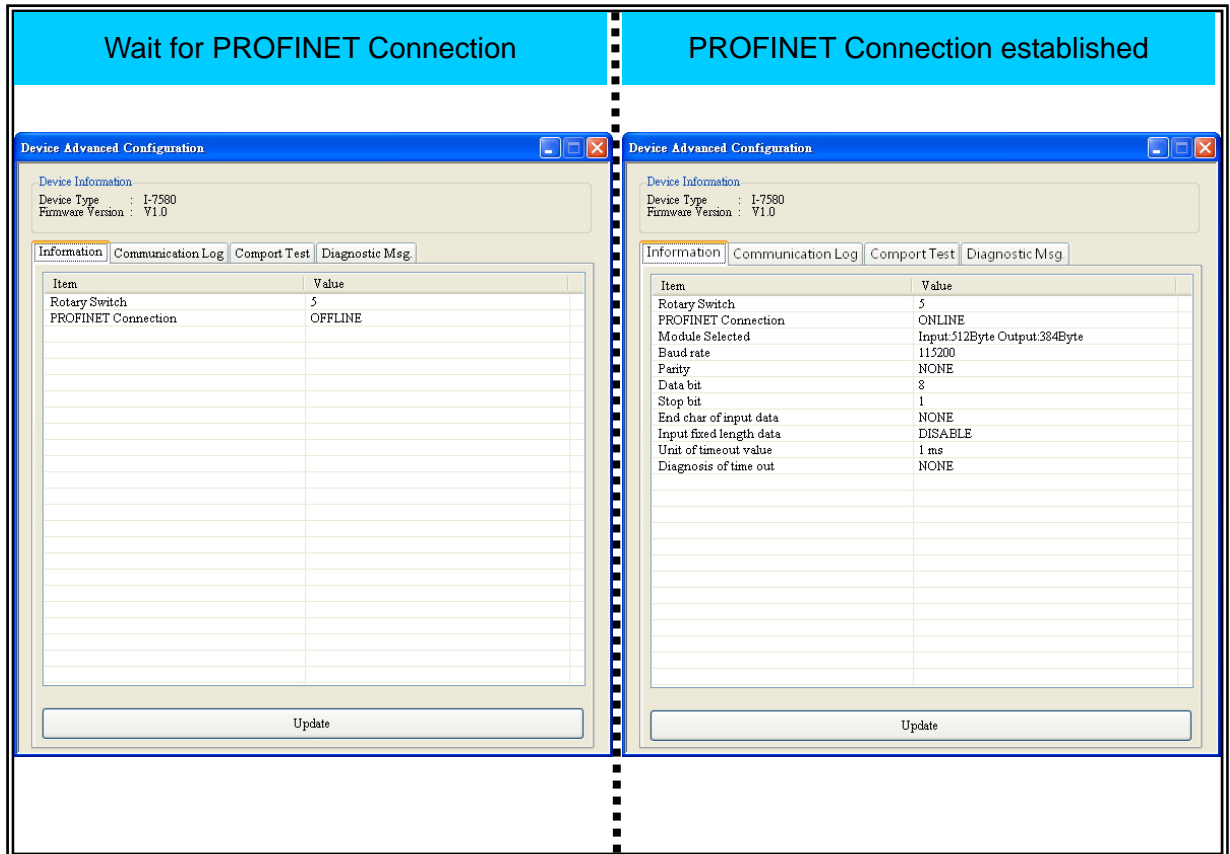

## ► Communication Log

It shows communication logs between I-7580 and serial devices connected with I-7580.

**1. Select data format**

**2. Press 「Update」 to update logs**

**Update logs ok**

**3. Binary format**

**1. Press 「Save」 to save logs**

**2. Save ok**

| # | Timestamp(ms) | Tx/Rx | Length | Data        |
|---|---------------|-------|--------|-------------|
| 1 | 35703         | Tx    | 8      | sendtoPC    |
| 2 | 26325         | Rx    | 13     | sendtoI7580 |

| # | Timestamp(ms) | Tx/Rx | Length | Data                                   |
|---|---------------|-------|--------|----------------------------------------|
| 1 | 6373          | Rx    | 13     | 73 65 6E 64 74 6F 69 37 35 38 30 0D 0A |
| 2 | 5667          | Tx    | 8      | 73 65 6E 64 74 6F 50 43                |

| # | Timestamp(ms) | Tx/Rx | Length | Data        |
|---|---------------|-------|--------|-------------|
| 1 | 35703         | Tx    | 8      | sendtoPC    |
| 2 | 26325         | Rx    | 13     | sendtoI7580 |

## ► Comport Test

User can test Communication between I-7580 and serial devices connected with I-7580 via PFN\_Tool.

**1. Set parameters and press 「Set」**

**2. Set COM port**

**3. Select ASCII/Binary Format**

**1. Input data and press 「Send」 to send data to PC**

**2. Send data successfully**

**1. Send data to I-7580**

**2. Press 「Update」 to update data**

**3. Receive data successfully**

**1. Press 「Reset」 to close COM port**

**2. Close COM port OK**

## ➤ Diagnostic Msg.

It shows diagnostic messages of I-7580.

1

2

3

Press 「Update」 to update diagnostic messages

Update OK

PROFINET input data area

Diagnostic messages

| Name          | Address | Display format | Monitor value |
|---------------|---------|----------------|---------------|
| "IState"      | %IB1    | DEC_unsigned   | 0             |
| "error state" | %IB2    | Hex            | 16#14         |
| "rx len"      | %IWS    | DEC_unsigned   | 0             |
| "rx cnt"      | %IWS    | DEC_unsigned   | 0             |

| Diag Data | Messages          | Descriptions  |
|-----------|-------------------|---------------|
| 0x04      | Output Data Error | Data Loss     |
| 0x10      | Input Data Error  | Data Overflow |

# 7. Configuration with Web Browser

---

## 7.1. Connecting to Web Server

Open web browser (ex. IE) and enter the IP address of the I-7580 module in the Address field and press “Enter” to connect to I-7580 module.

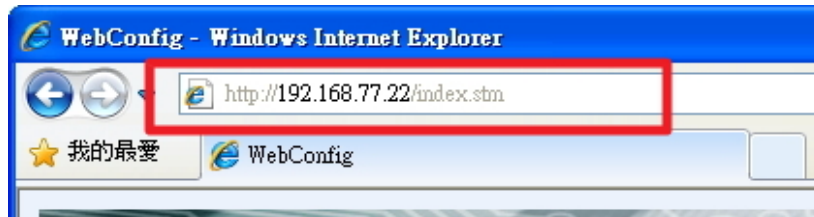

### Tips & Warnings

---



1. I-7580 has to set IP settings to connect to web server. Please follow the section **3.2. Network configuration=> Step 3: Set I-7580 module's name and IP** to set module's IP or follow the section **5.2. Using MiniOS7 Utility to get Ethernet settings and firmware version** or follow the section **6.2.2. Module Basic Configuration**.

## 7.2. Web Configuration



The left side(1) is the function menu and the other(2) is the setup page.

Function Menu:

- Home
- Communication Logs
- Comport Test
- Diagnostic Messages
- Information

### ► Home

---

It shows the introduction of I-7580.

I-7580 User Manual (Version 1.00, May/2014)

## ► Communication Logs

It shows communication logs between I-7580 and serial devices connected with I-7580.

The image displays three sequential screenshots of the 'Communication Log' interface, illustrating the process of selecting a log format and viewing the resulting data.

**Screenshot 1:** The 'Format' dropdown menu is open, showing 'ASCII' and 'Binary' options. A red arrow points to the 'ASCII' option with the text 'Select ASCII/Binary format'. The table below is empty.

| # | Timestamp (ms) | Tx/Rx | Length | Data |
|---|----------------|-------|--------|------|
|---|----------------|-------|--------|------|

**Screenshot 2:** The 'Format' dropdown is set to 'ASCII'. The table displays two log entries:

| # | Timestamp (ms) | Tx/Rx | Length | Data        |
|---|----------------|-------|--------|-------------|
| 1 | 56299          | Rx    | 13     | sendtoI7580 |
| 2 | 52539          | Tx    | 8      | sendtoPC    |

**Screenshot 3:** The 'Format' dropdown is set to 'Binary'. The table displays two log entries with hexadecimal data:

| # | Timestamp (ms) | Tx/Rx | Length | Data                                   |
|---|----------------|-------|--------|----------------------------------------|
| 1 | 56299          | Rx    | 13     | 73 65 6E 64 74 6F 69 37 35 38 30 0D 0A |
| 2 | 52539          | Tx    | 8      | 73 65 6E 64 74 6F 50 43                |

## ► Comport Test

User can test Communication between I-7580 and serial devices connected with I-7580 via web server.

**1. Set parameters and press 「Set」**  
**2. Select ASCII/Binary format**

**1. Input data and press 「Send」 to send data to PC**  
**2. Send data successfully**

**1. Send data to I-7580**  
**2. Press 「Update」 to update data**  
**3. Receive data successfully**

**Press 「Reset」 to close COM port**



## ➤ Diagnostic Messages

It will show diagnostic messages of I-7580.

The screenshot shows the 'Diagnostic Message Descriptions' interface. The left sidebar has a menu with 'Diagnostic Messages' highlighted. The main area shows 'Message Counts: 0' and 'Value: 0x00'. A table below has columns 'Diag Data', 'Messages', and 'Descriptions'. A red box highlights the 'Diagnostic Messages' menu item, with a red arrow pointing to it and a red box containing the text 'Click to update diagnostic messages'. A yellow box with the number '1' is in the bottom right corner.

Click to update diagnostic messages

1

---

The screenshot shows the 'Diagnostic Message Descriptions' interface. The left sidebar has a menu with 'Diagnostic Messages' highlighted. The main area shows 'Message Counts: 2' and 'Value: 0x14'. A table below has columns 'Diag Data', 'Messages', and 'Descriptions'. A red box highlights the table, with a red arrow pointing to it and a red box containing the text 'Diagnostic messages'. A yellow box with the number '2' is in the bottom right corner.

Diagnostic messages

2

| Diag Data | Messages          | Descriptions  |
|-----------|-------------------|---------------|
| 0x04      | Output Data Error | Data Loss     |
| 0x10      | Input Data Error  | Data Overflow |

| Name          | Address | Display format | Monitor value |
|---------------|---------|----------------|---------------|
| "IState"      | %IB1    | DEC_unsigned   | 0             |
| "error state" | %IB2    | Hex            | 16#14         |
| "rcv len"     | %IW3    | DEC_unsigned   | 0             |
| "rcv cnt"     | %IW5    | DEC_unsigned   | 0             |

PROFINET input data area

## ► Information

It shows all settings (ex. Module parameters or rotary switch value, etc...) of I-7580.

| Device Information                 |                                                | Module Information        |                                                           |
|------------------------------------|------------------------------------------------|---------------------------|-----------------------------------------------------------|
| <b>Device Information</b>          |                                                | <b>Module Information</b> |                                                           |
| <b>HARDWARE:</b>                   |                                                |                           |                                                           |
| MAC Address:                       | <input type="text" value="12:34:56:78:9a:bc"/> | Rotary Switch:            | <input type="text" value="5"/>                            |
| Device Hardware Revision:          | <input type="text" value="1"/>                 | PROFINET Connection:      | <input type="text" value="ONLINE"/>                       |
| <b>NETWORK INTERFACE FIRMWARE:</b> |                                                |                           |                                                           |
| Industrial Ethernet Protocol:      | <input type="text" value="PROFINET"/>          | Module Selected:          | <input type="text" value="Input:512Byte Output:384Byte"/> |
| Firmware Version:                  | <input type="text" value="3.3"/>               | Baudrate(bps):            | <input type="text" value="115200"/>                       |
| <b>SOFTWARE:</b>                   |                                                |                           |                                                           |
| User Software Version:             | <input type="text" value="1.0.0"/>             | Parity:                   | <input type="text" value="NONE"/>                         |
| <b>IP STATUS:</b>                  |                                                |                           |                                                           |
| IP address:                        | <input type="text" value="192.168.77.22"/>     | Data bit:                 | <input type="text" value="8"/>                            |
| Subnet mask:                       | <input type="text" value="255.255.0.0"/>       | Stop bit:                 | <input type="text" value="1"/>                            |
| Gateway:                           | <input type="text" value="192.168.77.22"/>     | End char of input data:   | <input type="text" value="NONE"/>                         |
|                                    |                                                | Input fixed length data:  | <input type="text" value="DISABLE"/>                      |
|                                    |                                                | Unit of timeout value:    | <input type="text" value="1 ms"/>                         |
|                                    |                                                | Diagnosis of timeout:     | <input type="text" value="NONE"/>                         |

## 8. Troubleshooting

| Item | Trouble state                                                                               | Solution                                                                                                                                                                                                                                                                                                                                                         |
|------|---------------------------------------------------------------------------------------------|------------------------------------------------------------------------------------------------------------------------------------------------------------------------------------------------------------------------------------------------------------------------------------------------------------------------------------------------------------------|
| 1    | 'AP', 'BOOT' and 'ERR' LED are always off.                                                  | The power supply of I-7580 module has some problems. Please check the wire connection of the power and the voltage is between 10~30V <sub>DC</sub> .                                                                                                                                                                                                             |
| 2    | 'AP' and 'BOOT' LED are always off and 'ERR' LED is always flash per 500ms.                 | That means the I-7580 module can't connect to the PROFINET IO controller. Please check the wire connection and module configuration (include network settings, device name) and project configuration of engineering tool that provide by PROFINET IO controller's manufacturer.                                                                                 |
| 3    | 'AP' LED is always on and 'BOOT' LED is always off and 'ERR' LED is always flash per 500ms. | It means that the value of rotary switch does not match the settings of the modules(please refer to section 4.2. Module configuration).                                                                                                                                                                                                                          |
| 4    | 'BOOT' LED is always on.                                                                    | It means the I-7580 module is at Bootloader mode. Please set the I-7580 module to AP mode.                                                                                                                                                                                                                                                                       |
| 5    | Can't find any I-7580 module by MiniOS7 Utility                                             | It means the IP address of I-7580 module is zero (default IP = 0.0.0.0). At this time, please follow the section 3.2. Network configuration => Step 3: Set I-7580 module's name and IP" to set module's IP and then re-search the network again. Or, wait for the PROFINET controller connect to I-7580 module (AP LED=ON) and then re-search the network again. |
| 6    | Can't find any I-7580 module by PFN_Tool Utility                                            | <ol style="list-style-type: none"> <li>Please check the wire connection</li> <li>Please set the I-7580 module to AP mode, please refer to the section 1.5. → Rotary Switch.</li> <li>Please check network card is ok, and I-7580 module and network card have to in the same network.</li> </ol>                                                                 |