

# GW-7553 (Modbus RTU Slave) example for SIMATIC STEP 7

System Architecture: GW-7553 is a PROFIBUS slave and Modbus slave device.

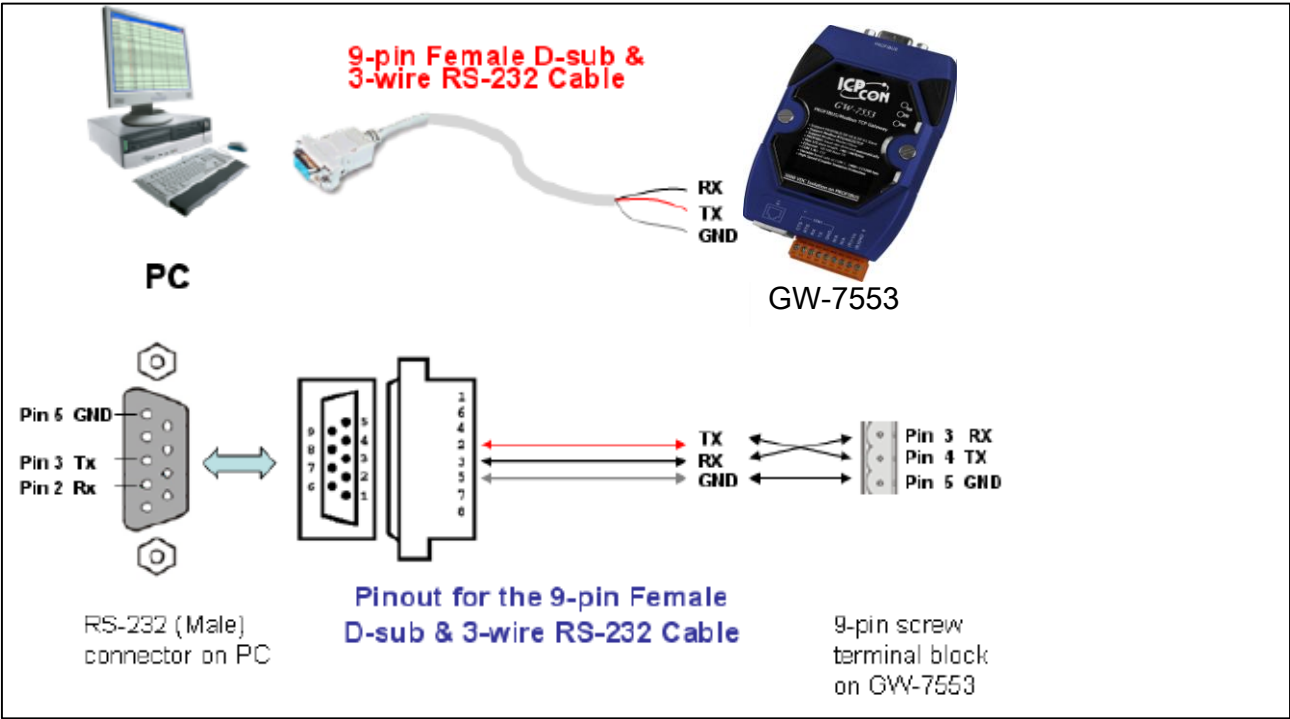
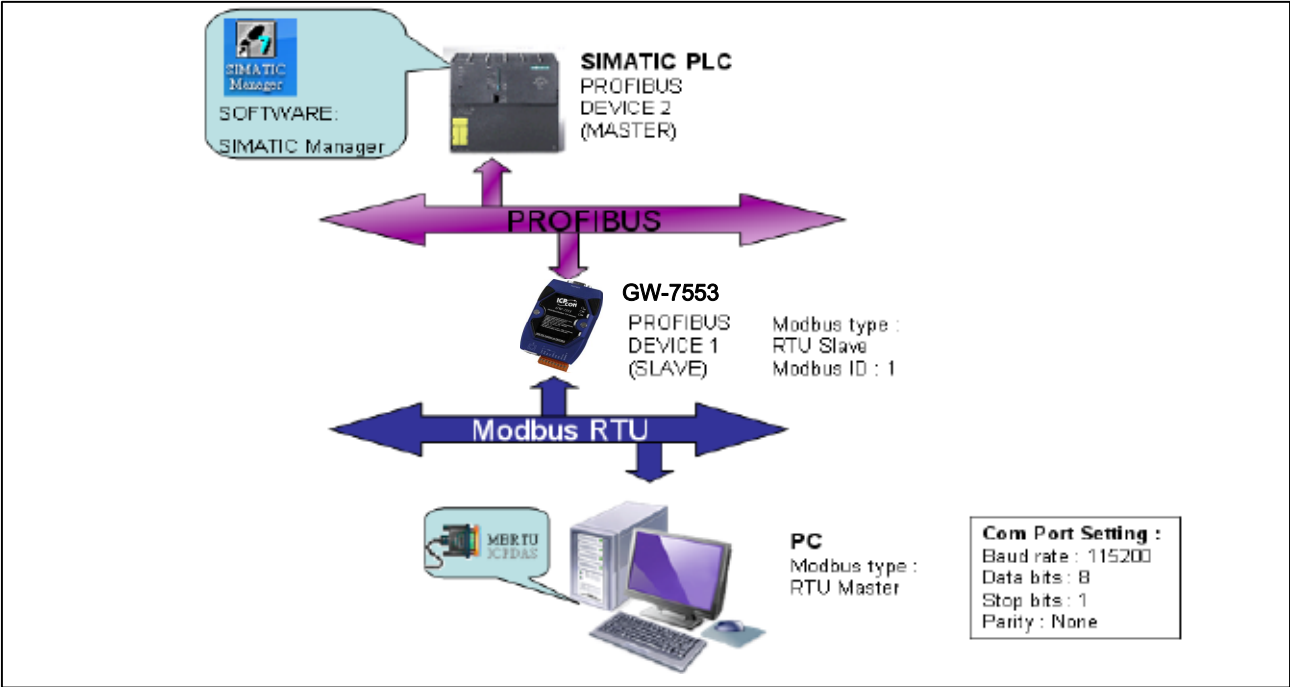

## Directory

[Example 1:Receives AO data from Modbus master.](#)

[Example 2: Rceives DO data from Modbus master.](#)

[Example 3: Rereshes DI data to Modbus master.](#)

[Example 4: Rereshes AI data to Modbus master.](#)

## Example 1: PLC receives AO data from Modbus master.

### SIMATIC STEP 7 Edit

1. HW Config. – configure GW-7553 (ex: System setting module x1, Input Register—2 word module x1)

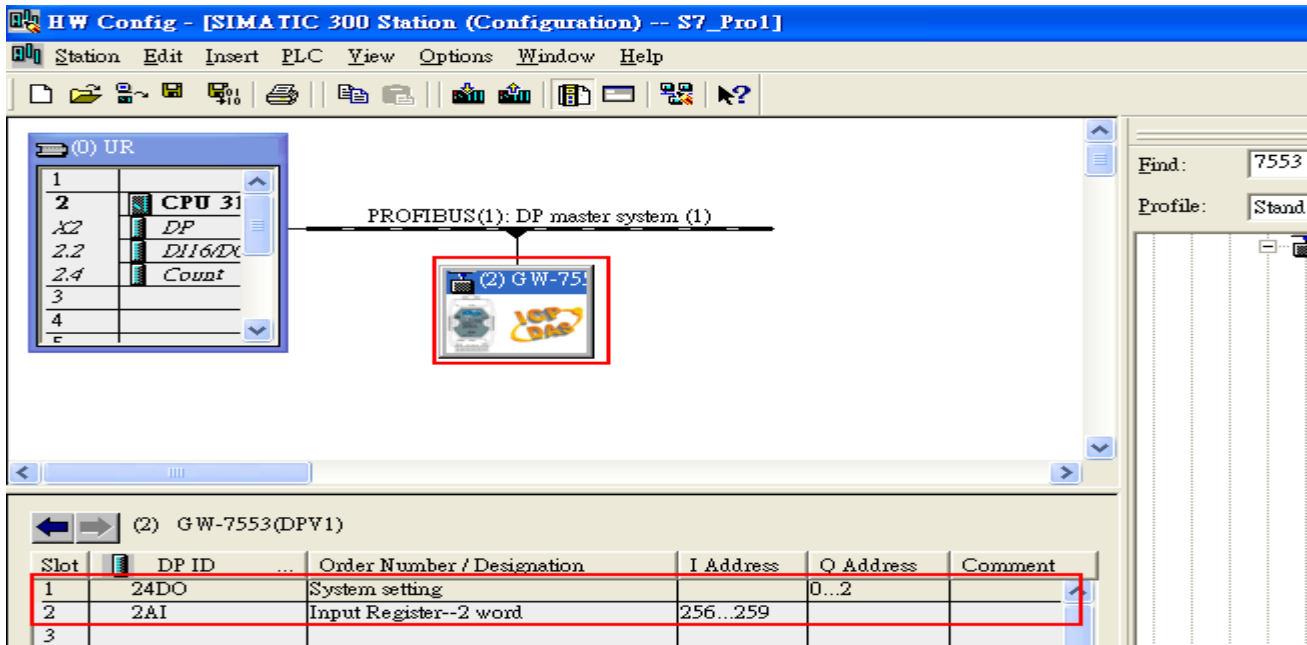

2. HW Config – Parameter assignment (ex: Com port settings, **Modbus type: Slave**, **Modbus format: RTU**, **Byte Order: Big Endian**). Confirm the GW-7553's Com Port setting is the same with MBRTU tool (ex: **baud rate-115200**, **data bits-8**, **stop bits-1**, **parity-none**). About the MBRTU tool, please refer to the “Communication test” in the below.

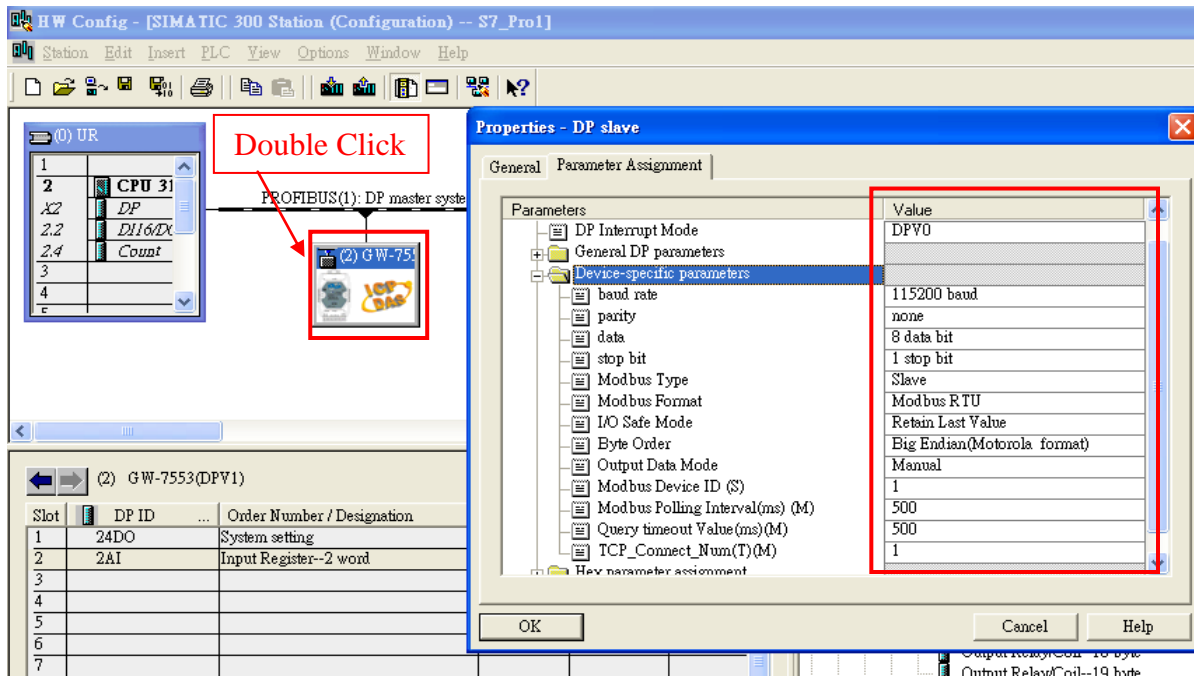

### 3. Save and Compile

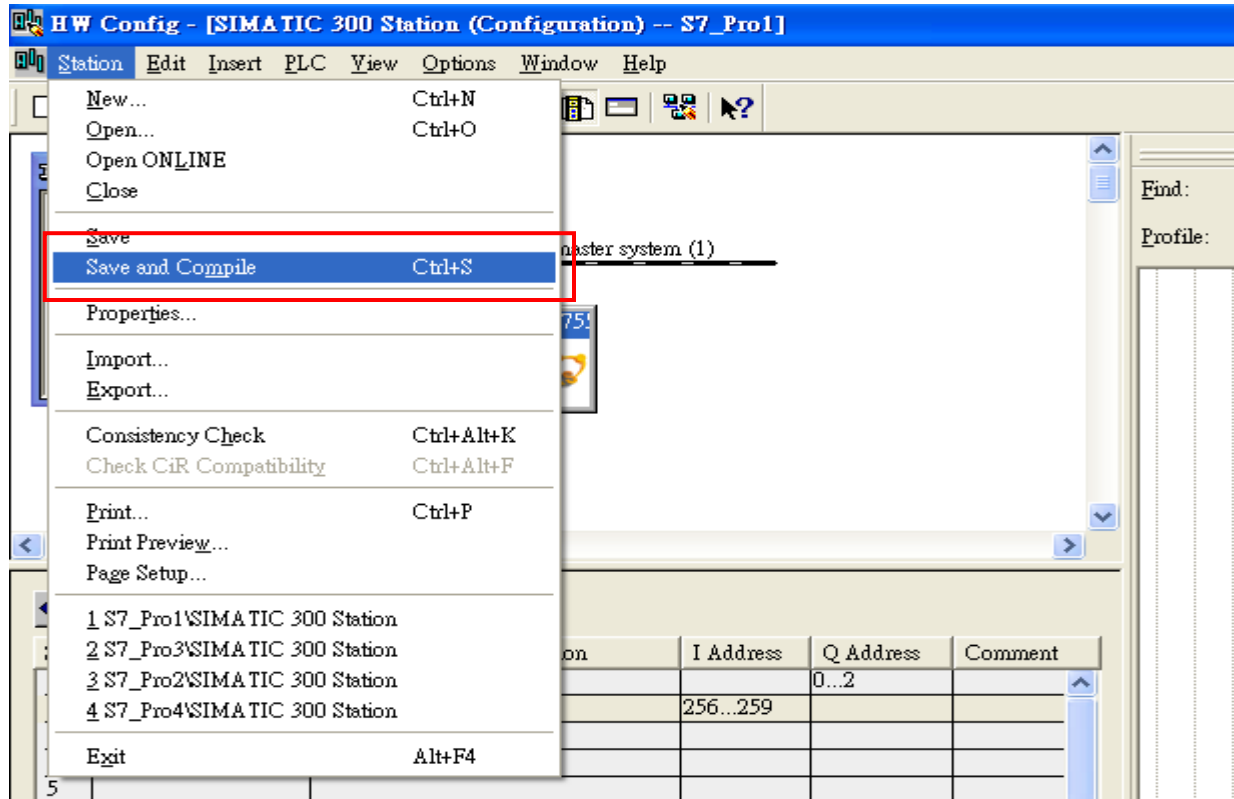

### 4. Download setting into STEP 7

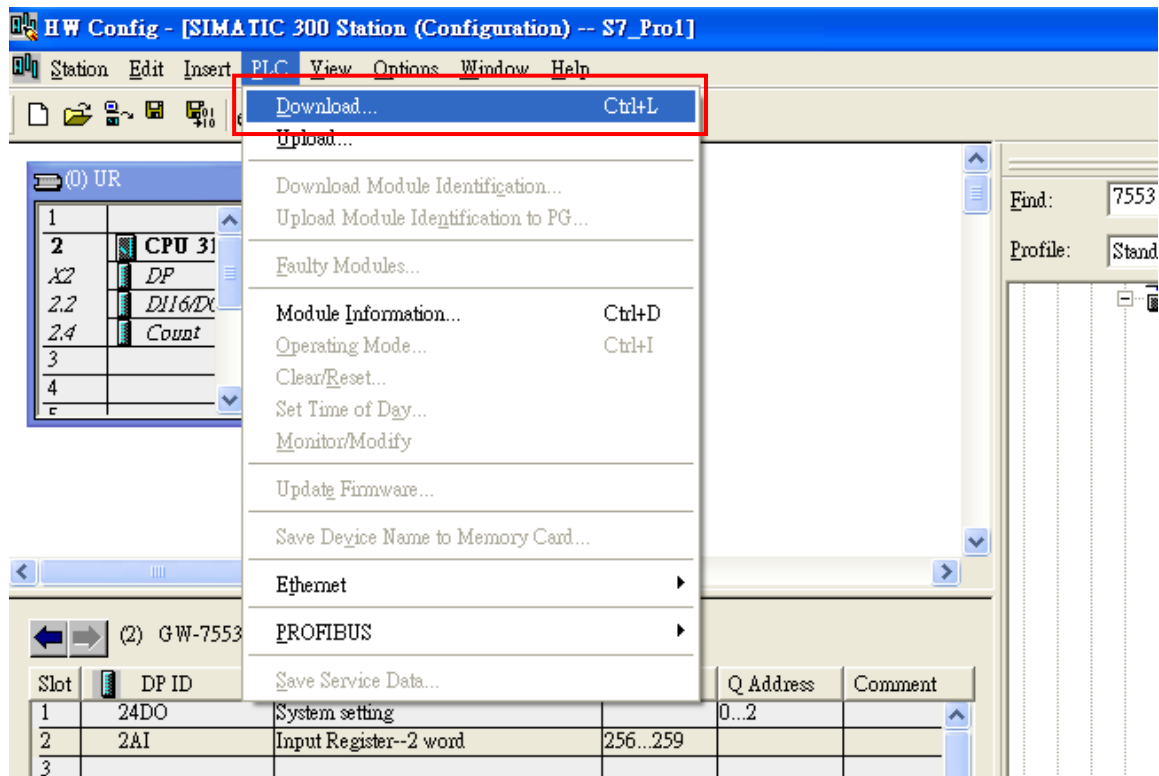

5. Insert a new Organization Block (OB1,OB82,OB86)

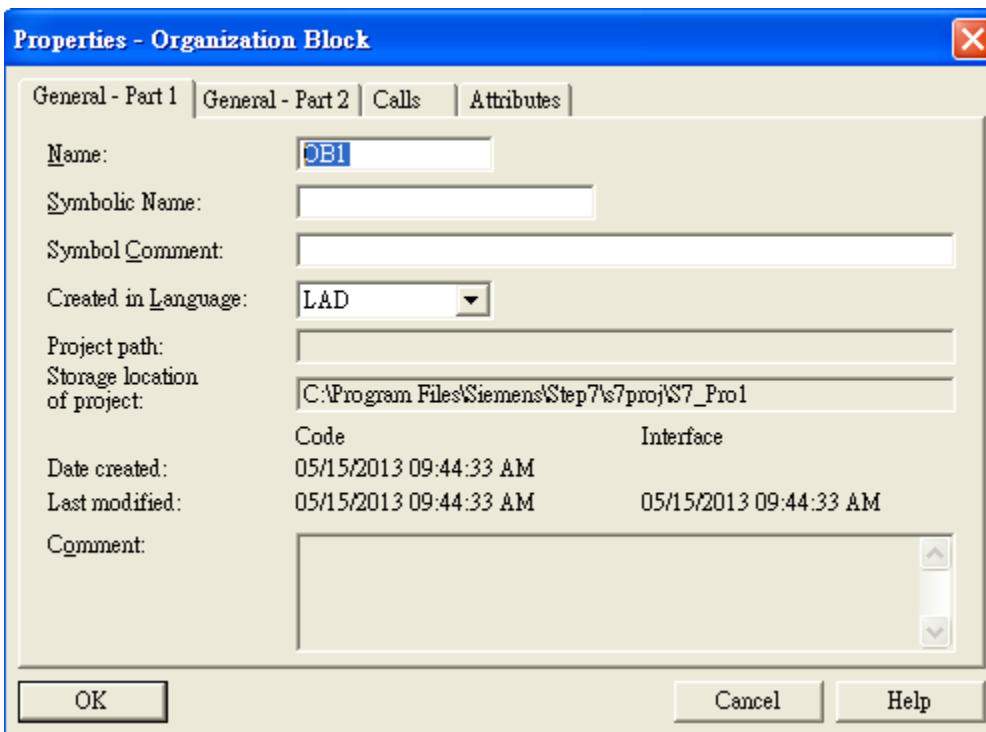
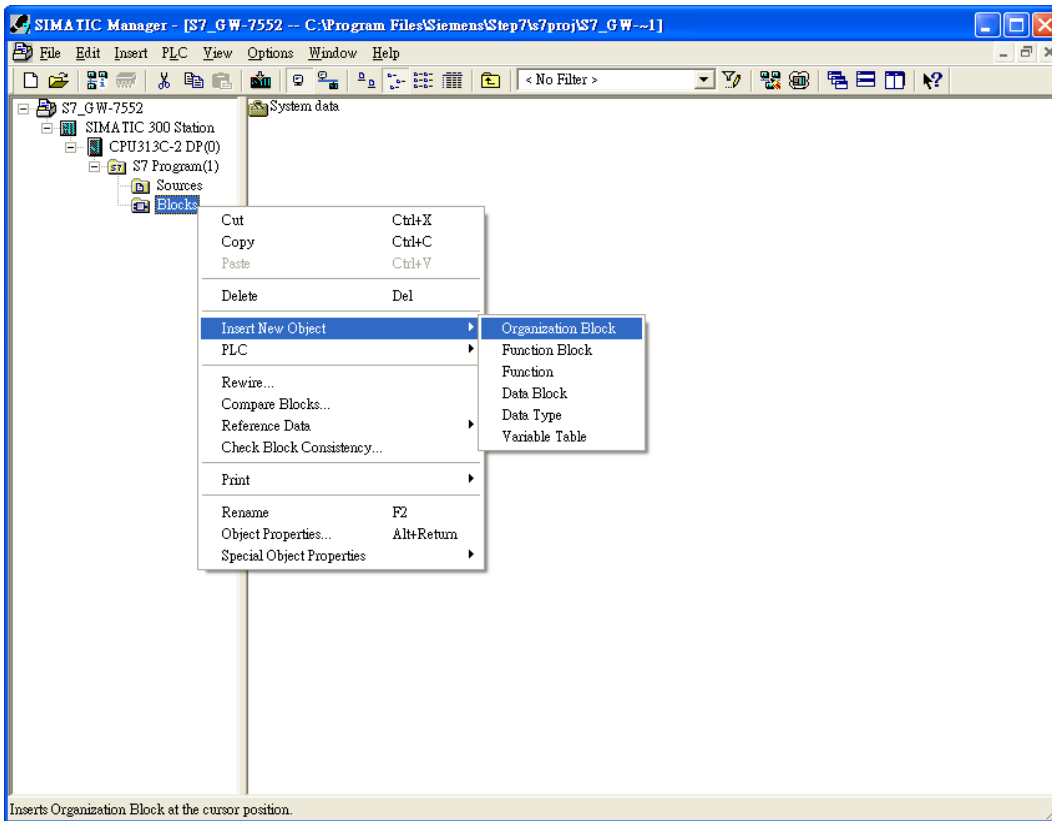

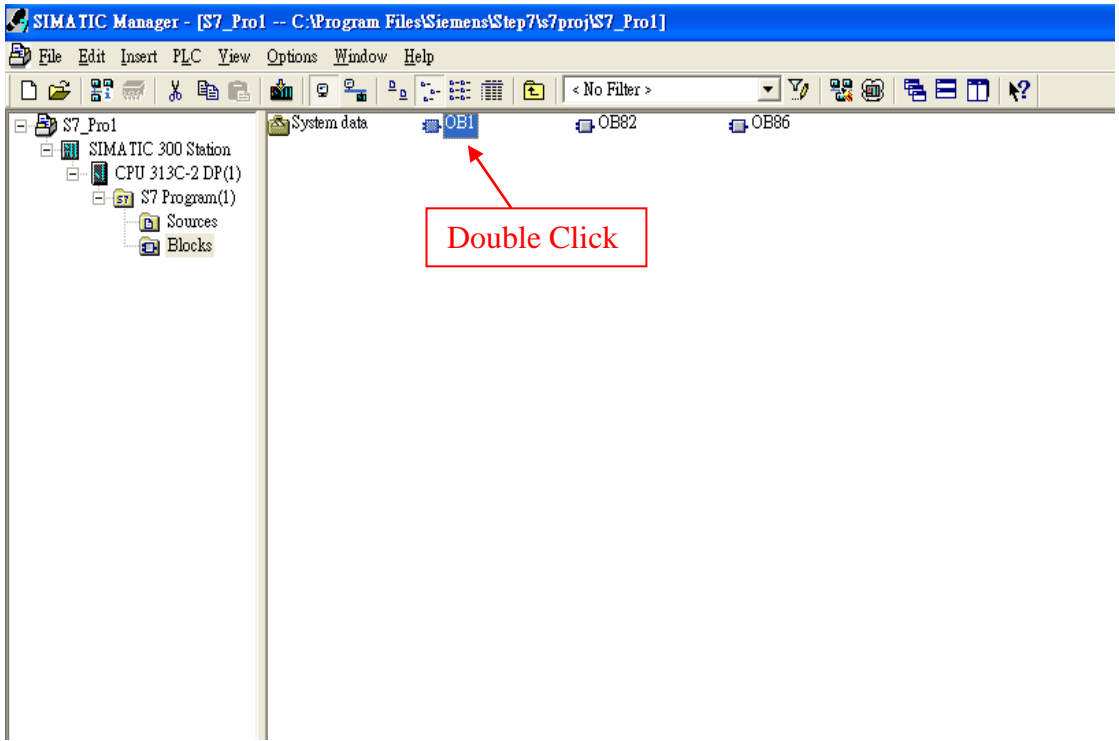

6.S7 program edit

Variables used in the example LD Program:

Contents Of: 'Environment\Interface\TEMP'

Name	Data Type	Address	Comment
OB1_SCAN_1			
OB1_PRIORITY			
OB1_OB_NUMBR	Byte	3.0	1 (Organization block 1, OB1)
OB1_RESERVED_1	Byte	4.0	Reserved for system
OB1_RESERVED_2	Byte	5.0	Reserved for system
OB1_PREV_CYCLE	Int	6.0	Cycle time of previous OB1 scan (milliseconds)
OB1_MIN_CYCLE	Int	8.0	Minimum cycle time of OB1 (milliseconds)
OB1_MAX_CYCLE	Int	10.0	Maximum cycle time of OB1 (milliseconds)
OB1_DATE_TIME	Date_And_Time	12.0	Date and time OB1 started
END	Bool	20.0	
TEMPO	Word	22.0	
TEMP1	Word	24.0	

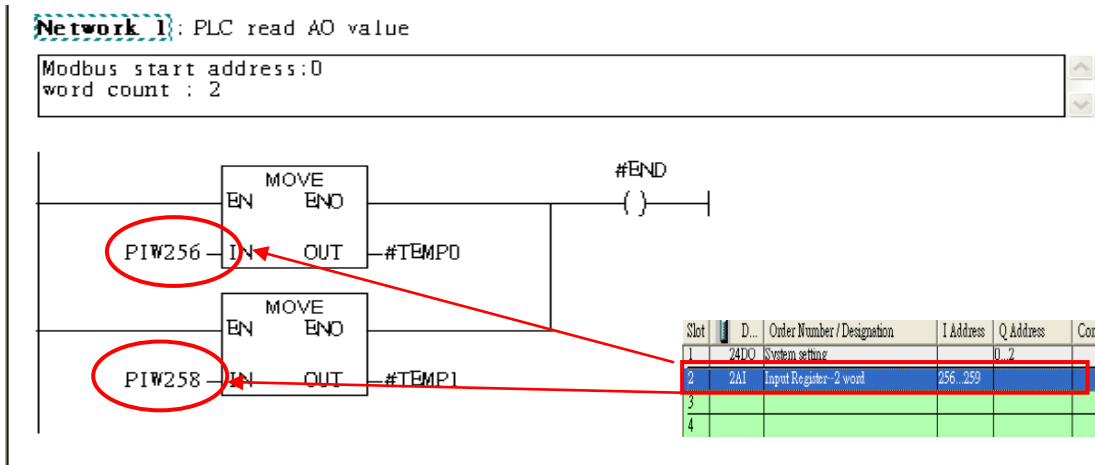

## 7. S7 program download

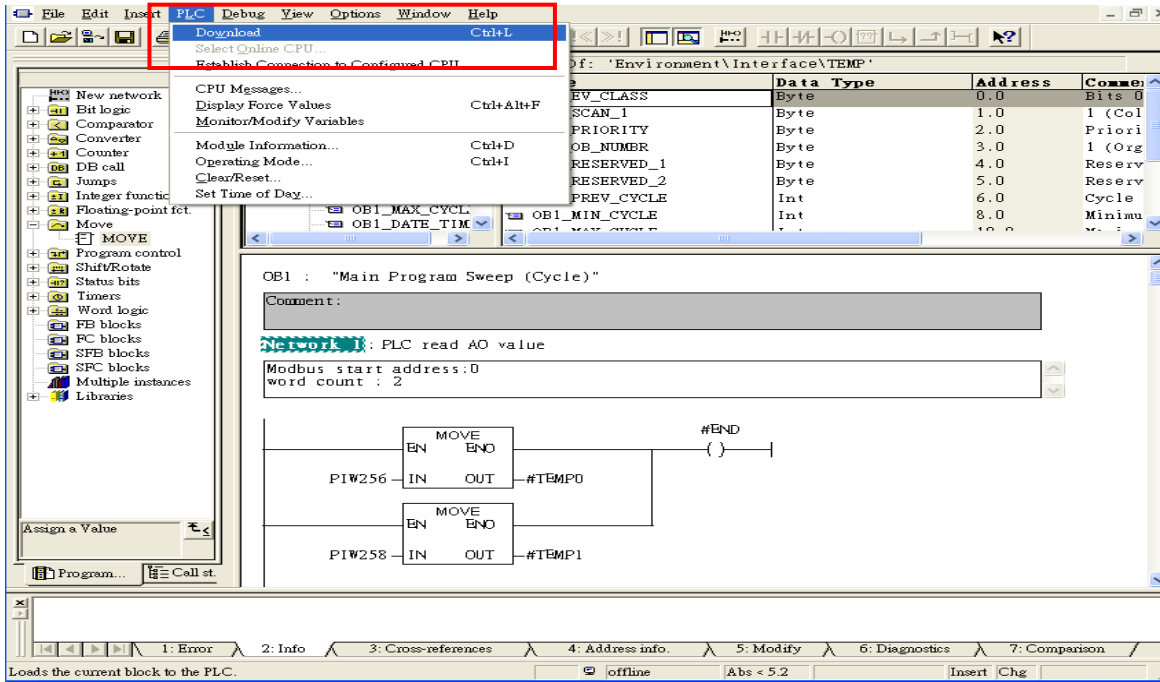

8. Make sure the RUN LED of the GW-7553 is on and the switch of the GW-7553 is at Normal mode.



## Communication test

1. Confirm the GW-7553's Com Port setting is the same with Modbus Master tool (ex: MBRTU, you can download MBRTU from [http://ftp.icpdas.com.tw/pub/cd/8000cd/napdos/modbus/modbus\\_utility/](http://ftp.icpdas.com.tw/pub/cd/8000cd/napdos/modbus/modbus_utility/))

Com Port Settings: baud rate-115200, data bits-8, stop bits-1, parity-none

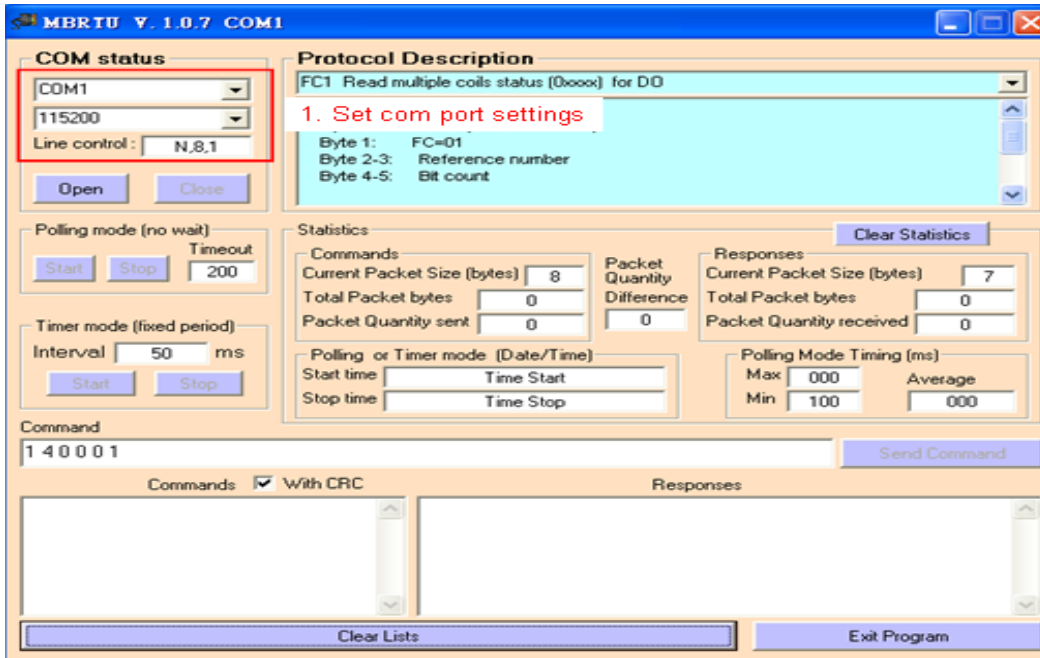

2. Click "Send Command" button to write AO value (0x1122, 0x3344)

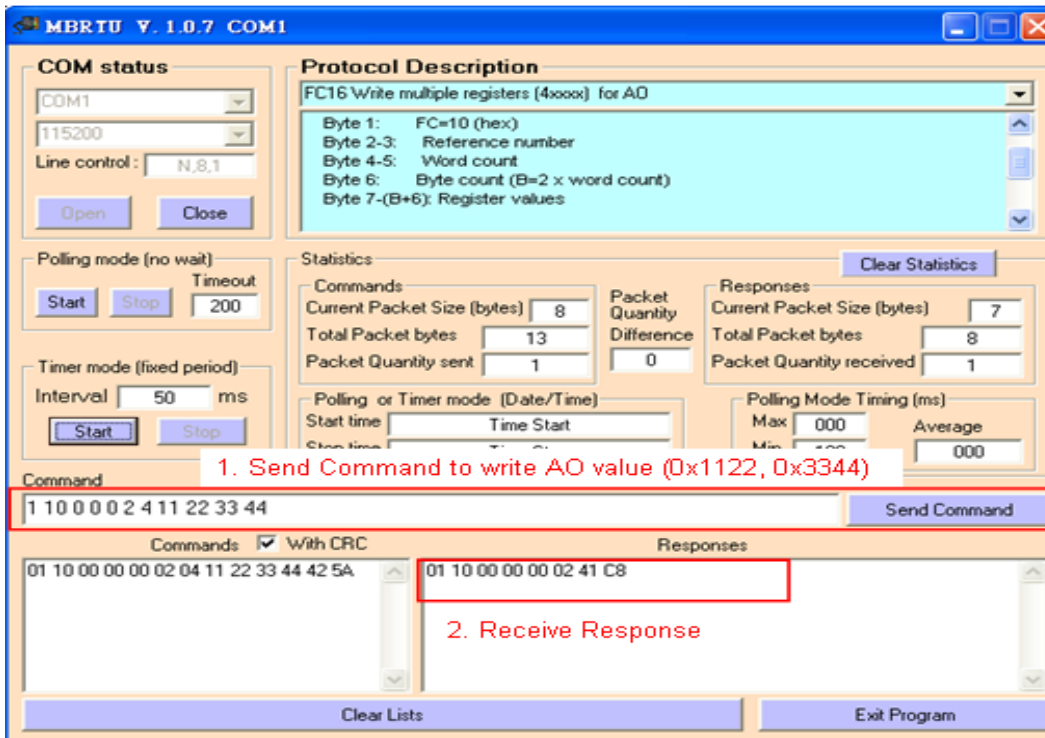



3. PLC will receives the "AI Value (0x1122, 0x3344)" at PLC address PIW256&PIW258

OBI : "Main Program Sweep (Cycle)"

GW-7522 is

Profibus Slave  
Modbus Slave

**Network 1**: PLC r

Modbus start address:0  
word count : 2

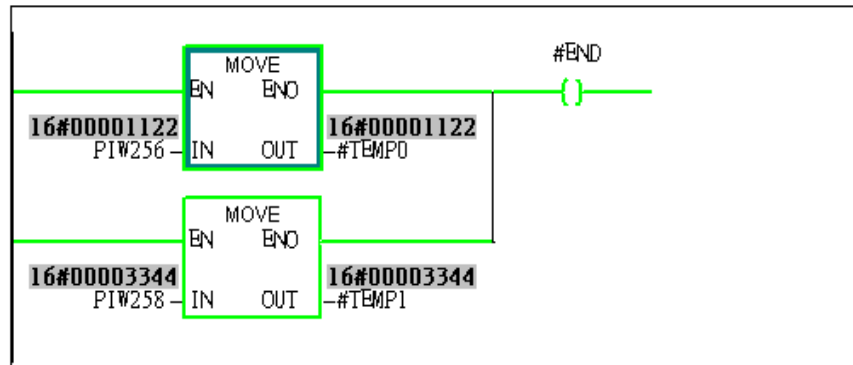

## Example 2: PLC receives DO data from Modbus master.

### SIMATIC STEP 7 Edit

1. HW Config. – configure GW-7553 (ex: System setting module x1, Input Relay/Coil – 2 byte module x1)

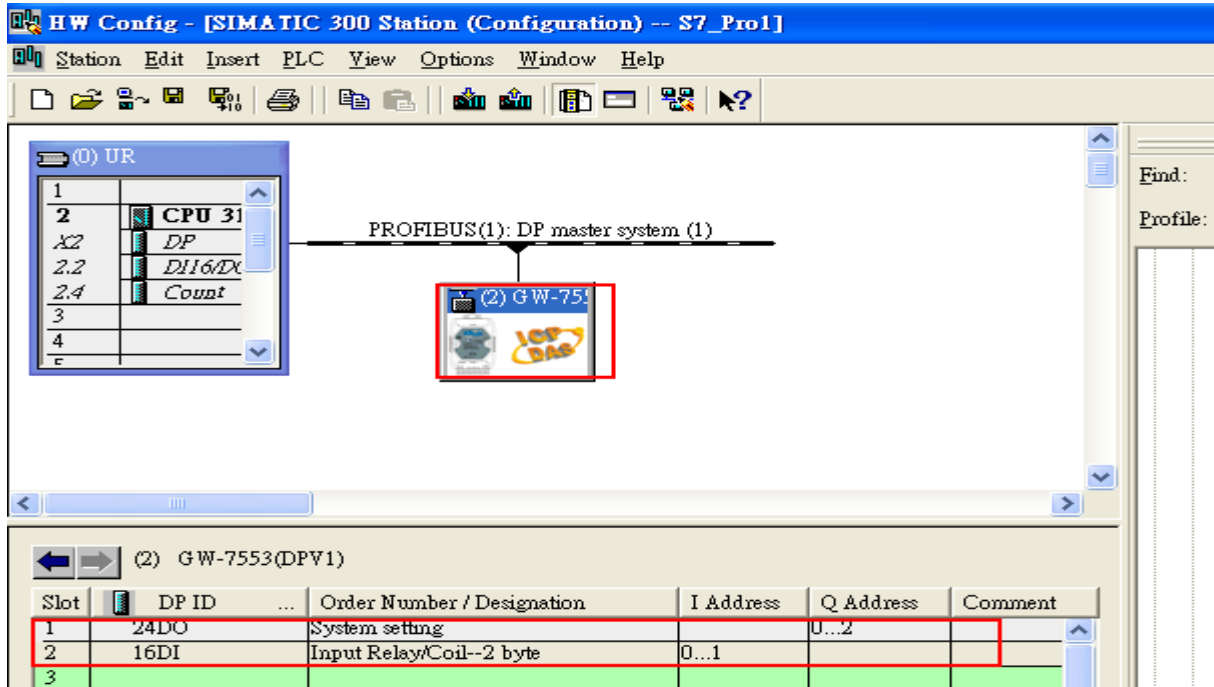

2. HW Config – Parameter assignment (ex: Com port settings, Modbus type: Slave, Modbus format: RTU, Byte Order: Big Endian). Confirm the GW-7553's Com Port setting is the same with MBRTU tool (ex: baud rate-115200, data bits-8, stop bits-1, parity-none). About the MBRTU tool, please refer to the “Communication test” in the below.

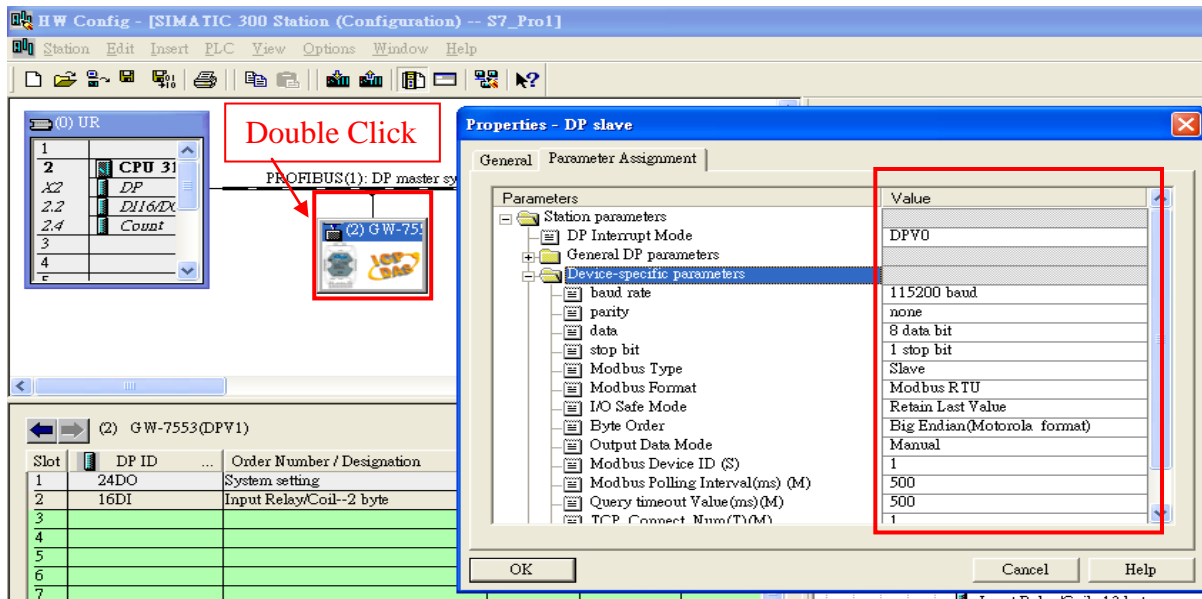

### 3. Save and Compile

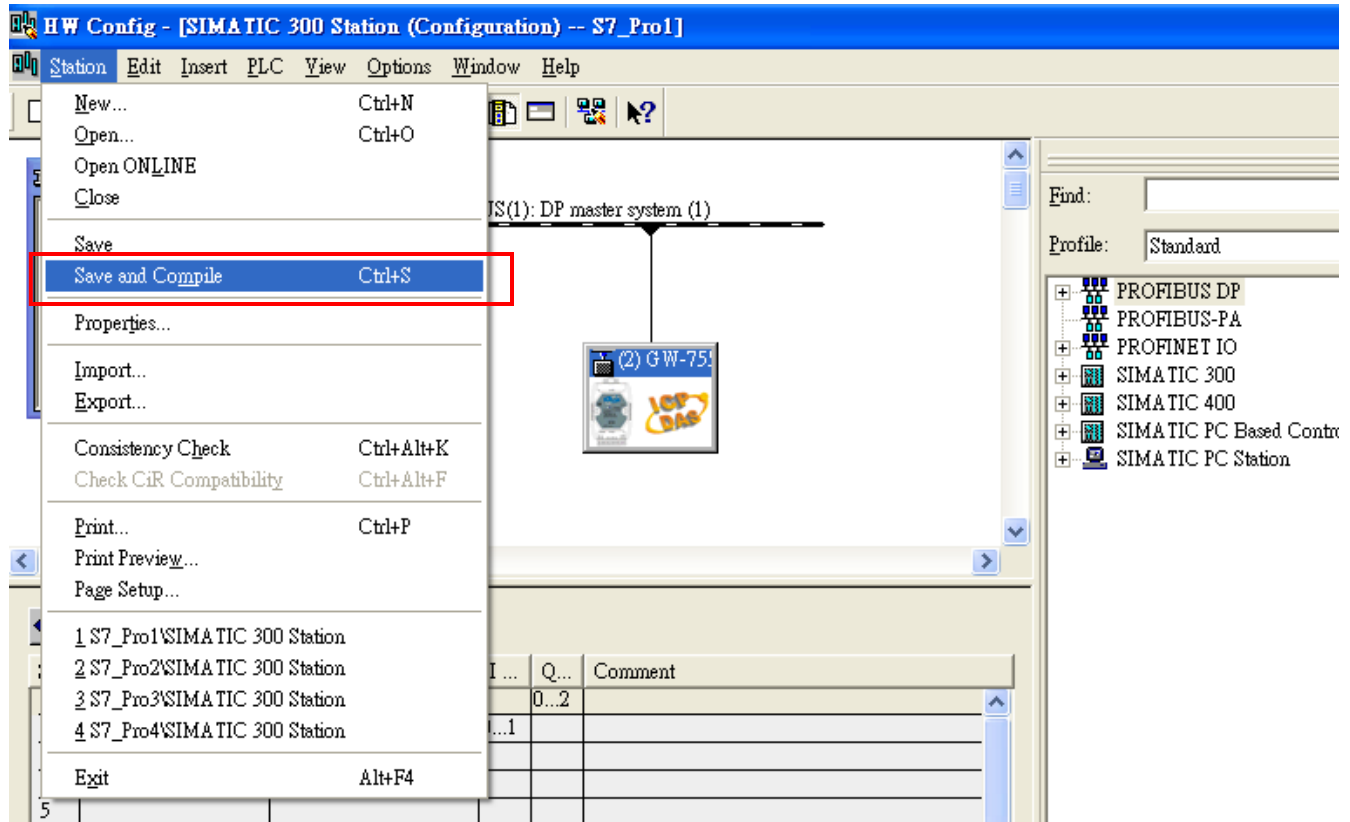

### 4. Download setting into STEP 7

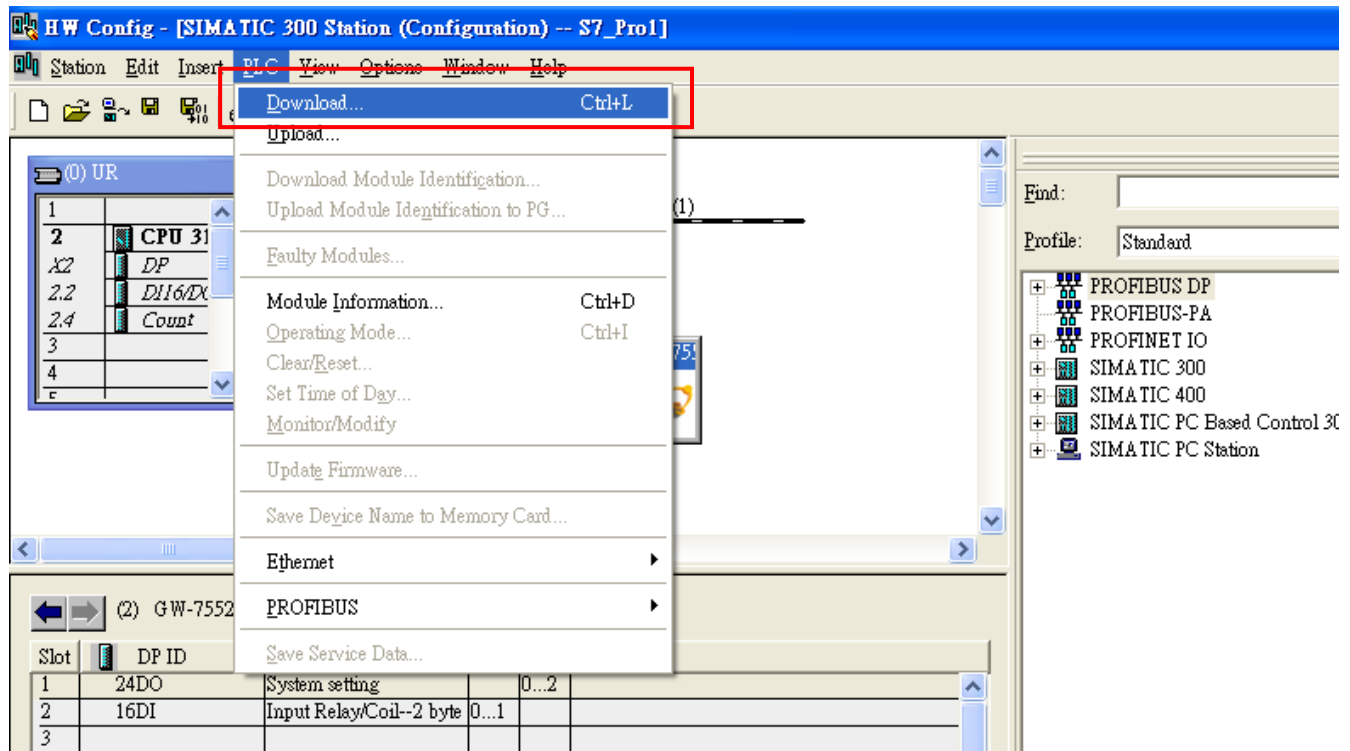

5. Insert a new Organization Block (OB1,OB82,OB86)

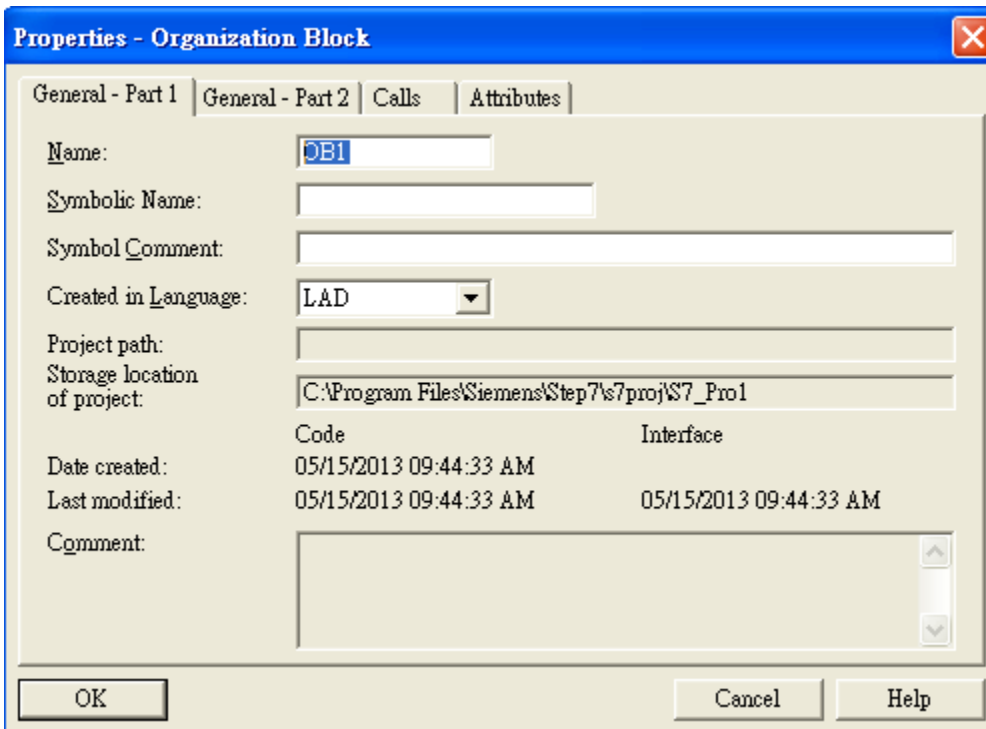
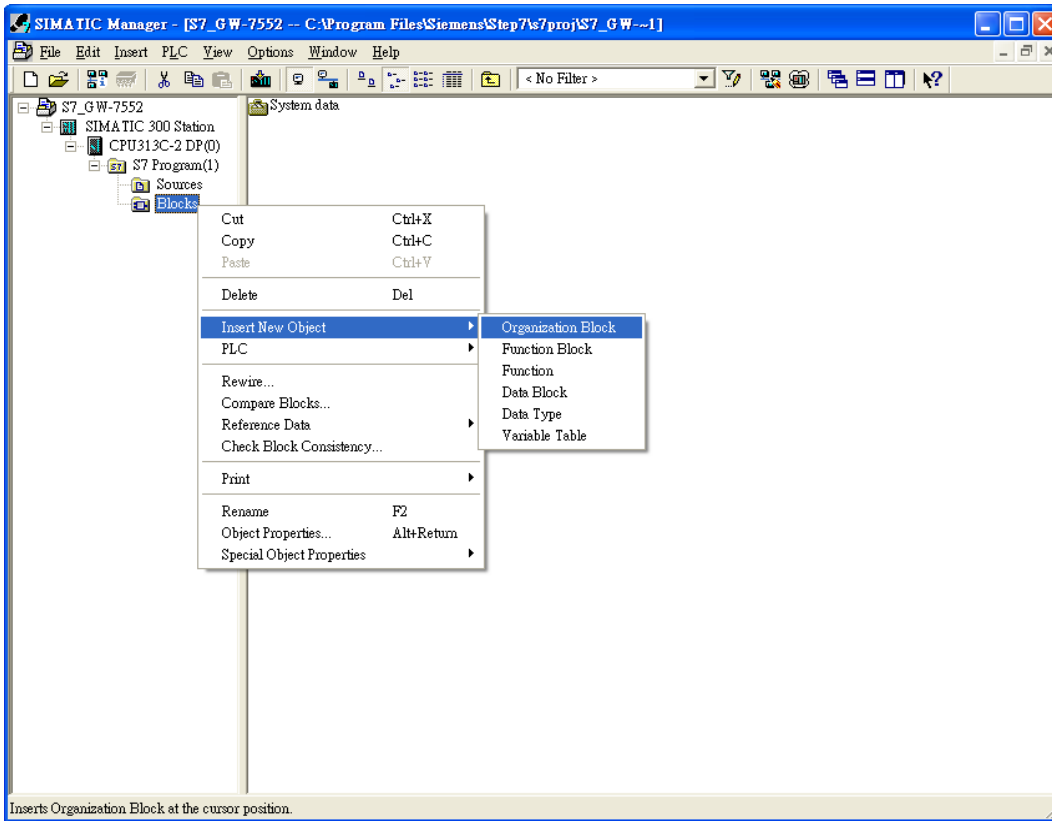

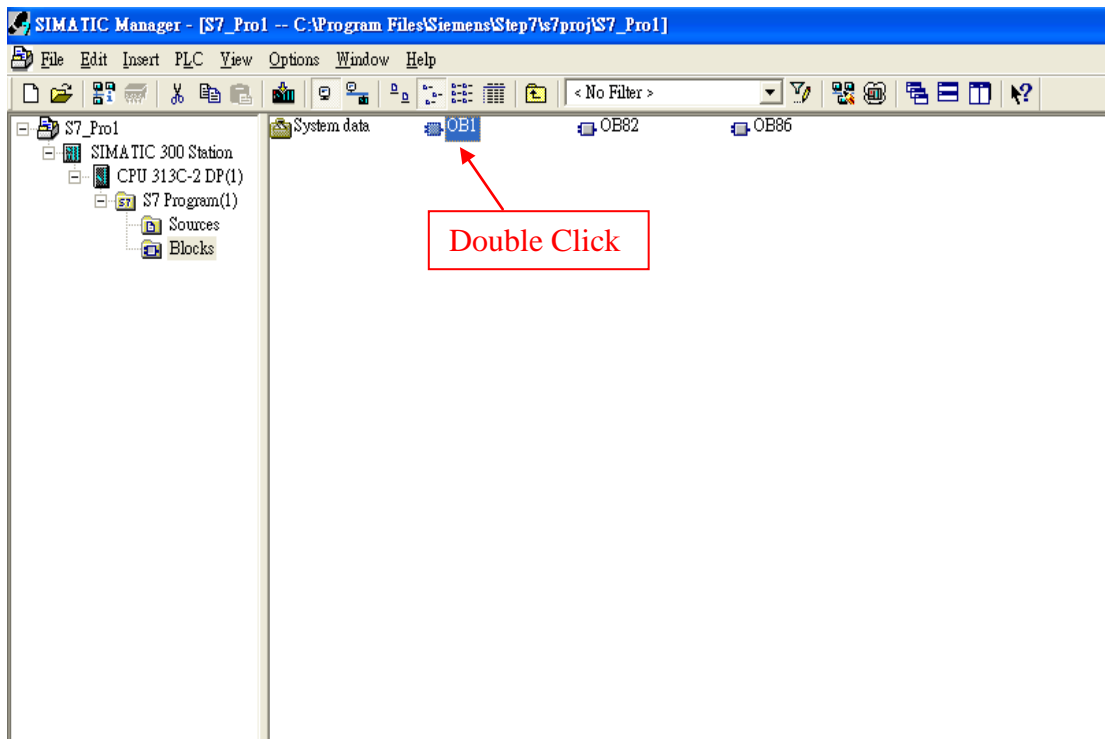

## 6. S7 program edit

Variables used in the example LD Program:

Name	Data Type	Address	Comment
OB1_DAT...	Date_...	12.0	Date and time OB1 started
END	Bool	20.0	
temp1	Byte	21.0	
temp2	Byte	22.0	

**Network 1**: Title:

Comment:

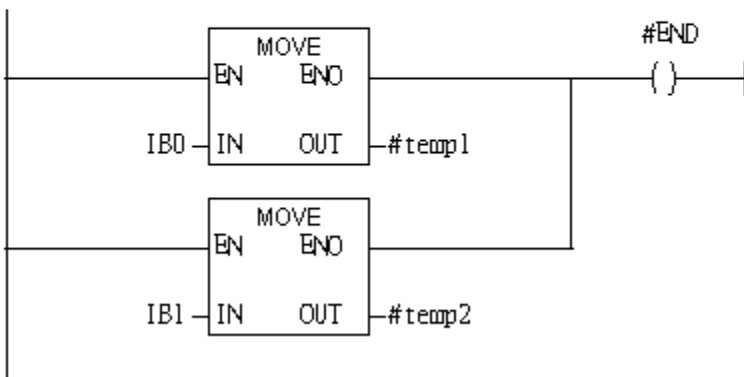

## 7. S7 program download

The screenshot shows the SIMATIC Manager interface. The 'Download' menu is open, displaying options such as 'Select Online CPU...', 'Establish Connection to Configured CPU', 'CPU Messages...', 'Display Force Values', 'Monitor/Modify Variables', 'Module Information...', 'Operating Mode...', 'Clear/Reset...', and 'Set Time of Day...'. The 'Monitor/Modify Variables' option is highlighted. Below the menu, a table lists variables:

Name	Data Type	Address	Comment
OB1_DAT...	Date_...	12.0	Date and time OB1 s...
END	Bool	20.0	
temp1	Byte	21.0	
temp2	Byte	22.0	

Below the table, the 'Network 1' configuration is shown with fields for 'Title:' and 'Comment:'. The ladder logic diagram for Network 1 consists of two 'MOVE' blocks. The first block has 'IB0' as the input and '#temp1' as the output. The second block has 'IB1' as the input and '#temp2' as the output. Both outputs are connected to a common output line that leads to a coil labeled '#END'.

8. Make sure the RUN LED of the GW-7553 is on and the switch of the GW-7553 is at Normal mode.



## Communication test

1. Confirm the GW-7553's Com Port setting is the same with Modbus Master tool (ex: MBRTU, you can download MBRTU from [http://ftp.icpdas.com.tw/pub/cd/8000cd/napdos/modbus/modbus\\_utility/](http://ftp.icpdas.com.tw/pub/cd/8000cd/napdos/modbus/modbus_utility/))

Com Port Settings: baud rate-115200, data bits-8, stop bits-1, parity-none

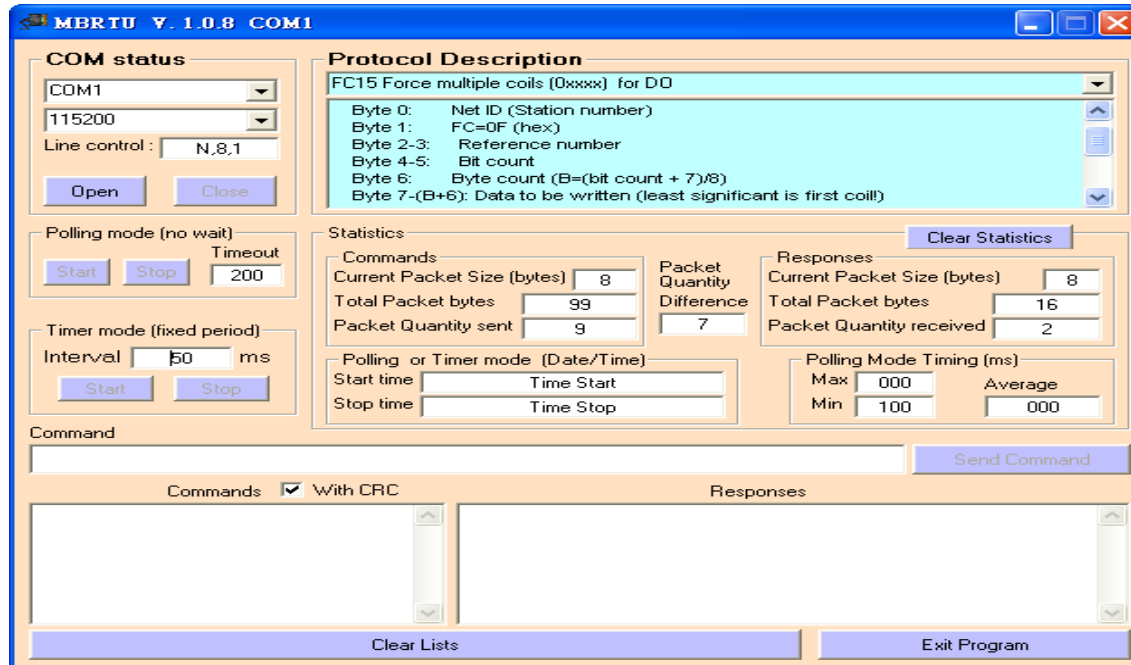

2. Click "Send Command" button to write DO value (0x0102, )

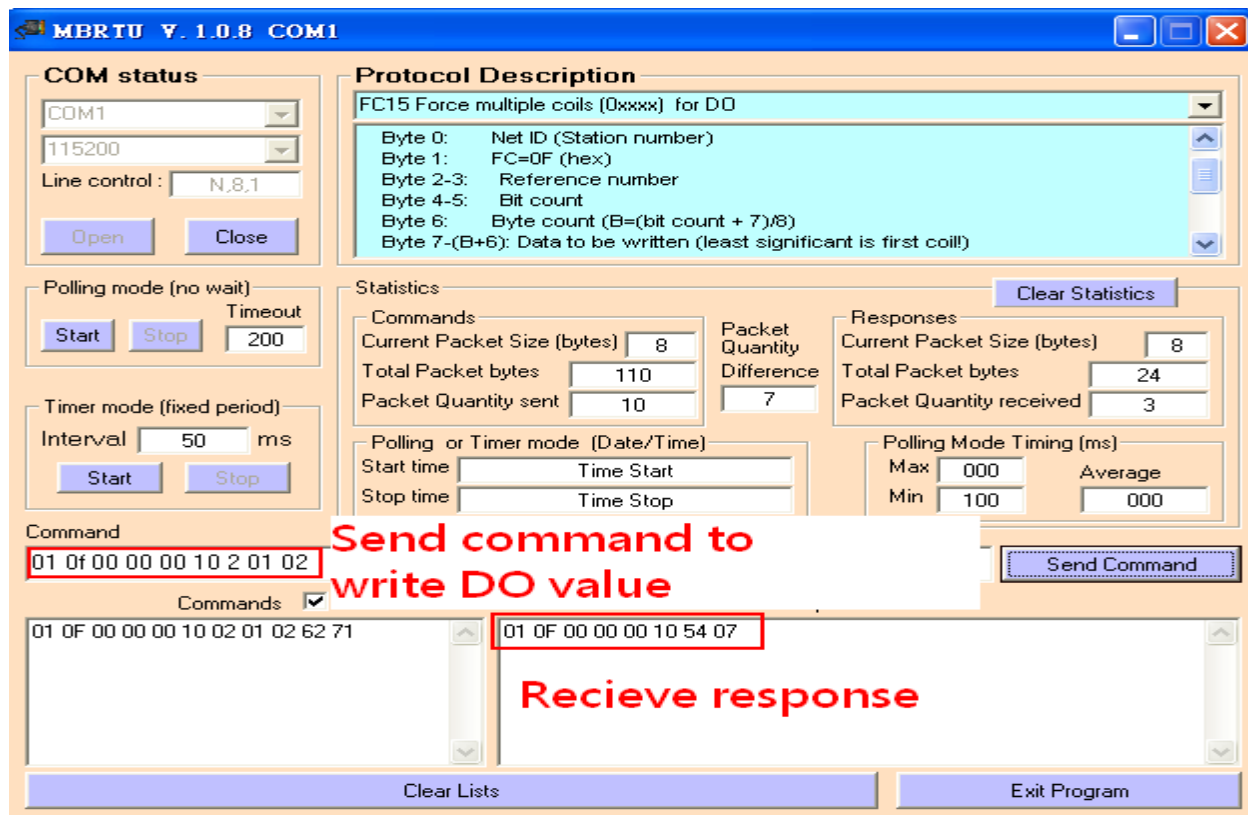

3. PLC will receives the “DO Value (0x01, 0x02)” at PLC address IB0&IB1

**Network 1**: Title:

Comment:

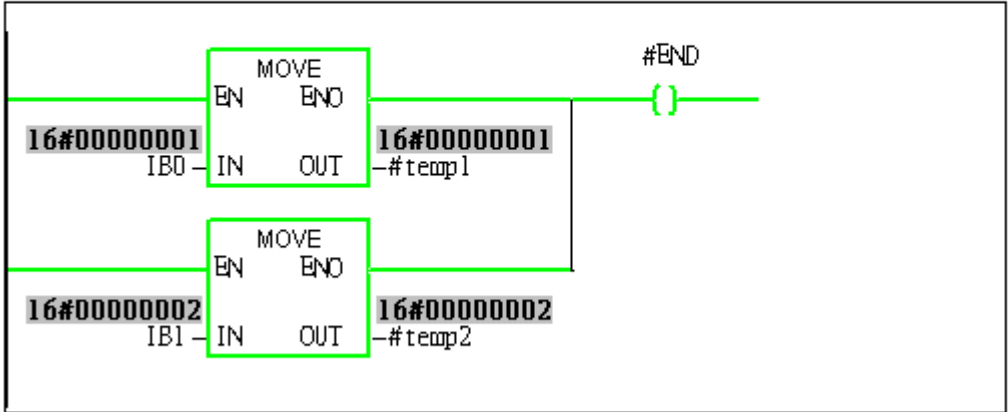



## Example 3: PLC refreshes DI data to Modbus master.

### SIMATIC STEP 7 Edit

1.HW Config. – configure GW-7553 (ex: System setting module x1, Output Relay/Coil—2 byte module x1)

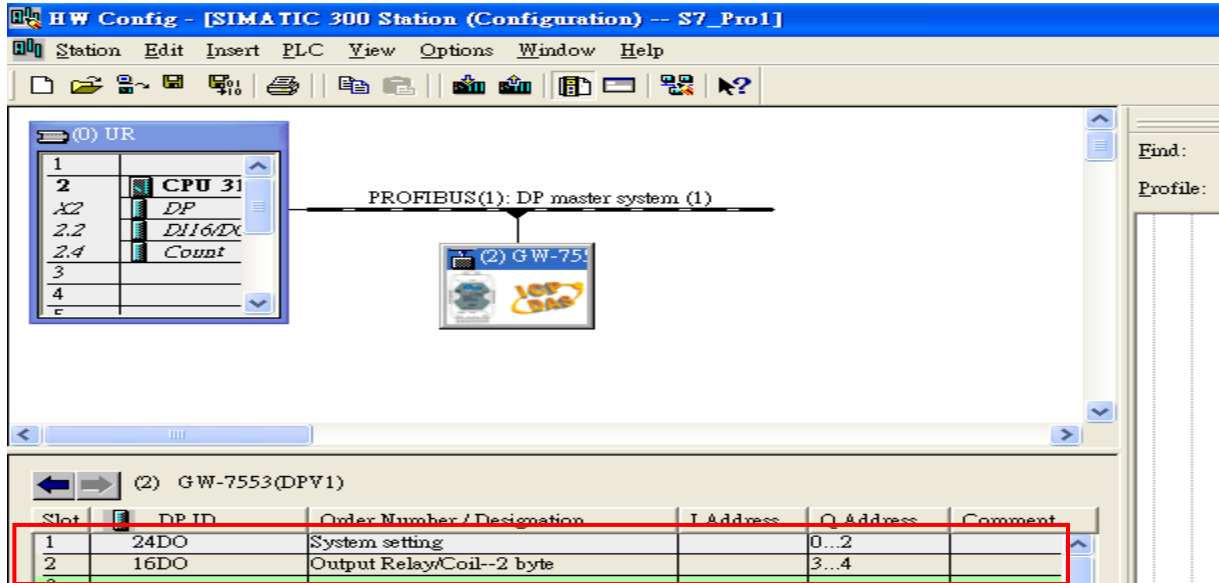

2. HW Config – Parameter assignment (ex: Com port settings, **Modbus type: Slave**, **Modbus format: RTU**, **Byte Order: Big Endian**). Confirm the GW-7553's Com Port setting is the same with MBRTU tool (ex: **baud rate-115200**, **data bits-8**, **stop bits-1**, **parity-none**). About the MBRTU tool, please refer to the “Communication test” in the below.

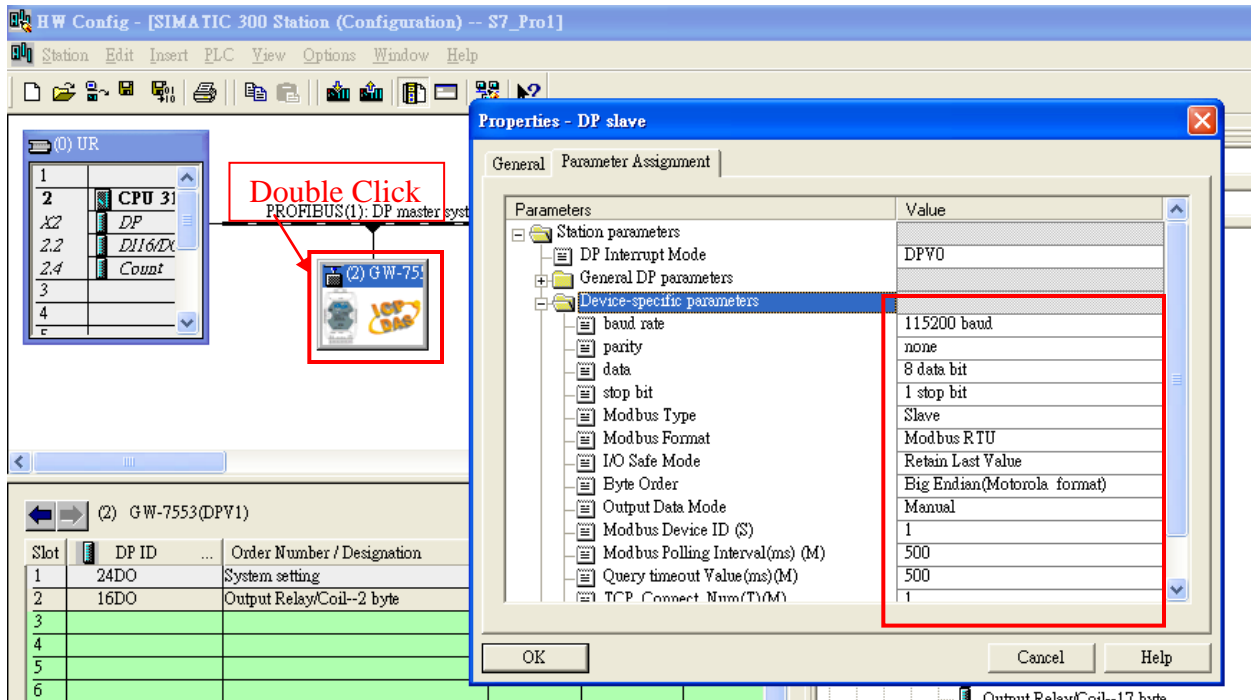

### 3. Save and Compile

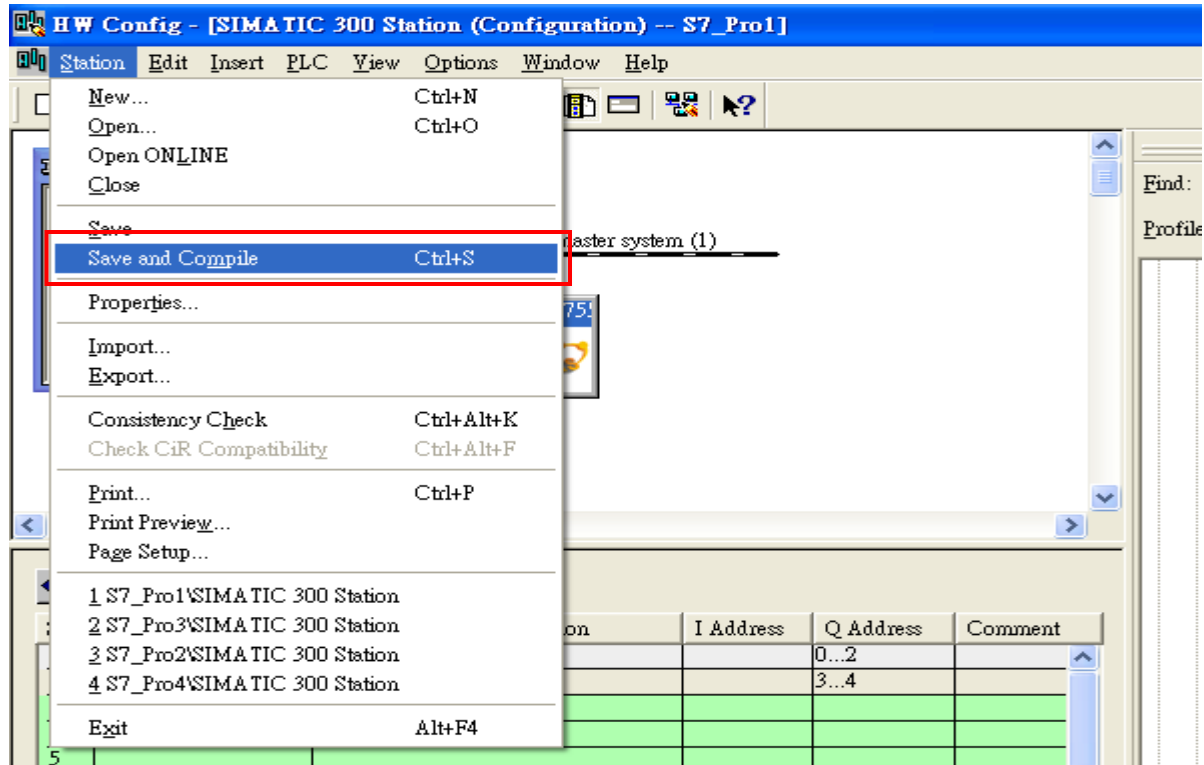

### 4. Download setting into STEP 7

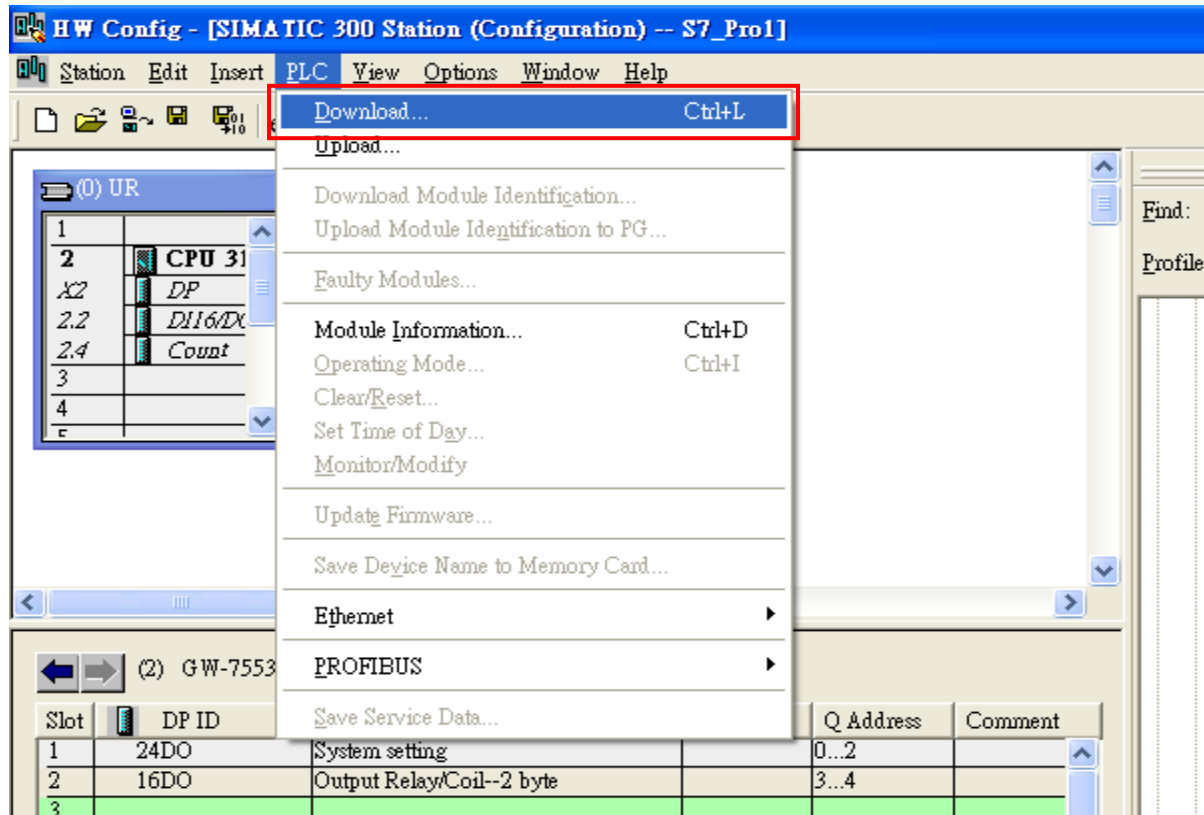

5. Insert a new Organization Block (OB1,OB82,OB86)

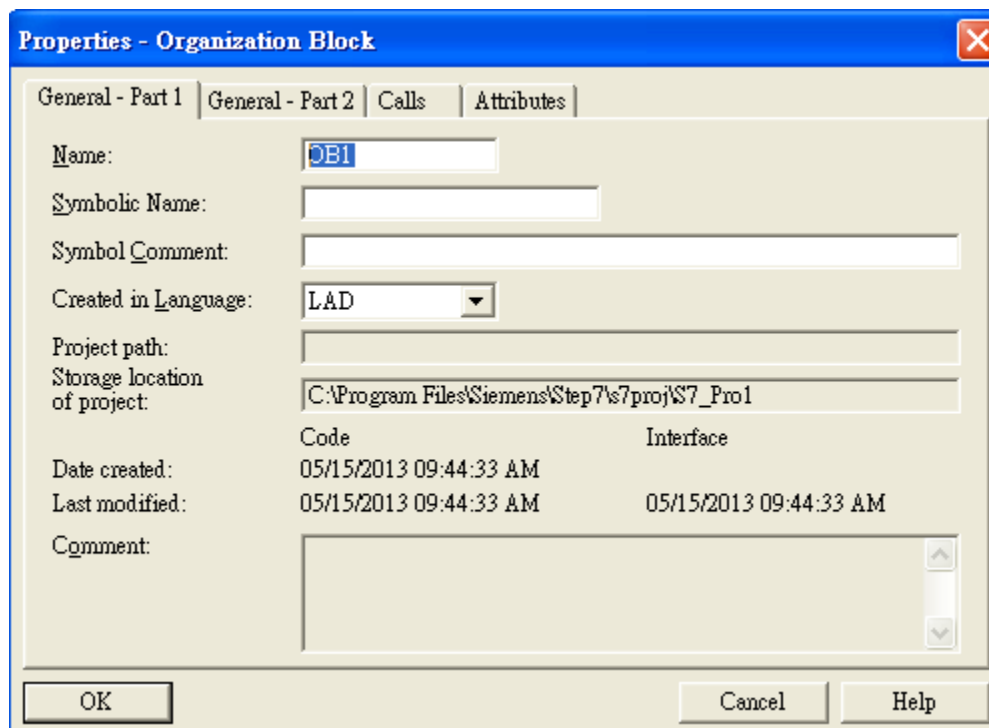
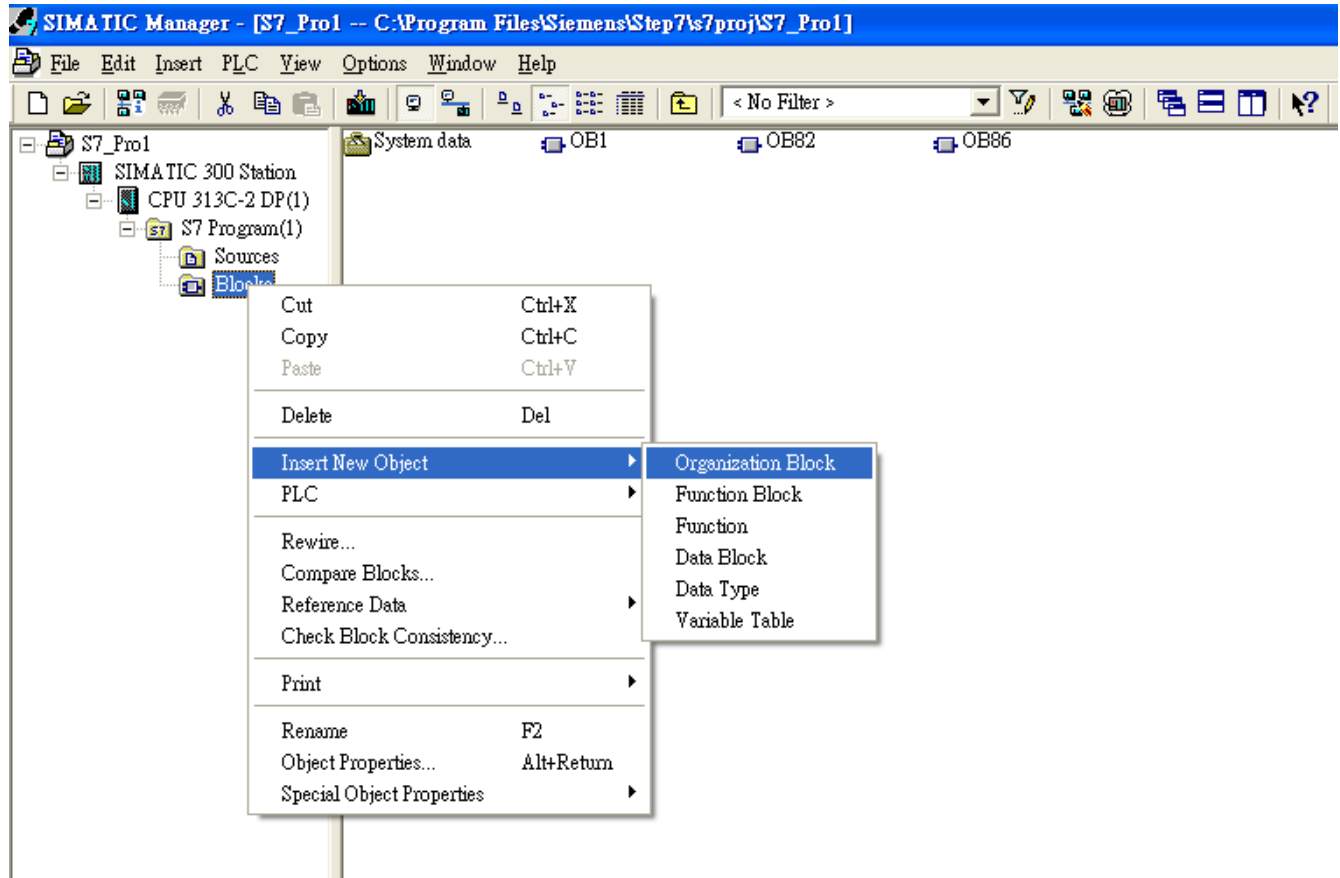

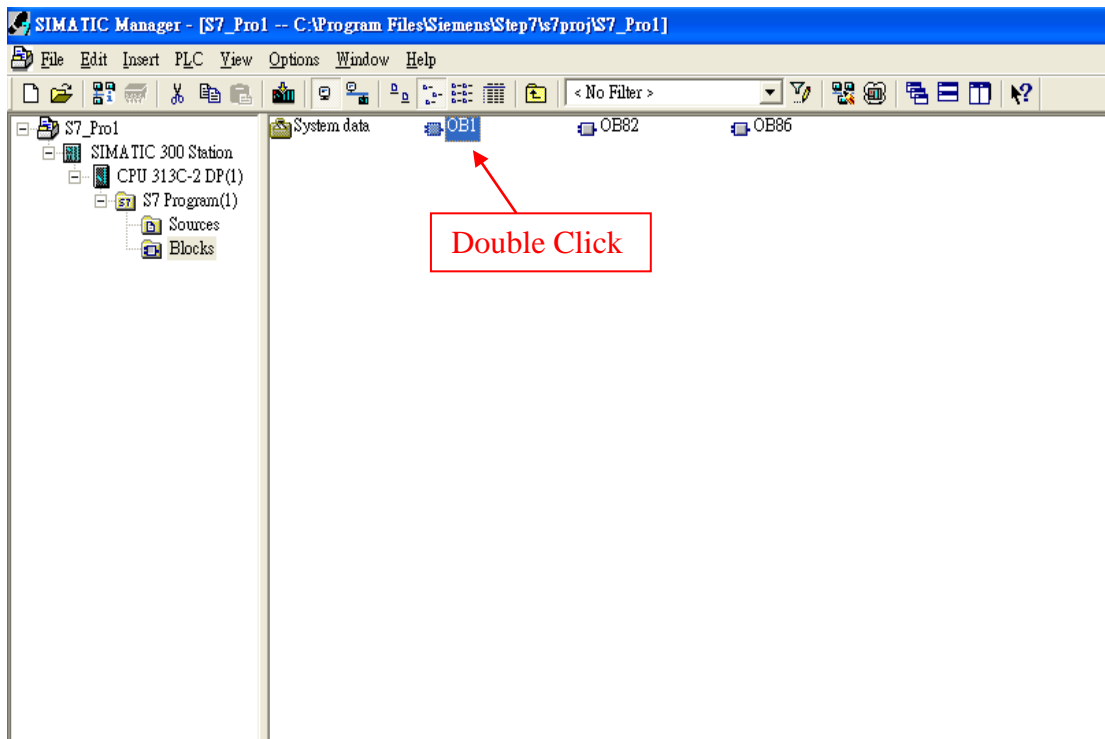

## 6.S7 program edit

Variables used in the example LD Program:

Name	Data Type	Address	Comment
OB1_MAX...	Int	10.0	Maximum cycle time of OB1 (milliseconds)
OB1_DAT...	Date_...	12.0	Date and time OB1 started
END	Bool	20.0	
Init	Bool	20.1	
tri	Int	22.0	

**Network 2**: Initial Cl

Initial Cl

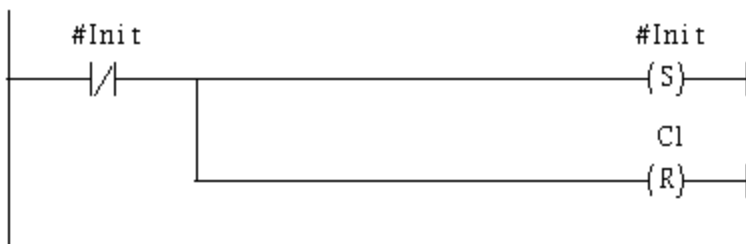

OBI : "Main Program Sweep (Cycle)"

PROFIBUS slave  
Modbus slave

**Network 1**: QB0 add "1" refresh DO value

2 byte 16 DO

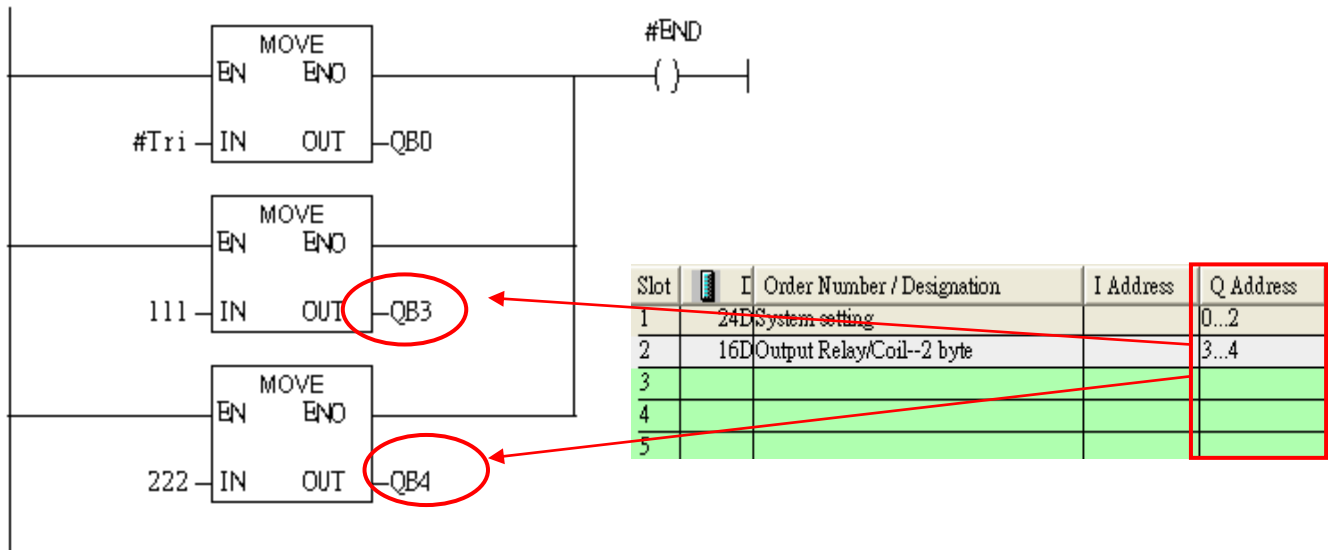

Using T2 trigger T1 .C1 and Tri will add 1 every 1s.

**Network 2** : Timer T1 & T2

Using T2 triggler T1

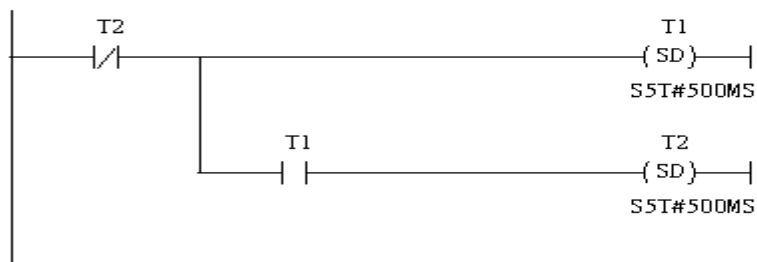

**Network 3** : T1 triggler Counter(C1)

Counter(C1) add "1" and Tri add "1" , too.

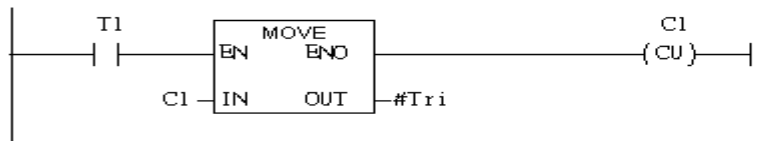

If Tri is equal to 256, reset counter (C1)

**Network 4** : Compare Tri with 256

If Tri is equal to 256 that will reset C1.

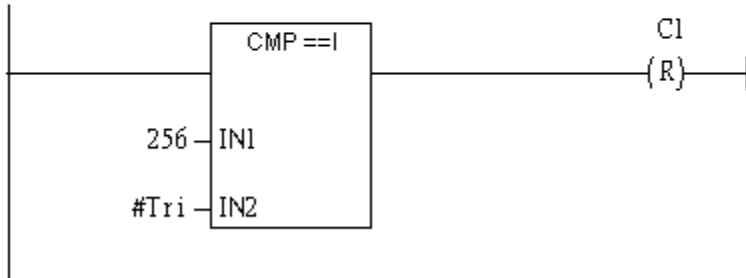

## 7. S7 program download

The screenshot shows the SIMATIC Manager interface. The 'Download' menu is open, listing options such as 'Select Online CPU...', 'Establish Connection to Configured CPU', 'CPU Messages...', 'Display Force Values', 'Monitor/Modify Variables', 'Module Information...', 'Operating Mode...', 'Clear/Reset...', and 'Set Time of Day...'. Below the menu, a table displays variable declarations:

Name	Data Type	Address	Comment
Obl_MAX...	Int	10.0	Maximum cycle time c
Obl_DAT...	Date_...	12.0	Date and time Obl s
END	Bool	20.0	
Init	Bool	20.1	
tri	Int	22.0	

Below the table, the main program window shows 'OB1 : "Main Program Sweep (Cycle)"'. Underneath, there is a 'Network 1' with a normally open contact labeled '#Init' and a coil labeled '#Init (S)', representing a set instruction for the variable #Init.

8. Make sure the RUN LED of the GW-7553 is on and the switch of the GW-7553 is at Normal mode.



### Communication test

1. Confirm the Com Port setting of Modbus Master tool is the same with GW-7553's (ex: MBRTU, you can download MBRTU from [http://ftp.icpdas.com.tw/pub/cd/8000cd/napdos/modbus/modbus\\_utility/](http://ftp.icpdas.com.tw/pub/cd/8000cd/napdos/modbus/modbus_utility/))

Com Port Settings: baud rate-115200, data bits-8, stop bits-1, parity-none

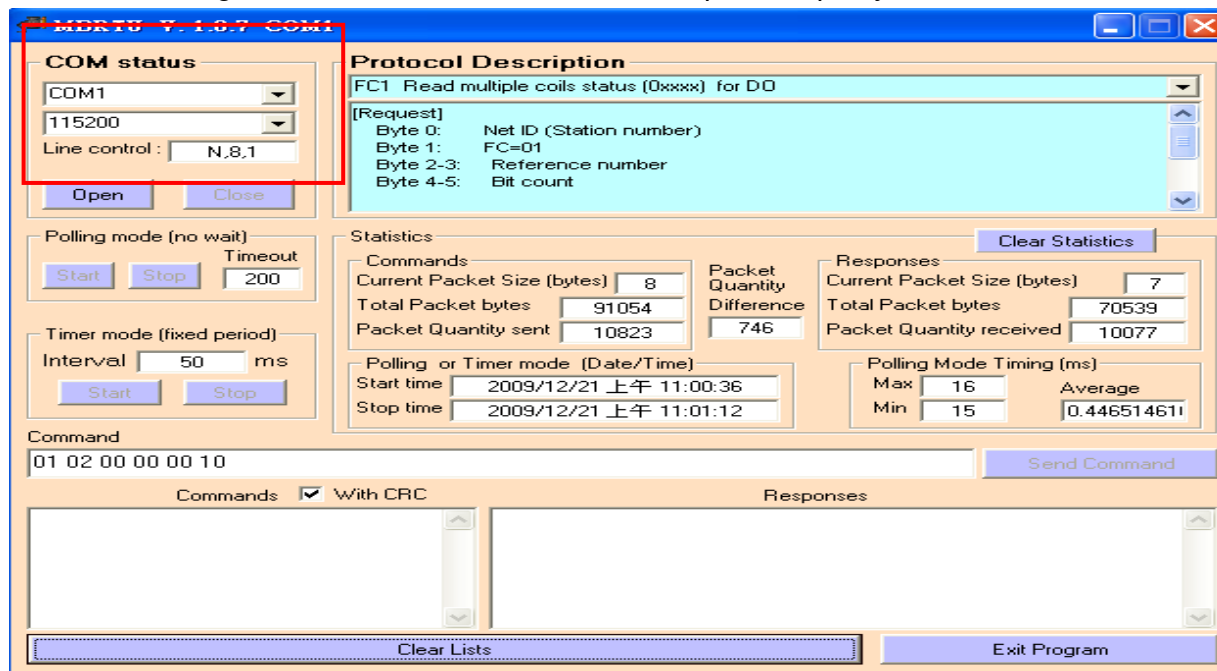

2. Input command (" 01 02 00 00 00 10") in MBRTU and click <Send Command> button to send Modbus command: "01 02 00 00 00 10 79 C6". We can get the DI value (0x6F, 0xDE) from the response message.

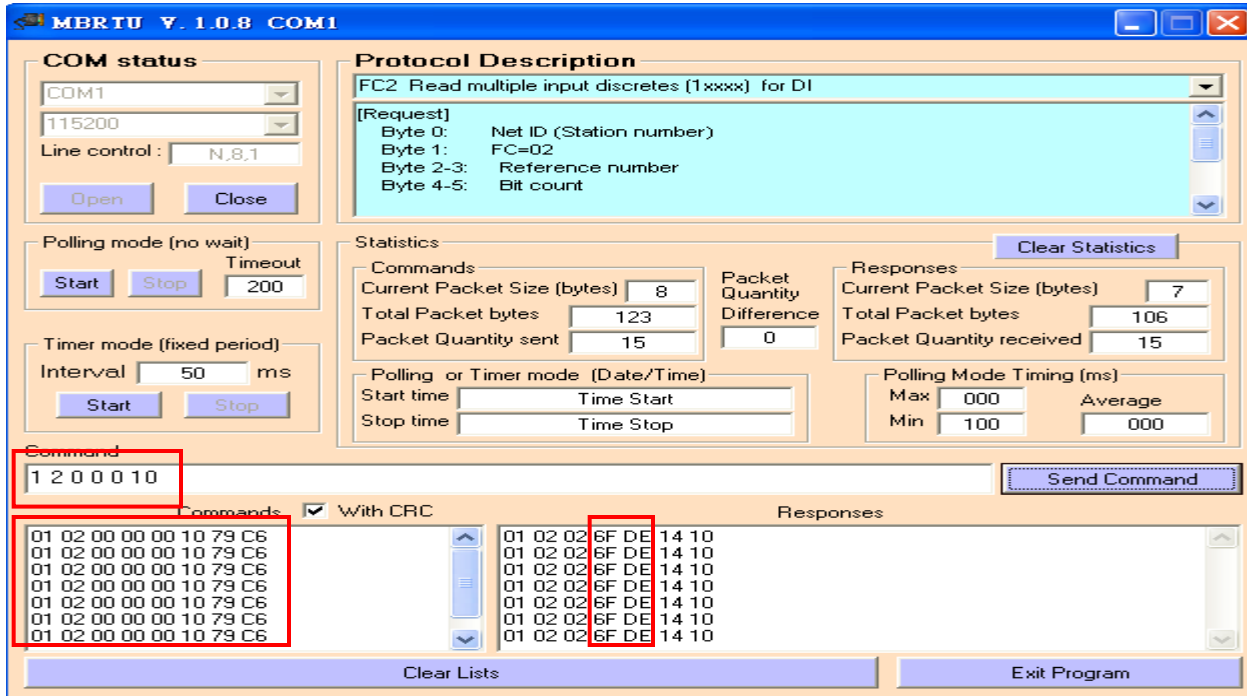

3. We change QB3 to 0xFF and QB4 to 0xFF, and then we can click <Send Command> button to read DI again at MBRTU and we will get the new DI value (0xFF, 0xFF) from the response message.

**Network 2**: Title:

Comment:

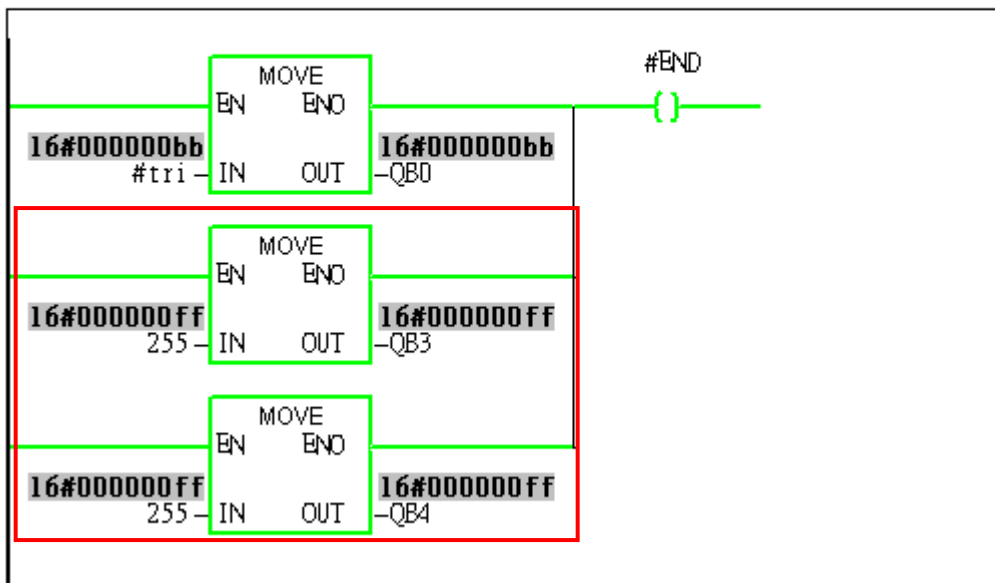



**MBRTU V. 1.0.8 COM1**

**COM status**

COM1

115200

Line control: N,8,1

Open Close

**Protocol Description**

FC2 Read multiple input discretes (1xxxx) for DI

[Request]

Byte 0: Net ID (Station number)

Byte 1: FC=02

Byte 2-3: Reference number

Byte 4-5: Bit count

**Polling mode (no wait)**

Start Stop Timeout 200

**Statistics** Clear Statistics

Commands		Packet Quantity	Responses	
Current Packet Size (bytes)	8	Difference	Current Packet Size (bytes)	7
Total Packet bytes	179		Total Packet bytes	155
Packet Quantity sent	22		Packet Quantity received	22

**Timer mode (fixed period)**

Interval 50 ms

Start Stop

**Command**

1 2 0 0 1 0 Send Command

Commands  With CRC

```

01 02 00 00 00 10 79 C6
01 02 00 00 00 10 79 C6
01 02 00 00 00 10 79 C6
01 02 00 00 00 10 79 C6
01 02 00 00 00 10 79 C6
01 02 00 00 00 10 79 C6
01 02 00 00 00 10 79 C6
01 02 00 00 00 10 79 C6

```

Responses

```

01 02 02 FF FF 88 08
01 02 02 FF FF 88 08
01 02 02 FF FF 88 08
01 02 02 FF FF 88 08
01 02 02 FF FF 88 08
01 02 02 FF FF 88 08
01 02 02 FF FF 88 08
01 02 02 FF FF 88 08

```

Clear Lists

Exit Program

## Example 4: PLC refreshes AI data to Modbus master.

### SIMATIC STEP 7 Edit

1.HW Config. – configure GW-7553 (ex: System setting module x1, Output Register—2 word module x1)

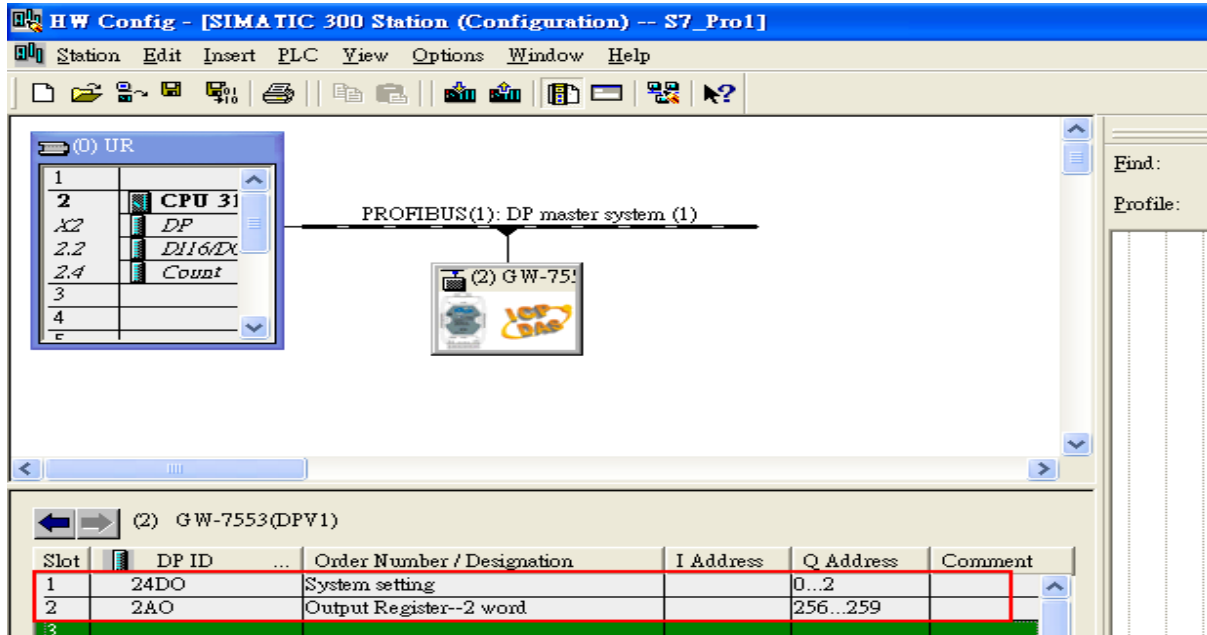

2. HW Config – Parameter assignment (ex: Com port settings, **Modbus type: Slave**, **Modbus format: RTU**, **Byte Order: Big Endian**). Confirm the GW-7553's Com Port setting is the same with MBRTU tool (ex: **baud rate-115200**, **data bits-8**, **stop bits-1**, **parity-none**). About the MBRTU tool, please refer to the “Communication test” in the below.

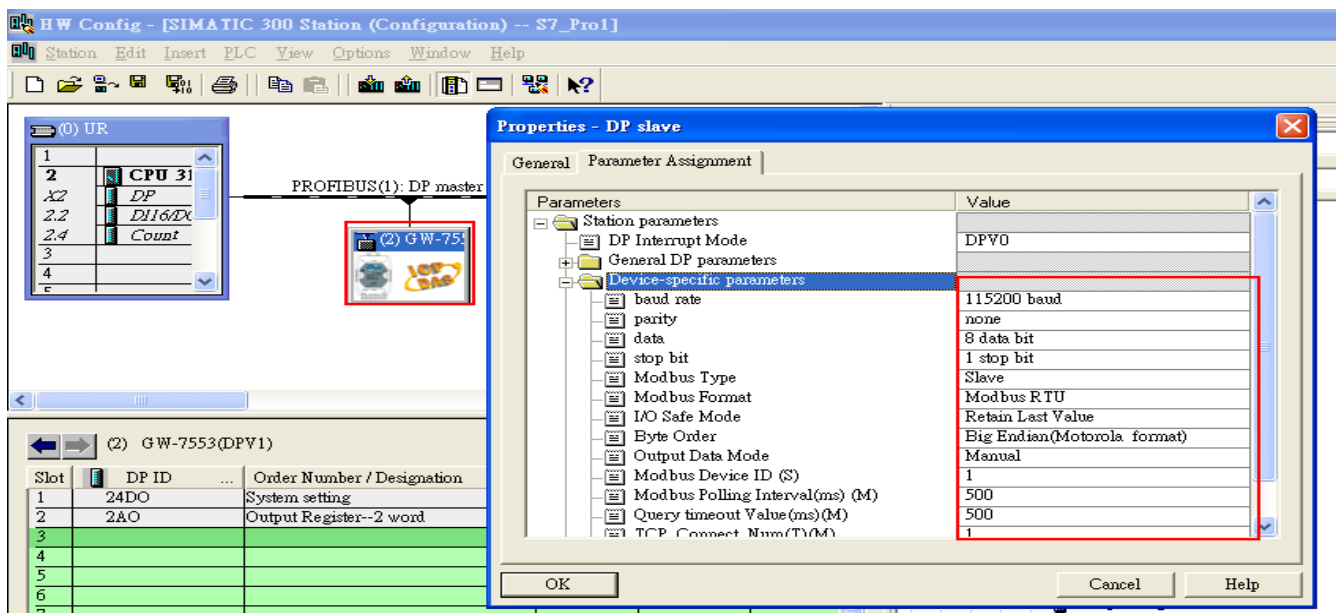

### 3. Save and Compile

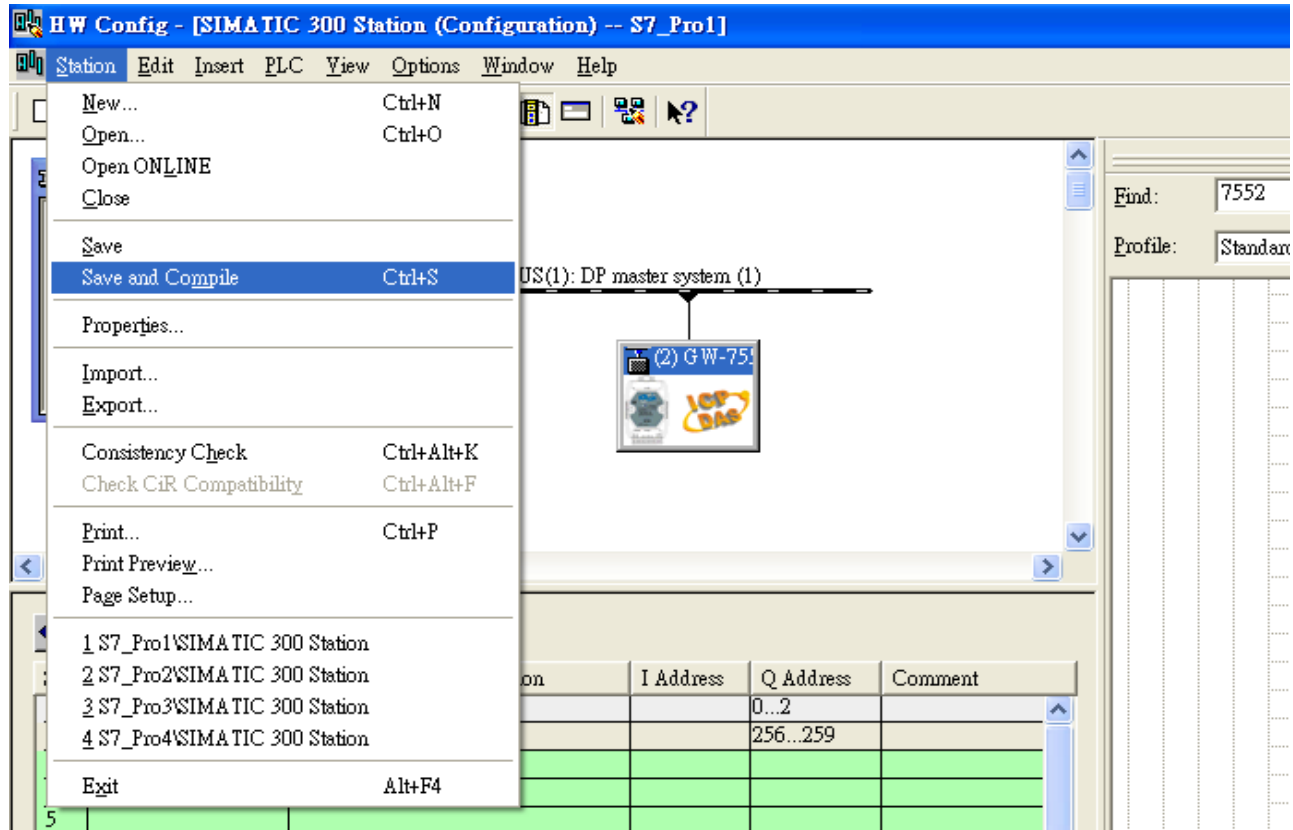

### 4. Download setting into STEP 7

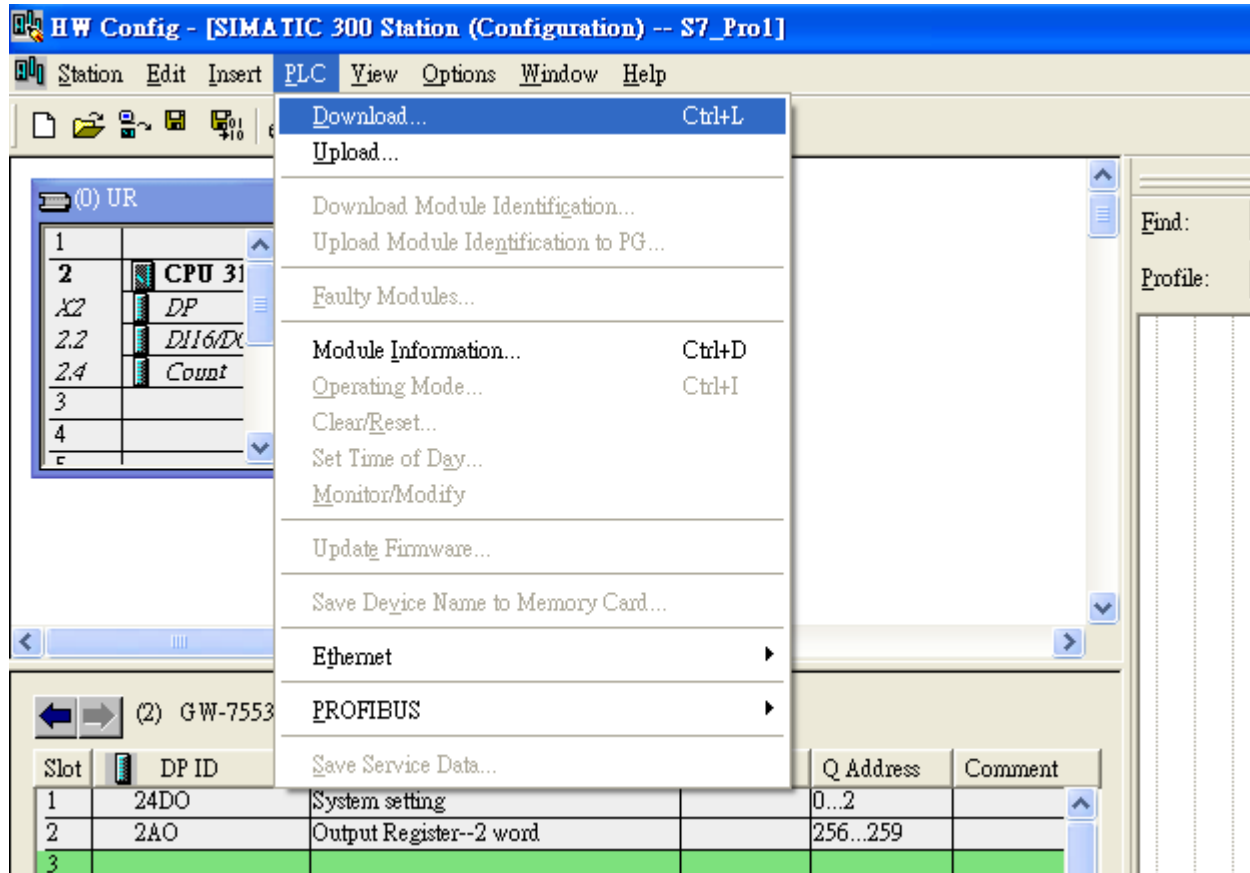

5. Insert a new Organization Block (OB1,OB82,OB86)

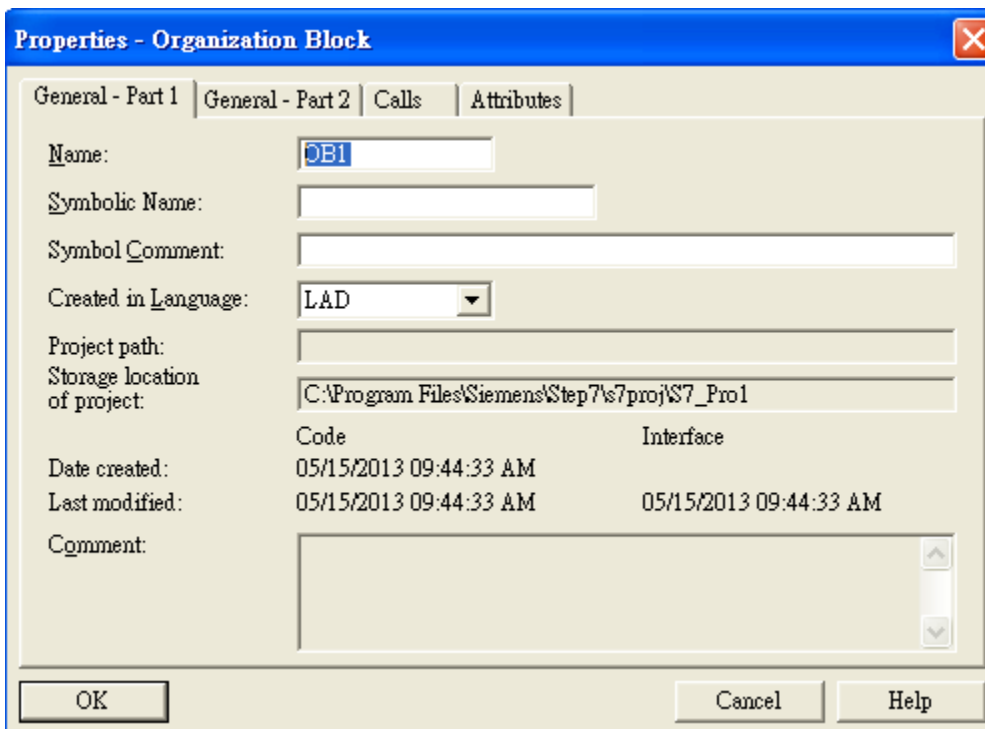
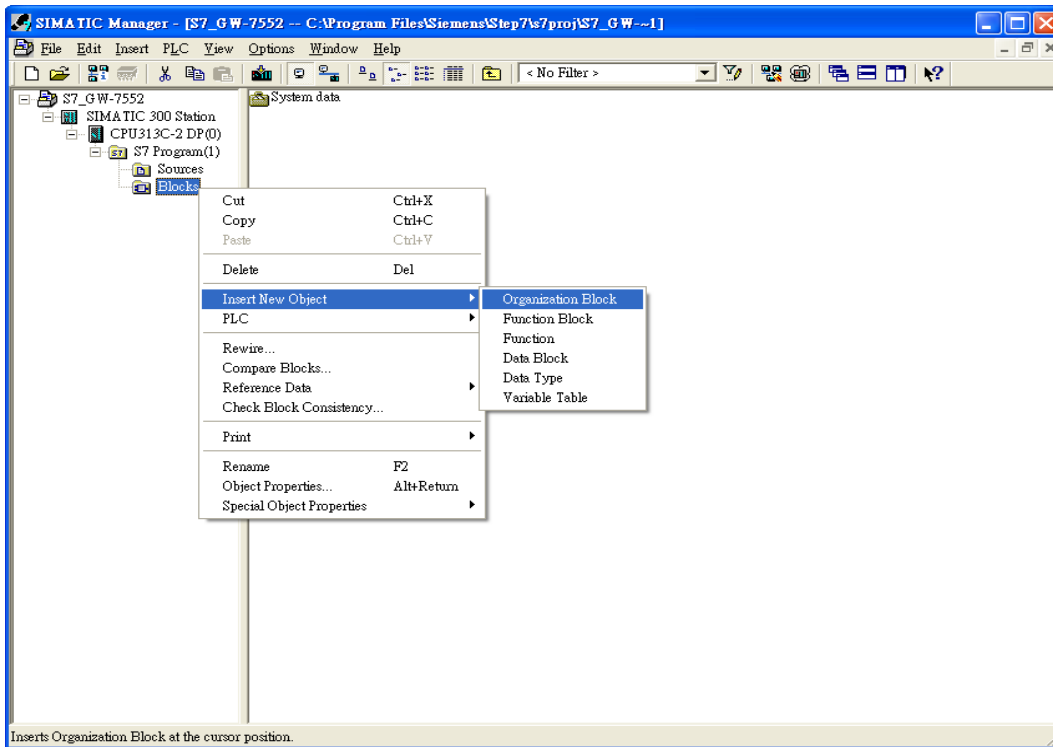

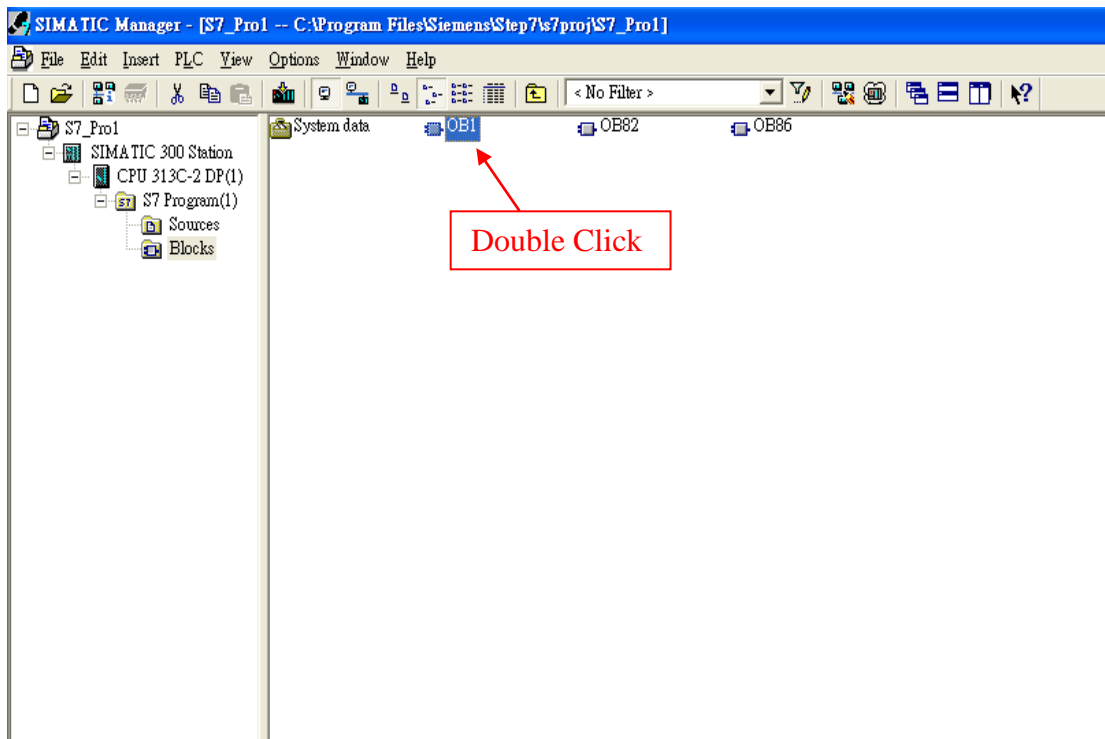

## 6.S7 program edit

Variables used in the example LD Program:

Name	Data Type	Address	Comment
OB1_DAT...	Date_...	12.0	Date and time OB1 started
END	Bool	20.0	
Tri	Int	22.0	
Init	Bool	24.0	

### Network 1 : Initial Cl

Initial Cl

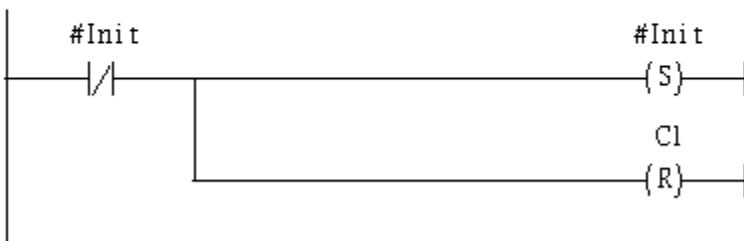

**Network 2 :** QBD add "1" refresh AO value

2 word 2AO

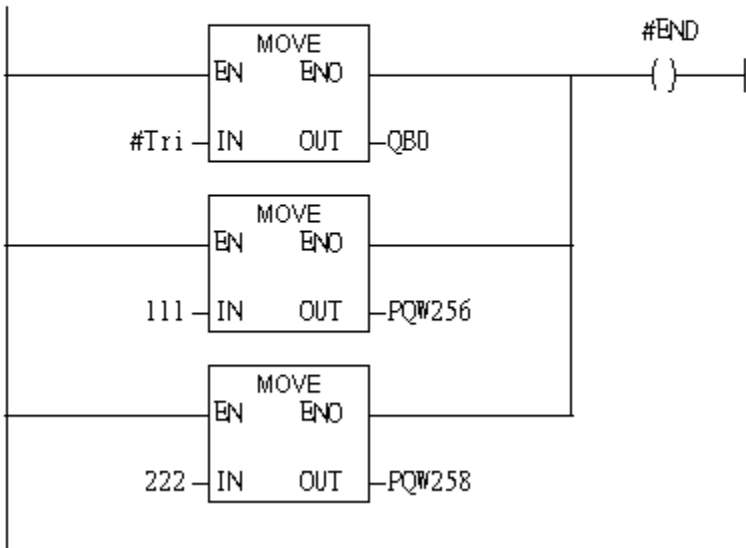

**Network 3 :** Timer T1 & T2

Using T2 trigger T1

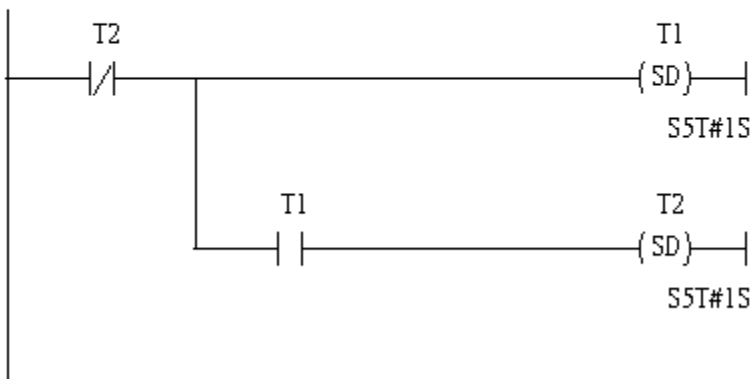

### Network 4 : T1 trigger C1

Counter(C1) add "1" and Tri add "1" ,too.

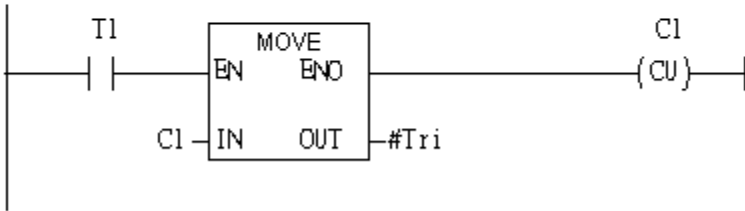

### Network 5 : Compare Tri with 256

If Tri is equal to 256 than will reset C1.

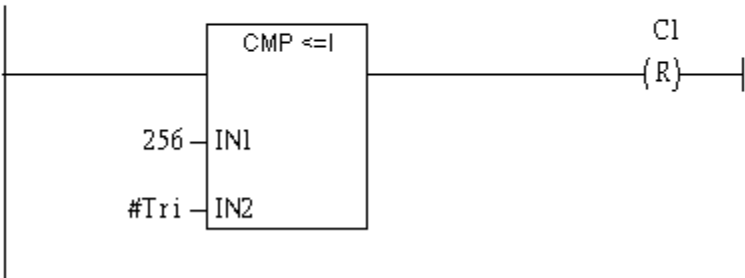

## 7. S7 program download

The screenshot shows the SIMATIC Manager interface. The 'Download' menu is open, displaying options such as 'Select Online CPU...', 'Establish Connection to Configured CPU', 'CPU Messages...', 'Display Force Values', 'Monitor/Modify Variables', 'Module Information...', 'Operating Mode...', 'Clear/Reset...', and 'Set Time of Day...'. In the background, a variable declaration table is visible:

Name	Data Type	Address	Comment
OBI_DAT...	Date_...	12.0	Date and time OBI sta
END	Bool	20.0	
Tri	Int	22.0	
Init	Bool	24.0	

Below the screenshot, the 'Network 5' diagram is repeated, showing the 'CMP <=>' instruction with '256' and '#Tri' as inputs and 'C1 (R)' as the output.

8. Make sure the RUN LED of the GW-7553 is on and the switch of the GW-7553 is at Normal mode.



### Communication test

1. Confirm the Com Port setting of Modbus Master tool is the same with GW-7553's (ex: MBRTU, you can download MBRTU from [http://ftp.icpdas.com.tw/pub/cd/8000cd/napdos/modbus/modbus\\_utility/](http://ftp.icpdas.com.tw/pub/cd/8000cd/napdos/modbus/modbus_utility/))

Com Port Settings: baud rate-115200, data bits-8, stop bits-1, parity-none

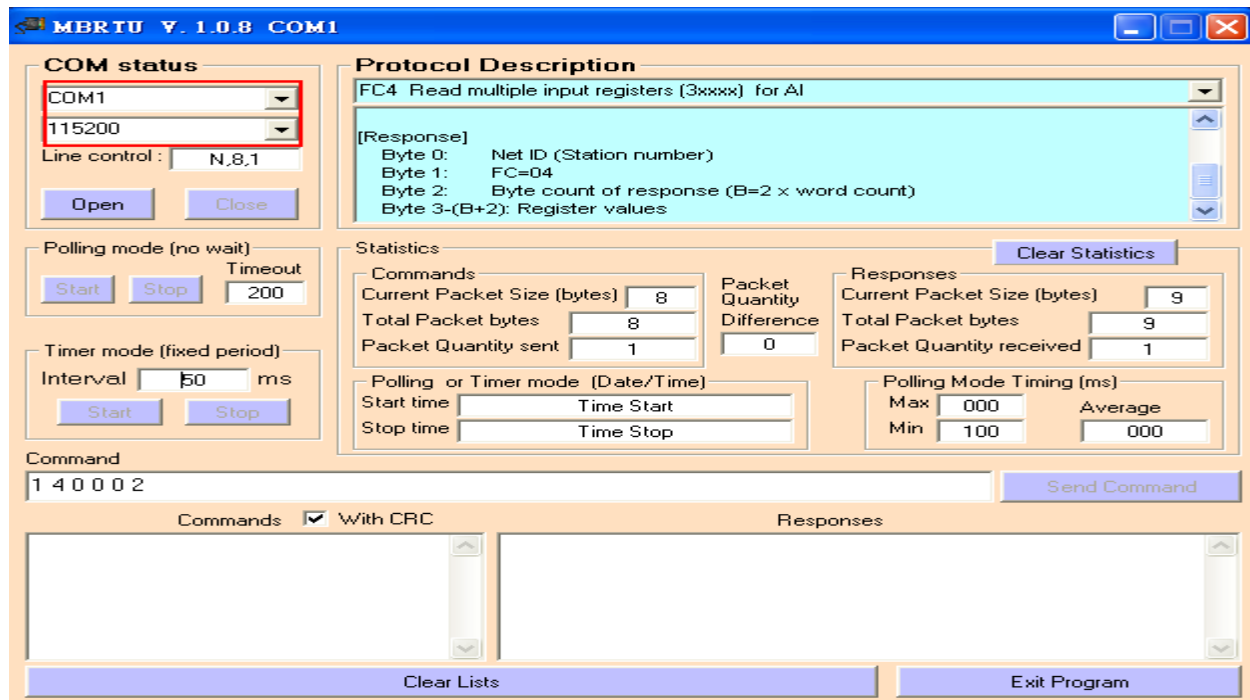



2. Input command (" 01 04 00 00 00 02") in MBRTU and click <Send Command> button to send Modbus command: "01 04 00 00 00 02 71 CB". We can get the AI value (0x006F, 0x00DE) from the response message.

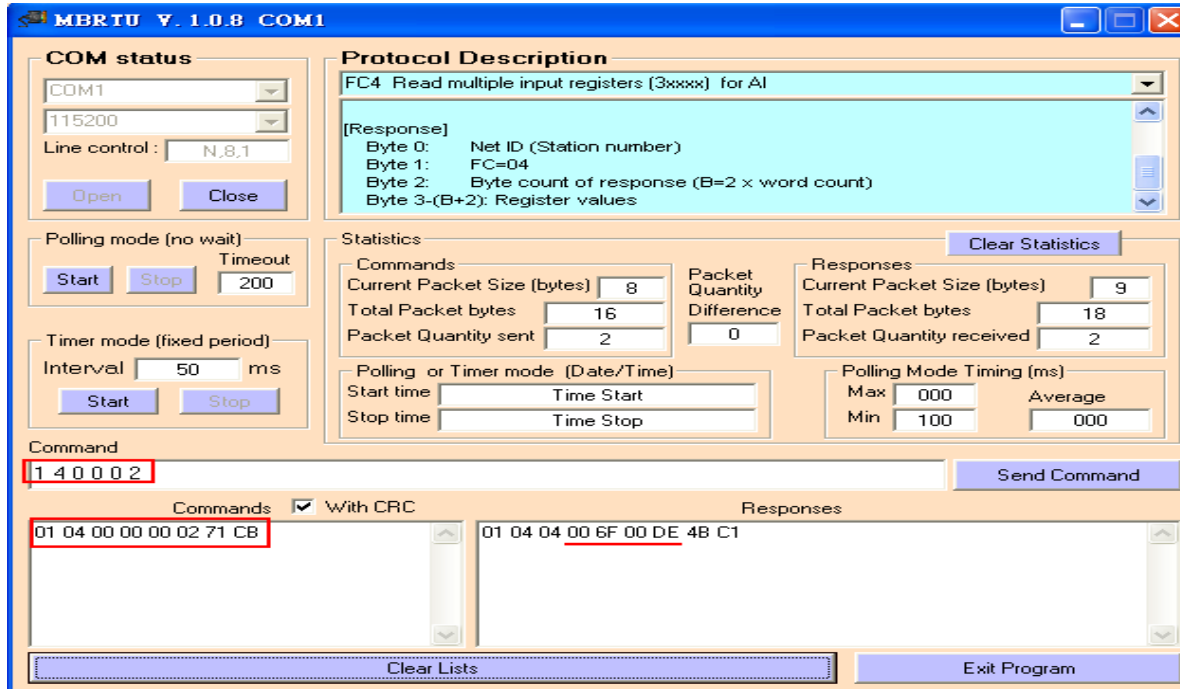

3. We change PQW256 to 0x00FE and PQW258 to 0x00DC, and then we can click <Send Command> button to read AI again at MBRTU and we will get the new AI value (0x00FE, 0x00DC) from the response message.

**Network 2:** QBD add "1" refresh AO value

2 word 2AO

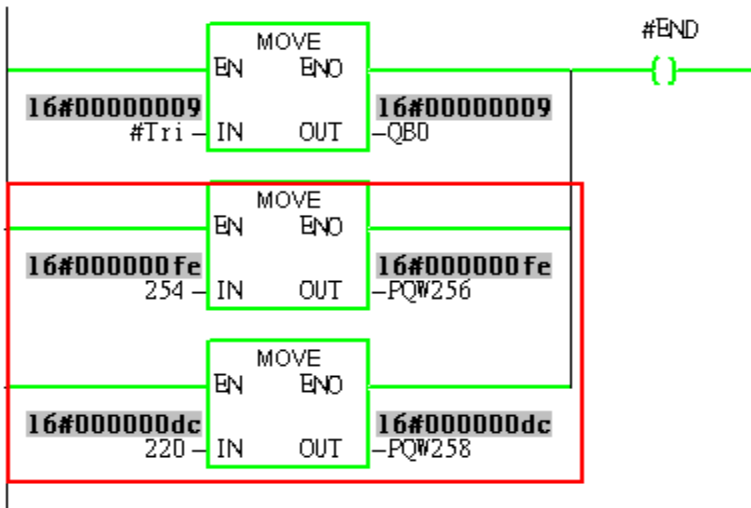

**MBRTU V. 1.0.8 COM1**

**COM status**

COM1

115200

Line control: N,8,1

Open Close

**Protocol Description**

FC4 Read multiple input registers (3xxxx) for AI

[Response]

Byte 0: Net ID (Station number)  
 Byte 1: FC=04  
 Byte 2: Byte count of response (B=2 x word count)  
 Byte 3-(B+2): Register values

**Polling mode (no wait)**

Start Stop Timeout 200

**Statistics** Clear Statistics

Commands		Packet Quantity		Responses	
Current Packet Size (bytes)	8	Current Packet Size (bytes)	9	Current Packet Size (bytes)	9
Total Packet bytes	80	Total Packet bytes	90	Total Packet bytes	90
Packet Quantity sent	10	Packet Quantity Difference	0	Packet Quantity received	10

**Timer mode (fixed period)**

Interval 50 ms

Start Stop

**Command**

1 4 0 0 2 Send Command

Commands  With CRC

```
01 04 00 00 00 02 71 CB
01 04 00 00 00 02 71 CB
01 04 00 00 00 02 71 CB
01 04 00 00 00 02 71 CB
```

Responses

```
01 04 04 00 FE 00 DC 9B ED
01 04 04 00 FE 00 DC 9B ED
01 04 04 00 FE 00 DC 9B ED
01 04 04 00 FE 00 DC 9B ED
```

Clear Lists

Exit Program