



NSM-208-M12/NSM-208PSE-M12

EN50155 8-port M12 Unmanaged Ethernet Switch

Features

- Each port supports both 10/100 Mbps speed auto negotiation
- 8 PoE ports with Power Sourcing Equipment (PSE) operation (NSM-208PSE-M12)
- Over-temperature, over-current and over/under-voltage detection (NSM-208PSE-M12)
- 8-port 10/100 Mbps M12 type connector with IP40 protection
- EN50155/50121-3-2/50121-4, and NEMA TS2 compliant
- Automatic MDI/MDI-X crossover for plug-and-play
- Store-and-forward architecture
- Auto-detection of PD (powered devices) and automatic power management (NSM-208PSE-M12)



Introduction

The NSM-208PSE-M12/NSM-208-M12 is designed for industrial applications in harsh environments. The M12 connectors ensure tight, robust connections, and guarantees reliable operation, even for applications that are subject to high vibration and shock.

The NSM-208PSE-M12 PoE switch provides 8 fast Ethernet M12 ports with 8 IEEE 802.3af compliant PoE ports. The switch is classified as power source equipment (PSE) and provide up to 15.4 W of power per port.

The Ethernet switch supports IEEE 802.3/802.3u/802/3x with 10/100M, full/half-duplex, MDI/MDI-X auto-sensing, and provides an economical solution for your industrial Ethernet network.

The NSM-208-M12 provides a wide +12 VDC ~ +53 VDC power range to fit all the common power standards found in industrial automation, without external power converters. The wide power input lowers installation and maintenance costs.

Comparison Table of 8-port M12/IP67 Ethernet Switch

Mode Name	NSM-208PSE-M12	NSM-208-M12	NS-208PSE-IP67	NS-208-IP67
PoE	802.3af x 8	–	802.3af x 8	–
Input Voltage Range	+46 VDC ~ +53 VDC	+12 VDC ~ +53 VDC	+46 VDC ~ +53 VDC	+12 VDC ~ +53 VDC
Operating Temperature	-40 °C ~ +75 °C		-10 °C ~ +60 °C	
Casing	Metal with IP40		Plastic (Flammability UL 94V-0) with IP67	
Installation	Wall Mounting		DIN-Rail Mounting or Wall Mounting	
Dimensions (W x L x H)	190 mm x 100 mm x 56 mm		190 mm x 155 mm x 104 mm	

Specifications

Model	NSM-208-M12	NSM-208PSE-M12
LED Indicators		
Status	PWR, Link/Act	PWR, Link/Act, Power Device is detected
Ethernet		
Ports	8 x M12 connector, 10/100Base-TX	
Standards	IEEE 802.3, 802.3u, 802.3x, 10/100 Base-T(X) auto negotiation speed, F/H duplex mode, and auto MDI/MDI-X connection	
Processing Type	Store & forward	
MAC Table	1024	
Memory Bandwidth	3.2 Gbps	
Frame Buffer Memory	512 Kbit	
Flow Control	IEEE 802.3x flow control, back pressure flow control	
Isolation	1500 Vrms 1 minute	
Connector	Female 4-Pin shielded M12 D-coding connector	
PoE Technology		
PoE Compliance	-	100% IEEE 802.3at compliant
PoE Power	-	Up to 30 watts per channel
PoE Operation	-	Automatic detection and power management
PoE Pin Assignments	-	V+ (pin 1, 2), V-(pin 3, 6)
PoE Disconnect Mode	-	DC disconnect
PoE Voltage	-	+52 VDC
Power		
Reverse Polarity Protection	Yes	
Input Range	+12 VDC ~ +53 VDC	+46 VDC ~ +53 VDC
Consumption	0.12 A @ 48 VDC	0.12 A @ 48 VDC without PD loading 3.0 A @ 48 VDC with PD full loading
Mechanical		
Casing	Metal	
Dimensions (mm)	190 x 100 x 56 (W x L x H)	
Installation	Wall Mounting	
Ingress Protection Rating	IP40	
Environment		
Operating Temperature	-40 °C ~ +75 °C	
Storage Temperature	-40 °C ~ +85 °C	
Humidity	10% ~ 90% RH, non-condensing	

Applications

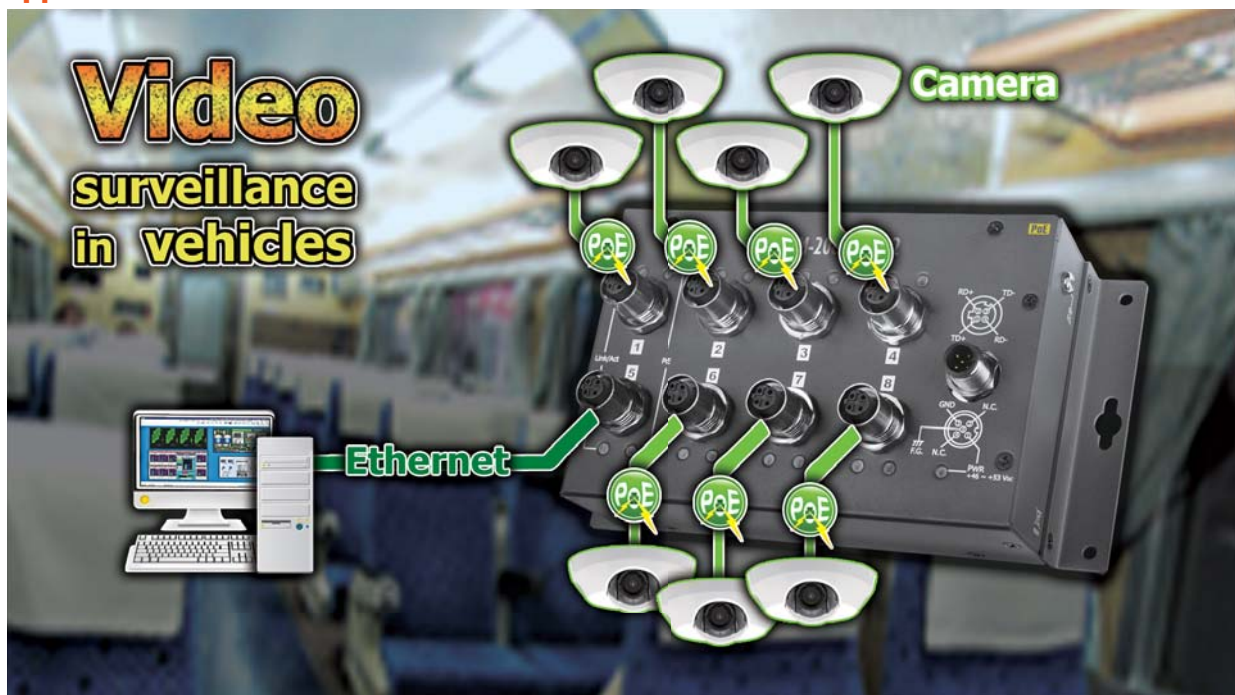

EN50155 8-port M12 Unmanaged Ethernet Switch

- NSM-208-M12
 - NSM-208PSE-M12
- 



Wide Range Temperature: $-40\text{ }^{\circ}\text{C} \sim +75\text{ }^{\circ}\text{C}$
EN50155-certified for harsh railway standard



Appearance

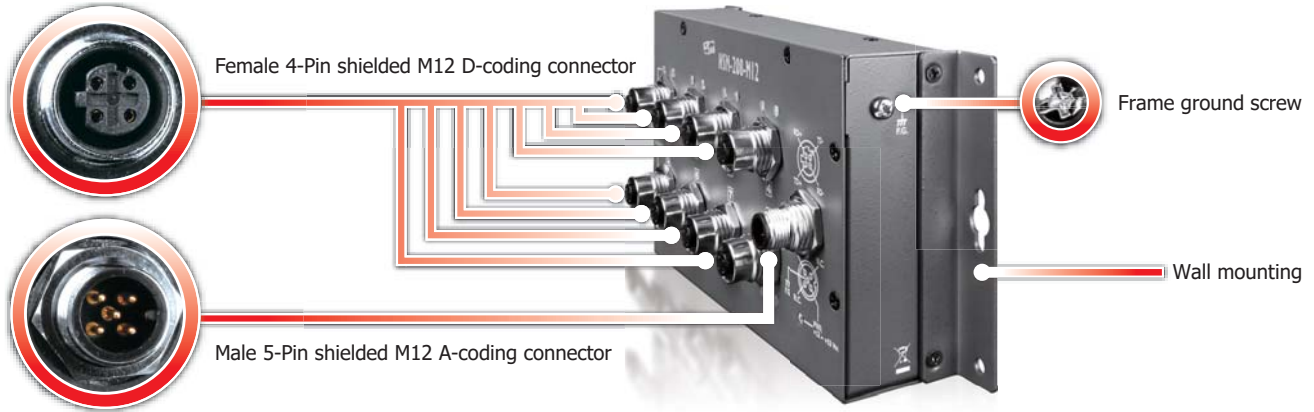

Pin Functions for Power Input

External power supply is connected using the M12 A-coding:

PWR: Power input and should be connected to the power supply (+)

GND: Ground and should be connected to the power supply (-)

F.G.: F.G. stands for Frame Ground (protective ground). It is optional.
If you use this pin, it can reduce EMI radiation; improve EMI performance and EMS protection.

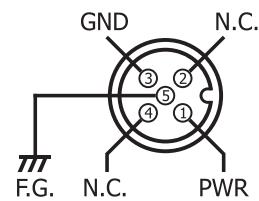

Pin Functions for Ethernet Port

For NSM-208PSE-M12

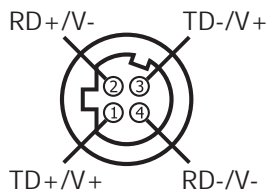

For NSM-208-M12

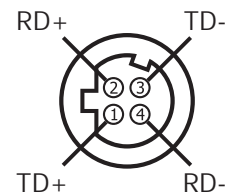

Dimensions (Units: mm)

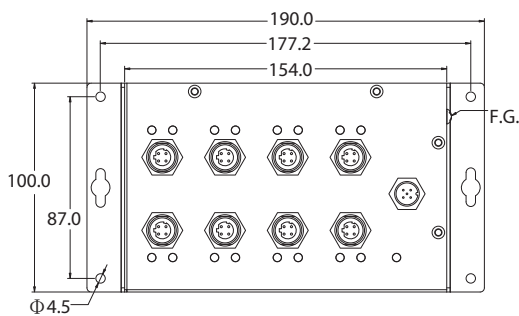

Front View

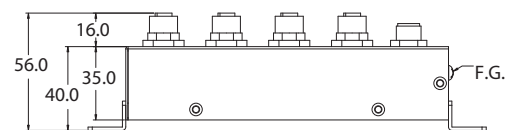

Bottom View

Ordering Information

NSM-208-M12 CR	EN50155 8-port M12 Unmanaged Ethernet Switch (RoHS) Includes M12D-4P-IP68 x 8, A-CAP-M12M x 8, M12A-5P-IP68 x 1, A-CAP-M12F x 1 and 4SIX1K0000003 Wall mount
NSM-208PSE-M12 CR	EN50155 8-port M12 Unmanaged PoE Ethernet Switch (RoHS) Includes M12D-4P-IP68 x 8, A-CAP-M12M x 8, M12A-5P-IP68 x 1, A-CAP-M12F x 1 and 4SIX1K0000003 Wall mount

Accessories

M12D-4P-IP68	A-CAP-M12M	M12A-5P-IP68	A-CAP-M12F
4PIO1K0000001	4PIO1K0000002	4PIO1K0000003	4PIO1K0000004

You need to choose high quality M12 cable, please refer to <https://www.balluff.com/>