

CL-200 Series User Manual

Remote PM2.5/O₂/CO/CO₂/NH₃/H₂S/HCHO/TVOC/

Temperature/Humidity/Dew Point Data Logger Module



Version: 1.3.0

Date: Mar. 2021

Warranty

All products manufactured by ICP DAS are warranted against defective materials for a period of one year from the date of delivery to the original purchaser.



Warning

ICP DAS assumes no liability for damages consequent to the use of this product. If the equipment is used in a manner not specified by the manufacturer, the protection provided by the equipment may be impaired.

ICP DAS reserves the right to change this manual at any time without notice. The information furnished by ICP DAS is believed to be accurate and reliable. However, no responsibility is assumed by ICP DAS for its use, nor for any infringements of patents or other rights of third parties resulting from its use.

Copyright

Copyright © 2017 by ICP DAS. All rights are reserved.

Contact Us

If you have any questions, please feel free to contact us via email at:

Service@icpdas.com

Contents

1. Introduction.....	5
2. Hardware.....	10
2.1 Specifications.....	10
2.2 Appearance.....	34
2.3 Dimensions (unit: mm).....	36
2.4 Cabling for Power and Network.....	37
3. Configuration via Web Browser.....	43
3.1 Search the CL-200 logger.....	43
3.2 Logging into the CL-200.....	44
3.3 Home.....	45
3.4 Network.....	46
3.5 MQTT.....	49
3.6 I/O Settings.....	51
3.7 Filter IP.....	56
3.8 Change Password.....	57
3.9 Logout.....	58
3.10 Wi-Fi.....	59
4. Configuration via RS-485.....	62
5. Configuration via Wi-Fi.....	73
6. Monitoring via Mobile Devices.....	79
7. Utility to Get/Manage Data Log.....	80
8. FAQ.....	91
Q1: What is ABC (Automatic Baseline Correction)?.....	91
Q2: Why I need to enable the ABC?.....	91
Q3: Does the CL-202/CL-212/CL-203/CL-213 enable the ABC as the factory default setting?.....	91
Q4: What to do when the ABC is no work?.....	91
Q5: How to set the Accessible IP?.....	92
Q6: How to delete the Accessible IP settings?.....	92
Q7: How to clear the data logged in a CL-200 module?.....	93
Appendix A: DCON Command Sets.....	94
A-1. CL-201-E DCON Command Sets.....	94
A-2. CL-202-E DCON Command Sets.....	99
A-3. CL-203-E DCON Command Sets.....	104
A-4. CL-204-E DCON Command Sets.....	109

A-5. CL-205-E DCON Command Sets	114
A-6. CL-206-E DCON Command Sets	119
A-7. CL-207-E DCON Command Sets	124
A-8. CL-208-E DCON Command Sets	129
A-9. CL-210-E DCON Command Sets	134
A-10. CL-211 / CL-211-E DCON Command Sets	139
A-11. CL-212 / CL-212-E DCON Command Sets	147
A-12. CL-213 / CL-213-E DCON Command Sets	155
A-13. CL-250-E DCON Command Sets	163
Appendix B: ModbusMasterToolPC.....	168
Appendix C: Modbus Address Table	172
C-1. CL-201-E Modbus Address Mappings (Base 1).....	172
C-2. CL-202-E Modbus Address Mappings (Base 1).....	176
C-3. CL-203-E Modbus Address Mappings (Base 1).....	180
C-4. CL-204-E Modbus Address Mappings (Base 1).....	184
C-5. CL-205-E Modbus Address Mappings (Base 1).....	188
C-6. CL-206-E Modbus Address Mappings (Base 1).....	193
C-7. CL-207-E Modbus Address Mappings (Base 1).....	198
C-8. CL-208-E Modbus Address Mappings (Base 1).....	203
C-9. CL-210-E Modbus Address Mappings (Base 1).....	208
C-10. CL-211 / CL-211-E Modbus Address Mappings (Base 1).....	213
C-11. CL-212 / CL-212-E Modbus Address Mappings (Base 1)	219
C-12. CL-213 / CL-213-E Modbus Address Mappings (Base 1)	225
C-13. CL-250-E Modbus Address Mappings (Base 1).....	232
C-13. Wi-Fi Setting Modbus Address Mappings (Base 1)	236
Revision History	237

1. Introduction

The CL-200 series of data logger devices can be used to record PM2.5, O₂, CO, CO₂, H₂S, NH₃, HCHO, TVOC, temperature, humidity and dew point information, including the date and time stamps, and are able to store up to 450,000 downloadable records. Real-time data can be accessed from the CL-200 data logger from anywhere and at any time using the free Windows software, the iOS App, or the Android App, as long as they are connected to the same local network as the data logger.

The CL-200 series module contains RS-485, Ethernet and PoE communication interfaces, the most common communication interfaces in industrial network. With additional Wi-Fi interface, the CL-200-WF series provides a WLAN connection which makes an easy way to incorporate wireless connectivity into monitoring and control systems.



Characteristics

- ▶ PM2.5 measurement range: 0 to 400 ug/m³
- ▶ O₂ measurement range: 0 ~ 25 %
- ▶ CO measurement range: 0 to 1000 ppm
- ▶ CO₂ measurement range: 0 to 9999 ppm
- ▶ NH₃ measurement range: 0 to 100 ppm
- ▶ H₂S measurement range: 0 to 100 ppm
- ▶ HCHO measurement range: 0 to 2000 ppb
- ▶ TVOC measurement range: 0 to 60000 ppb
- ▶ Non-dispersive Infrared (NDIR) sensor with Automatic Baseline Correction algorithm for CO₂ measurement
- ▶ HCHO : Electrochemical Sensor
- ▶ TVCO : Metal-Oxide Sensor
- ▶ Able to store up to 450,000 records
- ▶ Remote control with a standard web-browser
- ▶ iAir App for iOS or Android mobile devices to monitor on-line data
- ▶ Supports the DCON, Modbus RTU, Modbus TCP protocols
- ▶ Supports the MQTT Protocol for Ethernet Interface
- ▶ One relay output for turning on/off alarm light/buzzer or IAQ control devices
- ▶ Includes RS-485/Ethernet communication interfaces
- ▶ Includes Wi-Fi Interfaces (CL-200-WF Series)
- ▶ Compatible with IEEE802.11b/g/n standards (CL-200-WF Series)
- ▶ Support infrastructure and limit-AP modes for wireless networks(CL-200-WF Series)
- ▶ Wide operating temperature range of 0 to 50°C
- ▶ Indoor use only, Max. altitude 2000 m, Pollution Degree 2.
- ▶ RoHS compliant with no Halogen

Features

▶ NDIR Sensor

NDIR (Non-Dispersion Infrared) is based on one of the natural properties of CO₂ molecules: CO₂ molecules absorb light at a specific wavelength of 4.26 μm. This wavelength is in the infrared (IR) range. High concentrations of CO₂ molecules absorb more light than low concentrations. NDIR sensor can detect fast and accurately in a wide range of CO₂ concentration.

▶ Built-in Web Server

With the built-in Web server, users can easily log in to the CL-200 module via a standard web browser to monitor the data and configure the settings without install any software in the terminal. Please note that the web server is only available to the Ethernet interface.

▶ Get Real-time Data Anywhere and Anytime

iAir App for iOS or Android Phones or Tablets is free and easy to install, it can obtain the real-time data from CL-200 modules over a Wi-Fi network anytime and anywhere. The iAir App can link to the CL-200 modules by specifying IP addresses or by searching all the modules connected to the same Ethernet segment.

▶ Data Logging Software

The DL-300 Utility can be used to configure the modules, monitor real-time data and show the run chart, log alarm events, group CL-200 modules so that the status of distribution groups can be viewed and managed. The utility also allows the log data to be downloaded and exported to a .CSV file that can then be imported into any industry-standard software or spread sheet for analysis.

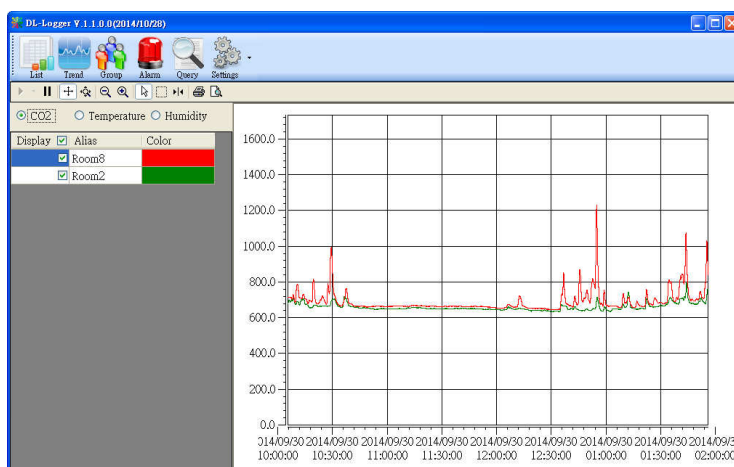

▶ **Easy integration with SCADA software**

Modbus is one of the most popular protocols used in the industrial world. Supporting traditional serial protocols of RS-485 and Ethernet protocols allow the CL-200 series well-integrated into the HMI/SCADA systems.

▶ **Alarm**

CL-200 series allows users to set high alarm level for PM2.5/CO/CO₂/H₂S/NH₃/HCHO/TVOC/Temperature/Humidity/Dew Point and low alarm level for O₂/Temperature /Humidity /Dew Point, and to enable/disable the alarm functions. An Alarm LED indicator on the front of the CL-200 module will flash when an alarm event is activated, and a relay output related to all alarm events can be use to tap an alarm light/sound or control the IAQ devices such as ventilators, air cleaners, and filters. Beep alarm is available when the CO/CO₂/H₂S/NH₃/ HCHO/TVOC high level alarm occurs.

▶ **Automatic Baseline Correction**

The built-in ABC algorithm makes the CO₂ sensor on the CL-202, CL-212, CL-203, CL-213, maintenance-free. In most indoor applications, the carbon dioxide level drops to nearly outside air - 400 ppm, and then the ABC algorithm constantly keeps track of the lowest reading and slowly corrects it as the expected fresh air value of 400 ppm. The ABC algorithm can not apply for the places where are no periods that the CO₂ concentration drops to background level such as greenhouses, hospitals, 24-hour operation factories or stories. The ABC function needs be disabled where the spaces the CO₂ concentration may be elevated at all times.

▶ **Easy Wiring**

Support for RS-485, Ethernet and Power over Ethernet (PoE) interfaces for users to choose the appropriate one to meet the field requirements.

▶ **Power over Ethernet (PoE)**

The CL-200 series features true IEEE802.3af-compliant (classification, Class 1) PoE technology that allows both power and data to be carried over a single Ethernet cable. PoE provides a unified power system, as well as backup provisions for critical building functions, without any additional cables, outlets or connections. It can reduce the power supply wiring and maintenance costs, and improve system scalability.

► Support for MQTT protocol

MQTT is a protocol designed for the efficient exchange of real-time data with sensor and mobile devices. It runs over TCP/IP and is in widest use on the "machine-to-machine" (M2M) and "Internet of Things" applications today

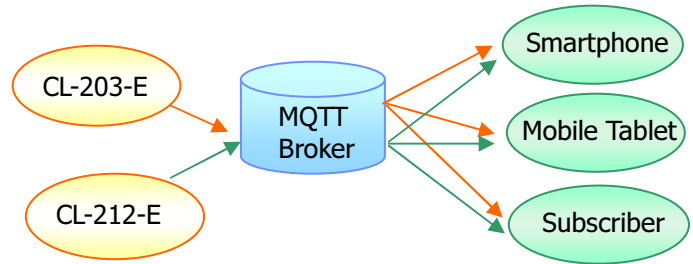

► Compatible with IEEE 802.11b/g/n standards

The CL-200-WF modules are complied with IEEE 802.11b/g/n standard from 2.4~2.5 GHz. It can be used to provide up to 11 Mbps for IEEE 802.11b and 54 Mbps for IEEE 802.11g to connect to your wireless LAN.

2. Hardware

2.1 Specifications

Model	CL-201-E	CL-201-BLE	CL-201-WF
CO Measurement			
Range	0 to 1000 ppm (Electrochemical)		
Resolution	1 ppm		
Accuracy	±5% of measured value		
Response Time	30 seconds		
Warm-up Time	60 seconds		
Life time	5 years		
Re-calibratable	No		
Offset programmable	Yes		
Replaceable (RMA)	Yes		
Temperature Measurement			
Range	-10 to +50°C		
Resolution	0.1°C		
Accuracy	±0.6°C		
Life time	10 years		
Re-calibratable	No		
Offset programmable	Yes		
Replaceable (RMA)	Yes		
Relative Humidity Measurement			
Range	0 to 100% RH, Non-condensing		
Resolution	0.1% RH, Non-condensing		
Accuracy	±5% RH, Non-condensing		
Life time	10 years		
Re-calibratable	No		
Offset programmable	Yes		
Replaceable (RMA)	Yes		
Dew Point			
Range	Calculated using temperature and relative humidity		
Resolution	0.1°C		
System			
CO Alarm	Yes		

Real Time Clock	Yes		
Data Logger	Yes, 450,000 Records		
Alarm Relay Output	Form A x1, SPST. 30 VDC @ 16 A or 150 VAC @ 10 A		
Communication			
Protocol	DCON, Modbus RTU, Modbus TCP, MQTT		
Wire Interface	Yes, RS-485 X 1 and Ethernet/PoE X1		
Wireless Interface	-	Bluetooth	Wi-Fi
Standard Supported	-	BT 4.0	IEEE 802.11 b/g/n
Wireless Mode	-	Slave	Infrastructure/ Limited AP
Wireless Security	-	AES 128	WEP, WPA, WPA2
Transmission Range	-	20 m (LOS)	50 m (LOS)
Electrical			
Powered via Terminal	+10 to +30 VDC		
Powered via PoE	IEEE 802.3af, Class 1 (require a PoE switch or injector)		
Power Consumption	1.7 W	1.8 W	1.9 W
Mechanical			
Dimensions (D x H)	Ø 150 mm x 53 mm		
Installation	Ceiling Mounting or Wall Mounting		
Environment			
Operating	0 to +50°C		
Storage Temperature	-30 to +75°C		
Humidity	10 to 90% RH, Non-condensing		

Model	CL-202-E	CL-202-BLE	CL-202-WF
CO₂ Measurement			
Range	0 ~ 9999 ppm		
Resolution	1 ppm		
Accuracy	±40 ppm ±3%		
Response Time	120 seconds		
Warm-up Time	5 minutes		
Life time	15 years		
Re-calibratable	Yes. (Note2)		

Offset programmable	Yes		
Replaceable (RMA)	Yes		
Temperature Measurement			
Range	-10 to +50°C		
Resolution	0.1°C		
Accuracy	±0.6°C		
Life time	10 years		
Re-calibratable	No		
Offset programmable	Yes		
Replaceable (RMA)	Yes		
Relative Humidity Measurement			
Range	0 to 100% RH, Non-condensing		
Resolution	0.1% RH, Non-condensing		
Accuracy	±5% RH, Non-condensing		
Life time	10 years		
Re-calibratable	No		
Offset programmable	Yes		
Replaceable (RMA)	Yes		
Dew Point			
Range	Calculated using temperature and relative humidity		
Resolution	0.1°C		
System			
CO ₂ Alarm	Yes		
Real Time Clock	Yes		
Data Logger	Yes, 450,000 Records		
Alarm Relay Output	Form A×1, SPST. 30 VDC @ 16 A or 150 VAC @ 10 A		
Communication			
Protocol	DCON, Modbus RTU, Modbus TCP, MQTT		
Wire Interface	Yes, RS-485 X 1 and Ethernet/PoE X1		
Wireless Interface	-	Bluetooth	Wi-Fi
Standard Supported	-	BT 4.0	IEEE 802.11 b/g/n
Wireless Mode	-	Slave	Infrastructure/ Limited AP
Wireless Security	-	AES 128	WEP, WPA ,WPA2
Transmission Range	-	20 m (LOS)	50 m (LOS)

Electrical			
Powered via Terminal	+10 to +30 VDC		
Powered via PoE	IEEE 802.3af, Class 1 (require a PoE switch or injector)		
Power Consumption	1.8 W	1.9 W	2.0 W
Mechanical			
Dimensions (D x H)	Ø 150 mm x 53 mm		
Installation	Ceiling Mounting or Wall Mounting		
Environment			
Operating	0 to +50°C		
Storage Temperature	-30 to +75°C		
Humidity	10 to 90% RH, Non-condensing		

Note2: Customers can perform ABC (Automatic Baseline Calibration) by themselves.

Model	CL-203-E	CL-203-BLE	CL-203-WF
CO Measurement			
Range	0 to 1000 ppm (Electrochemical)		
Resolution	1 ppm		
Accuracy	±5% of measured value		
Response Time	30 seconds		
Warm-up Time	60 seconds		
Life time	5 years		
Re-calibratable	No		
Offset programmable	Yes		
Replaceable (RMA)	Yes		
CO₂ Measurement			
Range	0 ~ 9999 ppm		
Resolution	1 ppm		
Accuracy	±40 ppm ±3%		
Response Time	120 seconds		
Warm-up Time	5 minutes		
Life time	15 years		
Re-calibratable	Yes. (Note2)		
Offset programmable	Yes		

Replaceable (RMA)	Yes		
Temperature Measurement			
Range	-10 to +50°C		
Resolution	0.1°C		
Accuracy	±0.6°C		
Life time	10 years		
Re-calibratable	No		
Offset programmable	Yes		
Replaceable (RMA)	Yes		
Relative Humidity Measurement			
Range	0 to 100% RH, Non-condensing		
Resolution	0.1% RH, Non-condensing		
Accuracy	±5% RH, Non-condensing		
Life time	10 years		
Re-calibratable	No		
Offset programmable	Yes		
Replaceable (RMA)	Yes		
Dew Point			
Range	Calculated using temperature and relative humidity		
Resolution	0.1°C		
System			
CO Alarm	Yes		
CO ₂ Alarm	Yes		
Real Time Clock	Yes		
Data Logger	Yes, 450,000 Records		
Alarm Relay Output	Form A x1, SPST. 30 VDC @ 16 A or 150 VAC @ 10 A		
Communication			
Protocol	DCON, Modbus RTU, Modbus TCP, MQTT		
Wire Interface	Yes, RS-485 X 1 and Ethernet/PoE X1		
Wireless Interface	-	Bluetooth	Wi-Fi
Standard Supported	-	BT 4.0	IEEE 802.11 b/g/n
Wireless Mode	-	Slave	Infrastructure/ Limited AP
Wireless Security	-	AES 128	WEP, WPA, WPA2
Transmission Range	-	20 m (LOS)	50 m (LOS)
Electrical			

Powered via Terminal	+10 to +30 VDC		
Powered via PoE	IEEE 802.3af, Class 1 (require a PoE switch or injector)		
Power Consumption	1.8 W	1.9 W	2.0 W
Mechanical			
Dimensions (D x H)	Ø 150 mm x 53 mm		
Installation	Ceiling Mounting or Wall Mounting		
Environment			
Operating	0 to +50°C		
Storage Temperature	-30 to +75°C		
Humidity	10 to 90% RH, Non-condensing		

Note2: Customers can perform ABC (Automatic Baseline Calibration) by themselves.

Model	CL-204-E	CL-204-BLE	CL-204-WF
HCHO Measurement			
Range	0 to 2000 ppm (Electrochemical)		
Resolution	1 ppm		
Accuracy	-		
Response Time	≤60 seconds		
Warm-up Time	180 seconds		
Life time	3 years		
Re-calibratable	No		
Offset programmable	Yes		
Replaceable (RMA)	Yes		
TVOC Measurement			
Range	0 to 60000 ppb (MEMS Metal Oxide)		
Resolution	1 ppb		
Accuracy	±15%		
Response Time	60 seconds		
Warm-up Time	180 seconds		
Life time	5 years		
Re-calibratable	No		
Offset programmable	Yes		
Replaceable (RMA)	Yes		

Temperature Measurement			
Range	-10 to +50°C		
Resolution	0.1°C		
Accuracy	±0.6°C		
Life time	10 years		
Re-calibratable	No		
Offset programmable	Yes		
Replaceable (RMA)	Yes		
Relative Humidity Measurement			
Range	0 to 100% RH, Non-condensing		
Resolution	0.1% RH, Non-condensing		
Accuracy	±5% RH, Non-condensing		
Life time	10 years		
Re-calibratable	No		
Offset programmable	Yes		
Replaceable (RMA)	Yes		
Dew Point			
Range	Calculated using temperature and relative humidity		
Resolution	0.1°C		
System			
HCHO Alarm	Yes		
TVOC Alarm	Yes		
Real Time Clock	Yes		
Data Logger	Yes, 450,000 Records		
Alarm Relay Output	Form A x1, SPST. 30 VDC @ 16 A or 150 VAC @ 10 A		
Communication			
Protocol	DCON, Modbus RTU, Modbus TCP, MQTT		
Wire Interface	Yes, RS-485 X 1 and Ethernet/PoE X1		
Wireless Interface	-	Bluetooth	Wi-Fi
Standard Supported	-	BT 4.0	IEEE 802.11 b/g/n
Wireless Mode	-	Slave	Infrastructure/ Limited AP
Wireless Security	-	AES 128	WEP, WPA, WPA2
Transmission Range	-	20 m (LOS)	50 m (LOS)
Electrical			
Powered via Terminal	+10 to +30 VDC		

Powered via PoE	IEEE 802.3af, Class 1 (require a PoE switch or injector)		
Power Consumption	2.0 W	2.1 W	2.2 W
Mechanical			
Dimensions (D x H)	Ø 150 mm x 53 mm		
Installation	Ceiling Mounting or Wall Mounting		
Environment			
Operating	0 to +50°C		
Storage Temperature	-30 to +75°C		
Humidity	10 to 90% RH, Non-condensing		

Model	CL-205-E	CL-205-BLE	CL-205-WF
NH3 Measurement			
Range	0 to 100 ppm (Electrochemical)		
Resolution	1 ppm		
Accuracy	±5% of measured value		
Response Time	< 120 Sec		
Warm-up Time	180 Sec		
Life time	2 years		
Re-calibratable	No		
Offset programmable	Yes		
Replaceable (RMA)	Yes		
Temperature Measurement			
Range	-10 to +50°C		
Resolution	0.1°C		
Accuracy	±0.6°C		
Life time	10 years		
Re-calibratable	No		
Offset programmable	Yes		
Replaceable (RMA)	Yes		
Relative Humidity Measurement			
Range	0 to 100% RH, Non-condensing		
Resolution	0.1% RH, Non-condensing		
Accuracy	±5% RH, Non-condensing		
Life time	10 years		

Re-calibratable	No		
Offset programmable	Yes		
Replaceable (RMA)	Yes		
Dew Point			
Range	Calculated using temperature and relative humidity		
Resolution	0.1°C		
System			
NH3 Alarm	Yes		
Real Time Clock	Yes		
Data Logger	Yes, 450,000 Records		
Alarm Relay Output	Form A x1, SPST. 30 VDC @ 16 A or 150 VAC @ 10 A		
Communication			
Protocol	DCON, Modbus RTU, Modbus TCP, MQTT		
Wire Interface	Yes, RS-485 X 1 and Ethernet/PoE X1		
Wireless Interface	-	Bluetooth	Wi-Fi
Standard Supported	-	BT 4.0	IEEE 802.11 b/g/n
Wireless Mode	-	Slave	Infrastructure/ Limited AP
Wireless Security	-	AES 128	WEP, WPA ,WPA2
Transmission Range	-	20 m (LOS)	50 m (LOS)
Electrical			
Powered via Terminal	+10 to +30 VDC		
Powered via PoE	IEEE 802.3af, Class 1 (require a PoE switch or injector)		
Power Consumption	1.9 W	2.2 W	2.2 W
Mechanical			
Dimensions (D x H)	Ø 150 mm x 53 mm		
Installation	Ceiling Mounting or Wall Mounting		
Environment			
Operating	0 to +50°C		
Storage Temperature	-30 to +75°C		
Humidity	10 to 90% RH, Non-condensing		

Model	CL-206-E	CL-206-BLE	CL-206-WF
H2S Measurement			
Range	0 to 100 ppm (Electrochemical)		
Resolution	1 ppm		
Accuracy	±5% of measured value		
Response Time	< 120 Sec		
Warm-up Time	180 Sec		
Life time	2 years		
Re-calibratable	No		
Offset programmable	Yes		
Replaceable (RMA)	Yes		
Temperature Measurement			
Range	-10 to +50°C		
Resolution	0.1°C		
Accuracy	±0.6°C		
Life time	10 years		
Re-calibratable	No		
Offset programmable	Yes		
Replaceable (RMA)	Yes		
Relative Humidity Measurement			
Range	0 to 100% RH, Non-condensing		
Resolution	0.1% RH, Non-condensing		
Accuracy	±5% RH, Non-condensing		
Life time	10 years		
Re-calibratable	No		
Offset programmable	Yes		
Replaceable (RMA)	Yes		
Dew Point			
Range	Calculated using temperature and relative humidity		
Resolution	0.1°C		
System			
H2S Alarm	Yes		
Real Time Clock	Yes		
Data Logger	Yes, 450,000 Records		
Alarm Relay Output	Form Ax1, SPST. 30 VDC @ 16 A or 150 VAC @ 10 A		

Communication			
Protocol	DCON, Modbus RTU, Modbus TCP, MQTT		
Wire Interface	Yes, RS-485 X 1 and Ethernet/PoE X1		
Wireless Interface	-	Bluetooth	Wi-Fi
Standard Supported	-	BT 4.0	IEEE 802.11 b/g/n
Wireless Mode	-	Slave	Infrastructure/ Limited AP
Wireless Security	-	AES 128	WEP, WPA, WPA2
Transmission Range	-	20 m (LOS)	50 m (LOS)
Electrical			
Powered via Terminal	+10 to +30 VDC		
Powered via PoE	IEEE 802.3af, Class 1 (require a PoE switch or injector)		
Power Consumption	1.9 W	2.2 W	2.2 W
Mechanical			
Dimensions (D x H)	Ø 150 mm x 53 mm		
Installation	Ceiling Mounting or Wall Mounting		
Environment			
Operating	0 to +50°C		
Storage Temperature	-30 to +75°C		
Humidity	10 to 90% RH, Non-condensing		

Model	CL-207-E	CL-207-BLE	CL-207-WF
HCHO Measurement			
Range	0 to 2000 ppm (Electrochemical)		
Resolution	1 ppm		
Accuracy	-		
Response Time	≤60 seconds		
Warm-up Time	180 seconds		
Life time	3 years		
Re-calibratable	No		
Offset programmable	Yes		
Replaceable (RMA)	Yes		

Temperature Measurement			
Range	-10 to +50°C		
Resolution	0.1°C		
Accuracy	±0.6°C		
Life time	10 years		
Re-calibratable	No		
Offset programmable	Yes		
Replaceable (RMA)	Yes		
Relative Humidity Measurement			
Range	0 to 100% RH, Non-condensing		
Resolution	0.1% RH, Non-condensing		
Accuracy	±5% RH, Non-condensing		
Life time	10 years		
Re-calibratable	No		
Offset programmable	Yes		
Replaceable (RMA)	Yes		
Dew Point			
Range	Calculated using temperature and relative humidity		
Resolution	0.1°C		
System			
HCHO Alarm	Yes		
Real Time Clock	Yes		
Data Logger	Yes, 450,000 Records		
Alarm Relay Output	Form A x1, SPST. 30 VDC @ 16 A or 150 VAC @ 10 A		
Communication			
Protocol	DCON, Modbus RTU, Modbus TCP, MQTT		
Wire Interface	Yes, RS-485 X 1 and Ethernet/PoE X1		
Wireless Interface	-	Bluetooth	Wi-Fi
Standard Supported	-	BT 4.0	IEEE 802.11 b/g/n
Wireless Mode	-	Slave	Infrastructure/ Limited AP
Wireless Security	-	AES 128	WEP, WPA, WPA2
Transmission Range	-	20 m (LOS)	50 m (LOS)
Electrical			
Powered via Terminal	+10 to +30 VDC		
Powered via PoE	IEEE 802.3af, Class 1 (require a PoE switch or injector)		

Power Consumption	2.0 W	2.1 W	2.1 W
Mechanical			
Dimensions (D x H)	Ø 150 mm x 53 mm		
Installation	Ceiling Mounting or Wall Mounting		
Environment			
Operating	0 to +50°C		
Storage Temperature	-30 to +75°C		
Humidity	10 to 90% RH, Non-condensing		

Model	CL-208-E	CL-208-BLE	CL-208-WF
TVOC Measurement			
Range	0 to 60000 ppb (MEMS Metal Oxide)		
Resolution	1 ppb		
Accuracy	±15%		
Response Time	60 seconds		
Warm-up Time	180 seconds		
Life time	5 years		
Re-calibratable	No		
Offset programmable	Yes		
Replaceable (RMA)	Yes		
Temperature Measurement			
Range	-10 to +50°C		
Resolution	0.1°C		
Accuracy	±0.6°C		
Life time	10 years		
Re-calibratable	No		
Offset programmable	Yes		
Replaceable (RMA)	Yes		
Relative Humidity Measurement			
Range	0 to 100% RH, Non-condensing		
Resolution	0.1% RH, Non-condensing		
Accuracy	±5% RH, Non-condensing		
Life time	10 years		
Re-calibratable	No		

Offset programmable	Yes		
Replaceable (RMA)	Yes		
Dew Point			
Range	Calculated using temperature and relative humidity		
Resolution	0.1°C		
System			
TVOC Alarm	Yes		
Real Time Clock	Yes		
Data Logger	Yes, 450,000 Records		
Alarm Relay Output	Form Ax1, SPST. 30 VDC @ 16 A or 150 VAC @ 10 A		
Communication			
Protocol	DCON, Modbus RTU, Modbus TCP, MQTT		
Wire Interface	Yes, RS-485 X 1 and Ethernet/PoE X1		
Wireless Interface	-	Bluetooth	Wi-Fi
Standard Supported	-	BT 4.0	IEEE 802.11 b/g/n
Wireless Mode	-	Slave	Infrastructure/ Limited AP
Wireless Security	-	AES 128	WEP, WPA ,WPA2
Transmission Range	-	20 m (LOS)	50 m (LOS)
Electrical			
Powered via Terminal	+10 to +30 VDC		
Powered via PoE	IEEE 802.3af, Class 1 (require a PoE switch or injector)		
Power Consumption	1.9 W	2.0 W	2.0 W
Mechanical			
Dimensions (D x H)	Ø 150 mm x 53 mm		
Installation	Ceiling Mounting or Wall Mounting		
Environment			
Operating	0 to +50°C		
Storage Temperature	-30 to +75°C		
Humidity	10 to 90% RH, Non-condensing		

Model	CL-210-E	CL-210-BLE	CL-210-WF
PM2.5 Measurement			
Range	0 to 400 ug/m ³		
Resolution	1ug/m ³		
Response Time	<=1 min.		
Life time	5 years (Note1)		
Re-calibratable	No		
Offset programmable	Yes		
Replaceable (RMA)	Yes		
Temperature Measurement			
Range	-10 to +50°C		
Resolution	0.1°C		
Accuracy	±0.6°C		
Life time	10 years		
Re-calibratable	No		
Offset programmable	Yes		
Replaceable (RMA)	Yes		
Relative Humidity Measurement			
Range	0 to 100% RH, Non-condensing		
Resolution	0.1% RH, Non-condensing		
Accuracy	±5% RH, Non-condensing		
Life time	10 years		
Re-calibratable	No		
Offset programmable	Yes		
Replaceable (RMA)	Yes		
Dew Point			
Range	Calculated using temperature and relative humidity		
Resolution	0.1°C		
System			
CO Alarm	-		
CO ₂ Alarm	-		
PM2.5 Alarm	Yes		
Real Time Clock	Yes		
Data Logger	Yes, 450,000 Records		
Alarm Relay Output	Form A×1, SPST. 30 VDC @ 16 A or 150 VAC @ 10 A		

Communication			
Protocol	DCON, Modbus RTU, Modbus TCP, MQTT		
Wire Interface	Yes, RS-485 X 1 and Ethernet/PoE X1		
Wireless Interface	-	Bluetooth	Wi-Fi
Standard Supported	-	BT 4.0	IEEE 802.11 b/g/n
Wireless Mode	-	Slave	Infrastructure/ Limited AP
Wireless Security	-	AES 128	WEP, WPA ,WPA2
Transmission Range	-	20 m (LOS)	50 m (LOS)
Electrical			
Powered via Terminal	+10 to +30 VDC		
Powered via PoE	IEEE 802.3af, Class 1 (require a PoE switch or injector)		
Power Consumption	1.7 W	1.8 W	1.8 W
Mechanical			
Dimensions (D x H)	Ø 150 mm x 53 mm		
Installation	Ceiling Mounting or Wall Mounting		
Environment			
Operating	0 to +50°C		
Storage Temperature	-30 to +75°C		
Humidity	10 to 90% RH, Non-condensing		

Note1: Customers have to periodically replace the filter patch in 3~6 months.

Model	CL-211	CL-211-E	CL-211-BLE	CL-211-WF
PM2.5 Measurement				
Range	0 to 400 ug/m ³			
Resolution	1ug/m ³			
Response Time	<=1 min.			
Life time	5 years (Note1)			
Re-calibratable	No			
Offset programmable	Yes			
Replaceable (RMA)	Yes			

CO Measurement			
Range	0 to 1000 ppm (Electrochemical)		
Resolution	1 ppm		
Accuracy	±5% of measured value		
Response Time	30 seconds		
Warm-up Time	60 seconds		
Life time	5 years		
Temperature Measurement			
Range	-10 to +50°C		
Resolution	0.1°C		
Accuracy	±0.6°C		
Relative Humidity Measurement			
Range	0 to 100% RH, Non-condensing		
Resolution	0.1% RH, Non-condensing		
Accuracy	±5% RH, Non-condensing		
Life time	10 years		
Dew Point			
Range	Calculated using temperature and relative humidity		
Resolution	0.1°C		
System			
CO Alarm	Yes		
CO ₂ Alarm	-		
PM2.5 Alarm	Yes		
Real Time Clock	Yes		
Data Logger	Yes, 450,000 Records		
Alarm Relay Output	Form A x1, SPST. 30 VDC @ 16 A or 150 VAC @ 10 A		
Communication			
Protocol	DCON, Modbus RTU	DCON, Modbus RTU, Modbus TCP, MQTT	
Wire Interface	Yes, RS-485	Yes, RS-485 X 1 and Ethernet/PoE X1	
Wireless Interface	-	Bluetooth	Wi-Fi
Standard Supported	-	BT 4.0	IEEE 802.11 b/g/n
Wireless Mode	-	Slave	Infrastructure/ Limited AP
Wireless Security	-	AES 128	WEP, WPA, WPA2
Transmission Range	-	20 m (LOS)	50 m (LOS)

Electrical				
Powered via Terminal Block	+10 to +30 VDC			
Powered via PoE	-	IEEE 802.3af, Class 1 (require a PoE switch or injector)		
Power Consumption	1.2 W	2.0 W	2.0 W	2.1 W
Mechanical				
Dimensions (D x H)	Ø 150 mm x 53 mm			
Installation	Ceiling Mounting or Wall Mounting			
Environment				
Operating	0 to +50°C			
Storage Temperature	-30 to +75°C			
Humidity	10 to 90% RH, Non-condensing			

Note1: Customers have to periodically replace the filter patch in 3~6 months.

Model	CL-212	CL-212-E	CL-212-BLE	CL-212-WF
PM2.5 Measurement				
Range	0 to 400 ug/m ³			
Resolution	1ug/m ³			
Response Time	<=1 min.			
Life time	5 years (Note1)			
Re-calibratable	No			
Offset programmable	Yes			
Replaceable (RMA)	Yes			
CO₂ Measurement				
Range	0 ~ 9999 ppm			
Resolution	1 ppm			
Accuracy	±40 ppm ±3%			
Response Time	120 seconds			
Warm-up Time	5 minutes			
Life time	15 years			
Re-calibratable	Yes. (Note2)			

Offset programmable	Yes		
Replaceable (RMA)	Yes		
Temperature Measurement			
Range	-10 to +50°C		
Resolution	0.1°C		
Accuracy	±0.6°C		
Life time	10 years		
Re-calibratable	No		
Offset programmable	Yes		
Replaceable (RMA)	Yes		
Relative Humidity Measurement			
Range	0 to 100% RH, Non-condensing		
Resolution	0.1% RH, Non-condensing		
Accuracy	±5% RH, Non-condensing		
Life time	10 years		
Re-calibratable	No		
Offset programmable	Yes		
Replaceable (RMA)	Yes		
Dew Point			
Range	Calculated using temperature and relative humidity		
Resolution	0.1°C		
System			
CO Alarm	-		
CO ₂ Alarm	Yes		
PM2.5 Alarm	Yes		
Real Time Clock	Yes		
Data Logger	Yes, 450,000 Records		
Alarm Relay Output	Form A x1, SPST. 30 VDC @ 16 A or 150 VAC @ 10 A		
Communication			
Protocol	DCON, Modbus RTU	DCON, Modbus RTU, Modbus TCP, MQTT	
Wire Interface	Yes, RS-485 X 1	Yes, RS-485 X 1 and Ethernet/PoE X1	
Wireless Interface	-	Bluetooth	Wi-Fi
Standard Supported	-	BT 4.0	IEEE 802.11 b/g/n
Wireless Mode	-	Slave	Infrastructure/ Limited AP

Wireless Security	-	AES 128	WEP, WPA ,WPA2	
Transmission Range	-	20 m (LOS)	50 m (LOS)	
Electrical				
Powered via Terminal Block	+10 to +30 VDC			
Powered via PoE	-	IEEE 802.3af, Class 1 (require a PoE switch or injector)		
Power Consumption	1.2 W	2.1 W	2.2 W	2.2 W
Mechanical				
Dimensions (D x H)	Ø 150 mm x 53 mm			
Installation	Ceiling Mounting or Wall Mounting			
Environment				
Operating	0 to +50°C			
Storage Temperature	-30 to +75°C			
Humidity	10 to 90% RH, Non-condensing			

Note1: Customers have to periodically replace the filter patch in 3~6 months.

Note2: Customers can perform ABC (Automatic Baseline Calibration) by themselves.

Model	CL-213	CL-213-E	CL-213-BLE	CL-213-WF
PM2.5 Measurement				
Range	0 to 400 ug/m ³			
Resolution	1ug/m ³			
Response Time	<=1 min.			
Life time	5 years (Note1)			
Re-calibratable	No			
Offset programmable	Yes			
Replaceable (RMA)	Yes			
CO Measurement				
Range	0 to 1000 ppm (Electrochemical)			
Resolution	1 ppm			
Accuracy	±5% of measured value			
Response Time	30 seconds			

Warm-up Time	60 seconds
Life time	5 years
Re-calibratable	No
Offset programmable	Yes
Replaceable (RMA)	Yes
CO₂ Measurement	
Range	0 ~ 9999 ppm
Resolution	1 ppm
Accuracy	±40 ppm ±3%
Response Time	120 seconds
Warm-up Time	5 minutes
Life time	15 years
Re-calibratable	Yes. (Note2)
Offset programmable	Yes
Replaceable (RMA)	Yes
Temperature Measurement	
Range	-10 to +50°C
Resolution	0.1°C
Accuracy	±0.6°C
Life time	10 years
Re-calibratable	No
Offset programmable	Yes
Replaceable (RMA)	Yes
Relative Humidity Measurement	
Range	0 to 100% RH, Non-condensing
Resolution	0.1% RH, Non-condensing
Accuracy	±5% RH, Non-condensing
Life time	10 years
Re-calibratable	No
Offset programmable	Yes
Replaceable (RMA)	Yes
Dew Point	
Range	Calculated using temperature and relative humidity
Resolution	0.1°C
System	
CO Alarm	Yes

CO ₂ Alarm	Yes			
PM2.5 Alarm	Yes			
Real Time Clock	Yes			
Data Logger	Yes, 450,000 Records			
Alarm Relay Output	Form A x1, SPST. 30 VDC @ 16 A or 150 VAC @ 10 A			
Communication				
Protocol	DCON, Modbus RTU	DCON, Modbus RTU, Modbus TCP, MQTT		
Wire Interface	Yes, RS-485 X 1	Yes, RS-485 X 1 and Ethernet/PoE X1		
Wireless Interface	-	Bluetooth	Wi-Fi	
Standard Supported	-	BT 4.0	IEEE 802.11 b/g/n	
Wireless Mode	-	Slave	Infrastructure/ Limited AP	
Wireless Security	-	AES 128	WEP, WPA, WPA2	
Transmission Range	-	20 m (LOS)	50 m (LOS)	
Electrical				
Powered via Terminal Block	+10 to +30 VDC			
Powered via PoE	-	IEEE 802.3af, Class 1 (require a PoE switch or injector)		
Power Consumption	1.2 W	2.1 W	2.2 W	2.2 W
Mechanical				
Dimensions (D x H)	Ø 150 mm x 53 mm			
Installation	Ceiling Mounting or Wall Mounting			
Environment				
Operating	0 to +50°C			
Storage Temperature	-30 to +75°C			
Humidity	10 to 90% RH, Non-condensing			

Note1: Customers have to periodically replace the filter patch in 3~6 months.

Note2: Customers can perform ABC (Automatic Baseline Calibration) by themselves.

Model	CL-250-E	CL-250-WF
O₂ Measurement		
Range	0~25%	
Resolution	0.01%	
Accuracy	2% of FSR	
Response Time	< 30 secs (typical)	
Warm-up Time	120 seconds	
Life time	> 5 years	
Re-calibratable	No	
Offset programmable	Yes	
Replaceable (RMA)	Yes	
Temperature Measurement		
Range	-10 to +50°C	
Resolution	0.1°C	
Accuracy	±0.6°C	
Life time	10 years	
Re-calibratable	No	
Offset programmable	Yes	
Replaceable (RMA)	Yes	
Relative Humidity Measurement		
Range	0 to 100% RH, Non-condensing	
Resolution	0.1% RH, Non-condensing	
Accuracy	±5% RH, Non-condensing	
Life time	10 years	
Re-calibratable	No	
Offset programmable	Yes	
Replaceable (RMA)	Yes	
Dew Point		
Range	Calculated using temperature and relative humidity	
Resolution	0.1°C	
System		
CO Alarm	-	
CO ₂ Alarm	-	
O ₂ Alarm	Yes	
Real Time Clock	Yes	
Data Logger	Yes, 450,000 Records	

Alarm Relay Output	Form A x1, SPST. 30 VDC @ 16 A or 150 VAC @ 10 A	
Communication		
Protocol	DCON, Modbus RTU, Modbus TCP, MQTT	
Wire Interface	Yes, RS-485 X 1 and Ethernet/PoE X1	
Wireless Interface	-	Wi-Fi
Standard Supported	-	IEEE 802.11 b/g/n
Wireless Mode	-	Infrastructure / Limited AP
Wireless Security	-	WEP, WPA ,WPA2
Transmission Range	-	50 m (LOS)
Electrical		
Powered via Terminal	+10 to +30 VDC	
Powered via PoE	IEEE 802.3af, Class 1 (require a PoE switch or injector)	
Power Consumption	1.7 W	1.9 W
Mechanical		
Dimensions (D x H)	Ø 150 mm x 53 mm	
Installation	Ceiling Mounting or Wall Mounting	
Environment		
Operating	0 to +50°C	
Storage Temperature	-30 to +75°C	
Humidity	10 to 90% RH, Non-condensing	

2.2 Appearance

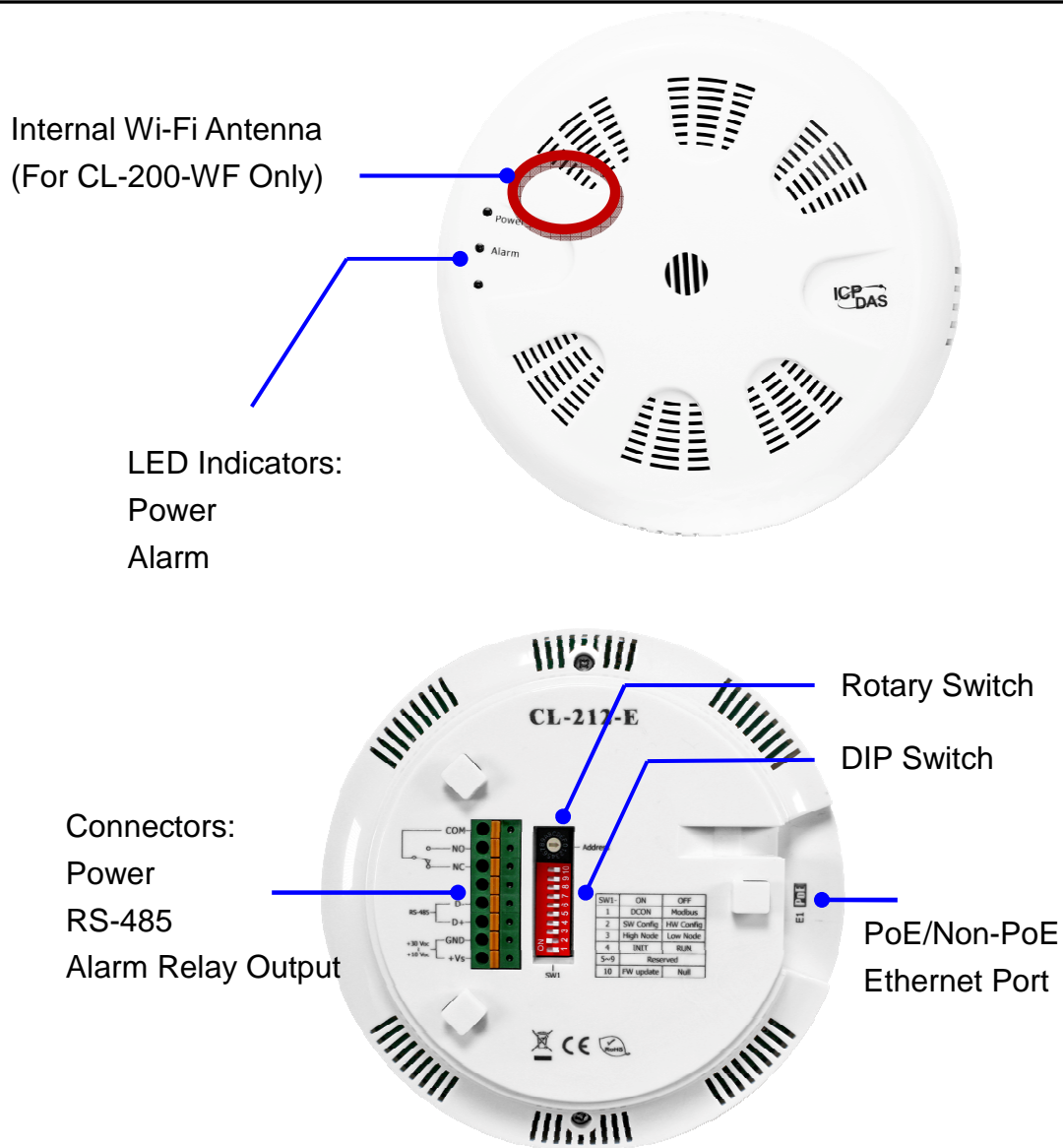

LED Indicators

- ▶ PWR: Red for normal operation.
- ▶ Alarm: Green for alarm condition.

DIP Switch

The functions are printed on the right beside the SW1 DIP switch.

PoE/ non-PoE Ethernet port

The Ethernet port can be used to connect to a PoE switch or a non-PoE switch.

Connector for Power/ Frame Ground / RS-485/ Alarm Relay Output

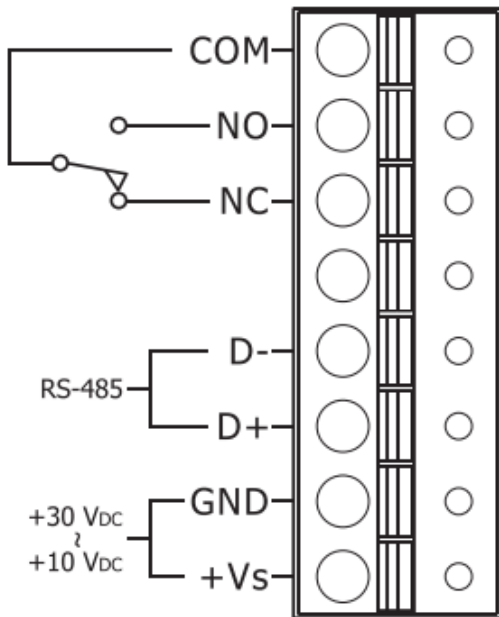

The Push-in connector can easily connect and detach solid wires or wires with wire-end ferrules without using tools. Just push in the solid wire to lock it and press the white button to release the wire.

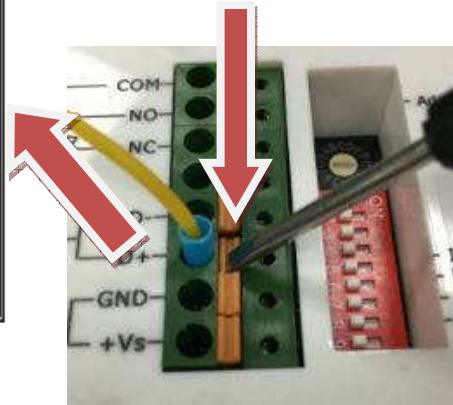

Wire requirement:

- Stripping length: 8 ~ 10 mm
- 0.20 - 1.5 mm² (IEC) / 28 - 16 AWG (UL)

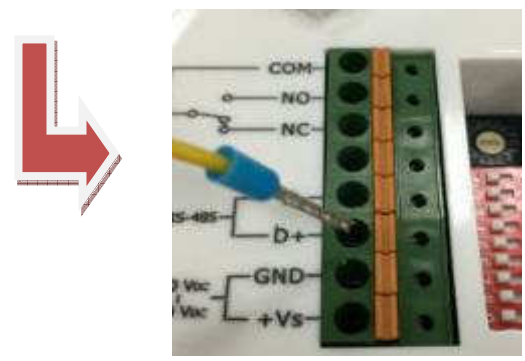

Relay Output Wire Connection

Output Type	ON State Readback as 1	OFF State Readback as 0
Relay Output		

2.3 Dimensions (unit: mm)

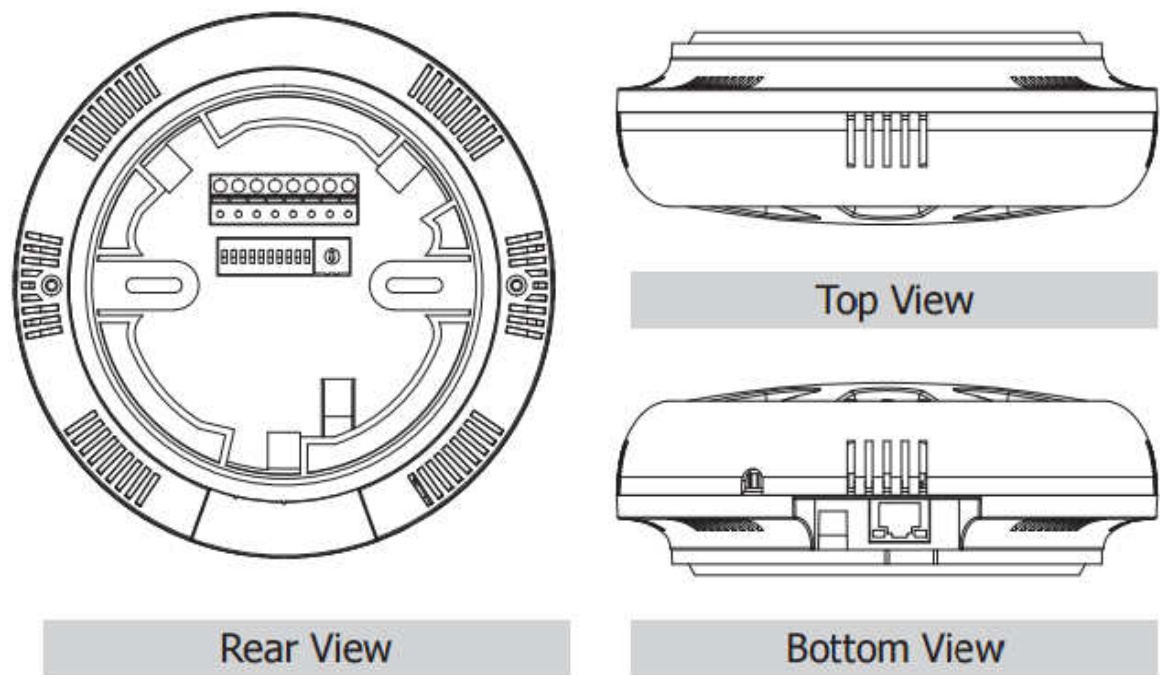
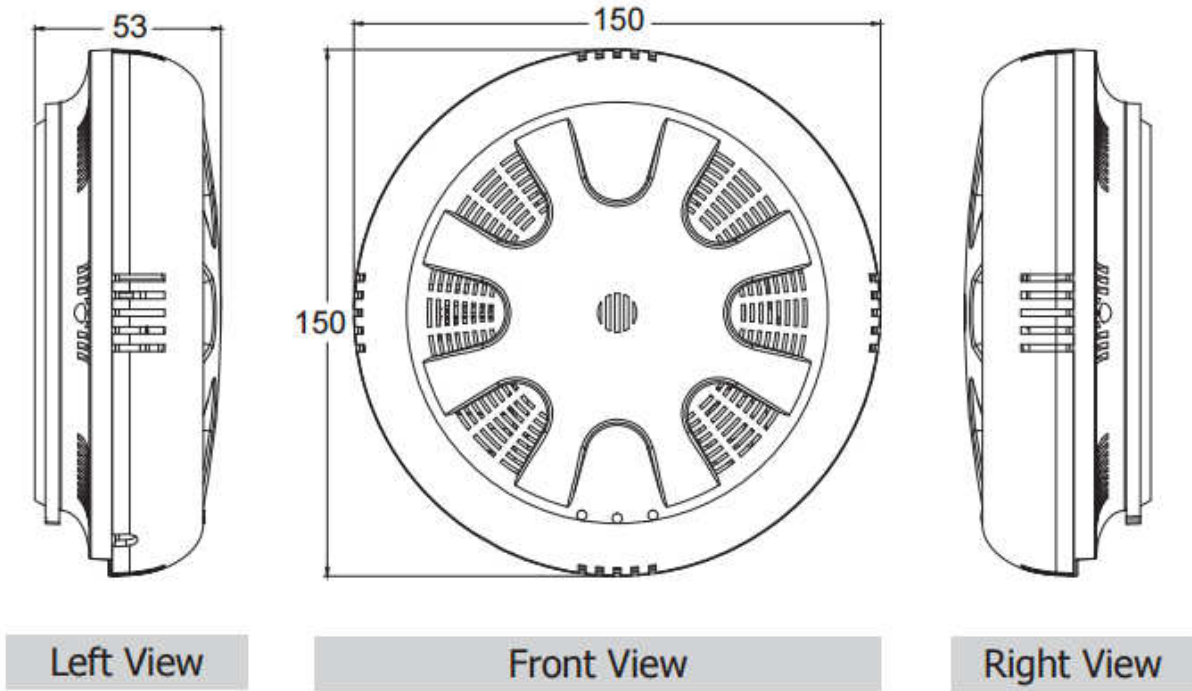

2.4 Cabling for Power and Network

Note

- Do not install the CL-200 module near a vent, a ventilation fan or a door where the air flows faster.
- Avoid installing in locations near a strong electromagnetic field.
- This device is intended to be supplied by an IEC/EN 60950-1 or IEC/EN 62368-1 approved power supply suitable for use at 50 °C minimum, output rated 10-30 Vdc, 0.5 A minimum.

For connecting with a PC or a Android device

The CL-200 logger can connect to a PoE network without a power source or connect to a non-PoE network. When using the Search function in iAir App on Android or iOS mobile devices, mobile devices need to connect to the same subnet that the CL-200 connected to over Wi-Fi. Similarly to using the Search function in DL-300 Utility running on Windows, the module and the host PC need to connect on the same subnet, too.

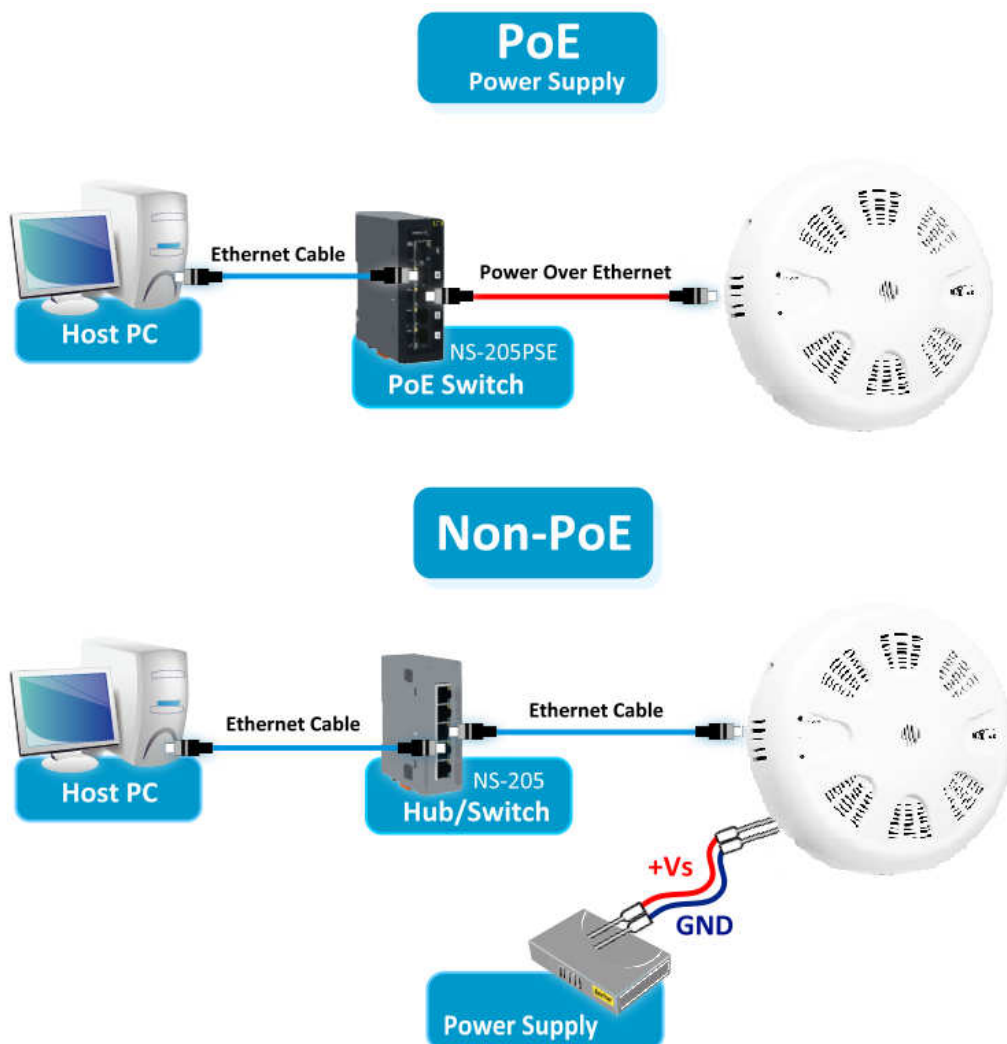

The iAir App and DL-300 Utility search the logger by broadcast, therefore only the devices on the same subnet can be searched out. It means that the host PC, Android devices and the logger must have the same broadcast address. The broadcast address for an IPv4 device can be obtained by performing a bitwise OR operation between the bit complement of the subnet mask and the IP address for a device. In other words, take the device's IP address, and set to '1' any bit positions which hold a '0' in the subnet mask.

For example, in an entire IPv4 subnet, the host PC or the Android device uses the private IP address space 172.16.0.0/12 and subnet mask address 255.240.0.0, the broadcast address is $172.16.0.0 \mid 0.15.255.255 = 172.31.255.255$. Only the loggers which have the same broadcast address could be searched out in the iAir App or DL-200 Utility. Please contact with your network administrator to make sure the CL-200 logger is connected to the same sub-network that your Android devices or PC is connected to.

For connecting with PC via RS-485 network

The CL-200 logger can connect to the PC through a RS-485 network with power input requirement of +10 ~ +30 VDC.

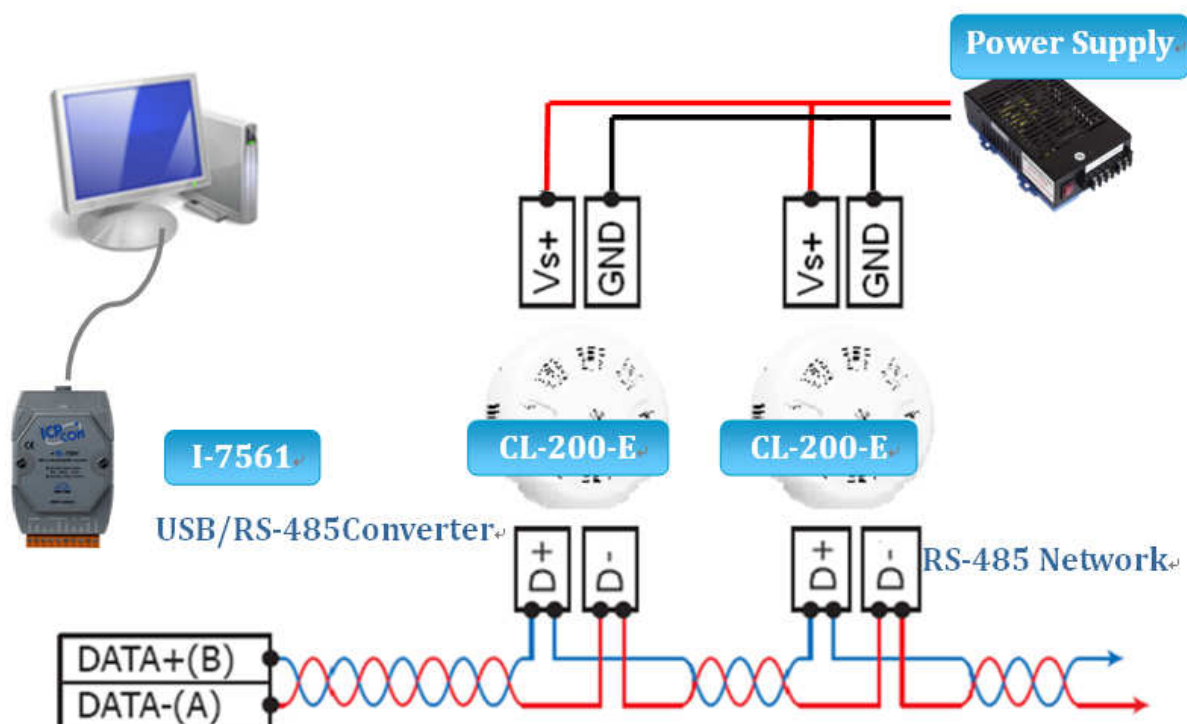

For connecting with PC via Wi-Fi

The CL-200-WF logger can connect to the PC through Wi-Fi with power input requirement of +10 ~ +30 V_{DC}.

The CL-200-WF device can be configured as station mode, such that the PC/Laptop can be connected through Wi-Fi AP.

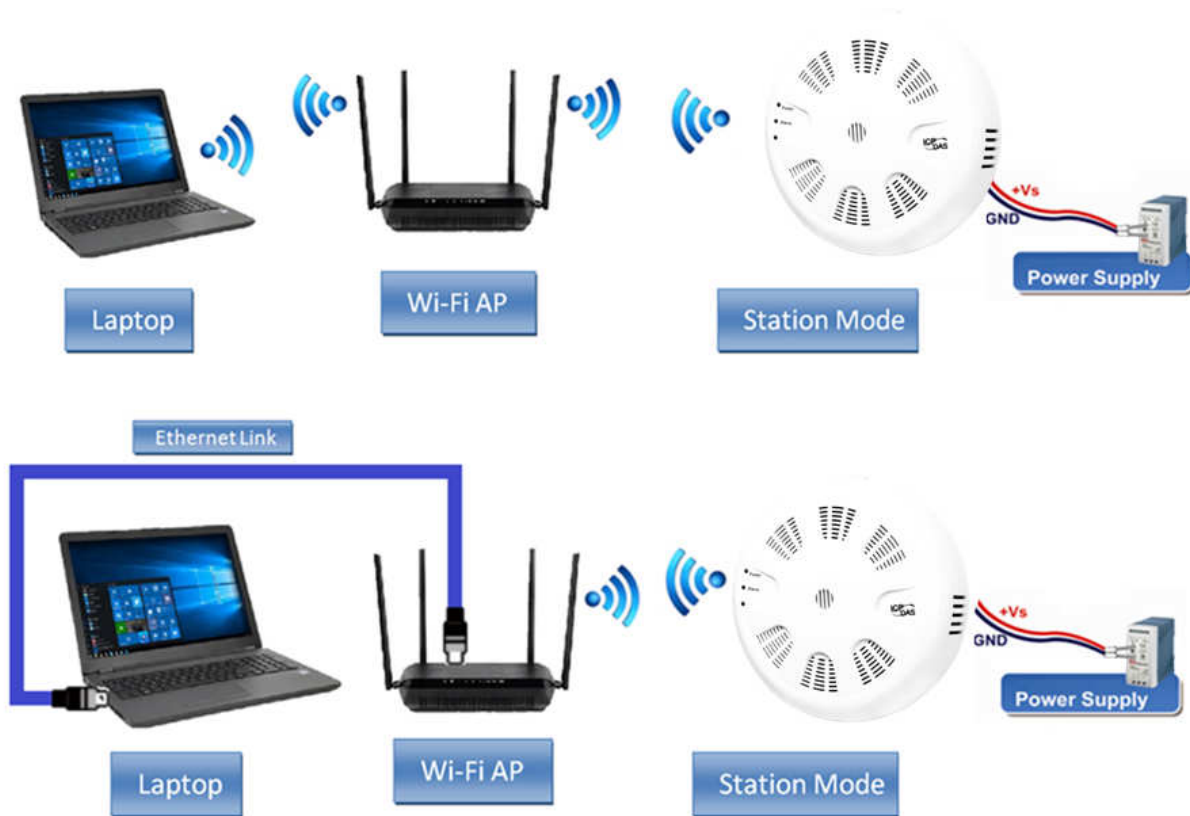

The CL-200-WF device can be configured as AP mode, such that the PC/Laptop can be connected through Wi-Fi directly. Only one device is allowed to be connected to the DL-300-WF module in AP mode.

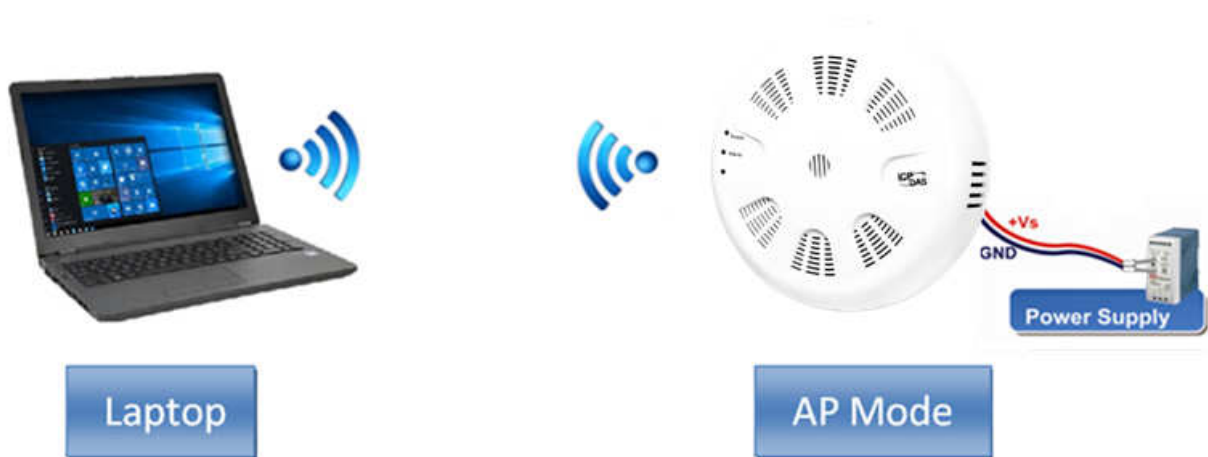

2.5 Hardware Mounting

■ Ceiling Mounting

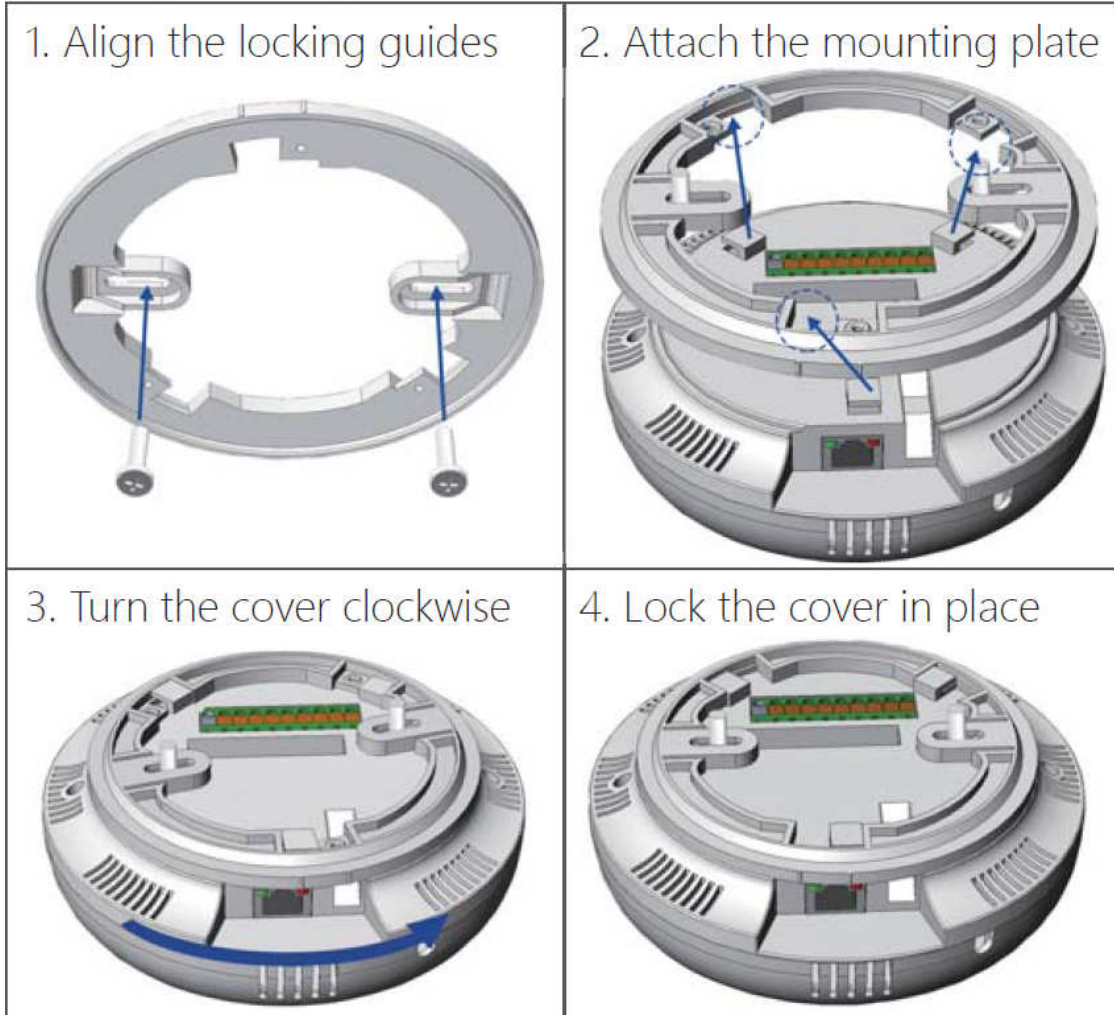

■ Wall Mounting

(Requires External Wall Box EWB-C150)

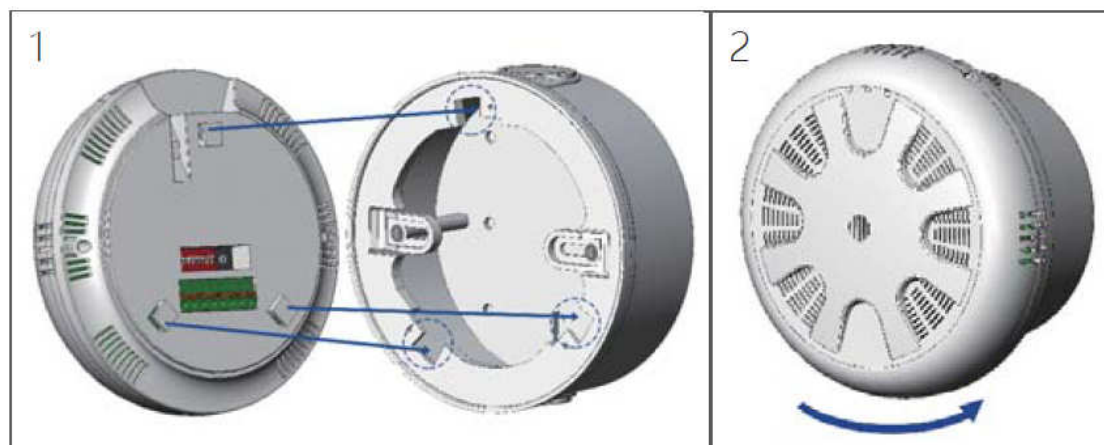

RJ45 Cable Mounting

CL-2xx-E (Ethernet Type) are with optional angle-bent RJ45 cable to smoothly install the Ethernet plug in the hole of the ceiling-mounted.

(Requires RJ45 Cable, Male-Female, 30cm (90°))

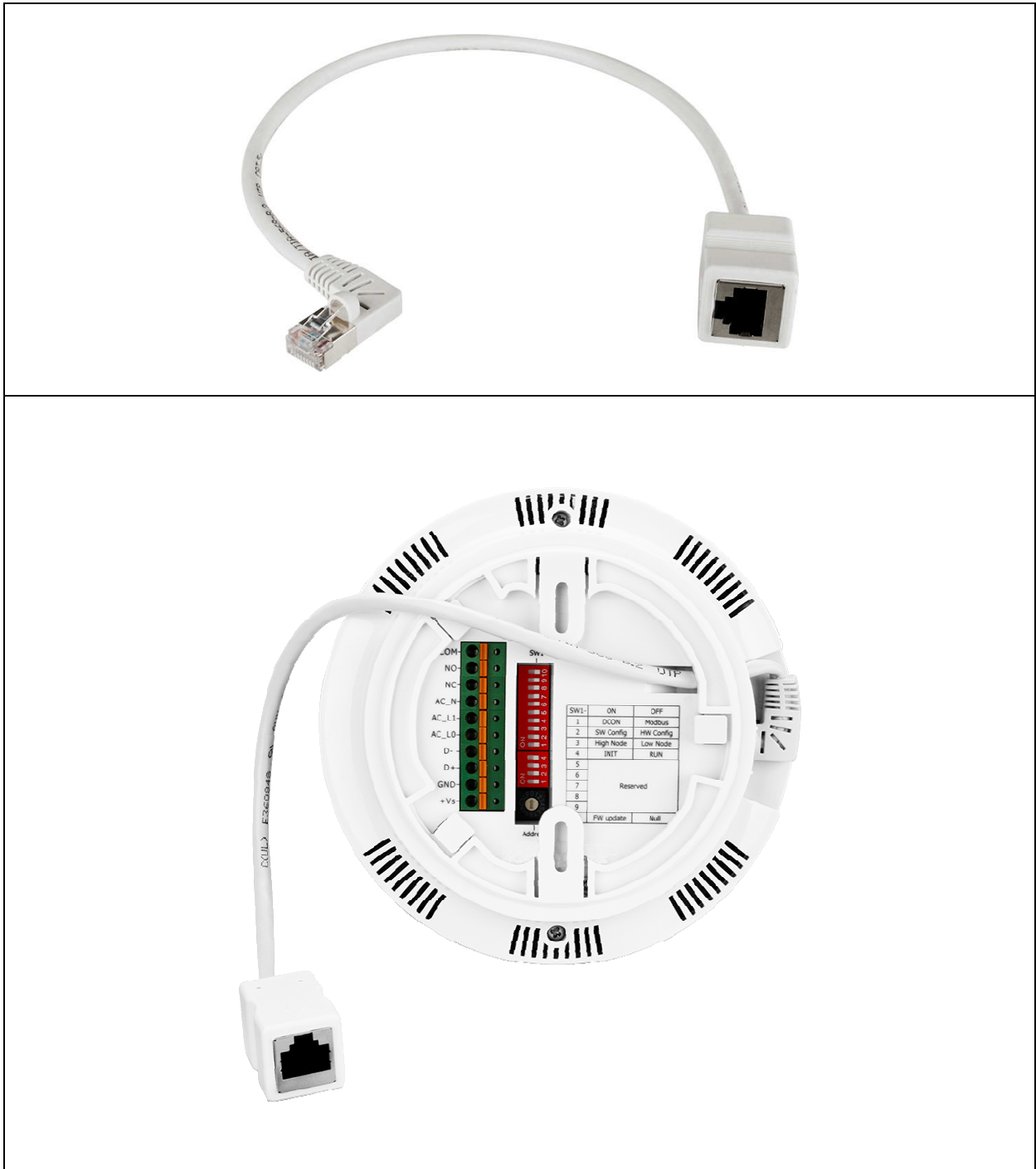

Replaceable Filter Patch:

CL-21x Series offers a replaceable filter patch on the back of the hood filter. This mechanism makes users to replace only the filter patch rather than uninstall all devices.

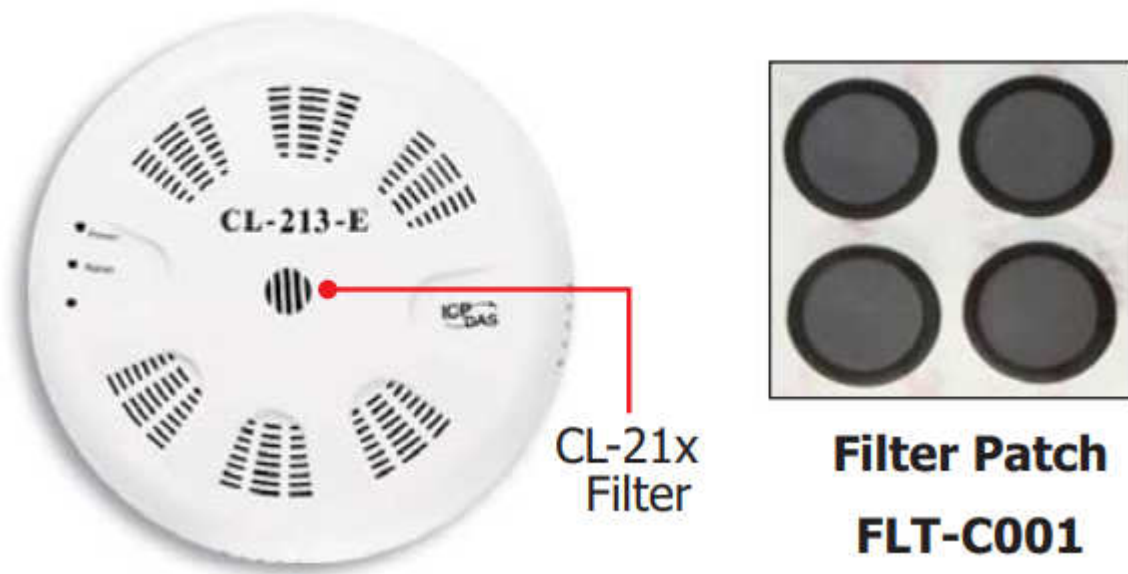

3. Configuration via Web Browser

CL-200 logger has a built-in web server that provides simple web pages for remote monitoring real-time data and configuring the logger with a standard browser. For opening the web page in CL-200, the factory default IP address (192.168.255.1), Subnet Mask (255.255.0.0) and Gateway (192.168.0.1) need be set to available IP/Subnet Mask/Gateway addresses in your Ethernet environment. The Ethernet configuration can be set by entering the Settings menu from the web pages. Please note that the web configuration is only available to the Ethernet interface.

3.1 Search the CL-200 logger

eSearch is designed to search out the CL-200 logger connected on the same Ethernet network, it supports for Linux and Windows and is needless to install. Please note that the eSearch Utility cannot be used to configure CL-200-WF device via the Wi-Fi interface. In this case, use the Wi-Fi IIOT Utility instead.

The eSearch can be downloaded from

<http://ftp.icpdas.com/pub/cd/iiot/utility/>

Before running eSearch, turn off firewall on computer, and connect the computer and CL-200 logger to Ethernet network.

1. Launch eSearch, click the **Search Servers** button to search the CL-200 modules connected to the network, the modules searched out will be listed as below.
2. Double click the module name searched in the list.

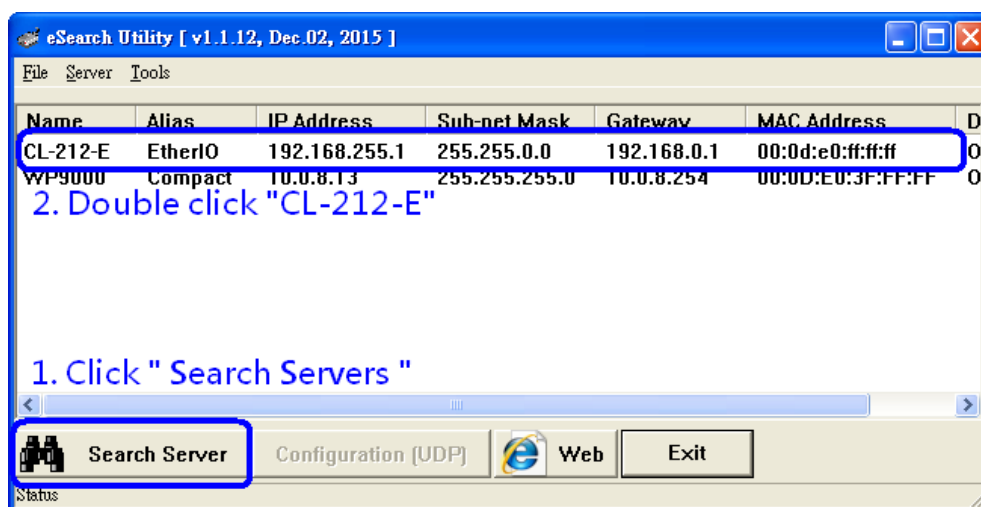

3. Set available IP Address, Sub-net Mask, Gateway (designated by your network administrator) and alias and click the **OK** button. The Alias for easy to identify each item will be shown at the bottom-left corner of the CL-200 screen.

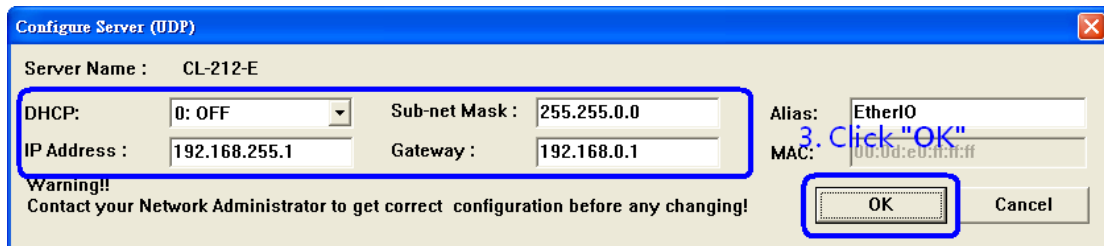

3.2 Logging into the CL-200

1. Enter the IP address for your CL-200 in the address bar of a web browser. (sec. 3.1).
2. Type the Login password, and click the **Submit** button.
(The default Login password is **Admin**, case sensitive.)



3.3 Home

The first page displayed is **Home**, it shows the based configuration of the CL-200 module and the real-time data as below:



CL-212-E PM2.5, CO₂, Relative Humidity and Temperature Data Logger

[Home](#) | [Network](#) | [I/O Settings](#) | [MQTT](#) | [Filter](#) | [Monitor](#) | [Change Password](#) | [Logout](#)

Model Name:	CL-212-E	Alias Name:	EtherIO
Firmware Version:	B3.3 [Jul.7, 2017]	MAC Address:	00-0D-E0-FF-FF-FF
IP Address:	10.0.8.112	Initial Switch:	ON
TCP Port Timeout (Socket Watchdog, Seconds):	180	System Timeout (Network Watchdog, Seconds)	0

Sensor Readings

Type	Value	Low Latched	High Latched
CO ₂	0 ppm	50000 ppm	-1 ppm
PM2.5	0 ug/m ³	20000 ug/m ³	-20000 ug/m ³
Relative Humidity	55.5%	54.5%	64.4%
Temperature	26.2 °C	24.3 °C	26.4 °C
Dew Point	16.6 °C	15.8 °C	17.7 °C

In the **Sensor Readings** field is the real-time data of PM2.5/O₂/CO/CO₂/NH₃/H₂S /HCHO/TVOC concentration, temperature, humidity and dew point, the minimum value (Low Latched) and maximum value (High Latched) logged. Clicking on the **Clear Low Latched** button and the **Clear High Latched** button can reset the latched data to current value and latch new minimum or maximum value.

Alarm

Type	Alarm Mode	Low Alarm Limit	High Alarm Limit	Low Alarm Status	High Alarm Status
CO ₂	Disabled		1000 ppm		Off
PM2.5	Disabled		100 ug/m ³		Off
Relative Humidity	Disabled	0.0%	100.0%	Off	Off
Temperature	Disabled	-50.0 °C	100.0 °C	Off	Off
Dew Point	Disabled	-50.0 °C	100.0 °C	Off	Off

The Alarm table displays the settings of alarm mode, high alarm limit for PM2.5/O₂/CO/CO₂/NH₃/H₂S/HCHO/TVOC concentration, temperature, humidity and dew point, low alarm limit for temperature, humidity and dew point, and the alarm status for each. Clicking on the **Clear Latched Alarm** button can clear the activated alarm status.

Digital Output

Channel	State	Action
D00	Off	OFF <input checked="" type="radio"/> ON <input type="radio"/>

The **Digital Output** table shows the status of the relay output and the control button **Set Digital Output** to change the relay output status. The control function is invalid when any of the alarm modes is not disabled. If one of the alarm modes is enabled, the relay is linked to the alarm status for tapping audible/visual alarm.

At the end of the page are the data, time and device online time since powered on.

RTC

Date	2014-08-25	Time	09:20:51
------	------------	------	----------

Device Online Time

Device Online Time	0 Days, 00H:31M:13S
--------------------	---------------------

3.4 Network

The networks parameters are set on this page including DHCP enabled/disabled, IP/Subnet Mask/Gateway addresses, the port number and the NetID for Modbus TCP communication. Remember to click on the **Update Settings** button to update new parameters.

IP Address Configuration

IP Address	
Address Type	Static IP ▼
Static IP Address	10 . 0 . 8 . 112
Subnet Mask	255 . 255 . 0 . 0
Default Gateway	10 . 0 . 8 . 254
MAC Address	00-00-E0-FF-FF-FF (Format: FF-FF-FF-FF-FF-FF)
Modbus TCP Slave	
Local Modbus TCP port	502 (Default= 502)
Local Modbus NetID	1 (Default= 1) Enable ▼ (Default= Enable)
<input type="button" value="Update Settings"/>	

General Settings

Ethernet Speed	Auto (Auto=10/100 Mbps Auto-negotiation)
System Timeout (Network Watchdog)	0 (30 ~ 65535 s, Default= 0, Disable= 0) Action:Reboot
TCP Timeout	180 (5 ~ 65535 s, Default= 180, Disable= 0) Action:Cut-off
UDP Configuration	Enable (Enable/Disable the UDP Configuration, Enable=default.)
Web Auto-logout	10 (1 ~ 65535 minutes, Default= 10, Disable= 0)
Alias Name	EtherIO (Max. 30 chars, part of the MQTT topic name)
<input type="button" value="Update Settings"/>	

Item	Description	Default
System Timeout (Network Watchdog)	<p>Sets the timeout for rebooting a CL-200 logger when it is abnormal or failure to communicate.</p> <p>Range: 30 ~ 65535 (unit: second) 0 = Disable</p>	0 (Disable)
TCP Timeout	<p>Sets the timeout for disconnecting a TCP connection when a CL-200 does not receive data coming from the Ethernet port.</p> <p>Range: 5 ~ 65535 (unit: second) 0 = Disable</p>	180
Web Auto-logout	<p>Sets the timeout for logout the web server in a logger when there is no any operation from the web browser interface.</p> <p>Range: 1 ~ 65535 (unit: minute) 0 = Disable</p>	10
Alias Name	<p>Sets an alias name for easy to identify a CL-200. The maximum length is 18 characters.</p>	EtherIO

Restore Factory Defaults

Restore all options to their factory default states	Restore Defaults
Forced Reboot	Reboot

The **Reboot** button is used to reboot the CL-200. After pressing the button, a user needs to login the CL-200 logger again to using the web interface.

The **Restore Defaults** button can be used to restore the following settings to factory default values.

Item	Factory Default
IP address type	Static IP
Static IP	192.168.255.1
Default gateway	192.168.0.1
Subnet Mask	255.255.0.0
MAC address	Factory MAC address
Modbus TCP port	502
Modbus TCP NetID	1
Modbus TCP NetID	Enabled
System Timeout	0 (disabled)
TCP Timeout	180 seconds
Web auto logout	10 minutes
Alias name	EtherIO
Accessible IP	Disabled

Firmware Update

<p>If the remote firmware update is failed, then the traditional firmware update (on-site) is required to make the module working again.</p> <p>Step 1: Refer to firmware update manual first. Step 2: Run eSearch Utility to prepare and wait for update. Step 3: Click the [Update] button to reboot the module and start update. Step 4: Configure the module again.</p>	Update
---	--------

The **Update** button is used to update firmware. Please Refer to firmware update manual first.

3.5 MQTT

MQTT stands for MQ Telemetry Transport, it is a publish/subscribe, extremely simple and lightweight messaging protocol, designed for constrained devices and low-bandwidth, high-latency or unreliable networks.

The Publish-Subscribe messaging pattern requires a message broker. The broker is responsible for distributing messages to interested clients based on the topic of a message. Now the MQTT Version 3.1.1 becomes an OASIS standard, it is an ideal protocol for communicating with connected devices in the emerging "machine-to-machine" (M2M) and "Internet of Things" applications, and for mobile applications where bandwidth and battery power are at a premium.

Connectivity Settings

MQTT	Disable ▾		
Broker IP Address	192	. 168	. 255 . 10
Broker Port	1883 (Default= 1883)		
Client Identifier	CL-212-E_FFFFFFFF		
Alias Name	EtherIO (Max. 30 chars, part of the topic name)		
User Name			
Password			
Reconnection Interval	10 (5 ~ 65535 s, Default= 10)		
Keep Alive Interval	20 (5 ~ 65535 s, Default= 20)		
<input type="button" value="Update Settings"/>			

Input the IP address and port number for the MQTT broker and click on the **Update Settings** button to save the parameters.

Last Will Settings

Last Will and Testament	<input type="checkbox"/>
Topic	<input type="text"/> (Max. 30 chars)
Message	<input type="text"/> (Max. 30 chars)
QoS	0 - At most once ▾
Retained	<input type="checkbox"/>
<input type="button" value="Update Settings"/>	

The MQTT Last Will and Testament (LWT) feature is used to notify other clients about an ungracefully disconnected client. A CL-200-E can register an offline message (LWT) to the broker. The LWT message will be delivered to all clients who subscribe to the offline topic if the CL-200-E disconnects unexpectedly.

Publication Settings

Cycle	1000	(400 ~ 65500 ms, in 10 ms step, Default= 1000)
Publication Topic Format	(Module Topic Name)(Sub Topic Name) ▾	
Module Topic Name	EtherIO/	(Max. 255 chars)
CO ₂ Sub Topic Name	CO2	(Max. 63 chars) Enable ▾
PM2.5 Sub Topic Name	PM25	(Max. 63 chars) Enable ▾
Relative Humidity Sub Topic Name	RH	(Max. 63 chars) Enable ▾
Temperature (°C) Sub Topic Name	TC	(Max. 63 chars) Enable ▾
Temperature (°F) Sub Topic Name	TF	(Max. 63 chars) Enable ▾
Dew Point (°C) Sub Topic Name	DC	(Max. 63 chars) Enable ▾
Dew Point (°F) Sub Topic Name	DF	(Max. 63 chars) Enable ▾
All Information Sub Topic Name	Info	(Max. 63 chars) Disable ▾
Update Settings		

- Cycle: sets the time period for update the publish messages in millisecond.
- Module Topic Name: sets the module topic name.
- PM2.5/O₂/CO/CO₂/NH₃/H₂S/HCHO/TVOC/Relative Humidity/Temperature (°C)/ Temperature (°F)/ Dew Point (°C)/ Dew Point (°F) Sub Topic Name: sets the sub topic name for each item.

A MQTT client subscribes the messages form a MQTT broker by specifying the topic name as

Module Topic Name + Sub Topic Name

For example, to subscribe the CO₂ level in this case, a MQTT client subscribes the topic name from a MQTT broker as

EtherIO/CO₂

Subscription Settings

Subscription Topic Format	(Module Topic Name)(Sub Topic Name) ▾	
DO0 Sub Topic Name	DO	(Max. 63 chars)
Update Settings		

If a MQTT control message is published to topic name: “Module Topic Name + DO0 Sub Topic Name ” for a CL-200 logger, the logger will follow the MQTT message described to set the Relay Output.

3.6 I/O Settings

Temperature

Scale	°C ▼
<input type="button" value="Update Settings"/>	

Users can change the temperature unit to Fahrenheit or Celsius in this field.

CO₂ Automatic Baseline Correction

Mode	Disabled ▼
<input type="button" value="Update Settings"/>	

To Enable/Disable the CO₂ Automatic Baseline Correction function.

Q & A

Q: What is ABC (Automatic Baseline Correction)?

A: ABC stands for the Automatic Baseline Correction which is used to adjust a shifted baseline to the carbon dioxide level in fresh air. In case of normal indoor application, the carbon dioxide level drops to nearly outside air where there are no human, green plants or anything to elevate the carbon dioxide levels on weekday evenings or weekends, the ABC algorithm constantly keeps track of the lowest reading and slowly corrects it as the expected value in fresh air typically around 400 ppm.

Q: Why I need to enable the ABC?

A: When the CO₂ concentration detected in a period time of unoccupied space is greater than the base value of 400ppm, enable the ABC function to adjust the baseline. Be careful that the ABC will not work if a space is constantly occupied such as a hospital, 24-hr factory, 24-hr store, green house or other applications where CO₂ levels may be elevated at all times.

Alarm Configuration

Type	Alarm Mode	Low Alarm Limit	High Alarm Limit	Beep On Alarm
CO ₂	Disabled ▾		1000	Enabled ▾
PM2.5	Disabled ▾		100	Enabled ▾
Relative Humidity	Disabled ▾	0.0	100.0	Disabled ▾
Temperature	Disabled ▾	-50.0	100.0	Disabled ▾
Dew Point	Disabled ▾	-50.0	100.0	Disabled ▾
Beep On Alarm Time	30 (0: beep off, 1 to 250: beep on alarm time in seconds, 251: beep on alarm continuously)			
Update Settings				

All the settings take effect after clicking the *Update Settings* button.

Item	Description	Default
Alarm Mode	<p>- Disabled: Disables alarm function.</p> <p>- Momentary: If a measurement value higher than the High Alarm Limit or lower than the Low Alarm Limit, the alarm occurs until the measurement value is within a range from Low Alarm Limit to High Alarm Limit. (For CO/CO₂ level, until the measurement value is lower than the High Alarm Limit.) The Alarm LED turns red, and the relay turns to on for every alarm event, and a sound alarm beeps as the setting in <i>Beep on Alarm Time</i> for CO/CO₂ high limit alarm events during the alarm stage.</p> <p>- Latched: If a measurement value higher than the High Alarm Limit or lower than the Low Alarm Limit, the alarm occurs. The Alarm LED turns red, the relay turns to on for every alarm event, and a sound alarm beeps as the setting in <i>Beep on Alarm Time</i> for CO/CO₂ high limit alarm events. Even though the alarm event is not presented, the alarm status is latched; the Alarm LED keeps red, and the relay keeps on and the sound alarm keeps beeping if it is set to beeping continuously.</p>	Disabled
Low Alarm Limit	Sets the Low alarm limit conditions for Relative Humidity/ Temperature/ Dew Point.	
High Alarm	Sets the High alarm limit conditions for CO/CO ₂ /Relative	

Limit	Humidity/ Temperature/ Dew Point.	
Beep On Alarm	Enable/disable beep on alarm for PM2.5 /CO /CO ₂ /Temp /RH /Dew point	
Beep On Alarm Time	Sets the time for beeping alarm. Range: 1 ~ 250 (unit: second) 0 = disable the beeping alarm 251 = continue the beeping alarm without stop	30

Digital Output

Channel	Power On Value	Safe Value
DO0	Off ▼	Off ▼
Host Watchdog Timeout (seconds)	0 (5 to 65535 Seconds, Default= 0, Disable= 0)	
Update Settings		

Set the *Power On Value* and *Safe Value* for the relay output, and the *Host Watchdog Timeout* timer for RS-485 communication; if a host does not send a command over the setting time, the Host Watchdog timeout occurs and the relay outputs the status set for Safe value. The settings for Power On Value and Safe Value are unavailable when any one setting in the *Alarm Mode* is enabled.

RTC

Year	2015 (2000 to 2159)
Month	8 (1 to 12)
Date	6 (1 to 31)
Hour	17 (0 to 23)
Minute	29 (0 to 59)
Second	7 (0 to 59)
Update Settings	

All the settings take effect after clicking the *Update Settings* button.

Data Logger

Status	Running	
Change Logging	Run	▼
Overwrite on Full	No	▼
Sampling Interval - Hour	0	(0 to 24)
Sampling Interval - Minute	6	(0 to 59)
Sampling Interval - Second	0	(0 to 59)
Period Start - Year	2014	(2000 to 2159)
Period Start - Month	6	(1 to 12)
Period Start - Date	1	(1 to 31)
Period Start - Hour	0	(0 to 23)
Period Start - Minute	0	(0 to 59)
Period Start - Second	0	(0 to 59)
Period End - Year	2014	(2000 to 2159)
Period End - Month	6	(1 to 12)
Period End - Date	2	(1 to 31)
Period End - Hour	0	(0 to 23)
Period End - Minute	0	(0 to 59)
Period End - Second	0	(0 to 59)
Update Settings		

In this table it shows the settings for data logger.

All the settings take effect after clicking the *Update Settings* button.

Item	Description	Default
Status	<ul style="list-style-type: none"> - Running: the data logger is running - Stopped: the data logger is stopped 	
Change Logging	Sets the mode for data logger <ul style="list-style-type: none"> - Stop: stops the data logger - Run: continues logging data - Period: logs data in the specified period time 	Stop

Overwrite on Full	Sets whether to overwrite old data by new ones when the memory for data storage is full. (Over the upper limit of 450,000.) - No: discards the new data (default) - Yes: overwrites the old data by new ones	No
Sampling Interval	Sets the time interval for logging data. It is valid for both Run mode and Period mode. - Sampling Interval – Hour: sets the hour for log interval - Sampling Interval – Minute: set the minute for log interval - Sampling Interval – Second: sets the second for log interval	10 (s)
Period Start	Sets the start time for Period mode.	
Period End	Sets the stop time for Period mode	



Click the *Reset Data Logger* button to clear the data in data storage memory.

3.7 Filter IP

For limiting the devices to access the CL-200 logger, users can specify particular devices by setting their IP addresses on this page. When the addresses are 0.0.0.0 from IP1 to IP5, all the devices can access the logger. Once any of the 5 IP address columns is set, only the device with which IP is saved in the list can access the logger.

➤ Filter Settings

1. Select the radio button for *Add ____ . ____ . ____ . ____ To The List* and type the IP address for the accessible device in the following text box.
2. Click on the *Submit* button to the setting effect without restarting.
If the IP setting needs be saved for using after repowered, check the checkbox for *Save to Flash* before clicking the *Submit* button.

Filter Settings:

Available IP List	IP Address
IP1:	0.0.0.0
IP2:	0.0.0.0
IP3:	0.0.0.0
IP4:	0.0.0.0
IP5:	0.0.0.0

Add . . . To The List

Delete IP#

Delete ALL

Save to Flash

➤ Delete IP setting

Select the radio button for *Delete IP#* to delete a specified IP or the radio button for *Delete All* to delete all the IP, check the checkbox for *Save to Flash* and then click the *Submit* button to take the delete operation effect.

3.8 Change Password

On this page users can change the passwords for login the logger and locking the touch screen. The factory default for the CL-200 touch screen has no password protection. After setting the password for touch screen, each time whoever wants to change to settings from the touch screed, the password will be requested.

➤ Change Web Password

The password for logging into the web page is **Admin** and can be changed in the *Change Web Password* field. The password can be alphabetic characters or numbers and up to 12 characters (case sensitive).

To change the password, uses need enter the *Current password*, *New password*, and *Confirm new password* columns and click the Submit button for Change Web Password to take the setting effect.

Change Password

The length of the password is 12 characters maximum.

Current password:	<input type="text"/>
New password:	<input type="text"/>
Confirm new password:	<input type="text"/>
	<input type="submit" value="Submit"/>

3.9 Logout

Click the Logout on any page to logout the CL-200.

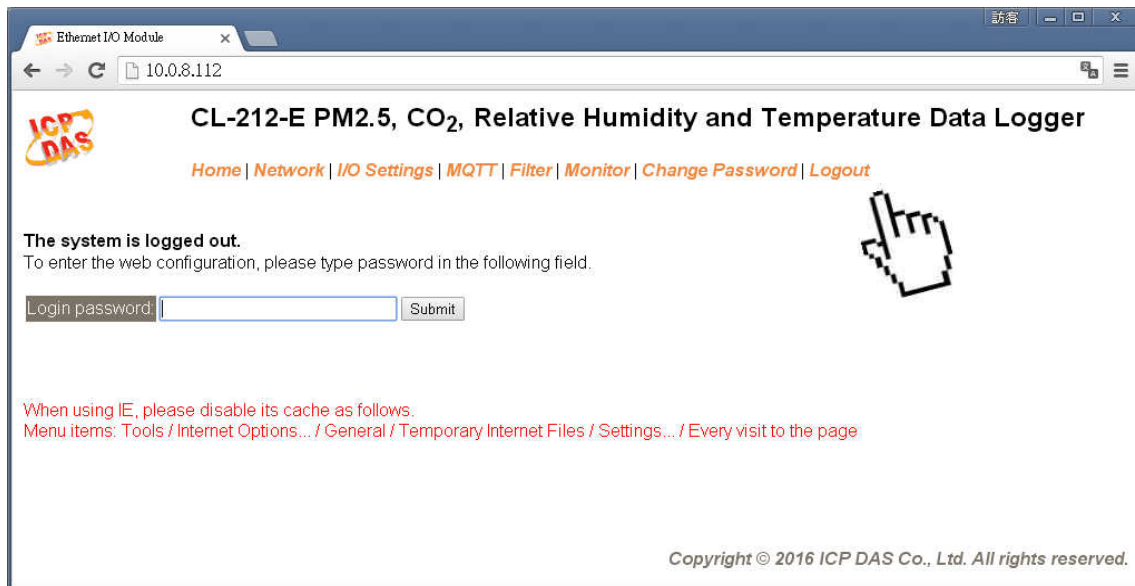

3.10 Wi-Fi

For CL-200-WF module, the Wi-Fi related parameters can be set via the Wi-Fi page. This page including Wi-Fi Status and Wi-Fi Settings, each of which will be described in more detail below.

➤ **Wi-Fi Status**

Wi-Fi Status

Connection Status	Connected
Signal Strength	High
MAC Address	D0-5F-B8-1C-0C-56
IP Address	192.168.0.100

Update Wi-Fi Status

The following table provides an overview of the parameters contained in the Wi-Fi Status section:

Item	Description
Connection Status	The Wi-Fi connection status of the CL-200-WF device.
Signal Strength	The Wi-Fi signal strength of the CL-200-WF device in station mode. It can be High, Medium, Low, or Not Connected.
MAC Address	The MAC address of the Wi-Fi interface of the CL-200-WF device.
IP Address	The IP address of the Wi-Fi interface of the CL-200-WF device.
Update Wi-Fi Status	Click this button to update the Wi-Fi status of the CL-200-WF device.

➤ Wi-Fi Settings

Wi-Fi Settings

Wi-Fi Settings	Current	New
Mode	Station	Station <input type="button" value="v"/> Default: AP
Wireless Security	WPA/WPA2, *****	WPA/WPA2 <input type="button" value="v"/> Password: <input type="password" value="....."/> (Max. 63 chars)
DHCP Server (AP Mode)	On, 192.168.255.2	On <input type="button" value="v"/> Start IP: <input type="text" value="192"/> . <input type="text" value="168"/> . <input type="text" value="255"/> . <input type="text" value="2"/>
Wi-Fi Channel (AP Mode)	11	11 <input type="button" value="v"/>
IP Address Type (Station Mode)	DHCP	DHCP <input type="button" value="v"/>
IP Address	192.168.0.100	<input type="text" value="192"/> . <input type="text" value="168"/> . <input type="text" value="255"/> . <input type="text" value="1"/>
Subnet Mask	0.0.0.0	<input type="text" value="255"/> . <input type="text" value="255"/> . <input type="text" value="0"/> . <input type="text" value="0"/>
Gateway	192.168.0.1	<input type="text" value="192"/> . <input type="text" value="168"/> . <input type="text" value="255"/> . <input type="text" value="254"/>
SSID	WR841NV13	WR841NV13 (Max. 32 chars)
Modbus TCP port	502	<input type="text" value="502"/> (Default= 502)
<input type="button" value="Update Settings"/>		

The column of Current shows the current Wi-Fi settings. You can change the settings by changing the column of New. The following table provides an overview of the parameters contained in the Wi-Fi Settings section:

Item	Description
Mode	This parameter is used to specify the Wi-Fi mode of the CL-200-WF device. It can be station or AP. For AP mode, only one device can be connected.
Wireless Security	This parameter is used to specify which security protocol is used to secure wireless computer network. It can be open, WEP, or WPA/WPA2. It is recommended to use WPA/WPA2 if possible.
DHCP Server (AP Mode)	This parameter is used to specify whether to turn on the DHCP server function. It is only available to the AP mode.
Wi-Fi Channel (AP Mode)	This parameter is used to specify which channel is used for Wi-Fi transmission. It can be 1 to 11. It is only available to the AP mode.
IP Address Type (Station Mode)	This parameter is only available to the station mode and it can be Static IP or DHCP. If DHCP is supported by the AP you would like to connect, then DHCP should be selected. Otherwise, select Static IP and the following three parameters IP Address, Subnet Mask and Gateway should be set, too.

IP Address	Each CL-200-WF device connected to the Wi-Fi network must have its own unique IP address. This parameter is used to assign a specific IP address.
Subnet Mask	This parameter is used to assign the subnet mask for the CL-200-WF device. The subnet mask indicates which portion of the IP address is used to identify the local network or subnet.
Gateway	This parameter is used to assign the IP address of the gateway to be used by the CL-200-WF device. A gateway (or router) is a device that is used to connect an individual network to one or more additional networks.
SSID	This parameter is used to specify the Service Set Identifier. For station mode, specify the SSID of the AP you would like to connect. For AP mode, the SSID will be used by the device to be connected.
Modbus TCP Port	This parameter is used to set the local port of the Wi-Fi interface to be used by the Modbus slave device. The default value is 502.
Update Settings	Click this button to save the revised settings to the CL-200-WF device.

The following table provides an overview of the factory default Wi-Fi settings:

Factory Default Wi-Fi Settings	
Mode	AP
Wireless Security	WPA/WPA2, "00000000"
DHCP Server (AP Mode)	DHCP Server on, start IP: 192.168.255.2
Wi-Fi Channel (AP Mode)	11
IP Address	192.168.255.1
Gateway Address	192.168.255.254
Subnet Mask	255.255.0.0
SSID	CL-200-WF
Modbus TCP Port	502

4. Configuration via RS-485

- The factory default settings for RS-485 communication
 - Address: 192
 - Protocol: Modbus/RTU
 - Baudrate: 9600
 - Parity: N,8,1
 - Response Delay (ms): 0

Note

If there are multiple CL-200 loggers connected to the same RS-485 network, each logger needs to be set with a unique RS-485 address. More than one module having the same address will cause communication failure

- Testing RS-485 Communication
 1. Download the DCON Utility Pro from <http://ftp.icpdas.com/pub/cd/iiot/utility/>
 2. Launch the DCON_Utility_Pro.exe.

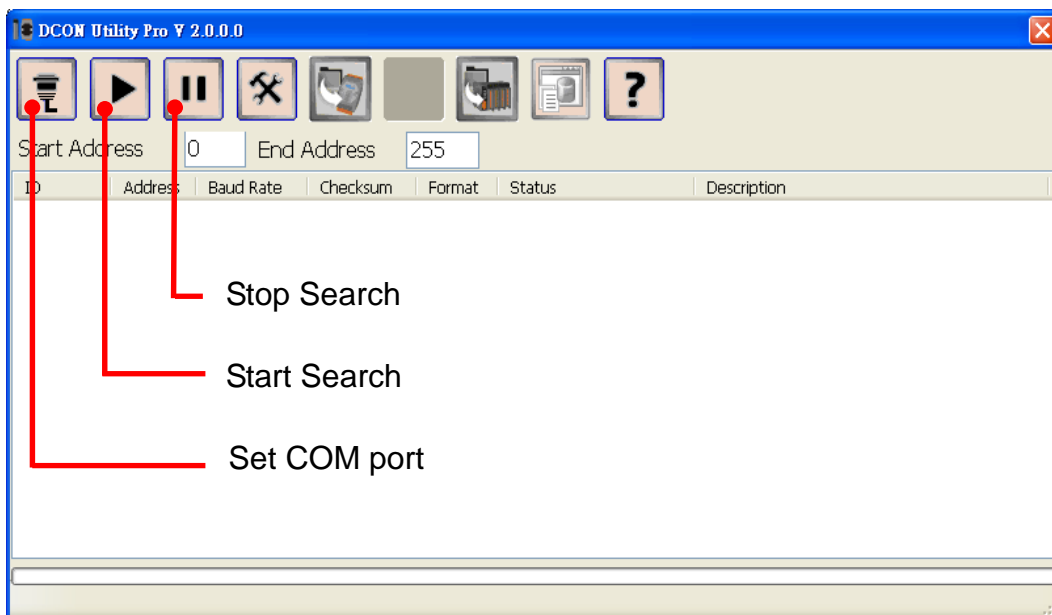

3. Click the icon  to configure the COM port.

4. Select the COM Port number used to connect the CL-200 logger.

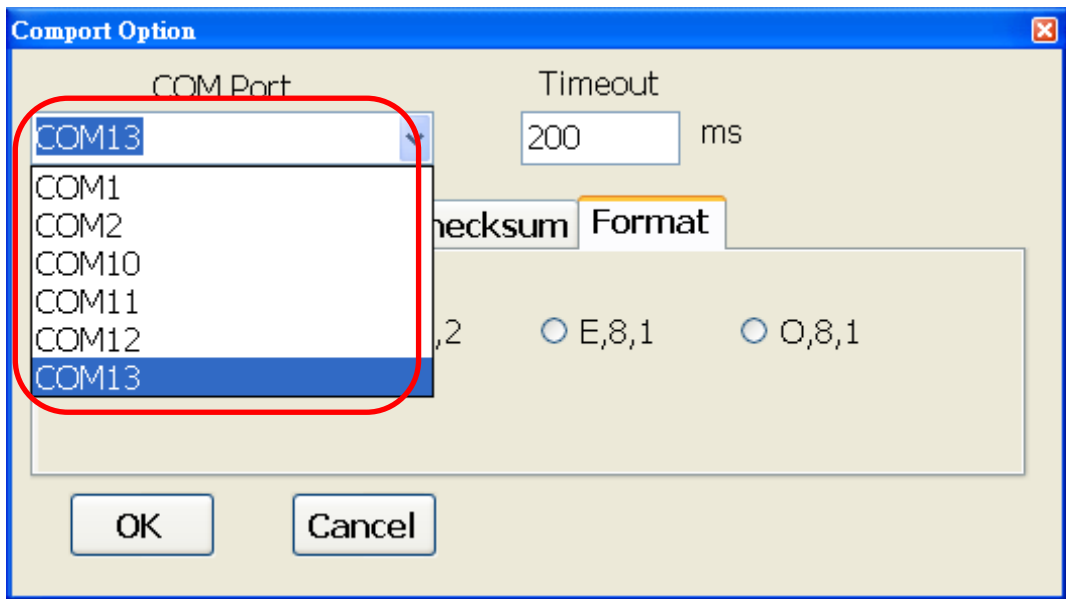

5. The Baud Rate is factory default to 9600 bps.

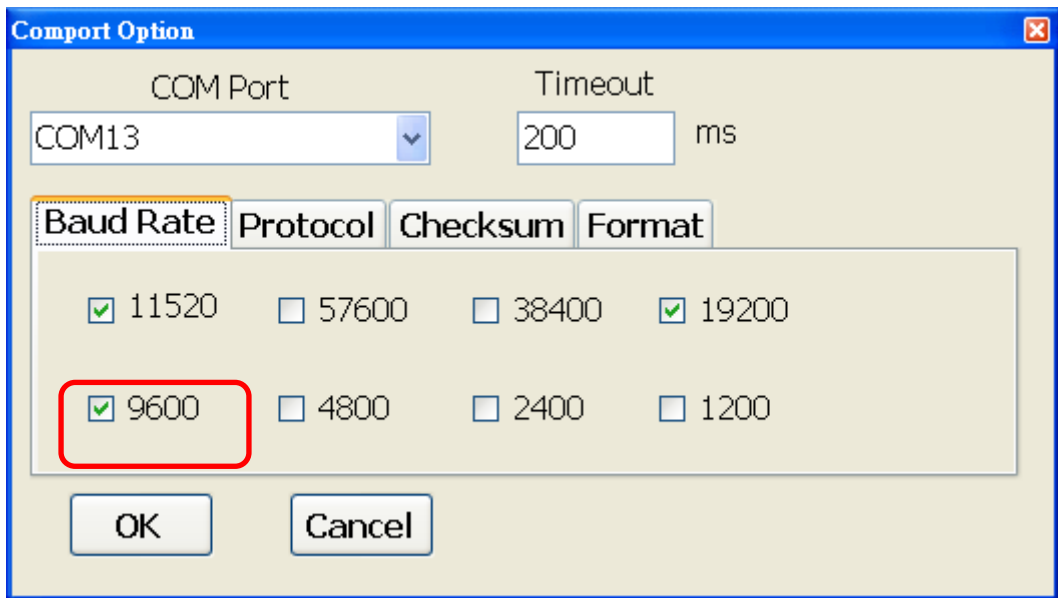

6. Select the Protocol tab and check the protocol that set in the logger.

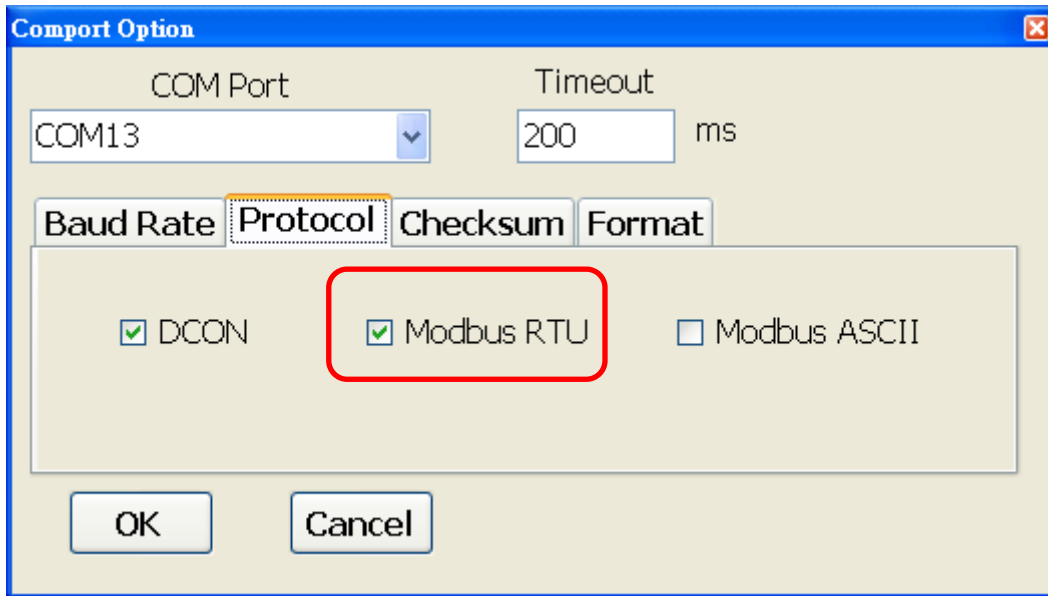

7. Select the Format tab and check the parity that set in the logger.

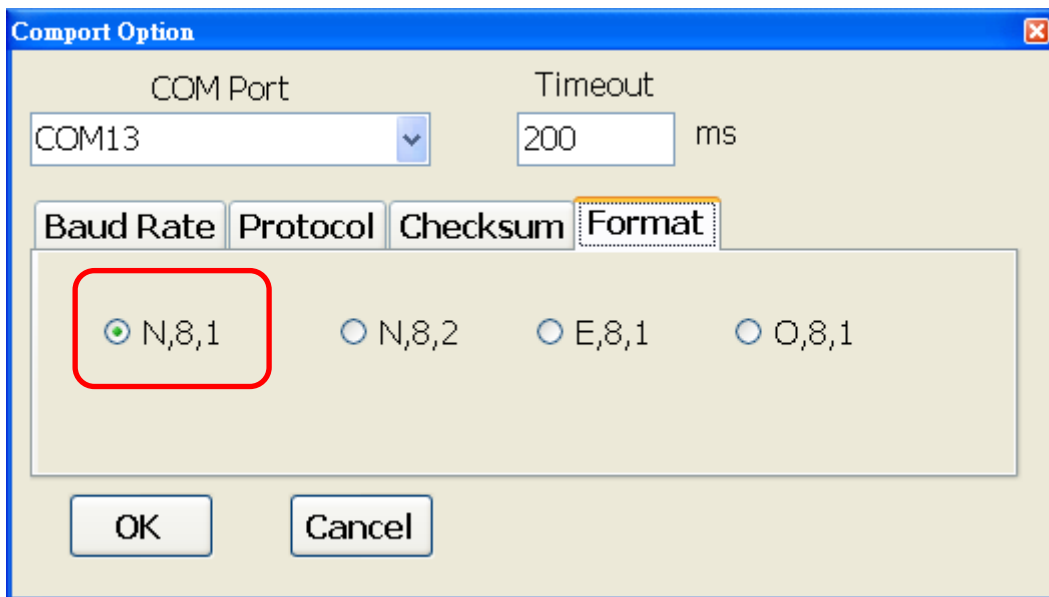

8. Click the Start Search icon.



9. The CL-200 logger searched out will be listed as below.

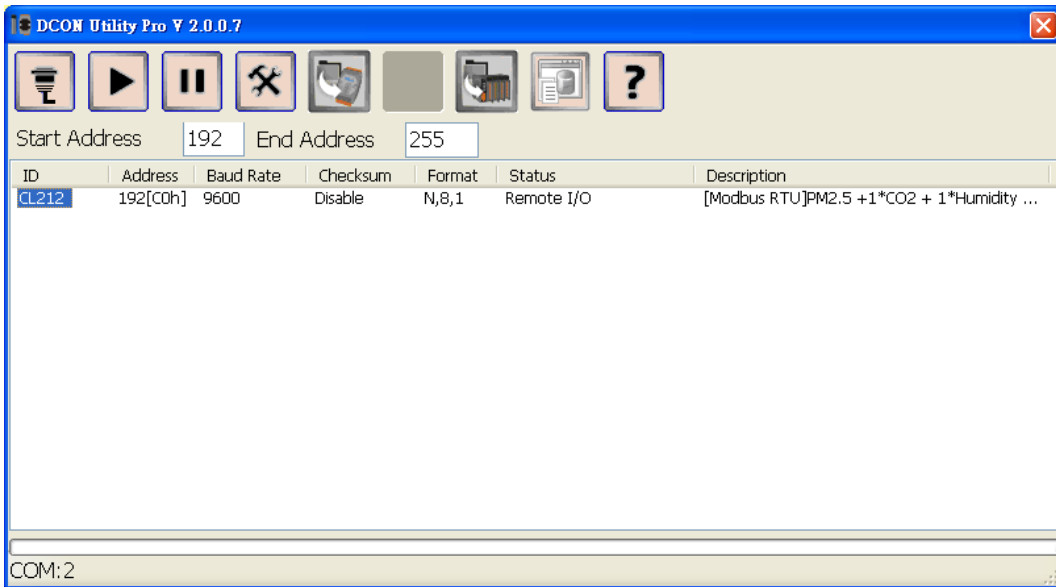

10. Click the module name to configure the logger.

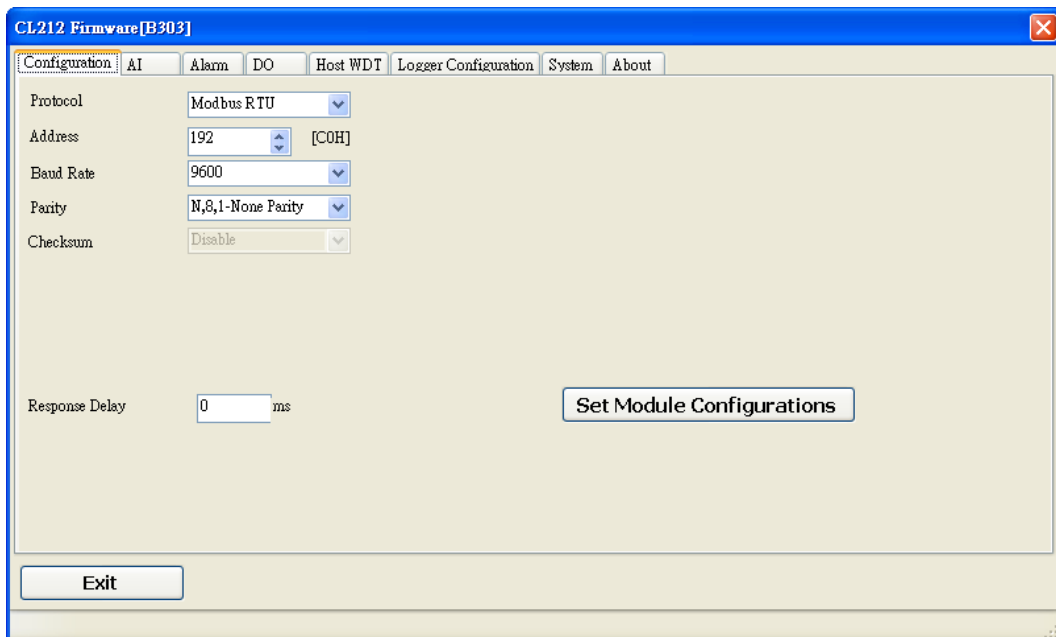

Note

The Protocol/Baud Rate/Parity/Checksum items marked with "(INIT*)" means that when any of those items needs be modified, the pin 4.INIT needs to be set in ON position and power cycle the logger, then the item can be modified. After complete setting, set the pin 4.INIT back to OFF position and power cycle the logger again to take the setting effect.

➤ **AI tab**

PM2.5/CO₂
level

Degree of offset

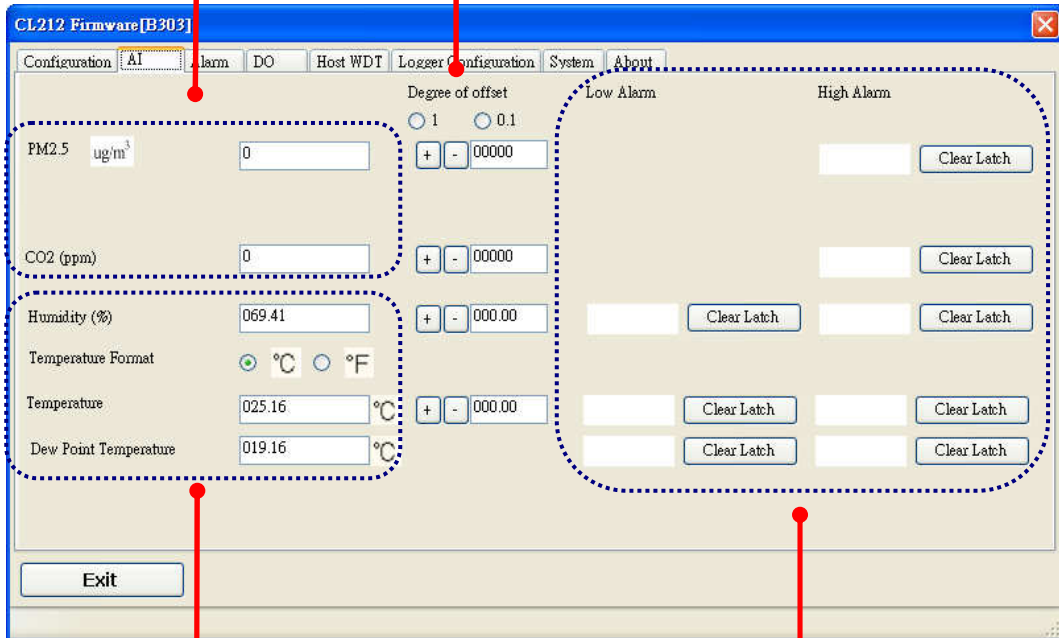

Humidity, Temperature and
Dew point temperature

Clear High/Low
Alarm Latch

➤ Alarm tab

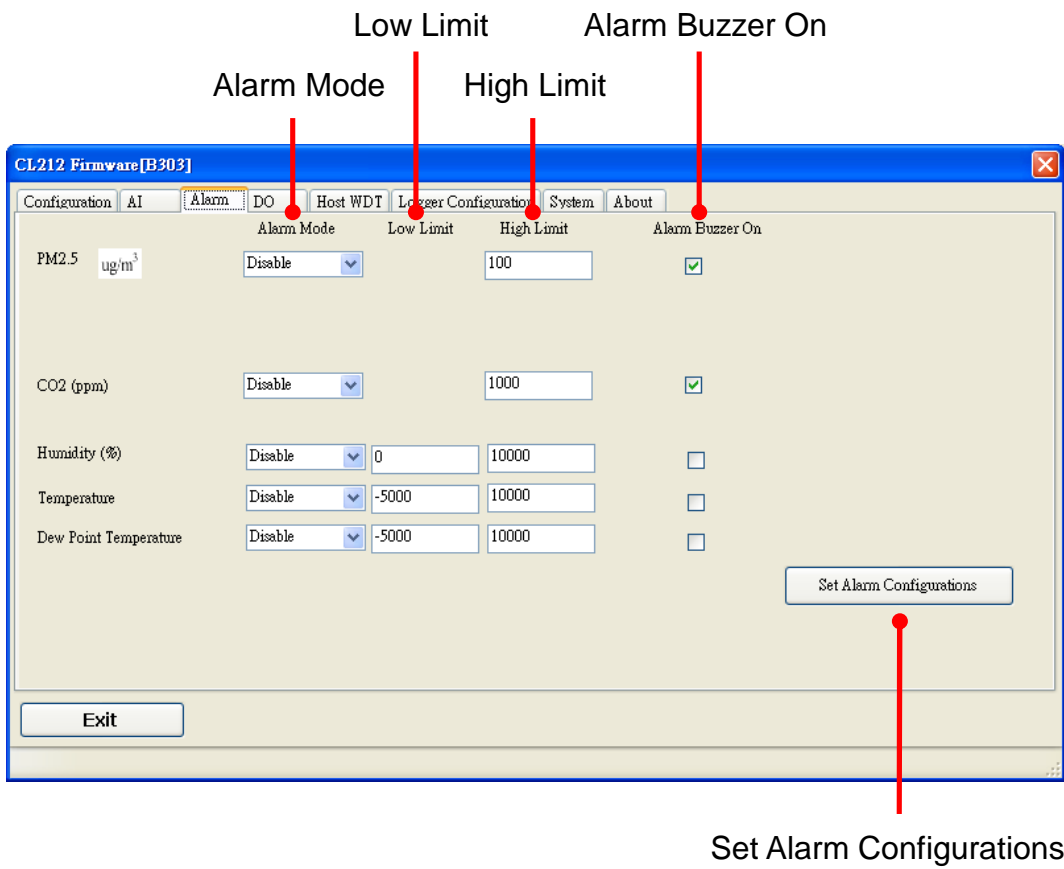

➤ **DO tab**

On this DO tab, users can control the relay to output ON or OFF status, and set the power on value and safe value for the relay output.

When any one of the high/low limit alarm for CO/CO₂ concentration, temperature, humidity and dew point is enabled, the functions on this tab are all disabled as below.

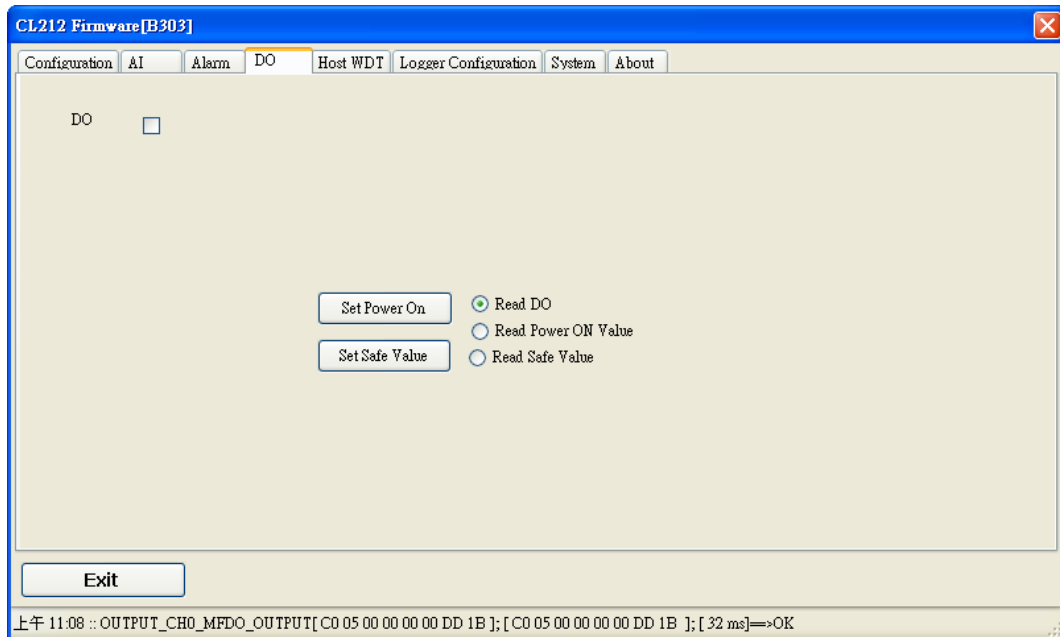

If all the alarm events are disabled, the functions are available as below:

The checkbox can be used to control and display the DO status.
Check/Uncheck the checkbox can control the relay output.
Checked/Unchecked symbol also means the DO status

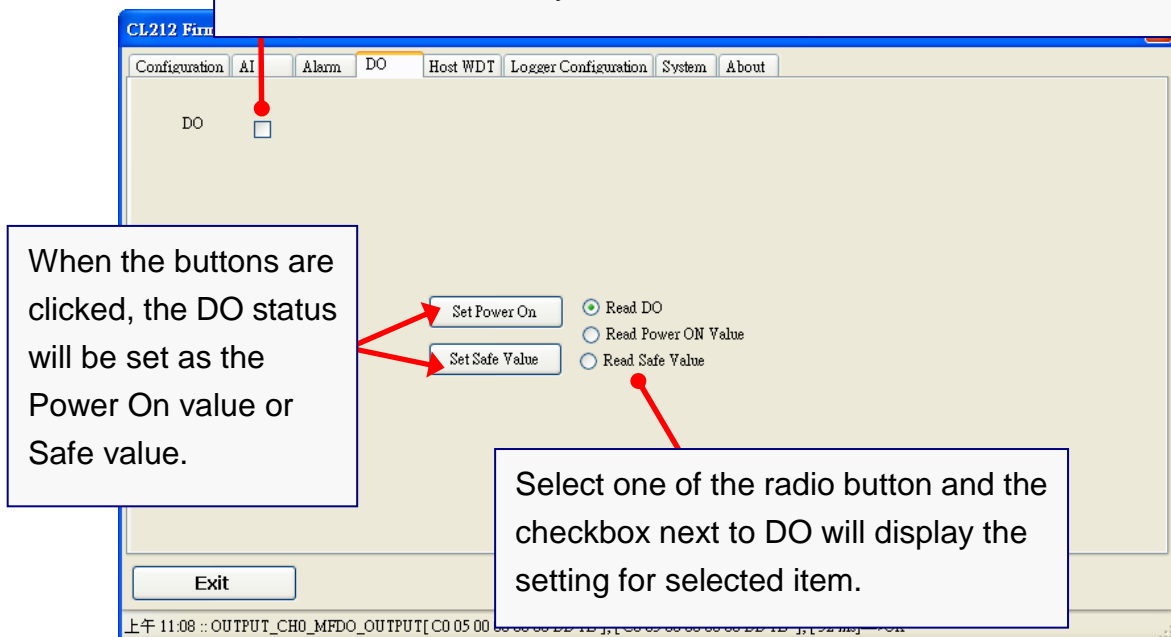

➤ Host Watchdog

Host Watchdog is used to monitor the RS-485 communication status; if the host (PC) does not send command “~**” in the time period of WDT Timeout setting, the enabled Host Watchdog will announce the timeout error and turn the relay output to Safe value to avoid an unsafe act. Users can not control the relay until the command “~AA1” is sent to clear the WDT timeout status.

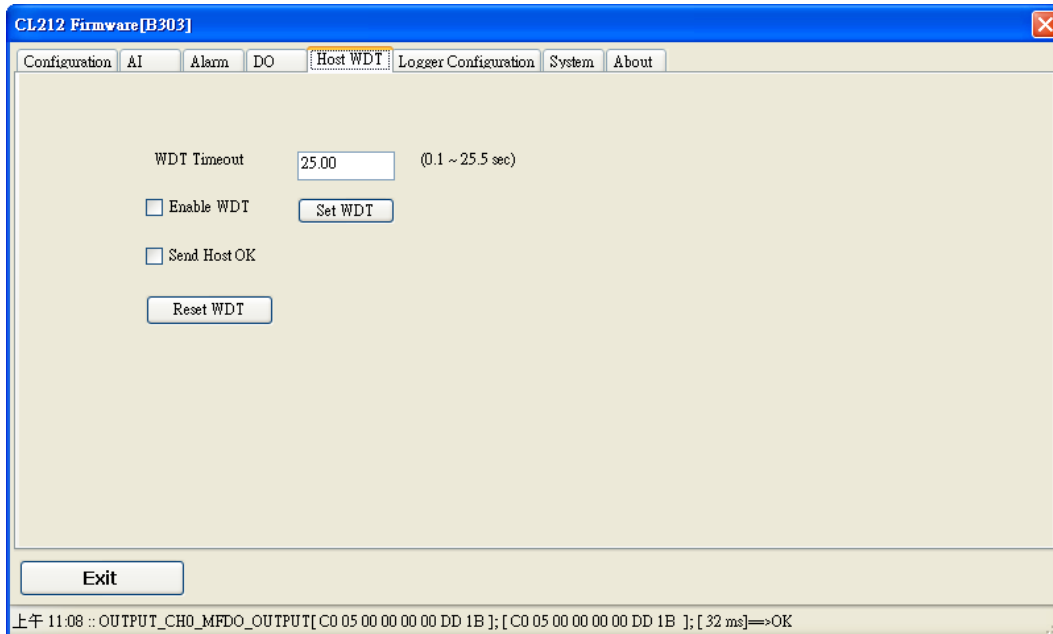

On this tab:

1. Set the time period for WDT timeout, check the checkbox next to Enable WDT and click the Set WDT button to enable the Host watchdog.
2. Check the checkbox next to Send Host OK to send the “~**” command.
3. Uncheck the checkbox next to Send Host OK to stop sending ~** command, the Host watchdog timeout will occur and relay will turn to Safe value.
4. Click the Reset WDT button to clear the Host watchdog timeout status.
5. Uncheck the checkbox next to Enable WDT and click the Set WDT button to disable the Host watchdog.

Note

The relay will not turn to Safe value when any one of the alarm for PM2.5/CO/CO₂ concentration, temperature, humidity and dew point is enabled. If any one alarm is enabled, the relay will be linked to the Alarm status. In case an Alarm occurs, the relay turns ON, it can be used to turn on the user's alarm light or beeping alarm or other device.

➤ Logger Configuration

Set the logger configuration on this TAB.

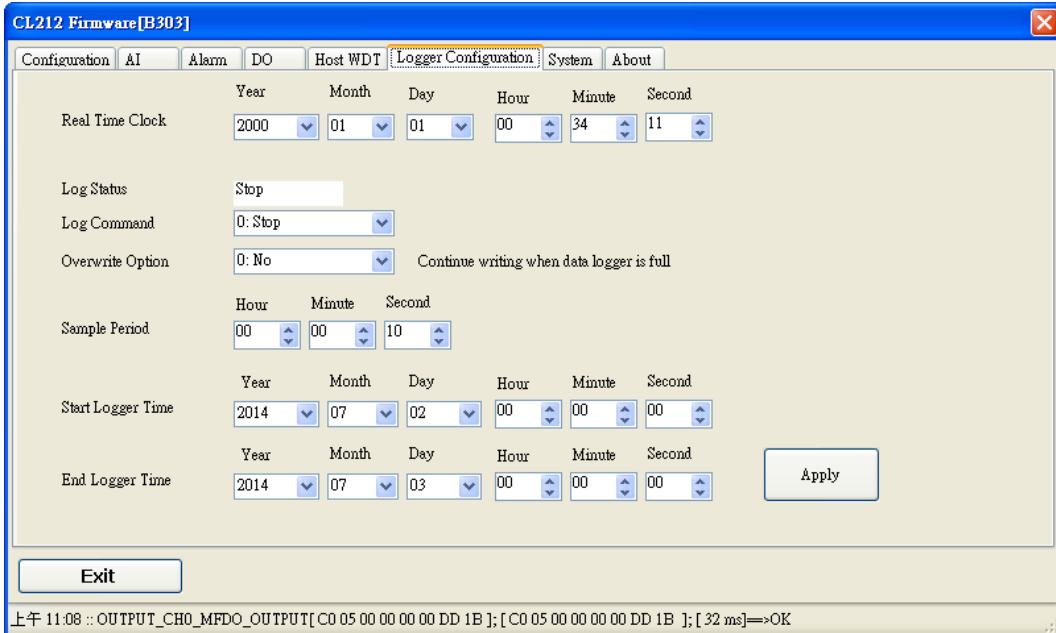

CL212 Firmware [B303]

Configuration | AI | Alarm | DO | Host WDT | **Logger Configuration** | System | About

Real Time Clock: Year: 2000, Month: 01, Day: 01, Hour: 00, Minute: 34, Second: 11

Log Status: Stop

Log Command: 0: Stop

Overwrite Option: 0: No (Continue writing when data logger is full)

Sample Period: Hour: 00, Minute: 00, Second: 10

Start Logger Time: Year: 2014, Month: 07, Day: 02, Hour: 00, Minute: 00, Second: 00

End Logger Time: Year: 2014, Month: 07, Day: 03, Hour: 00, Minute: 00, Second: 00

Buttons: Exit, Apply

Status Bar: 上午 11:08 :: OUTPUT_CH0_MFDO_OUTPUT[C0 05 00 00 00 00 DD 1B]; [C0 05 00 00 00 00 DD 1B]; [32 ms]==>OK

➤ **System Tab**

Click the Edit button to enable settings on this tab.

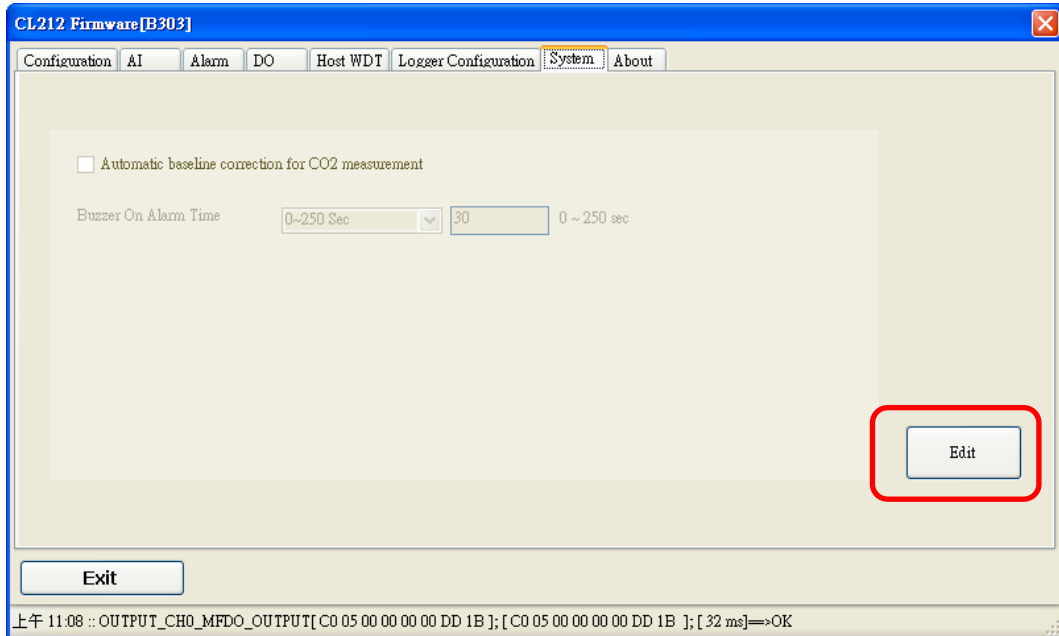

Check/Uncheck the item to Enable/Disable ABC function(For CL-202-E, CL-212-E, CL-203-E, CL-213-E only)

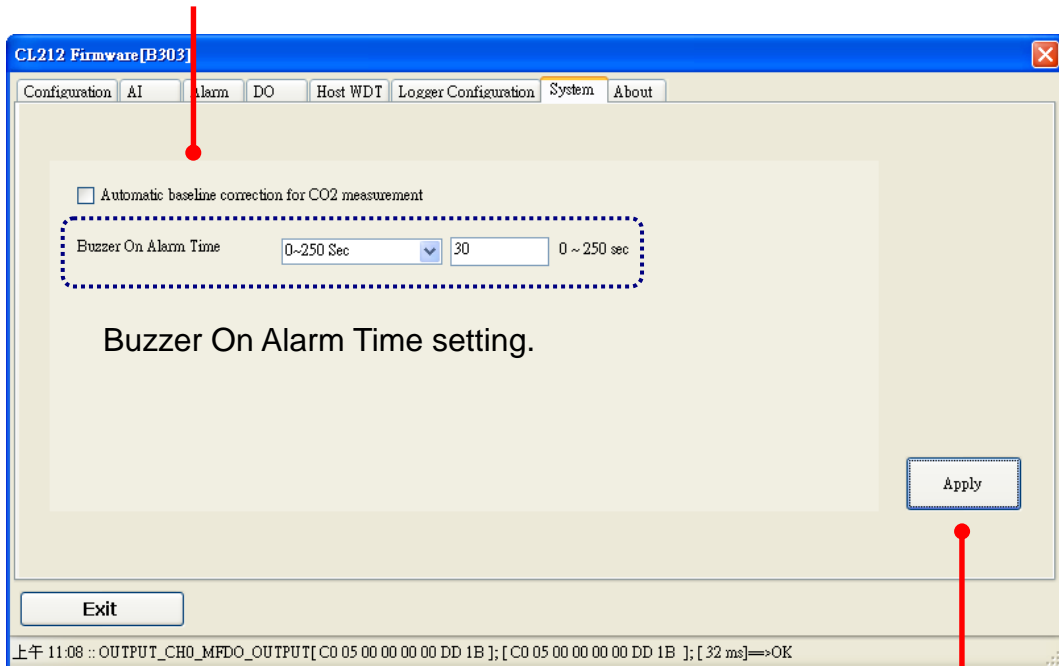

Buzzer On Alarm Time setting.

Click the Apply button to save settings.

➤ INIT

In case of the following situations, users have to set the pin 4.INIT on SW1 in the ON position and power-cycle the CL-200 module:

- Change protocol from PC
- Change DCON configuration such as baudrate, parity and checksum
- Communication failure with a CL-200 module.

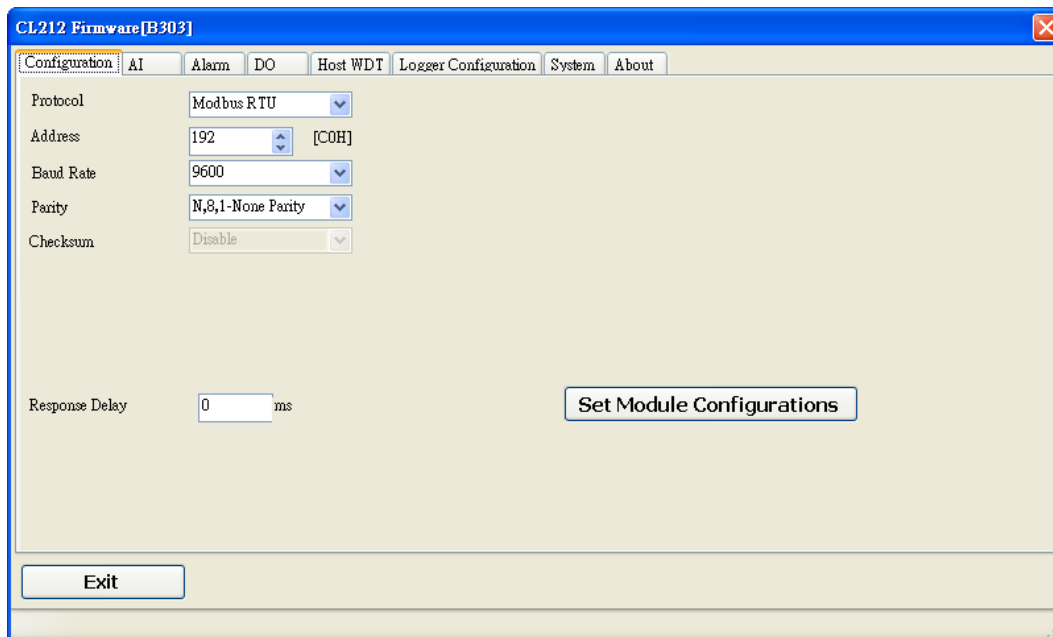

When a CL-200 module is powered-on with the pin 4.INIT in ON position, the protocol is DCON, address is 0, Baud Rate is 9600 bps, Parity is set to N/8/1 and Checksum is disabled.

After configuring the communication parameters, click the *Set Module Configurations* button, set the INIT to OFF position and power-cycle the CL-200 to take the settings effect.

Note

The INIT switch does not need to be set in the ON position when changing the address, baudrate and parity for ModbusRTU communication; users only have to power-cycle the module after complete configuration.

5. Configuration via Wi-Fi

- The factory default settings for Wi-Fi communication of the CL-200-WF are as follows.
 - Mode: AP
 - Wireless Security: WPA/WPA2, "00000000"
 - DHCP Server (AP Mode): DHCP Server on, start IP: 192.168.255.2
 - Wi-Fi Channel (AP Mode): 11
 - IP Address: 192.168.255.1
 - Gateway Address: 192.168.255.254
 - Subnet Mask: 255.255.0.0
 - SSID: CL-213-WF
 - Modbus TCP Port: 502

The Wi-Fi IIOT Utility is provided to configure and test the CL-200-WF module through the Wi-Fi interface.

- Install Wi-Fi IIOT Utility

The installation file location of the Wi-Fi IIOT Utility is at:
<http://ftp.icpdas.com/pub/cd/iiot/utility/>

- Search and Find the Module

Click on the search button to find the modules via the Wi-Fi interface.

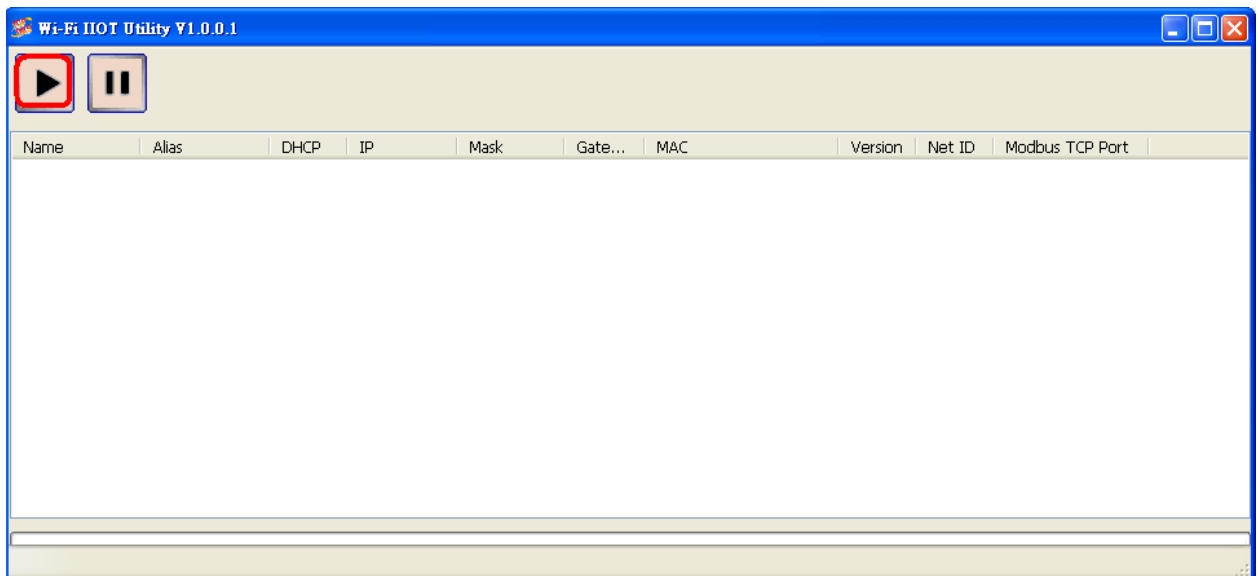

Select the Wi-Fi network interface and click on the OK button.

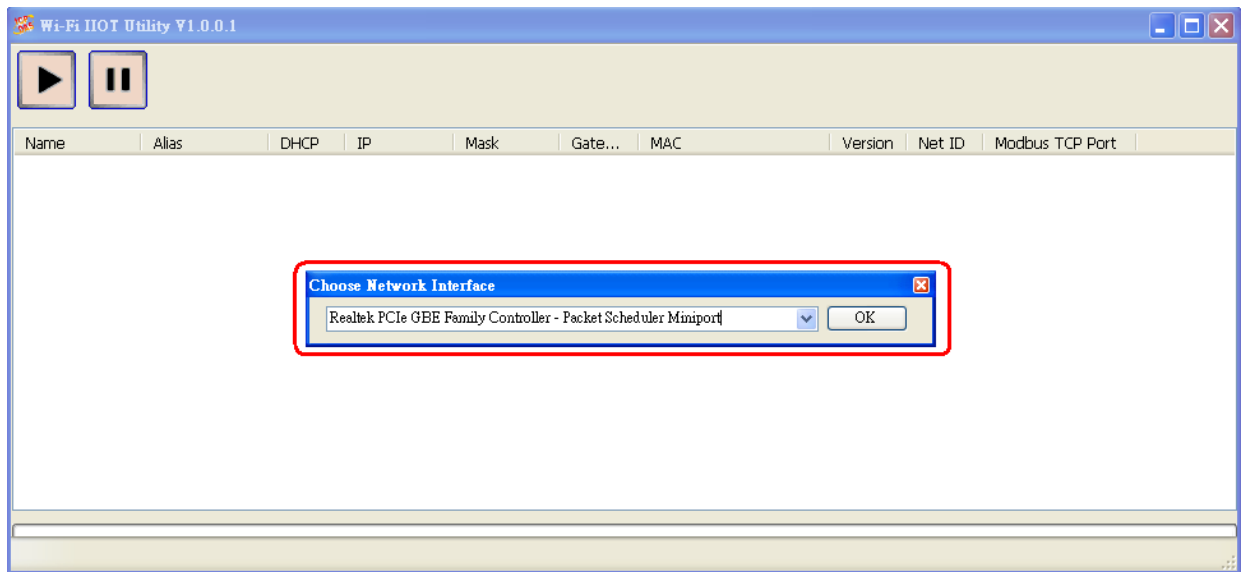

➤ **Configure and Test the Module**

When the module is found, click on the module name to enter the configuration form.

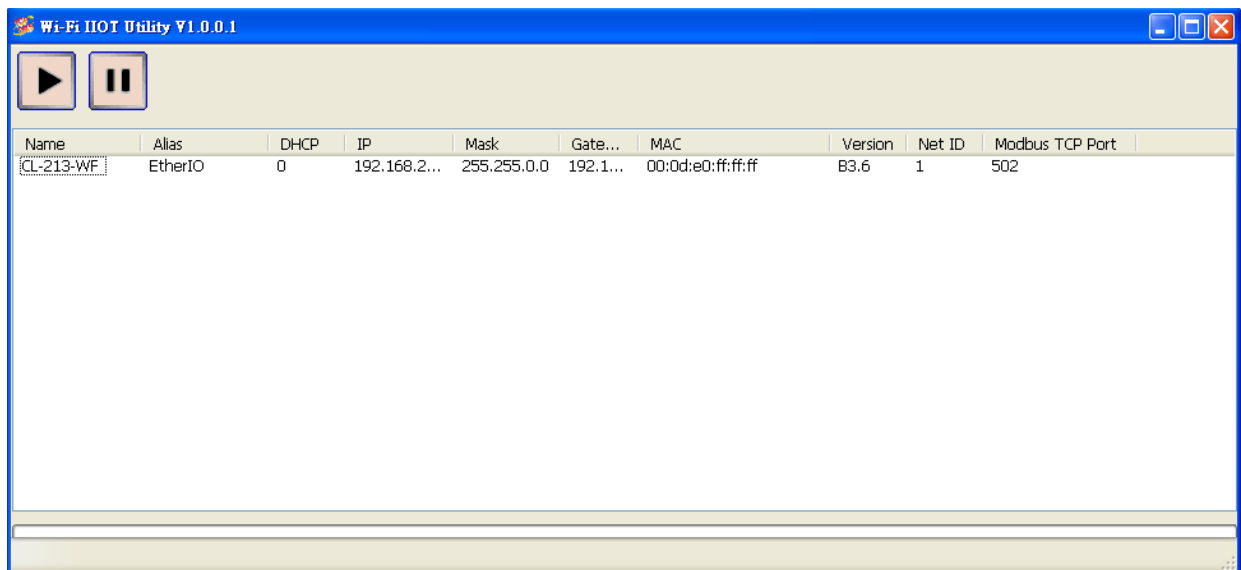

In the Configuration form, you can change the Wi-Fi related settings. Click on the Set Module Configurations button to save the changes to the module.

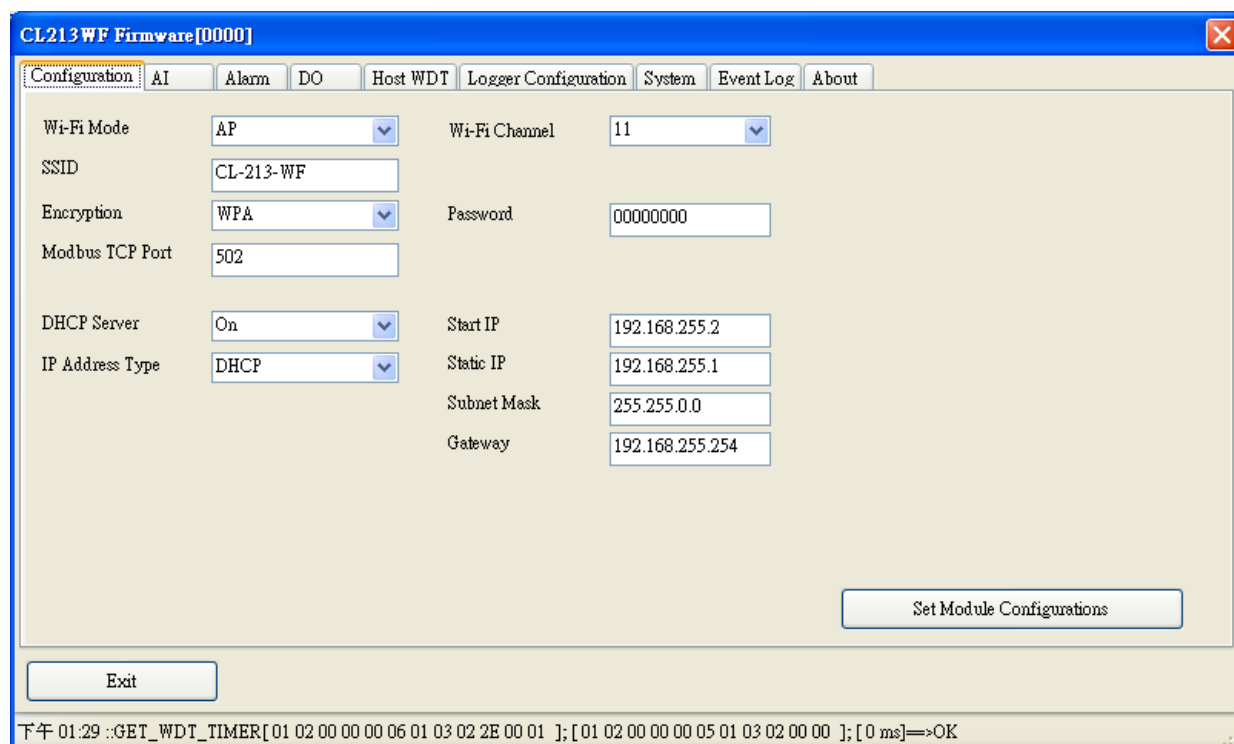

The followings show the detailed description of each setting.

Item	Description
WiFi Mode	This parameter is used to specify the Wi-Fi mode of the SL device. It can be Station or AP. For AP mode, only one device can be connected.
SSID	This parameter is used to specify the Service Set Identifier. For station mode, specify the SSID of the AP you would like to connect. For AP mode, the SSID will be used by the device to be connected.
Encryption	This parameter is used to specify which security protocol is used to secure wireless computer network. It can be open, WEP, or WPA. It is recommended to use WPA if possible.
Modbus TCP Port	This parameter is used to set the local port of the Wi-Fi interface to be used by the Modbus slave device. The default value is 502.
DHCP Server	This parameter is used to specify whether to turn on the DHCP server function. It is only available to the AP mode.
IP Address Type	This parameter is only available to the station mode and it can be Static or DHCP. If DHCP is supported by the AP you would like to connect, then DHCP should be selected. Otherwise, select Static and the following three parameters Static IP, Subnet Mask and Gateway should be set, too.

WiFi Channel	This parameter is used to specify which channel is used for Wi-Fi transmission. It can be 1 to 11. It is only available to the AP mode.
Static IP	Each SL device connected to the Wi-Fi network must have its own unique IP address. This parameter is used to assign a specific IP address.
Subnet Mask	This parameter is used to assign the subnet mask for the SL device. The subnet mask indicates which portion of the IP address is used to identify the local network or subnet.
Gateway	This parameter is used to assign the IP address of the gateway to be used by the SL device. A gateway (or router) is a device that is used to connect an individual network to one or more additional networks.

In the AI form, you can read the sensor readings such as PM2.5, CO, CO₂, humidity, temperature and dew point temperature.

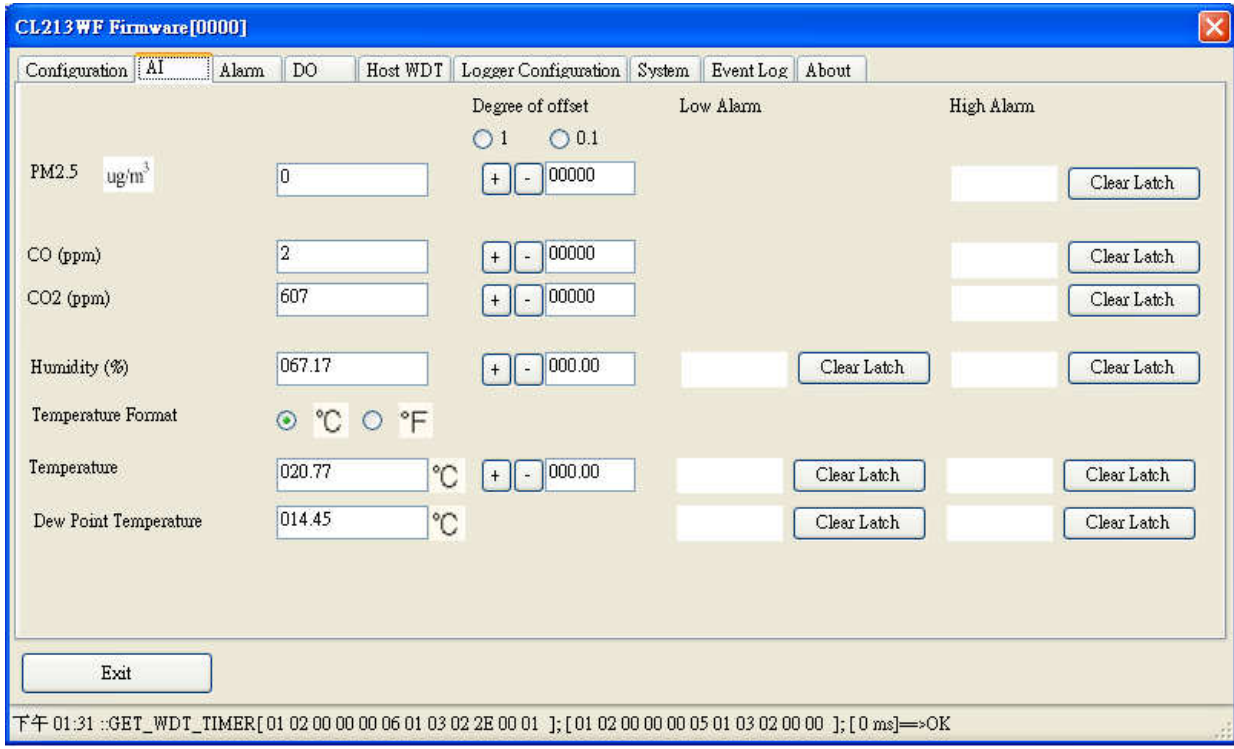

In the Alarm form, you can change the alarm related settings. Click on the Set Alarm Configurations button to save the changes to the module.

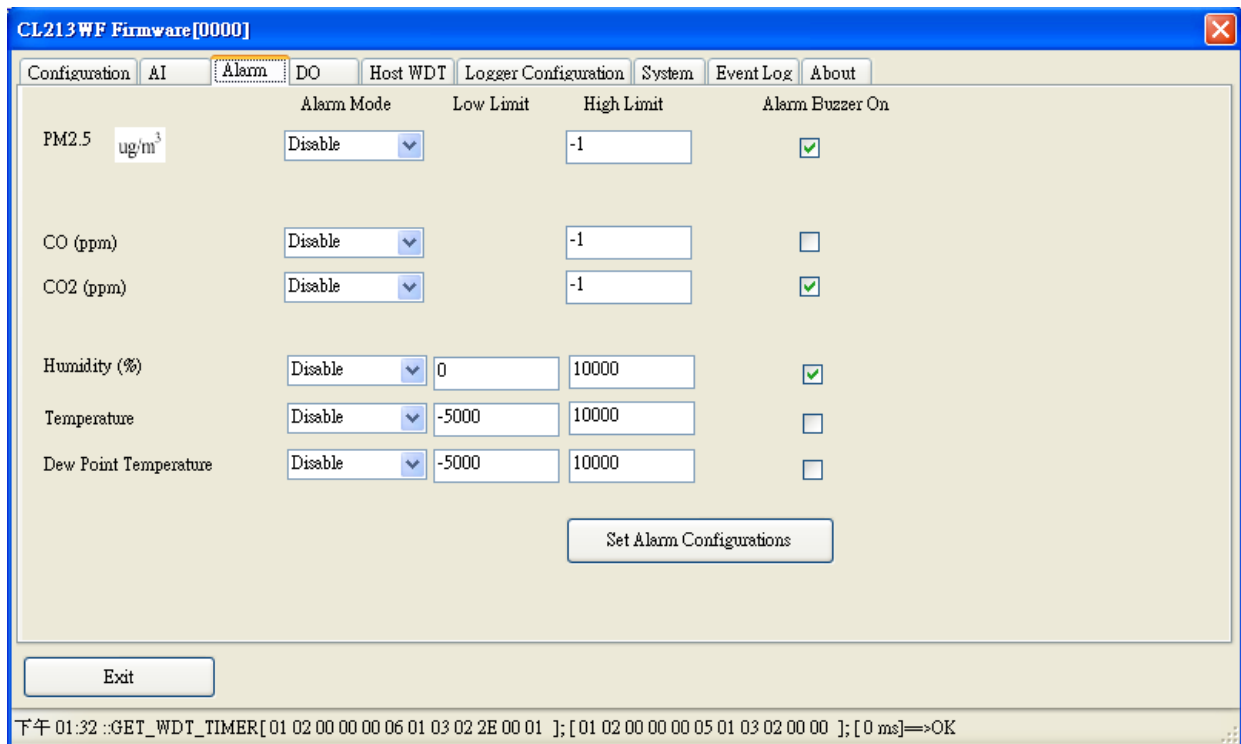

In the DO form, you can change the digital output status and the power on and safe digital output settings.

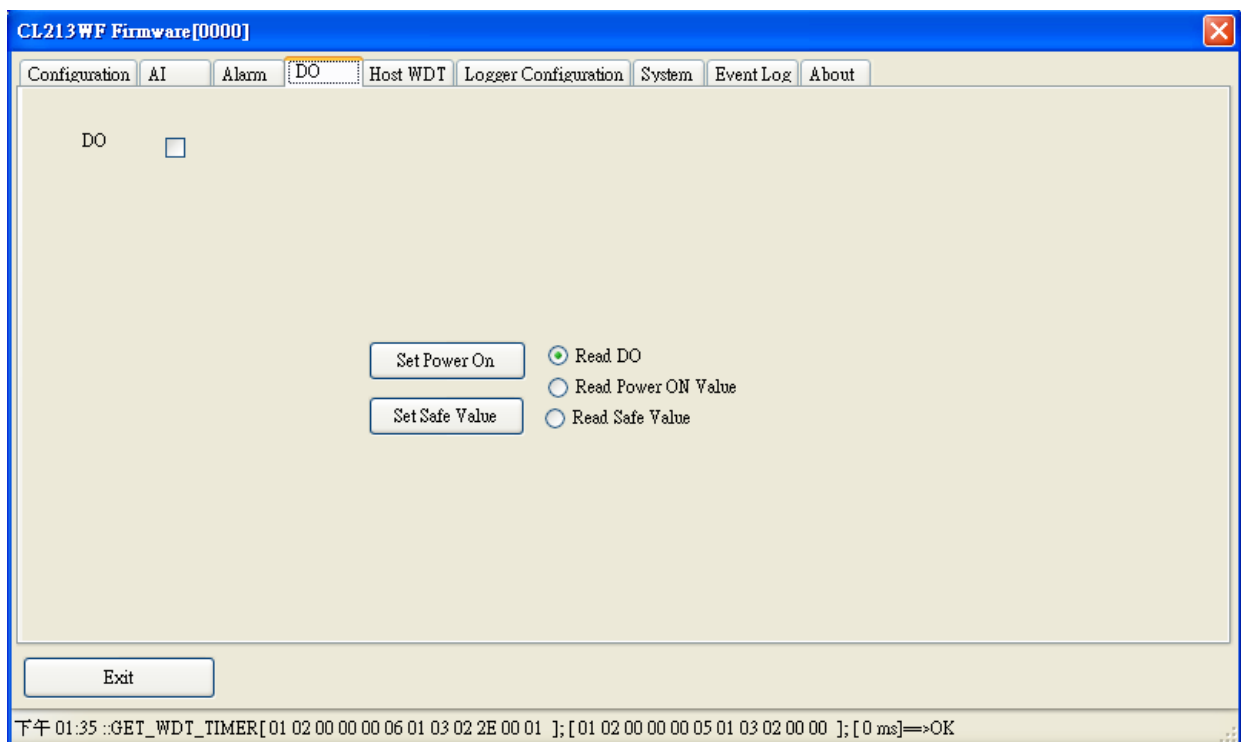

In the Data Logger form, you can change the data logger related settings. Click on the Apply button to save the changes to the module.

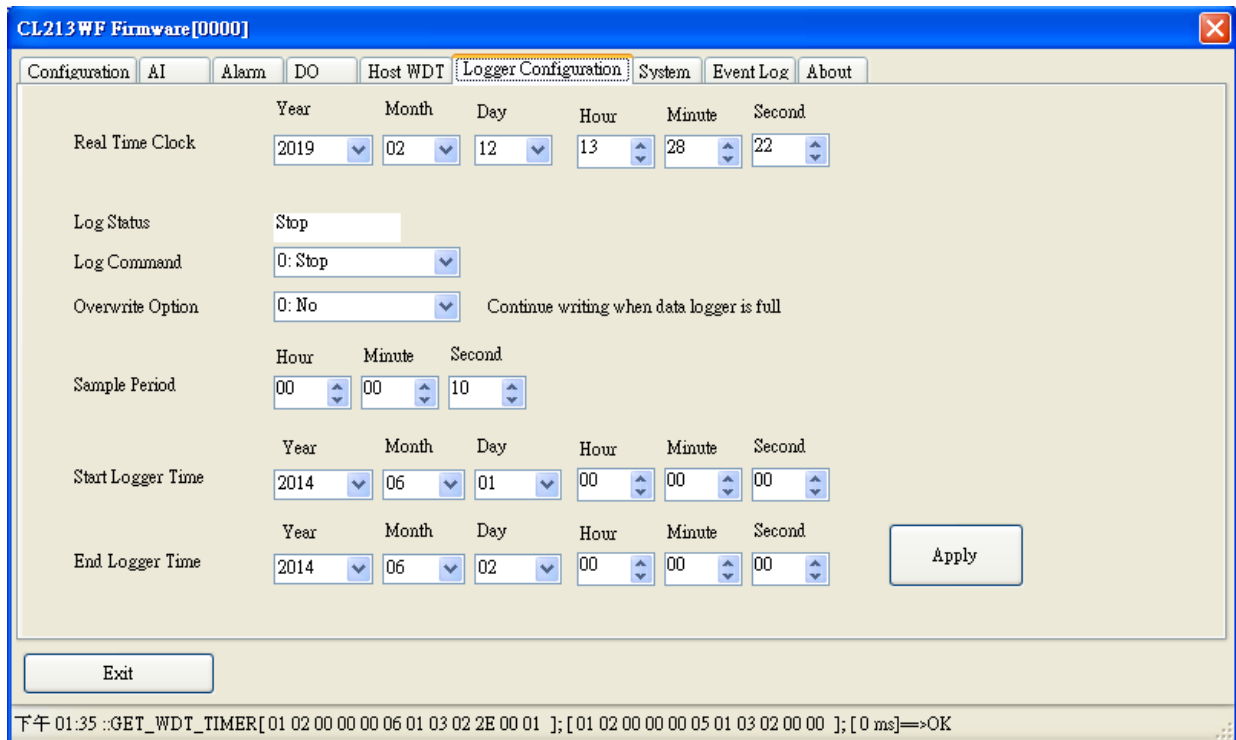

6. Monitoring via Mobile Devices

The iAir App can be used to monitor real-time data of PM2.5, CO/CO₂ level, NH₃, H₂S, HCHO, TVOC, temperature and humidity anywhere and anytime without any complicated configuration. The CL-200 modules and your mobile devices such as smart phones or tablets need be addressed on the same network, and then you can get the real-time data from CL-200 loggers by entering a specific IP address, or by performing an automatic search for available devices.

If a CL-200 can't be searched in the iAir App, please contact with the network administrator to make sure the module and your mobile devices are addressed on the same sub-network. It means that they have the same broadcast address.



The iAir app is available to free download in Google Play and App Store. Search “iAir” in or search “iAir”, “ICPDAS” in App Store and tap on install.

The iAir user manual can be obtained from
<http://ftp.icpdas.com/pub/cd/iiot/cl-200/document/>

7. Utility to Get/Manage Data Log

DL-300 Utility is a convenient, easy-to-use management utility running on Windows platform that allows users to monitor the real-time data and trend chart from CL-200 modules on the Ethernet, it can group the CL-200 modules for group view management, log alarm events with timestamp, download the logged data from a CL-200 logger and export the data to *.csv files for performing statistical analysis in Excel.

The DL-300 Utility can be obtained from:

<http://ftp.icpdas.com/pub/cd/iiot/utility/>

1. Run the DL-300_utility_setup_yyyymmdd.exe, the default install location is C:\ICPDAS\DL300_Utility\DL-300 Utility

2. Open the DL-300 Utility by double clicking on the DL-300 Utility shortcut on desktop.



3. Search out a CL-200 module on the Ethernet and set the configuration.

3-1. Select the **Device Settings** on the **Settings** menu.

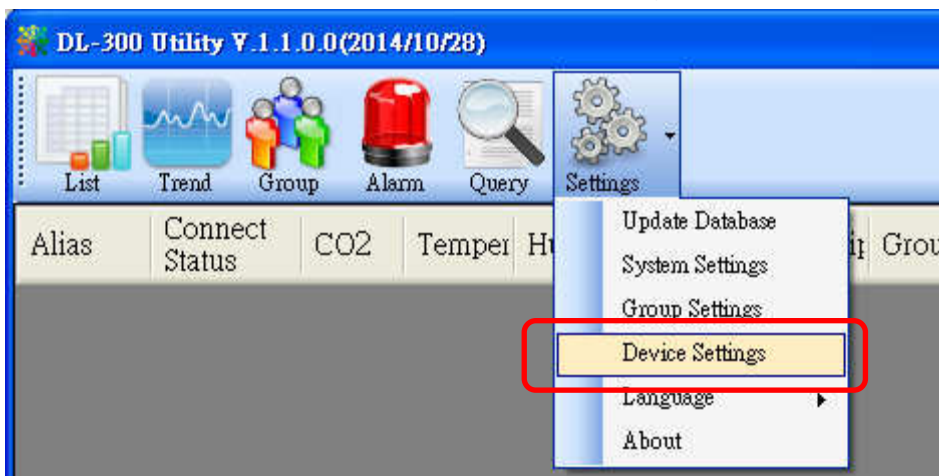

3-2. Click the **Search New Device** button to search the CL-200 modules connected on the same Ethernet network.

3-3. Check the checkbox next to a module and click the **Add** button to add the module in the utility.

3-4. Highlight a module and click the **Edit Device** button to configure the module.

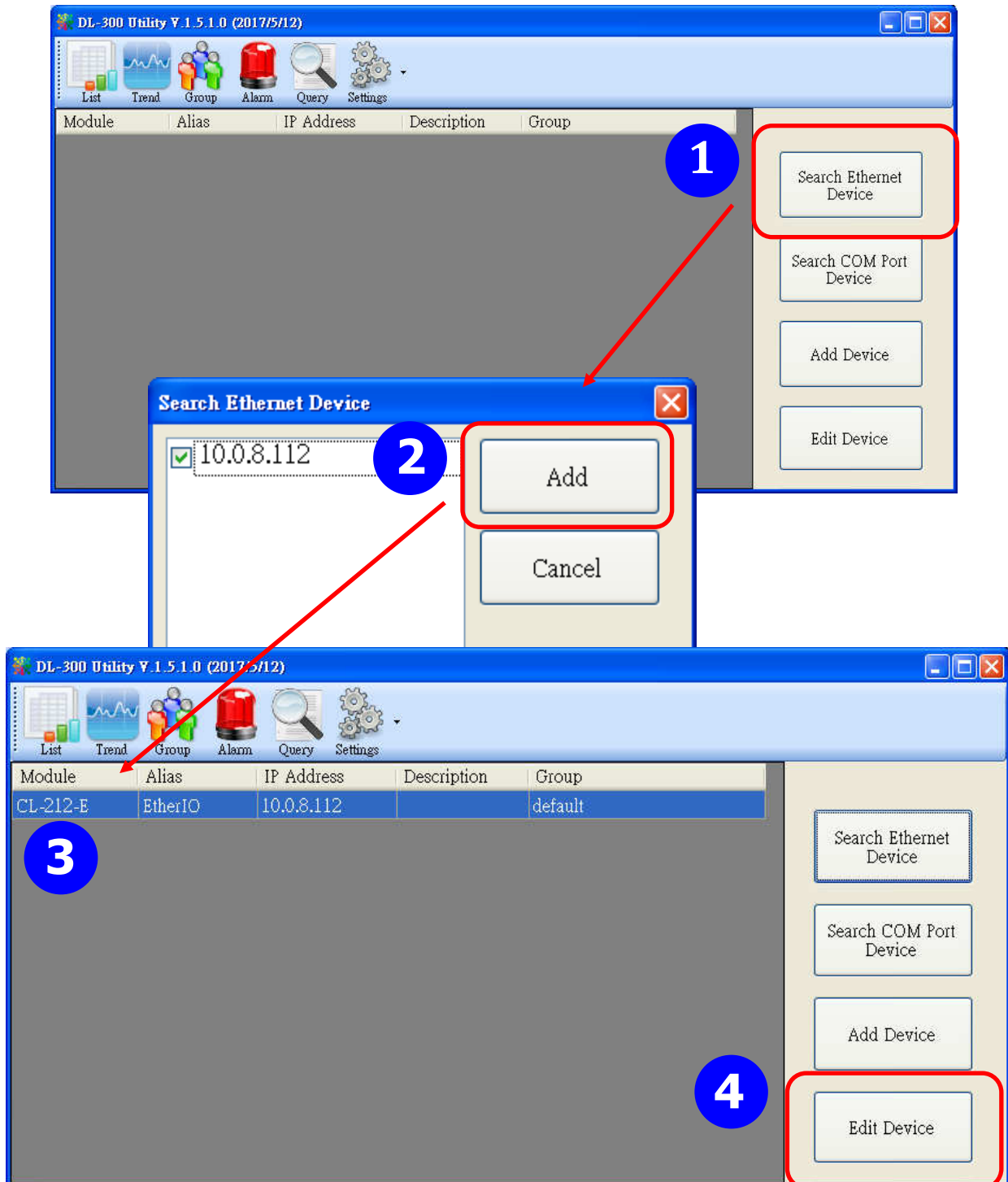

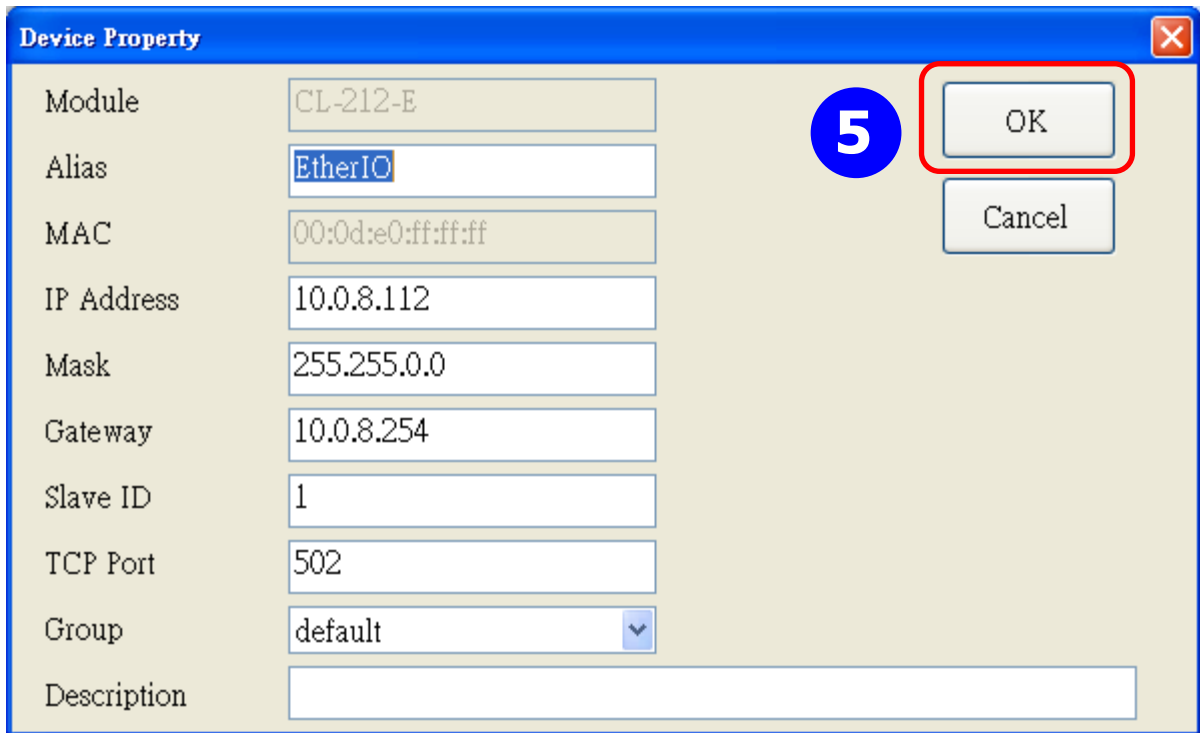

4. Get real-time data, trend chart and alarm event.

4-1. Click the **List** icon to obtain the real-time data. It also lists the connect status, group information and IP address for every CL-200 logger.

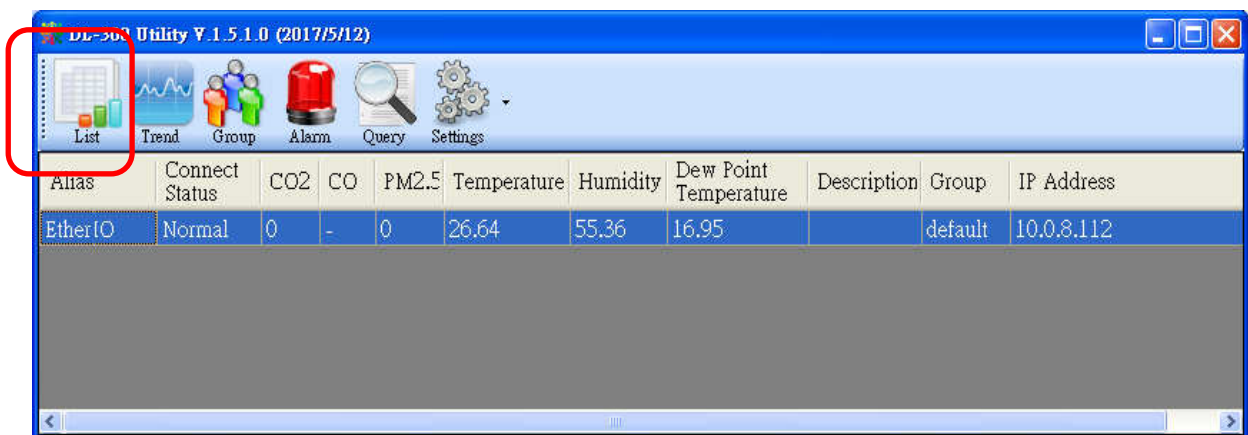

4-2. Click the **Trend** icon to display the trend chart. Users can select the radio button for CO/CO₂ level, Temperature or Humidity to access the trend chart for those real-time data, check the checkbox next to each CL-200 logger to display its trend chart or uncheck it to cancel display. Drag and drop the trend chart can move it to see the data not be displayed in the chart.

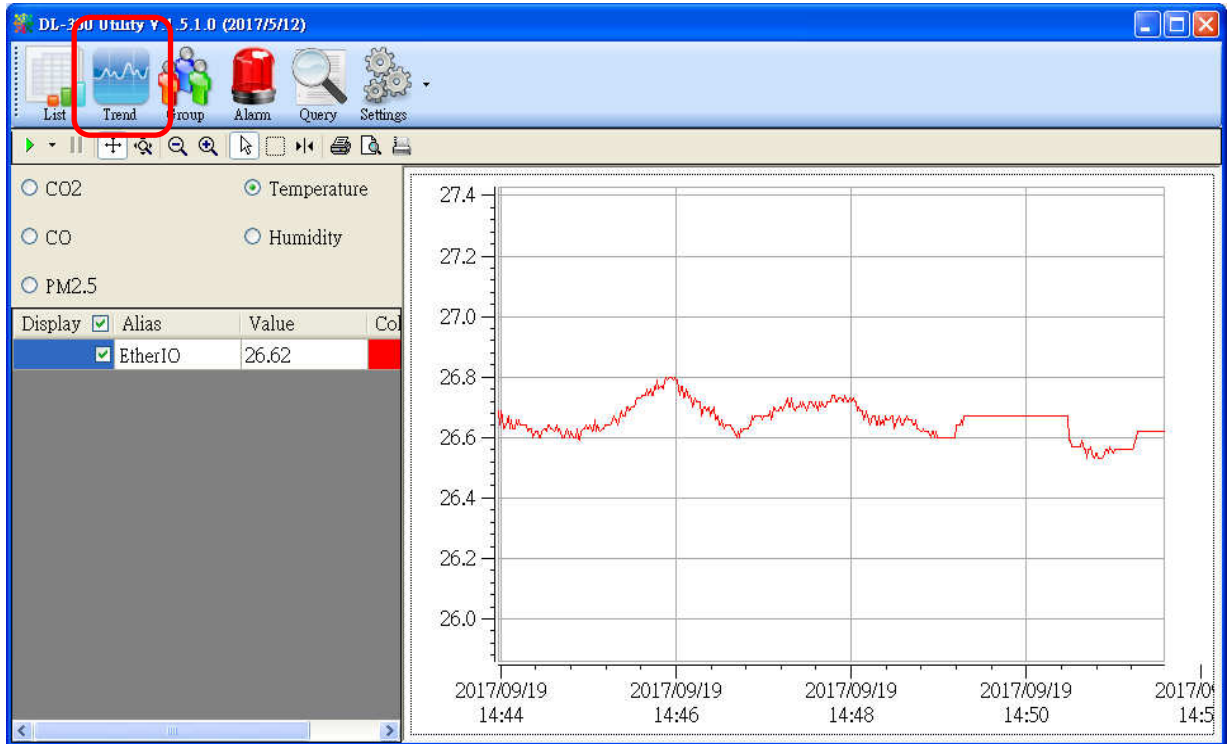

4-3. Click the **Alarm** icon to review the alarm events.

The screenshot shows the 'DL-300 Utility' software interface. The 'Alarm' icon in the top toolbar is circled in red. Below the toolbar is a table with the following columns: Alias, CO2, Temperature, Humidity, Dew Point, Description, Group, IP Address, and Alarm. The table contains 10 rows of data, all with yellow background highlighting in the 'Alarm' column.

Alias	CO2	Temperature	Humidity	Dew Point	Description	Group	IP Address	Alarm
Room8A	901	25.4	62.86	17.8		1F	10.1.0.120	CO2 is over Alert Value at time:2014/11/21
Room8A	904	25.42	62.89	17.83		1F	10.1.0.120	CO2 is over Alert Value at time:2014/11/21
Room8A	899	25.33	62.86	17.74		1F	10.1.0.120	CO2 is over Alert Value at time:2014/11/21
Room8A	898	25.34	62.83	17.74		1F	10.1.0.120	CO2 is over Alert Value at time:2014/11/21
Room1A	796	27.4	56.97	18.11		1F	10.1.0.86	CO2 is over Alert Value at time:2014/11/21
Room1A	795	27.46	56.98	18.17		1F	10.1.0.86	CO2 is over Alert Value at time:2014/11/21
Room1A	792	27.44	56.98	18.15		1F	10.1.0.86	CO2 is over Alert Value at time:2014/11/21
Room1A	794	27.42	56.99	18.14		1F	10.1.0.86	CO2 is over Alert Value at time:2014/11/21
Room1A	791	27.45	56.95	18.15		1F	10.1.0.86	CO2 is over Alert Value at time:2014/11/21
Room1A	793	27.45	56.98	18.16		1F	10.1.0.86	CO2 is over Alert Value at time:2014/11/21

4-4. Modify the event condition.

Select the **System Settings** on the **Settings** menu.

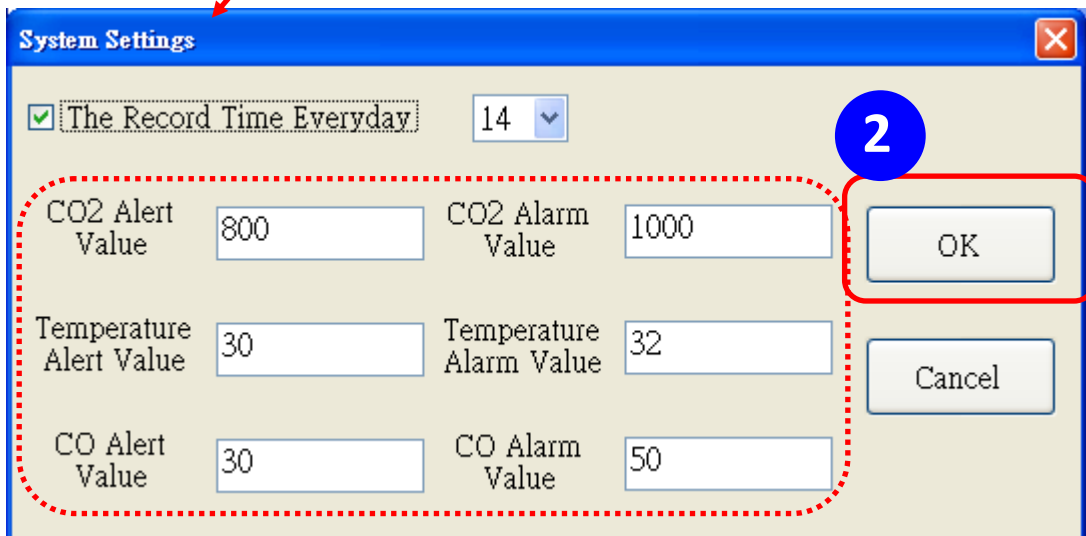
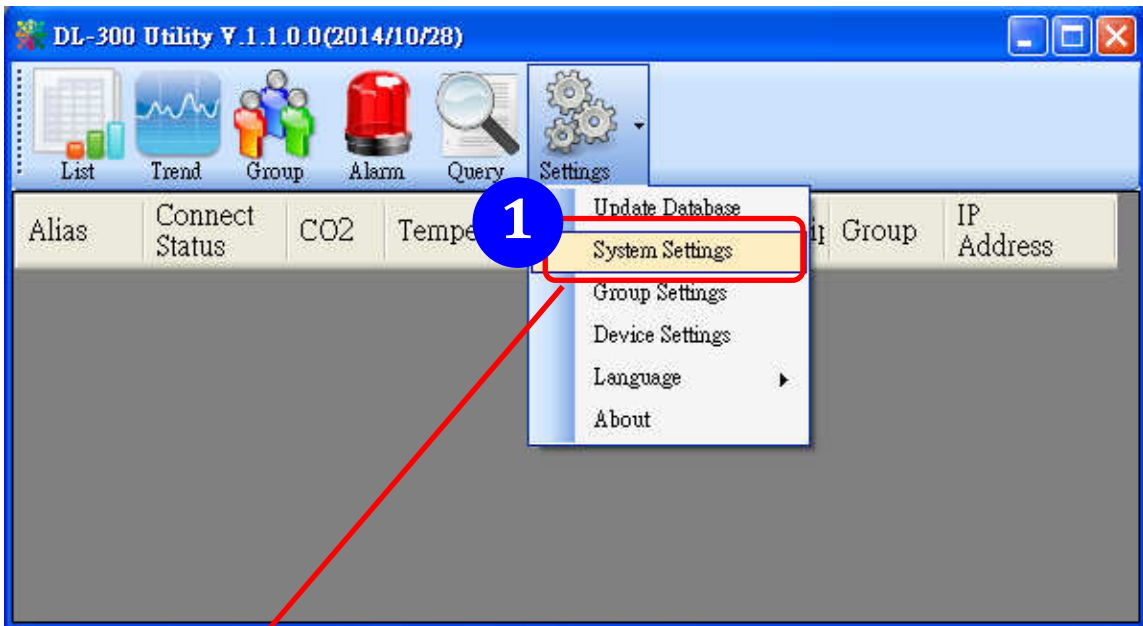

Set the *CO/CO₂ Alert Value*, *CO/CO₂ Alarm Value* (If it is supported in the logger), *Temperature Alert Value* and *Temperature Alarm Value* for trigger events. Check the checkbox next to *The Record Time Everyday* can schedule auto generate report everyday at the time set in the dropdown menu. Click on the **OK** button to complete the settings.

5. Download data in a CL-200 logger and export the data
 - 5.1. Select **Update Database** on the Settings menu
 - 5.2. Click the **Start** button to download the data in CL-200 modules.
 - 5.3. Click the close icon to exit the download procedure when all data are downloaded.

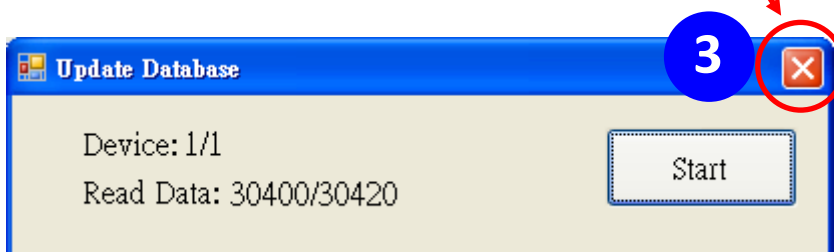
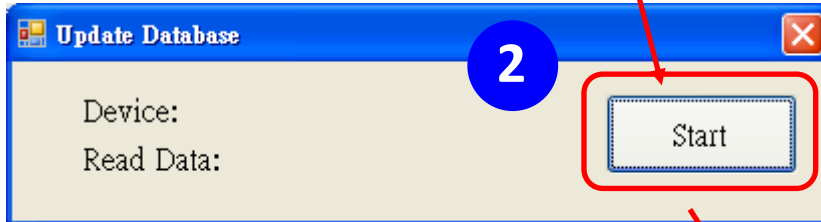
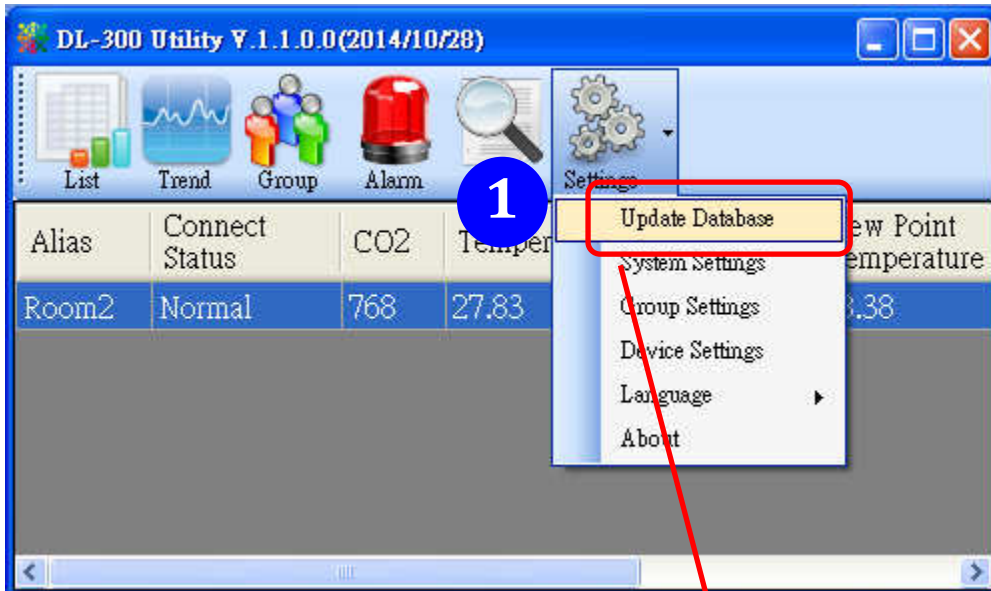

5.4. Click the **Query** icon.

5.5. Highlight the desired module, set the *Start Time* and *End Time*, and then click the **Search** button. The data in the time period will be listed as below.

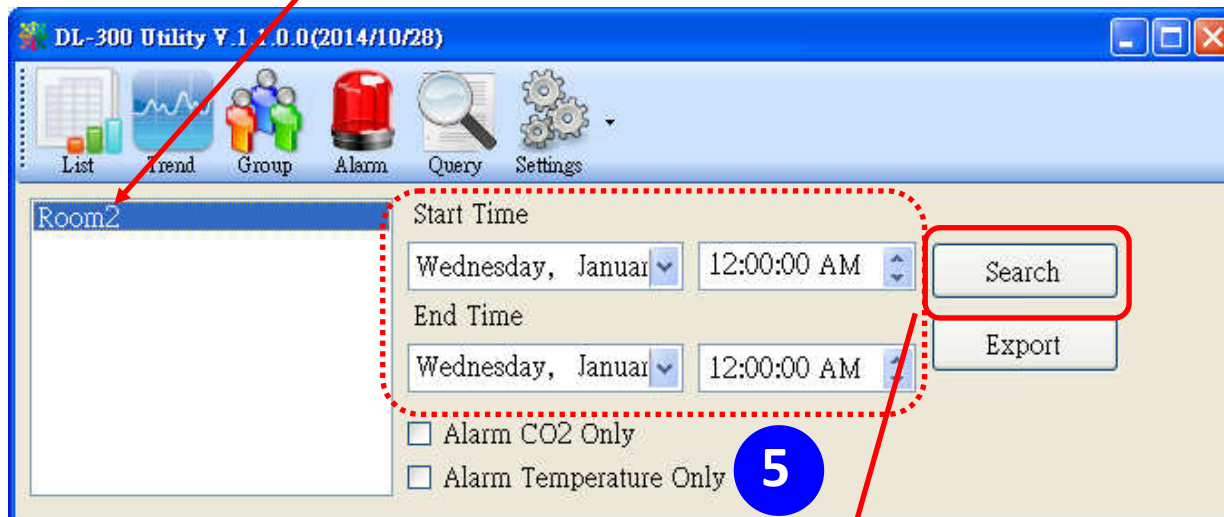
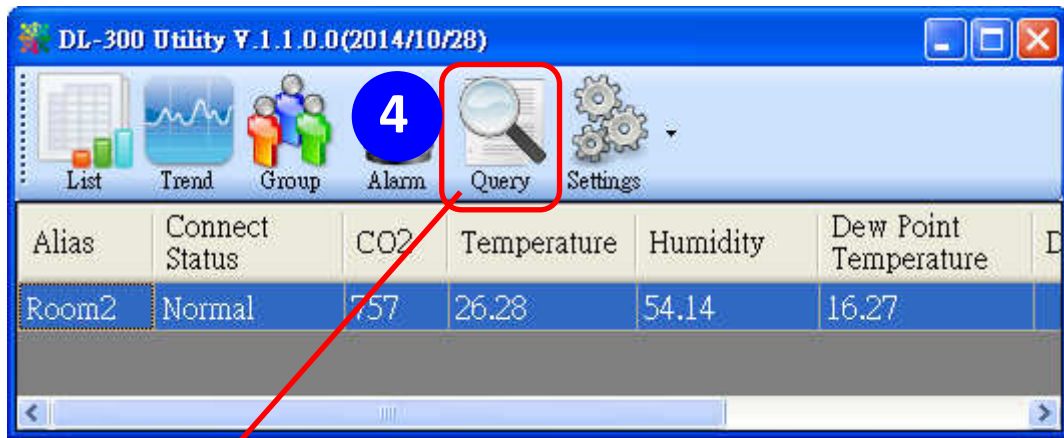

Time	CO2	Humidity	Temperature	Dew Point
2014/11/25 ...	0	67.85	23.19	16.76
2014/11/25 ...	853	66.72	23.42	16.76
2014/11/25 ...	1187	67.29	23.7	17.16
2014/11/25 ...	864	65.07	23.92	16.93
2014/11/25 ...	923	64.83	24.13	17.1
2014/11/25 ...	852	64.34	24.32	17.19
2014/11/25 ...	818	63.25	24.52	17.17
2014/11/25 ...	796	62.58	24.68	17.2

5.6. Click the **Export** button to export the searched data in *.csv files for performing statistical analysis in Excel.

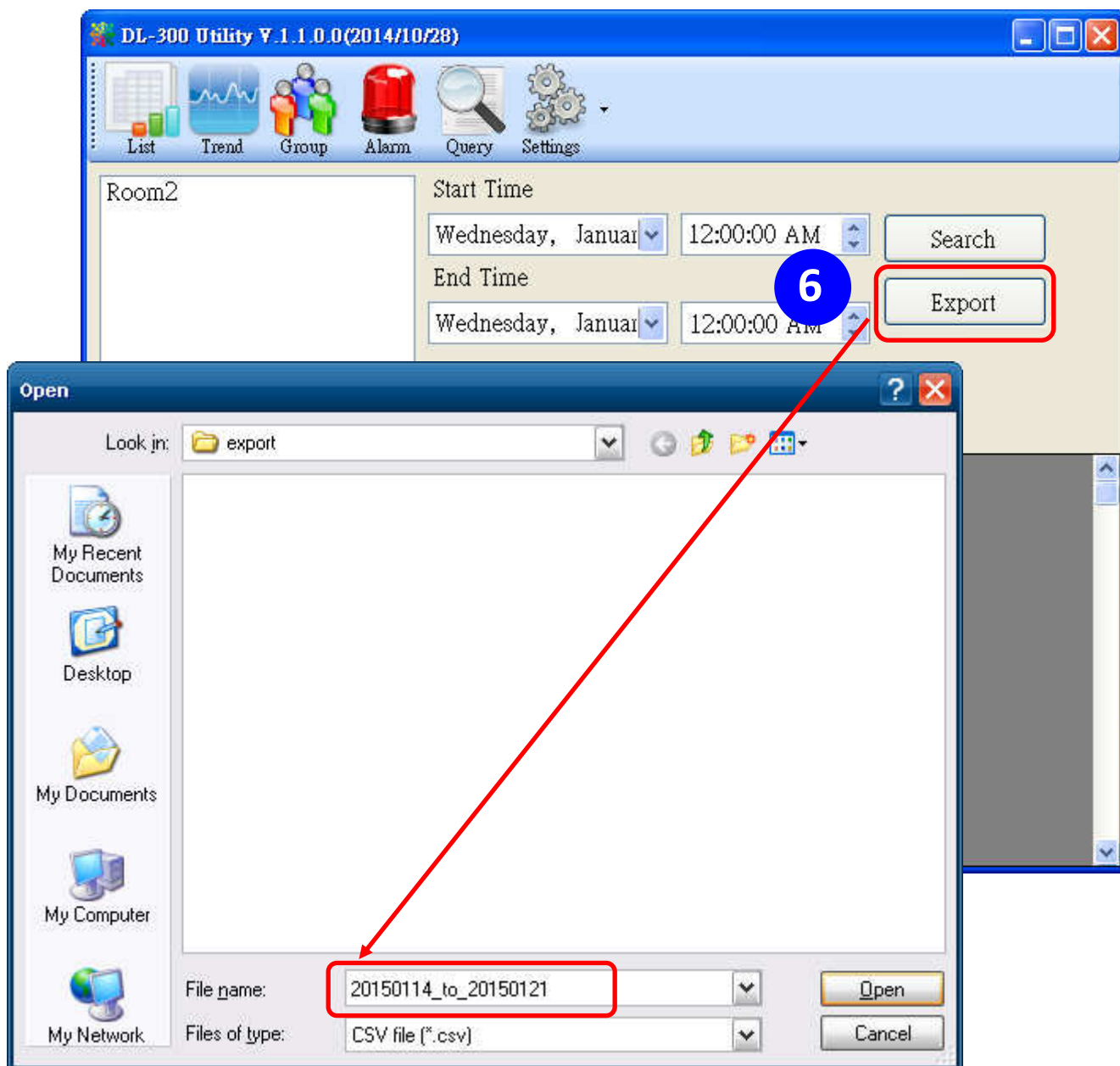

- 6. Group the devices by location or users
 - 6.1. Select **Group Settings** on the Settings menu.

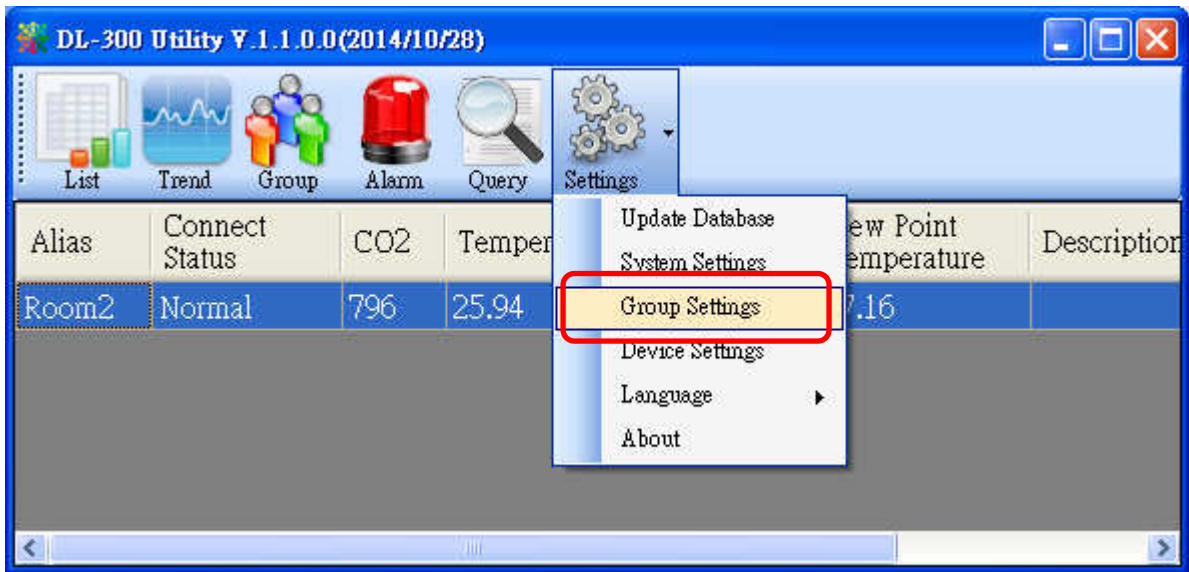

- 6.2 Click the **New** button, enter the group name and click the **OK** button in the pop-up box, and then click the **OK** button in the Group Settings box.

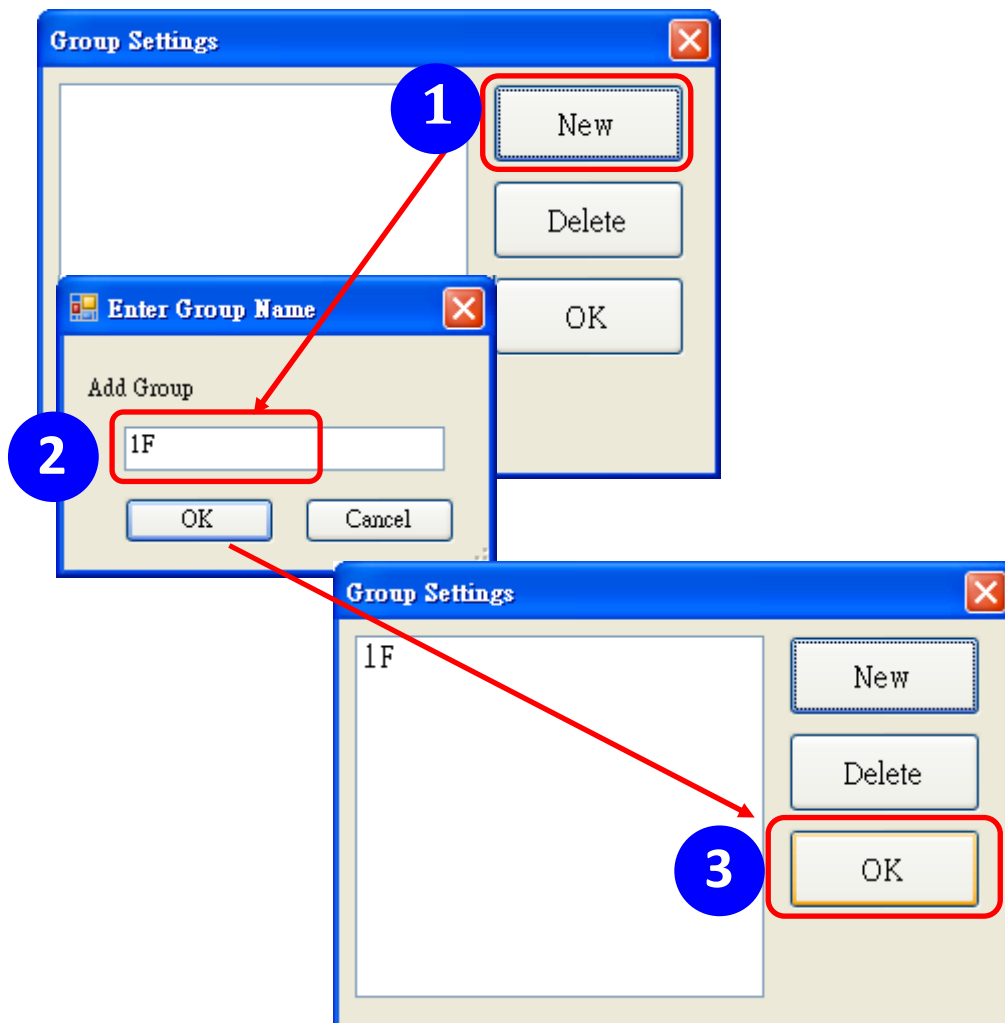

6-3. Select **Device Settings** on the **Settings** menu; highlight the desired device and click the **Edit Device** button, select the group name for the module and click the **OK** button in the pop-up **Device Property** box to complete the setting.

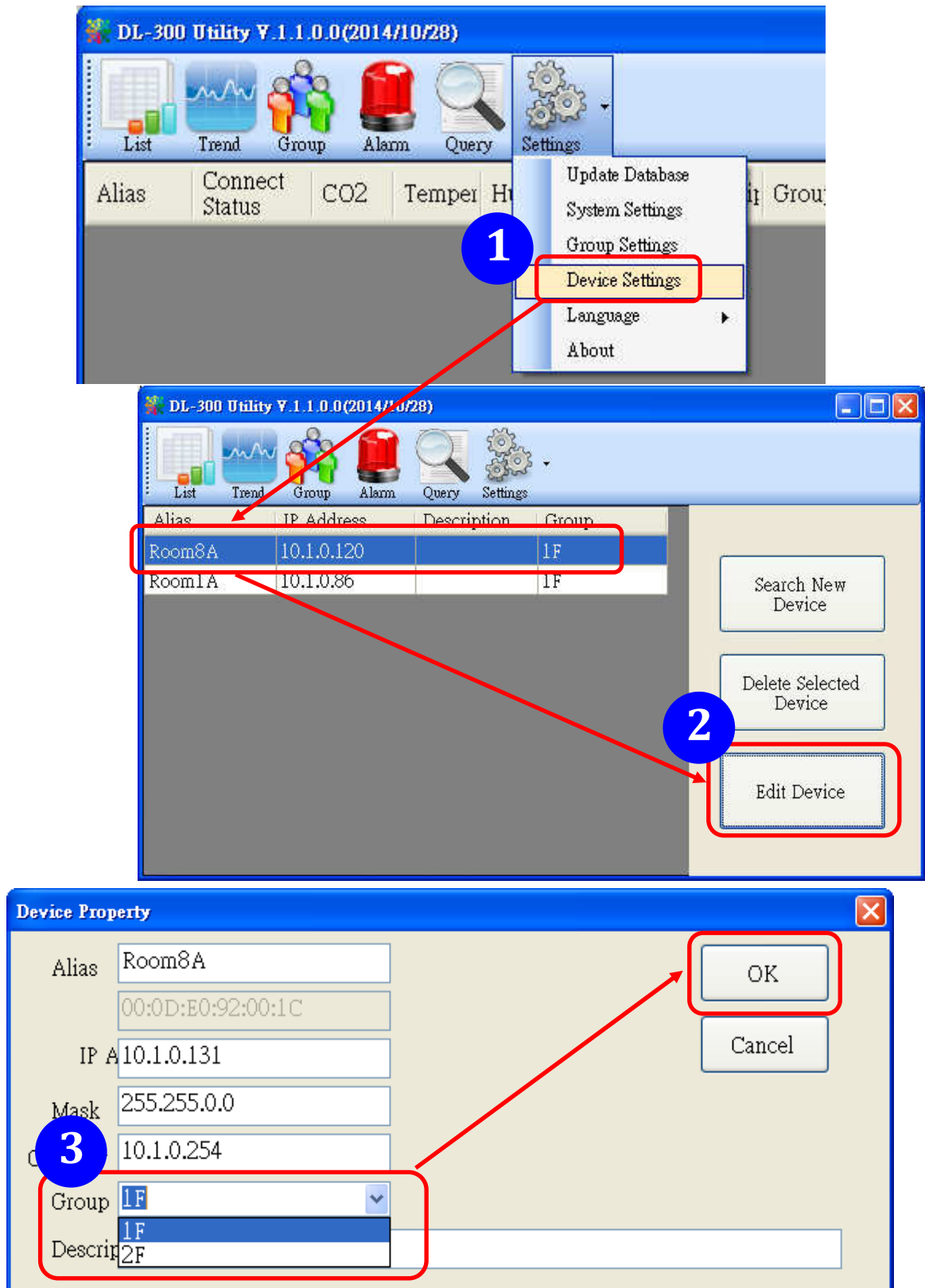

6-4. Monitor the group data by clicking the **Group** icon and then highlighting the group name.

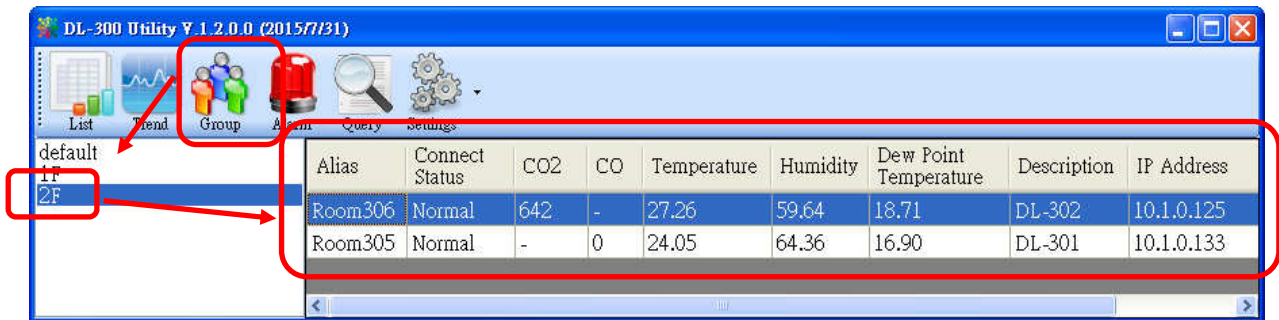

8. FAQ

Q1: What is ABC (Automatic Baseline Correction)?

A1: ABC stands for the Automatic Baseline Correction which is used to adjust a shifted baseline to the carbon dioxide level in fresh air. In case of normal indoor application, the carbon dioxide level drops to nearly outside air where there are no human, green plants or anything to elevate the carbon dioxide levels on weekday evenings or weekends, the ABC algorithm constantly keeps track of the lowest reading and slowly corrects it as the expected value in fresh air typically around 400 ppm.

Q2: Why I need to enable the ABC?

A2: When the CO₂ concentration detected in a period time of unoccupied space is greater than the base value of 400ppm, enable the ABC function to adjust the baseline. Be careful that the ABC will not work if a space is constantly occupied such as a hospital, 24-hr factory, 24-hr store, green house or other applications where CO₂ levels may be elevated at all times.

Q3: Does the CL-202/CL-212/CL-203/CL-213 enable the ABC as the factory default setting?

A3: No, the ABC is default disabled in a CL-202/CL-212/CL-203/CL-213 logger to prevent the baseline from being adjusted to an incorrect value in case of using in a constantly occupied space.

Q4: What to do when the ABC is no work?

A4: When the ABC is no work regarding baseline correction, the CL-202/CL-212/CL-203/CL-213 needs be returned to ICP DAS.

Q5: How to set the Accessible IP?

A5: Enter the IP address for your logger in the address bar of a web browser and go to the Accessible IP Settings page, select the radio button next to Add _____.____.____.____ To The List and key in the IP for a device which is allowed to access the CL-200, and then click the submit button.

Check the checkbox next to the Save to Flash before clicking the submit button to save the IP setting and use after repowering. Once any of those in the list is set, only the device for which the IP address is saved in the list can assess the CL-200.

Accessible IP List	IP Address
IP1	0.0.0.0
IP2	0.0.0.0
IP3	0.0.0.0
IP4	0.0.0.0
IP5	0.0.0.0

Add [] . [] . [] . [] To The List
 Delete IP# []
 Delete ALL
 Save to Flash

Copyright © 2014 ICP DAS Co., Ltd. All rights reserved.
10.1.0.31/filter.html

Q6: How to delete the Accessible IP settings?

A6: Enter the IP address for your logger in the address bar of a web browser and go to the Accessible IP Settings page, select the radio button next to Delete IP# to delete a IP by the IP number or select the radio button next tot Delete All and then click the submit button.

Check the checkbox next to the Save to Flash before clicking the submit button to save the IP setting and use after repowering.

Accessible IP List	IP Address
IP1	0.0.0.0
IP2	0.0.0.0
IP3	0.0.0.0
IP4	0.0.0.0
IP5	0.0.0.0

Add [] . [] . [] . [] To The List
 Delete IP# []
 Delete ALL
 Save to Flash

Copyright © 2014 ICP DAS Co., Ltd. All rights reserved.
10.1.0.31/filter.html

Q7: How to clear the data logged in a CL-200 module?

A7: Enter the IP address for the module in the address bar of a web browser and go to the I/O Settings page, click the Reset Data Logger button at the bottom of the page.



Appendix A: DCON Command Sets

A-1. CL-201-E DCON Command Sets

Command	Description
\$AAF	read firmware version
\$AAI	read INIT status response: !AA0 -> INIT short to GND !AA1 -> else
\$AAM	read module name
\$AAP	Read Modbus RTU/DCON protocol response: !AA0 -> DCON !AA1 -> Modbus RTU
\$AAPN	Set Modbus RTU/DCON protocol N-> 0: DCON, 1: Modbus RTU
\$AA2	read configuration
\$AA5	read reset status !AA1 first after power on, !AA0 others
#AA	Read All Analog Inputs response > (CO in 1 ppm) (relative humidity in 0.01%)(temperature in 0.01°C)(temperature in 0.01°F) (dew point temperature in 0.01°C)(dew point temperature in 0.01°F)
#AAN	Read Channel Analog Input N = 0 for CO in 1 ppm, 1 for relative humidity in 0.01%, 2 for temperature in 0.01°C, 3 for temperature in 0.01°F, 4 for dew point temperature in 0.01°C, 5 for dew point temperature in 0.01°F
%AANNTTCCFF	set configuration, NN: new address, TT = 00, CC: new baud rate FF: data format
@AABA	Read beep on alarm time response !AAHH, HH in hex, 0: disabled, 1 ~ 250: beep on alarm time in seconds, 251: beep on alarm continuously

Command	Description
@AABAHH	Set beep on alarm time HH in hex, 0: disabled, 1 ~ 250: beep on alarm time in seconds, 251: beep on alarm continuously
@AABE	Read enable/disable beep on alarm response !AAHH, HH in hex, bit 0 for channel 0, bit 1 for channel 1, etc, for each bit, 0: disabled, 1: enabled
@AABEHH	Enable/disable beep on alarm HH in hex, , bit 0 for channel 0, bit 1 for channel 1, etc, for each bit, 0: disabled, 1: enabled
@AACH	Clear all high latched analog inputs to the current values
@AACHN	Clear channel high latched analog input to the current value, N = 0 for CO, 1 for relative humidity, 2 for temperature in 0.01°C, 3 for temperature in 0.01°F, 4 for dew point temperature in 0.01°C, 5 for dew point temperature in 0.01°F
@AACHCN	Clear high latched alarm of a channel, N = 0 for CO, 1 for relative humidity, 2 for temperature in 0.01°C, 3 for temperature in 0.01°F, 4 for dew point temperature in 0.01°C, 5 for dew point temperature in 0.01°F
@AAACL	Clear all low latched analog inputs to the current values
@AAACLN	Clear channel low latched analog input to the current value, N = 0 for CO, 1 for relative humidity, 2 for temperature in 0.01°C, 3 for temperature in 0.01°F, 4 for dew point temperature in 0.01°C, 5 for dew point temperature in 0.01°F
@AAACLCN	Clear low latched alarm of a channel, N = 1 for relative humidity, 2 for temperature in 0.01°C, 3 for temperature in 0.01°F, 4 for dew point temperature in 0.01°C, 5 for dew point temperature in 0.01°F
@AADACN	Disable AI alarm of a channel, N = 0 for CO ₂ , 1 for relative humidity, 2 for temperature in 0.01°C, 3 for temperature in 0.01°F, 4 for dew point temperature in 0.01°C, 5 for dew point temperature in 0.01°F
@AADI	read DO response !AA00000
@AADLB	Read the beginning of the period setting of the data logger for period logging mode response !AAyyyymmddhhmmss,

Command	Description
@AADLByyyymmddhhmmss	Set the beginning of the period setting of the data logger for period logging mode yyyy: year, 2000 to 2199, mm: month, 01 to 12, dd: date, 01 to 31, hh: hour, 0 to 24, mm: minute, 0 to 59, ss: second, 0 to 59
@AADLC	Read the data logger command response !AAh, 0: stop, 1: run, 2: run in period mode
@AADLCh	Set the data logger command, h->0: stop, 1: run, 2: run in period mode
@AADLE	Read the ending of the period setting of the data logger for period logging mode response !AAyyyymmddhhmmss
@AADLEyyyymmddhhmmss	Set the ending of the period setting of the data logger for period logging mode yyyy: year, 2000 to 2199, mm: month, 01 to 12, dd: date, 01 to 31, hh: hour, 0 to 24, mm: minute, 0 to 59, ss: second, 0 to 59
@AADLN	Read number of log records in the data logger response !AAhhhhhhhh, hhhhhhhh in hex format
@AADLO	Read the overwriting mode when data logger is full response !AAh, 0: stop logging when full, 1: overwrite
@AADLOh	Set the overwriting mode when data logger is full h->0: stop logging when full, 1: overwrite
@AADLP	Read the samplig period setting of the data logger response !AAhhmmss, hh: hour, 0 to 24, mm: minute, 0 to 59, ss: second, 0 to 59
@AADLPhmmss	Set the samplig period setting of the data logger
@AADLS	Read logging status of the data logger response !AAhh, hh in hex format, 00: stopped, 01: running, others: error
@AADO0V	set DO, V-> 0: off, 1: on

Command	Description
@AAEATCN	Enable AI alarm of a channel, N = 0 for CO, 1 for relative humidity, 2 for temperature in 0.01°C, 3 for temperature in 0.01°F, 4 for dew point temperature in 0.01°C, 5 for dew point temperature in 0.01°F T->M: momentary alarm, L: latched alarm
@AAHI(data)CN	Set high alarm limit of an AI channel, N = 0 for CO in 1ppm, 1 for relative humidity in 0.01%, 2 for temperature in 0.01°C, 3 for temperature in 0.01°F, 4 for dew point temperature in 0.01°C, 5 for dew point temperature in 0.01°F
@AAHO	Read humidity offset
@AAHO(data)	Set humidity offset, data in format of -100.00 ~ +100.00
@AALO(data)CN	Set low alarm limit of an AI channel, N = 1 for relative humidity in 0.01%, 2 for temperature in 0.01°C, 3 for temperature in 0.01°F, 4 for dew point temperature in 0.01°C, 5 for dew point temperature in 0.01°F
@AARACN	Read AI alarm enabled/disabled status of a channel response !AAN, N->0: disabled, 1: momentary, 2: latched
@AARAO	Read AI alarm status response !AAHLL
@AARH	Read all high latched values of analog input channels
@AARHN	Read channel high latched value of analog input
@AARHCN	Read high alarm limit of an AI channel
@AARL	Read all low latched values of analog input channels
@AARLN	Read channel low latched value of analog input
@AARLCN	Read low alarm limit of an AI channel
@AART	Read RTC data response !AAYYYMMDDHHMMSS
@AARTYYYYMMDDHHMMSS	Set RTC data
@AATO	Read temperature offset in 0.01°C
@AATO(data)	Set temperature offset in 0.01°C, -100.00 ~ +100.00
~**	clear host watchdog timeout counter
~AA0	read host watchdog status
~AA1	clear host watchdog timeout status
~AA2	read host watchdog enable/disable status and timeout value

Command	Description
~AA3ETT	enable/disable host watchdog and set timeout value E-> 0: disable host watchdog, 1: enable host watchdog TT: host watchdog timeout in 0.1s in hex format
~AA4	read DO power on and safe value
~AA50P0S	set DO power on and safe value P-> 0: power on value off, 1: power on value on S-> 0: safe value off, 1: safe value on
~AARD	read response delay time in ms in hex format
~AARDVV	set response delay time in ms, VV in hex format, 00 - 1E

A-2. CL-202-E DCON Command Sets

Command	Description
\$AAF	read firmware version
\$AAI	read INIT status response: !AA0 -> INIT short to GND !AA1 -> else
\$AAM	read module name
\$AAP	Read Modbus RTU/DCON protocol response: !AA0 -> DCON !AA1 -> Modbus RTU
\$AAPN	Set Modbus RTU/DCON protocol N-> 0: DCON, 1: Modbus RTU
\$AA2	read configuration
\$AA5	read reset status !AA1 first after power on, !AA0 others
#AA	Read All Analog Inputs response > (CO ₂ in 1 ppm) (relative humidity in 0.01%)(temperature in 0.01°C)(temperature in 0.01°F) (dew point temperature in 0.01°C)(dew point temperature in 0.01°F)
#AAN	Read Channel Analog Input N = 0 for CO ₂ in 1 ppm, 1 for relative humidity in 0.01%, 2 for temperature in 0.01°C, 3 for temperature in 0.01°F, 4 for dew point temperature in 0.01°C, 5 for dew point temperature in 0.01°F
%AANNTTCCFF	set configuration, NN: new address, TT = 00, CC: new baud rate FF: data format
@AAABC	Read status of the automatic baseline correction response !AAN, N=0: disabled, 1: enabled
@AAABCN	Set the automatic baseline correction N->0: disabled, 1: enabled
@AABA	Read beep on alarm time response !AAHH, HH in hex, 0: disabled, 1 ~ 250: beep on alarm time in seconds, 251: beep on alarm continuously

Command	Description
@AABAHH	Set beep on alarm time HH in hex, 0: disabled, 1 ~ 250: beep on alarm time in seconds, 251: beep on alarm continuously
@AABE	Read enable/disable beep on alarm response !AAHH, HH in hex, bit 0 for channel 0, bit 1 for channel 1, etc, for each bit, 0: disabled, 1: enabled
@AABEHH	Enable/disable beep on alarm HH in hex, , bit 0 for channel 0, bit 1 for channel 1, etc, for each bit, 0: disabled, 1: enabled
@AACH	Clear all high latched analog inputs to the current values
@AACHN	Clear channel high latched analog input to the current value, N = 0 for CO ₂ , 1 for relative humidity, 2 for temperature in 0.01°C, 3 for temperature in 0.01°F, 4 for dew point temperature in 0.01°C, 5 for dew point temperature in 0.01°F
@AACHCN	Clear high latched alarm of a channel, N = 0 for CO ₂ , 1 for relative humidity, 2 for temperature in 0.01°C, 3 for temperature in 0.01°F, 4 for dew point temperature in 0.01°C, 5 for dew point temperature in 0.01°F
@AAACL	Clear all low latched analog inputs to the current values
@AAACLN	Clear channel low latched analog input to the current value, N = 0 for CO ₂ , 1 for relative humidity, 2 for temperature in 0.01°C, 3 for temperature in 0.01°F, 4 for dew point temperature in 0.01°C, 5 for dew point temperature in 0.01°F
@AAACLCN	Clear low latched alarm of a channel, N = 1 for relative humidity, 2 for temperature in 0.01°C, 3 for temperature in 0.01°F, 4 for dew point temperature in 0.01°C, 5 for dew point temperature in 0.01°F
@AADACN	Disable AI alarm of a channel, N = 0 for CO ₂ , 1 for relative humidity, 2 for temperature in 0.01°C, 3 for temperature in 0.01°F, 4 for dew point temperature in 0.01°C, 5 for dew point temperature in 0.01°F
@AADI	read DO response !AA00000
@AADLB	Read the beginning of the period setting of the data logger for period logging mode response !AAyyyymmddhhmmss,

Command	Description
@AADLByyyymmddhhmmss	Set the beginning of the period setting of the data logger for period logging mode yyyy: year, 2000 to 2199, mm: month, 01 to 12, dd: date, 01 to 31, hh: hour, 0 to 24, mm: minute, 0 to 59, ss: second, 0 to 59
@AADLC	Read the data logger command response !AAh, 0: stop, 1: run, 2: run in period mode
@AADLCh	Set the data logger command, h->0: stop, 1: run, 2: run in period mode
@AADLE	Read the ending of the period setting of the data logger for period logging mode response !AAyyyymmddhhmmss
@AADLEyyyymmddhhmmss	Set the ending of the period setting of the data logger for period logging mode yyyy: year, 2000 to 2199, mm: month, 01 to 12, dd: date, 01 to 31, hh: hour, 0 to 24, mm: minute, 0 to 59, ss: second, 0 to 59
@AADLN	Read number of log records in the data logger response !AAhhhhhhhh, hhhhhhhh in hex format
@AADLO	Read the overwriting mode when data logger is full response !AAh, 0: stop logging when full, 1: overwrite
@AADLOh	Set the overwriting mode when data logger is full h->0: stop logging when full, 1: overwrite
@AADLP	Read the samplig period setting of the data logger response !AAhhmmss, hh: hour, 0 to 24, mm: minute, 0 to 59, ss: second, 0 to 59
@AADLPhmmss	Set the samplig period setting of the data logger
@AADLS	Read logging status of the data logger response !AAhh, hh in hex format, 00: stopped, 01: running, others: error
@AADO0V	set DO, V-> 0: off, 1: on

Command	Description
@AAEATCN	Enable AI alarm of a channel, N = 0 for CO ₂ , 1 for relative humidity, 2 for temperature in 0.01°C, 3 for temperature in 0.01°F, 4 for dew point temperature in 0.01°C, 5 for dew point temperature in 0.01°F T->M: momentary alarm, L: latched alarm
@AAHI(data)CN	Set high alarm limit of an AI channel, N = 0 for CO ₂ in 1ppm, 1 for relative humidity in 0.01%, 2 for temperature in 0.01°C, 3 for temperature in 0.01°F, 4 for dew point temperature in 0.01°C, 5 for dew point temperature in 0.01°F
@AAHO	Read humidity offset
@AAHO(data)	Set humidity offset, data in format of -100.00 ~ +100.00
@AALO(data)CN	Set low alarm limit of an AI channel, N = 1 for relative humidity in 0.01%, 2 for temperature in 0.01°C, 3 for temperature in 0.01°F, 4 for dew point temperature in 0.01°C, 5 for dew point temperature in 0.01°F
@AARACN	Read AI alarm enabled/disabled status of a channel response !AAN, N->0: disabled, 1: momentary, 2: latched
@AARAO	Read AI alarm status response !AAHLL
@AARH	Read all high latched values of analog input channels
@AARHN	Read channel high latched value of analog input
@AARHCN	Read high alarm limit of an AI channel
@AARL	Read all low latched values of analog input channels
@AARLN	Read channel low latched value of analog input
@AARLCN	Read low alarm limit of an AI channel
@AART	Read RTC data response !AAYYYMMDDHHMMSS
@AARTYYYYMMDDHHMMSS	Set RTC data
@AATO	Read temperature offset in 0.01°C
@AATO(data)	Set temperature offset in 0.01°C, -100.00 ~ +100.00
~**	clear host watchdog timeout counter
~AA0	read host watchdog status
~AA1	clear host watchdog timeout status

~AA2	read host watchdog enable/disable status and timeout value
Command	Description
~AA3ETT	enable/disable host watchdog and set timeout value E-> 0: disable host watchdog, 1: enable host watchdog TT: host watchdog timeout in 0.1s in hex format
~AA4	read DO power on and safe value
~AA50POS	set DO power on and safe value P-> 0: power on value off, 1: power on value on S-> 0: safe value off, 1: safe value on
~AARD	read response delay time in ms in hex format
~AARDVV	set response delay time in ms, VV in hex format, 00 - 1E

A-3. CL-203-E DCON Command Sets

Command	Description
\$AAF	read firmware version
\$AAI	read INIT status response: !AA0 -> INIT short to GND !AA1 -> else
\$AAM	read module name
\$AAP	Read Modbus RTU/DCON protocol response: !AA0 -> DCON !AA1 -> Modbus RTU
\$AAPN	Set Modbus RTU/DCON protocol N-> 0: DCON, 1: Modbus RTU
\$AA2	read configuration
\$AA5	read reset status !AA1 first after power on, !AA0 others
#AA	Read All Analog Inputs response >(CO in 1 ppm) (CO ₂ in 1 ppm) (relative humidity in 0.01%)(temperature in 0.01°C)(temperature in 0.01°F) (dew point temperature in 0.01°C)(dew point temperature in 0.01°F)
#AAN	Read Channel Analog Input N = 0 for CO in 1 ppm, 1 for CO ₂ in 1 ppm, 2 for relative humidity in 0.01%, 3 for temperature in 0.01°C, 4 for temperature in 0.01°F, 5 for dew point temperature in 0.01°C, 6 for dew point temperature in 0.01°F
%AANNTTCCFF	set configuration, NN: new address, TT = 00, CC: new baud rate FF: data format
@AAABC	Read status of the automatic baseline correction response !AAN, N=0: disabled, 1: enabled
@AAABCN	Set the automatic baseline correction N->0: disabled, 1: enabled

Command	Description
@AABA	Read beep on alarm time response !AAHH, HH in hex, 0: disabled, 1 ~ 250: beep on alarm time in seconds, 251: beep on alarm continuously
@AABAHH	Set beep on alarm time HH in hex, 0: disabled, 1 ~ 250: beep on alarm time in seconds, 251: beep on alarm continuously
@AABE	Read enable/disable beep on alarm response !AAHH, HH in hex, bit 0 for channel 0, bit 1 for channel 1, etc, for each bit, 0: disabled, 1: enabled
@AABEHH	Enable/disable beep on alarm HH in hex, , bit 0 for channel 0, bit 1 for channel 1, etc, for each bit, 0: disabled, 1: enabled
@AACH	Clear all high latched analog inputs to the current values
@AACHN	Clear channel high latched analog input to the current value, N = 0 for CO, 1 for CO ₂ , 2 for relative humidity, 3 for temperature in 0.01°C, 4 for temperature in 0.01°F, 5 for dew point temperature in 0.01°C, 6 for dew point temperature in 0.01°F
@AACHCN	Clear high latched alarm of a channel, N = 0 for CO, 1 for CO ₂ , 2 for relative humidity, 3 for temperature in 0.01°C, 4 for temperature in 0.01°F, 5 for dew point temperature in 0.01°C, 6 for dew point temperature in 0.01°F
@AACL	Clear all low latched analog inputs to the current values
@AACLN	Clear channel low latched analog input to the current value, N = 0 for CO, 1 for CO ₂ , 2 for relative humidity, 3 for temperature in 0.01°C, 4 for temperature in 0.01°F, 5 for dew point temperature in 0.01°C, 6 for dew point temperature in 0.01°F
@AACL CN	Clear low latched alarm of a channel, N = 2 for relative humidity, 3 for temperature in 0.01°C, 4 for temperature in 0.01°F, 5 for dew point temperature in 0.01°C, 6 for dew point temperature in 0.01°F
@AADACN	Disable AI alarm of a channel, N = 0 for CO, 1 for CO ₂ , 2 for relative humidity, 3 for temperature in 0.01°C, 4 for temperature in 0.01°F, 5 for dew point temperature in 0.01°C, 6 for dew point temperature in 0.01°F

Command	Description
@AAID	read DO response !AA0000
@AADLB	Read the beginning of the period setting of the data logger for period logging mode response !AAyyyymmddhhmmss,
@AADLByyyyymmddhhmmss	Set the beginning of the period setting of the data logger for period logging mode yyyy: year, 2000 to 2199, mm: month, 01 to 12, dd: date, 01 to 31, hh: hour, 0 to 24, mm: minute, 0 to 59, ss: second, 0 to 59
@AADLC	Read the data logger command response !AAh, 0: stop, 1: run, 2: run in period mode
@AADLCh	Set the data logger command, h->0: stop, 1: run, 2: run in period mode
@AADLE	Read the ending of the period setting of the data logger for period logging mode response !AAyyyymmddhhmmss
@AADLEyyyymmddhhmmss	Set the ending of the period setting of the data logger for period logging mode yyyy: year, 2000 to 2199, mm: month, 01 to 12, dd: date, 01 to 31, hh: hour, 0 to 24, mm: minute, 0 to 59, ss: second, 0 to 59
@AADLN	Read number of log records in the data logger response !AAhhhhhhhh, hhhhhhhh in hex format
@AADLO	Read the overwriting mode when data logger is full response !AAh, 0: stop logging when full, 1: overwrite
@AADLOh	Set the overwriting mode when data logger is full h->0: stop logging when full, 1: overwrite
@AADLP	Read the samplig period setting of the data logger response !AAhhmmss, hh: hour, 0 to 24, mm: minute, 0 to 59, ss: second, 0 to 59

Command	Description
@AADLPhmmss	Set the samplig period setting of the data logger
@AADLS	Read logging status of the data logger response !AAhh, hh in hex format, 00: stopped, 01: running, others: error
@AADO0V	set DO, V-> 0: off, 1: on
@AAEATCN	Enable AI alarm of a channel, N = 0 for CO, 1 for CO ₂ , 2 for relative humidity, 3 for temperature in 0.01°C, 4 for temper ature in 0.01°F, 5 for dew point temperature in 0.01°C, 6 for dew poin t temperature in 0.01°F T->M: momentary alarm, L: latched alarm
@AAHI(data)CN	Set high alarm limit of an AI channel, N = 0 for CO in 1ppm, 1 for CO ₂ in 1ppm, 2 for relative humidity in 0.01%, 3 for temperature in 0.01°C, 4 for temperature in 0.01°F, 5 for dew poin t temperature in 0.01°C, 6 for dew point temperature in 0.01°F
@AAHO	Read humidity offset
@AAHO(data)	Set humidity offset, data in format of -100.00 ~ +100.00
@AALO(data)CN	Set low alarm limit of an AI channel, N = 2 for relative humidity in 0.01%, 3 for temperature in 0.01°C, 4 for temperatu re in 0.01°F, 5 for dew point temperature in 0.01°C, 6 for dew poin t temperature in 0.01°F
@AARACN	Read AI alarm enabled/disabled status of a channel response !AAN, N->0: disabled, 1: momentary, 2: latched
@AARAO	Read AI alarm status response !AAHLL
@AARH	Read all high latched values of analog input channels
@AARHN	Read channel high latched value of analog input
@AARHCN	Read high alarm limit of an AI channel
@AARL	Read all low latched values of analog input channels
@AARLN	Read channel low latched value of analog input
@AARLCN	Read low alarm limit of an AI channel
@AART	Read RTC data response !AAYYYMMDDHHMMSS
@AARTYYYYMMDDHHMMSS	Set RTC data

Command	Description
@AATO	Read temperature offset in 0.01°C
@AATO(data)	Set temperature offset in 0.01°C, -100.00 ~ +100.00
~**	clear host watchdog timeout counter
~AA0	read host watchdog status
~AA1	clear host watchdog timeout status
~AA2	read host watchdog enable/disable status and timeout value
~AA3ETT	enable/disable host watchdog and set timeout value E-> 0: disable host watchdog, 1: enable host watchdog TT: host watchdog timeout in 0.1s in hex format
~AA4	read DO power on and safe value
~AA50POS	set DO power on and safe value P-> 0: power on value off, 1: power on value on S-> 0: safe value off, 1: safe value on
~AARD	read response delay time in ms in hex format
~AARDVV	set response delay time in ms, VV in hex format, 00 - 1E

A-4. CL-204-E DCON Command Sets

Command	Description
\$AAF	read firmware version
\$AAI	read INIT status response: !AA0 -> INIT short to GND !AA1 -> else
\$AAM	read module name
\$AAP	Read Modbus RTU/DCON protocol response: !AA0 -> DCON !AA1 -> Modbus RTU
\$AAPN	Set Modbus RTU/DCON protocol N-> 0: DCON, 1: Modbus RTU
\$AA2	read configuration
\$AA5	read reset status !AA1 first after power on, !AA0 others
#AA	Read All Analog Inputs response >(HCHO in 1 ppb) (TVOC in 1 ppb) (relative humidity in 0.01%)(temperature in 0.01°C)(temperature in 0.01°F) (dew point temperature in 0.01°C)(dew point temperature in 0.01°F)
#AAN	Read Channel Analog Input N = 0 for HCHO in 1 ppb, 1 for TVOC in 1 ppb, 2 for relative humidity in 0.01%, 3 for temperature in 0.01°C, 4 for temperature in 0.01°F, 5 for dew point temperature in 0.01°C, 6 for dew point temperature in 0.01°F
%AANNTTCCFF	set configuration, NN: new address, TT = 00, CC: new baud rate FF: data format
@AABA	Read beep on alarm time response !AAHH, HH in hex, 0: disabled, 1 ~ 250: beep on alarm time in seconds, 251: beep on alarm continuously
@AABAHH	Set beep on alarm time HH in hex, 0: disabled, 1 ~ 250: beep on alarm time in seconds, 251: beep on alarm continuously

Command	Description
@AABE	Read enable/disable beep on alarm response !AAHH, HH in hex, bit 0 for channel 0, bit 1 for channel 1, etc, for each bit, 0: disabled, 1: enabled
@AABEHH	Enable/disable beep on alarm HH in hex, , bit 0 for channel 0, bit 1 for channel 1, etc, for each bit, 0: disabled, 1: enabled
@AACH	Clear all high latched analog inputs to the current values
@AACHN	Clear channel high latched analog input to the current value, N = 0 for HCHO, 1 for TVOC, 2 for relative humidity, 3 for temperature in 0.01°C, 4 for temperature in 0.01°F, 5 for dew point temperature in 0.01°C, 6 for dew point temperature in 0.01°F
@AACHCN	Clear high latched alarm of a channel, N = 0 for HCHO, 1 for TVOC, 2 for relative humidity, 3 for temperature in 0.01°C, 4 for temperature in 0.01°F, 5 for dew point temperature in 0.01°C, 6 for dew point temperature in 0.01°F
@AACL	Clear all low latched analog inputs to the current values
@AACLN	Clear channel low latched analog input to the current value, N = 0 for HCHO, 1 for TVOC, 2 for relative humidity, 3 for temperature in 0.01°C, 4 for temperature in 0.01°F, 5 for dew point temperature in 0.01°C, 6 for dew point temperature in 0.01°F
@AACL CN	Clear low latched alarm of a channel, N = 2 for relative humidity, 3 for temperature in 0.01°C, 4 for temperature in 0.01°F, 5 for dew point temperature in 0.01°C, 6 for dew point temperature in 0.01°F
@AADACN	Disable AI alarm of a channel, N = 0 for HCHO, 1 for TVOC, 2 for relative humidity, 3 for temperature in 0.01°C, 4 for temperature in 0.01°F, 5 for dew point temperature in 0.01°C, 6 for dew point temperature in 0.01°F
@AADI	read DO response !AA00000
@AADLB	Read the beginning of the period setting of the data logger for period logging mode response !AAyyyymmddhhmmss,

Command	Description
@AADLByyyymmddhhmmss	Set the beginning of the period setting of the data logger for period logging mode yyyy: year, 2000 to 2199, mm: month, 01 to 12, dd: date, 01 to 31, hh: hour, 0 to 24, mm: minute, 0 to 59, ss: second, 0 to 59
@AADLC	Read the data logger command response !AAh, 0: stop, 1: run, 2: run in period mode
@AADLCh	Set the data logger command, h->0: stop, 1: run, 2: run in period mode
@AADLE	Read the ending of the period setting of the data logger for period logging mode response !AAyyyymmddhhmmss
@AADLEyyyymmddhhmmss	Set the ending of the period setting of the data logger for period logging mode yyyy: year, 2000 to 2199, mm: month, 01 to 12, dd: date, 01 to 31, hh: hour, 0 to 24, mm: minute, 0 to 59, ss: second, 0 to 59
@AADLN	Read number of log records in the data logger response !AAhhhhhhhh, hhhhhhhh in hex format
@AADLO	Read the overwriting mode when data logger is full response !AAh, 0: stop logging when full, 1: overwrite
@AADLOh	Set the overwriting mode when data logger is full h->0: stop logging when full, 1: overwrite
@AADLP	Read the sampling period setting of the data logger response !AAhhmmss, hh: hour, 0 to 24, mm: minute, 0 to 59, ss: second, 0 to 59
@AADLPhmmss	Set the sampling period setting of the data logger
@AADLS	Read logging status of the data logger response !AAhh, hh in hex format, 00: stopped, 01: running, others: error
@AADO0V	set DO, V-> 0: off, 1: on

Command	Description
@AAEATCN	Enable AI alarm of a channel, N = 0 for HCHO, 1 for TVOC, 2 for relative humidity, 3 for temperature in 0.01°C, 4 for temperature in 0.01°F, 5 for dew point temperature in 0.01°C, 6 for dew point temperature in 0.01°F T->M: momentary alarm, L: latched alarm
@AAH2	Read HCHO offset
@AAH2(data)	Set HCHO offset, data in format of +00000. ~ +01999.
@AAHI(data)CN	Set high alarm limit of an AI channel, N = 0 for HCHO in 1ppm, 1 for TVOC in 1ppm, 2 for relative humidity in 0.01%, 3 for temperature in 0.01°C, 4 for temperature in 0.01°F, 5 for dew point temperature in 0.01°C, 6 for dew point temperature in 0.01°F
@AAHO	Read humidity offset
@AAHO(data)	Set humidity offset, data in format of -100.00 ~ +100.00
@AALO(data)CN	Set low alarm limit of an AI channel, N = 2 for relative humidity in 0.01%, 3 for temperature in 0.01°C, 4 for temperature in 0.01°F, 5 for dew point temperature in 0.01°C, 6 for dew point temperature in 0.01°F
@AARACN	Read AI alarm enabled/disabled status of a channel response !AAN, N->0: disabled, 1: momentary, 2: latched
@AARAO	Read AI alarm status response !AAHLL
@AARH	Read all high latched values of analog input channels
@AARHN	Read channel high latched value of analog input
@AARHCN	Read high alarm limit of an AI channel
@AARL	Read all low latched values of analog input channels
@AARLN	Read channel low latched value of analog input
@AARLCN	Read low alarm limit of an AI channel
@AART	Read RTC data response !AAYYYMMDDHHMMSS
@AARTYYYYMMDDHHMMSS	Set RTC data
@AATO	Read temperature offset in 0.01°C
@AATO(data)	Set temperature offset in 0.01°C, -100.00 ~ +100.00
@AAVO	Read TVOC offset

Command	Description
@AAVO(data)	Set TVOC offset, data in format of +00000. ~ +01999.
~**	clear host watchdog timeout counter
~AA0	read host watchdog status
~AA1	clear host watchdog timeout status
~AA2	read host watchdog enable/disable status and timeout value
~AA3ETT	enable/disable host watchdog and set timeout value E-> 0: disable host watchdog, 1: enable host watchdog TT: host watchdog timeout in 0.1s in hex format
~AA4	read DO power on and safe value
~AA50POS	set DO power on and safe value P-> 0: power on value off, 1: power on value on S-> 0: safe value off, 1: safe value on
~AARD	read response delay time in ms in hex format
~AARDVV	set response delay time in ms, VV in hex format, 00 - 1E

A-5. CL-205-E DCON Command Sets

Command	Description
\$AAF	read firmware version
\$AAI	read INIT status response: !AA0 -> INIT short to GND !AA1 -> else
\$AAM	read module name
\$AAP	Read Modbus RTU/DCON protocol response: !AA0 -> DCON !AA1 -> Modbus RTU
\$AAPN	Set Modbus RTU/DCON protocol N-> 0: DCON, 1: Modbus RTU
\$AA2	read configuration
\$AA5	read reset status !AA1 first after power on, !AA0 others
#AA	Read All Analog Inputs response > (NH ₃ in 1 ppm) (relative humidity in 0.01%)(temperature in 0.01 °C)(temperature in 0.01 °F) (dew point temperature in 0.01 °C)(dew point temperature in 0.01 °F)
#AAN	Read Channel Analog Input N = 0 for NH ₃ in 1 ppm, 1 for relative humidity in 0.01%, 2 for temperature in 0.01 °C, 3 for temperature in 0.01 °F, 4 for dew point temperature in 0.01 °C, 5 for dew point temperature in 0.01 °F
%AANNTTCCFF	set configuration, NN: new address, TT = 00, CC: new baud rate FF: data format
@AABA	Read beep on alarm time response !AAHH, HH in hex, 0: disabled, 1 ~ 250: beep on alarm time in seconds, 251: beep on alarm continuously
@AABAHH	Set beep on alarm time HH in hex, 0: disabled, 1 ~ 250: beep on alarm time in seconds, 251: beep on alarm continuously

Command	Description
@AABE	Read enable/disable beep on alarm response !AAHH, HH in hex, bit 0 for channel 0, bit 1 for channel 1, etc, for each bit, 0: disabled, 1: enabled
@AABEHH	Enable/disable beep on alarm HH in hex, , bit 0 for channel 0, bit 1 for channel 1, etc, for each bit, 0: disabled, 1: enabled
@AACH	Clear all high latched analog inputs to the current values
@AACHN	Clear channel high latched analog input to the current value, N = 0 for NH3, 1 for relative humidity, 2 for temperature in 0.01°C, 3 for temperature in 0.01°F, 4 for dew point temperature in 0.01°C, 5 for dew point temperature in 0.01°F
@AACHCN	Clear high latched alarm of a channel, N = 0 for NH3, 1 for relative humidity, 2 for temperature in 0.01°C, 3 for temperature in 0.01°F, 4 for dew point temperature in 0.01°C, 5 for dew point temperature in 0.01°F
@AACL	Clear all low latched analog inputs to the current values
@AACLN	Clear channel low latched analog input to the current value, N = 0 for NH3, 1 for relative humidity, 2 for temperature in 0.01°C, 3 for temperature in 0.01°F, 4 for dew point temperature in 0.01°C, 5 for dew point temperature in 0.01°F
@AACL CN	Clear low latched alarm of a channel, N = 1 for relative humidity, 2 for temperature in 0.01°C, 3 for temperature in 0.01°F, 4 for dew point temperature in 0.01°C, 5 for dew point temperature in 0.01°F
@AADACN	Disable AI alarm of a channel, N = 0 for NH3, 1 for relative humidity, 2 for temperature in 0.01°C, 3 for temperature in 0.01°F, 4 for dew point temperature in 0.01°C, 5 for dew point temperature in 0.01°F
@AADI	read DO response !AA00000
@AADLB	Read the beginning of the period setting of the data logger for period logging mode response !AAyyyymmddhhmmss,
@AADLByyyyymmddhhmmss	Set the beginning of the period setting of the data logger for period logging mode yyyy: year, 2000 to 2199, mm: month, 01 to 12, dd: date, 01 to 31, hh: hour, 0 to 24, mm: minute, 0 to 59, ss: second, 0 to 59

Command	Description
@AADLC	Read the data logger command response !AAh, 0: stop, 1: run, 2: run in period mode
@AADLCh	Set the data logger command, h->0: stop, 1: run, 2: run in period mode
@AADLE	Read the ending of the period setting of the data logger for period logging mode response !AAyyyymmddhhmmss
@AADLEyyyymmddhhmmss	Set the ending of the period setting of the data logger for period logging mode yyyy: year, 2000 to 2199, mm: month, 01 to 12, dd: date, 01 to 31, hh: hour, 0 to 24, mm: minute, 0 to 59, ss: second, 0 to 59
@AADLN	Read number of log records in the data logger response !AAhhhhhhhh, hhhhhhhh in hex format
@AADLO	Read the overwriting mode when data logger is full response !AAh, 0: stop logging when full, 1: overwrite
@AADLOh	Set the overwriting mode when data logger is full h->0: stop logging when full, 1: overwrite
@AADLP	Read the sampling period setting of the data logger response !AAhhmmss, hh: hour, 0 to 24, mm: minute, 0 to 59, ss: second, 0 to 59
@AADLPPhmmss	Set the sampling period setting of the data logger
@AADLS	Read logging status of the data logger response !AAhh, hh in hex format, 00: stopped, 01: running, others: error
@AADO0V	set DO, V-> 0: off, 1: on
@AAEATCN	Enable AI alarm of a channel, N = 0 for NH3, 1 for relative humidity, 2 for temperature in 0.01°C, 3 for temperature in 0.01°F, 4 for dew point temperature in 0.01°C, 5 for dew point temperature in 0.01°F T->M: momentary alarm, L: latched alarm

Command	Description
@AAFN	Read fan status Response !AAE, E=0: fan off, 1: fan on,
@AAFNE	Turn fan on or off E=0: fan off, 1: fan on
@AAFNPi	Read the ith fan off period in a day, i = 0 to 5 response !AAbhbmehem, bh: beginning hour, bm: beginning minute, eh: ending hour, em: ending minute.
@AAFNPibhbmehe m	Set the ith fan off period in a day, i = 0 to 5, bh: beginning hour, 0 to 23, bm: beginning minute, 0 to 59, eh: ending hour, 0 to 23, em: ending minute, 0 to 59. The beginning hour/minute should be earlier than the ending hour/minute. Otherwise, the setting is ignored. If all of the six period settings are invalid, then the fan is controlled by the @AAFNE command.
@AAHI(data)CN	Set high alarm limit of an AI channel, N = 0 for NH3 in 1 ppm, 1 for relative humidity in 0.01%, 2 for temperature in 0.01°C, 3 for temperature in 0.01°F, 4 for dew point temperature in 0.01°C, 5 for dew point temperature in 0.01°F
@AAHO	Read humidity offset
@AAHO(data)	Set humidity offset, data in format of -100.00 ~ +100.00
@AALO(data)CN	Set low alarm limit of an AI channel, N = 1 for relative humidity in 0.01%, 2 for temperature in 0.01°C, 3 for temperature in 0.01°F, 4 for dew point temperature in 0.01°C, 5 for dew point temperature in 0.01°F
@AANO	Read NH3 offset
@AANO(data)	Set NH3 offset, data in format of -00100. ~ +00100.
@AARACN	Read AI alarm enabled/disabled status of a channel response !AAN, N->0: disabled, 1: momentary, 2: latched
@AARAO	Read AI alarm status response !AAHLL
@AARH	Read all high latched values of analog input channels
@AARHN	Read channel high latched value of analog input
@AARHCN	Read high alarm limit of an AI channel
@AARL	Read all low latched values of analog input channels
@AARLN	Read channel low latched value of analog input

Command	Description
@AARLCN	Read low alarm limit of an AI channel
@AART	Read RTC data response !AAYYYMMDDHHMMSS
@AARTYYYYMMDDHHMMSS	Set RTC data
@AATO	Read temperature offset in 0.01°C
@AATO(data)	Set temperature offset in 0.01°C, -100.00 ~ +100.00
~**	clear host watchdog timeout counter
~AA0	read host watchdog status
~AA1	clear host watchdog timeout status
~AA2	read host watchdog enable/disable status and timeout value
~AA3ETT	enable/disable host watchdog and set timeout value E-> 0: disable host watchdog, 1: enable host watchdog TT: host watchdog timeout in 0.1s in hex format
~AA4	read DO power on and safe value
~AA50P0S	set DO power on and safe value P-> 0: power on value off, 1: power on value on S-> 0: safe value off, 1: safe value on
~AARD	read response delay time in ms in hex format
~AARDVV	set response delay time in ms, VV in hex format, 00 - 1E

A-6. CL-206-E DCON Command Sets

Command	Description
\$AAF	read firmware version
\$AAI	read INIT status response: !AA0 -> INIT short to GND !AA1 -> else
\$AAM	read module name
\$AAP	Read Modbus RTU/DCON protocol response: !AA0 -> DCON !AA1 -> Modbus RTU
\$AAPN	Set Modbus RTU/DCON protocol N-> 0: DCON, 1: Modbus RTU
\$AA2	read configuration
\$AA5	read reset status !AA1 first after power on, !AA0 others
#AA	Read All Analog Inputs response > (H ₂ S in 1 ppm) (relative humidity in 0.01%)(temperature in 0.01°C)(temperature in 0.01°F) (dew point temperature in 0.01°C)(dew point temperature in 0.01°F)
#AAN	Read Channel Analog Input N = 0 for H ₂ S in 1 ppm, 1 for relative humidity in 0.01%, 2 for temperature in 0.01°C, 3 for temperature in 0.01°F, 4 for dew point temperature in 0.01°C, 5 for dew point temperature in 0.01°F
%AANNTTCCFF	set configuration, NN: new address, TT = 00, CC: new baud rate FF: data format
@AABA	Read beep on alarm time response !AAHH, HH in hex, 0: disabled, 1 ~ 250: beep on alarm time in seconds, 251: beep on alarm continuously
@AABAHH	Set beep on alarm time HH in hex, 0: disabled, 1 ~ 250: beep on alarm time in seconds, 251: beep on alarm continuously

Command	Description
@AABE	Read enable/disable beep on alarm response !AAHH, HH in hex, bit 0 for channel 0, bit 1 for channel 1, etc, for each bit, 0: disabled, 1: enabled
@AABEHH	Enable/disable beep on alarm HH in hex, , bit 0 for channel 0, bit 1 for channel 1, etc, for each bit, 0: disabled, 1: enabled
@AACH	Clear all high latched analog inputs to the current values
@AACHN	Clear channel high latched analog input to the current value, N = 0 for H2S, 1 for relative humidity, 2 for temperature in 0.01°C, 3 for temperature in 0.01°F, 4 for dew point temperature in 0.01°C, 5 for dew point temperature in 0.01°F
@AACHCN	Clear high latched alarm of a channel, N = 0 for H2S, 1 for relative humidity, 2 for temperature in 0.01°C, 3 for temperature in 0.01°F, 4 for dew point temperature in 0.01°C, 5 for dew point temperature in 0.01°F
@AACL	Clear all low latched analog inputs to the current values
@AACLN	Clear channel low latched analog input to the current value, N = 0 for H2S, 1 for relative humidity, 2 for temperature in 0.01°C, 3 for temperature in 0.01°F, 4 for dew point temperature in 0.01°C, 5 for dew point temperature in 0.01°F
@AACL CN	Clear low latched alarm of a channel, N = 1 for relative humidity, 2 for temperature in 0.01°C, 3 for temperature in 0.01°F, 4 for dew point temperature in 0.01°C, 5 for dew point temperature in 0.01°F
@AADACN	Disable AI alarm of a channel, N = 0 for H2S, 1 for relative humidity, 2 for temperature in 0.01°C, 3 for temperature in 0.01°F, 4 for dew point temperature in 0.01°C, 5 for dew point temperature in 0.01°F
@AADI	read DO response !AA00000
@AADLB	Read the beginning of the period setting of the data logger for period logging mode response !AAyyyymmddhhmmss,
@AADLByyyyymmddhhmmss	Set the beginning of the period setting of the data logger for period logging mode yyyy: year, 2000 to 2199, mm: month, 01 to 12, dd: date, 01 to 31, hh: hour, 0 to 24, mm: minute, 0 to 59, ss: second, 0 to 59

Command	Description
@AADLC	Read the data logger command response !AAh, 0: stop, 1: run, 2: run in period mode
@AADLCh	Set the data logger command, h->0: stop, 1: run, 2: run in period mode
@AADLE	Read the ending of the period setting of the data logger for period logging mode response !AAyyyymmddhhmmss
@AADLEyyyymmddhhmmss	Set the ending of the period setting of the data logger for period logging mode yyyy: year, 2000 to 2199, mm: month, 01 to 12, dd: date, 01 to 31, hh: hour, 0 to 24, mm: minute, 0 to 59, ss: second, 0 to 59
@AADLN	Read number of log records in the data logger response !AAhhhhhhhh, hhhhhhhh in hex format
@AADLO	Read the overwriting mode when data logger is full response !AAh, 0: stop logging when full, 1: overwrite
@AADLOh	Set the overwriting mode when data logger is full h->0: stop logging when full, 1: overwrite
@AADLP	Read the sampling period setting of the data logger response !AAhhmmss, hh: hour, 0 to 24, mm: minute, 0 to 59, ss: second, 0 to 59
@AADLPPhmmss	Set the sampling period setting of the data logger
@AADLS	Read logging status of the data logger response !AAhh, hh in hex format, 00: stopped, 01: running, others: error
@AADO0V	set DO, V-> 0: off, 1: on
@AAEATCN	Enable AI alarm of a channel, N = 0 for H2S, 1 for relative humidity, 2 for temperature in 0.01°C, 3 for temperature in 0.01°F, 4 for dew point temperature in 0.01°C, 5 for dew point temperature in 0.01°F T->M: momentary alarm, L: latched alarm

Command	Description
@AAFN	Read fan status Response !AAE, E=0: fan off, 1: fan on,
@AAFNE	Turn fan on or off E=0: fan off, 1: fan on
@AAFNPi	Read the ith fan off period in a day, i = 0 to 5 response !AAbhbmehem, bh: beginning hour, bm: beginning minute, eh: ending hour, em: ending minute.
@AAFNPibhbmehe m	Set the ith fan off period in a day, i = 0 to 5, bh: beginning hour, 0 to 23, bm: beginning minute, 0 to 59, eh: ending hour, 0 to 23, em: ending minute, 0 to 59. The beginning hour/minute should be earlier than the ending hour/minute. Otherwise, the setting is ignored. If all of the six period settings are invalid, then the fan is controlled by the @AAFNE command.
@AAHI(data)CN	Set high alarm limit of an AI channel, N = 0 for H2S in 1 ppm, 1 for relative humidity in 0.01%, 2 for temperature in 0.01°C, 3 for temperature in 0.01°F, 4 for dew point temperature in 0.01°C, 5 for dew point temperature in 0.01°F
@AAHO	Read humidity offset
@AAHO(data)	Set humidity offset, data in format of -100.00 ~ +100.00
@AALO(data)CN	Set low alarm limit of an AI channel, N = 1 for relative humidity in 0.01%, 2 for temperature in 0.01°C, 3 for temperature in 0.01°F, 4 for dew point temperature in 0.01°C, 5 for dew point temperature in 0.01°F
@AARACN	Read AI alarm enabled/disabled status of a channel response !AAN, N->0: disabled, 1: momentary, 2: latched
@AARAO	Read AI alarm status response !AAHLL
@AARH	Read all high latched values of analog input channels
@AARHN	Read channel high latched value of analog input
@AARHCN	Read high alarm limit of an AI channel
@AARL	Read all low latched values of analog input channels
@AARLN	Read channel low latched value of analog input
@AARLCN	Read low alarm limit of an AI channel

Command	Description
@AART	Read RTC data response !AAYYYMMDDHHMMSS
@AARTYYYYMMDDHHMMSS	Set RTC data
@AASO	Read H2S offset
@AASO(data)	Set H2S offset, data in format of -00100. ~ +00100.
@AATO	Read temperature offset in 0.01°C
@AATO(data)	Set temperature offset in 0.01°C, -100.00 ~ +100.00
~**	clear host watchdog timeout counter
~AA0	read host watchdog status
~AA1	clear host watchdog timeout status
~AA2	read host watchdog enable/disable status and timeout value
~AA3ETT	enable/disable host watchdog and set timeout value E-> 0: disable host watchdog, 1: enable host watchdog TT: host watchdog timeout in 0.1s in hex format
~AA4	read DO power on and safe value
~AA50POS	set DO power on and safe value P-> 0: power on value off, 1: power on value on S-> 0: safe value off, 1: safe value on
~AARD	read response delay time in ms in hex format
~AARDVV	set response delay time in ms, VV in hex format, 00 - 1E

A-7. CL-207-E DCON Command Sets

Command	Description
\$AAF	read firmware version
\$AAI	read INIT status response: !AA0 -> INIT short to GND !AA1 -> else
\$AAM	read module name
\$AAP	Read Modbus RTU/DCON protocol response: !AA0 -> DCON !AA1 -> Modbus RTU
\$AAPN	Set Modbus RTU/DCON protocol N-> 0: DCON, 1: Modbus RTU
\$AA2	read configuration
\$AA5	read reset status !AA1 first after power on, !AA0 others
#AA	Read All Analog Inputs response > (HCHO in 1 ppb) (relative humidity in 0.01%)(temperature in 0.01°C)(temperature in 0.01°F) (dew point temperature in 0.01°C)(dew point temperature in 0.01°F)
#AAN	Read Channel Analog Input N = 0 for HCHO in 1 ppb, 1 for relative humidity in 0.01%, 2 for temperature in 0.01°C, 3 for temperature in 0.01°F, 4 for dew point temperature in 0.01°C, 5 for dew point temperature in 0.01°F
%AANNTTCCFF	set configuration, NN: new address, TT = 00, CC: new baud rate FF: data format
@AABA	Read beep on alarm time response !AAHH, HH in hex, 0: disabled, 1 ~ 250: beep on alarm time in seconds, 251: beep on alarm continuously
@AABAHH	Set beep on alarm time HH in hex, 0: disabled, 1 ~ 250: beep on alarm time in seconds, 251: beep on alarm continuously

Command	Description
@AABE	Read enable/disable beep on alarm response !AAHH, HH in hex, bit 0 for channel 0, bit 1 for channel 1, etc, for each bit, 0: disabled, 1: enabled
@AABEHH	Enable/disable beep on alarm HH in hex, , bit 0 for channel 0, bit 1 for channel 1, etc, for each bit, 0: disabled, 1: enabled
@AACH	Clear all high latched analog inputs to the current values
@AACHN	Clear channel high latched analog input to the current value, N = 0 for HCHO, 1 for relative humidity, 2 for temperature in 0.01°C, 3 for temperature in 0.01°F, 4 for dew point temperature in 0.01°C, 5 for dew point temperature in 0.01°F
@AACHCN	Clear high latched alarm of a channel, N = 0 for HCHO, 1 for relative humidity, 2 for temperature in 0.01°C, 3 for temperature in 0.01°F, 4 for dew point temperature in 0.01°C, 5 for dew point temperature in 0.01°F
@AACL	Clear all low latched analog inputs to the current values
@AACLN	Clear channel low latched analog input to the current value, N = 0 for HCHO, 1 for relative humidity, 2 for temperature in 0.01°C, 3 for temperature in 0.01°F, 4 for dew point temperature in 0.01°C, 5 for dew point temperature in 0.01°F
@AACL CN	Clear low latched alarm of a channel, N = 1 for relative humidity, 2 for temperature in 0.01°C, 3 for temperature in 0.01°F, 4 for dew point temperature in 0.01°C, 5 for dew point temperature in 0.01°F
@AADACN	Disable AI alarm of a channel, N = 0 for HCHO 1 for relative humidity, 2 for temperature in 0.01°C, 3 for temperature in 0.01°F, 4 for dew point temperature in 0.01°C, 5 for dew point temperature in 0.01°F
@AADI	read DO response !AA00000
@AADLB	Read the beginning of the period setting of the data logger for period logging mode response !AAyyyymmddhhmmss,

Command	Description
@AADLByyyymmddhhmmss	Set the beginning of the period setting of the data logger for period logging mode yyyy: year, 2000 to 2199, mm: month, 01 to 12, dd: date, 01 to 31, hh: hour, 0 to 24, mm: minute, 0 to 59, ss: second, 0 to 59
@AADLC	Read the data logger command response !AAh, 0: stop, 1: run, 2: run in period mode
@AADLCh	Set the data logger command, h->0: stop, 1: run, 2: run in period mode
@AADLE	Read the ending of the period setting of the data logger for period logging mode response !AAyyyymmddhhmmss
@AADLEyyyymmddhhmmss	Set the ending of the period setting of the data logger for period logging mode yyyy: year, 2000 to 2199, mm: month, 01 to 12, dd: date, 01 to 31, hh: hour, 0 to 24, mm: minute, 0 to 59, ss: second, 0 to 59
@AADLN	Read number of log records in the data logger response !AAhhhhhhhh, hhhhhhhh in hex format
@AADLO	Read the overwriting mode when data logger is full response !AAh, 0: stop logging when full, 1: overwrite
@AADLOh	Set the overwriting mode when data logger is full h->0: stop logging when full, 1: overwrite
@AADLP	Read the sampling period setting of the data logger response !AAhhmmss, hh: hour, 0 to 24, mm: minute, 0 to 59, ss: second, 0 to 59
@AADLPhmmss	Set the sampling period setting of the data logger
@AADLS	Read logging status of the data logger response !AAhh, hh in hex format, 00: stopped, 01: running, others: error
@AADO0V	set DO, V-> 0: off, 1: on

Command	Description
@AAEATCN	Enable AI alarm of a channel, N = 0 for HCHO, 1 for relative humidity, 2 for temperature in 0.01°C, 3 for temperature in 0.01°F, 4 for dew point temperature in 0.01°C, 5 for dew point temperature in 0.01°F T->M: momentary alarm, L: latched alarm
@AAFN	Read fan status Response !AAE, E=0: fan off, 1: fan on,
@AAFNE	Turn fan on or off E=0: fan off, 1: fan on
@AAFNPi	Read the ith fan off period in a day, i = 0 to 5 response !AAbhbmehem, bh: beginning hour, bm: beginning minute, eh: ending hour, em: ending minute.
@AAFNPibhbmehem	Set the ith fan off period in a day, i = 0 to 5, bh: beginning hour, 0 to 23, bm: beginning minute, 0 to 59, eh: ending hour, 0 to 23, em: ending minute, 0 to 59. The beginning hour/minute should be earlier than the ending hour/minute. Otherwise, the setting is ignored. If all of the six period settings are invalid, then the fan is controlled by the @AAFNE command.
@AAHI(data)CN	Set high alarm limit of an AI channel, N = 0 for HCHO in 1 ppb, 1 for relative humidity in 0.01%, 2 for temperature in 0.01°C, 3 for temperature in 0.01°F, 4 for dew point temperature in 0.01°C, 5 for dew point temperature in 0.01°F
@AAHO	Read humidity offset
@AAHO(data)	Set humidity offset, data in format of -100.00 ~ +100.00
@AALO(data)CN	Set low alarm limit of an AI channel, N = 1 for relative humidity in 0.01%, 2 for temperature in 0.01°C, 3 for temperature in 0.01°F, 4 for dew point temperature in 0.01°C, 5 for dew point temperature in 0.01°F
@AARACN	Read AI alarm enabled/disabled status of a channel response !AAN, N->0: disabled, 1: momentary, 2: latched
@AARAO	Read AI alarm status response !AAHLL

Command	Description
@AARH	Read all high latched values of analog input channels
@AARHN	Read channel high latched value of analog input
@AARHCN	Read high alarm limit of an AI channel
@AARL	Read all low latched values of analog input channels
@AARLN	Read channel low latched value of analog input
@AARLCN	Read low alarm limit of an AI channel
@AART	Read RTC data response !AAYYYYMMDDHHMMSS
@AARTYYYYMMDDHHMMSS	Set RTC data
@AAH2	Read HCHO offset
@AAH2(data)	Set HCHO offset, data in format of -00100. ~ +00100.
@AATO	Read temperature offset in 0.01°C
@AATO(data)	Set temperature offset in 0.01°C, -100.00 ~ +100.00
~**	clear host watchdog timeout counter
~AA0	read host watchdog status
~AA1	clear host watchdog timeout status
~AA2	read host watchdog enable/disable status and timeout value
~AA3ETT	enable/disable host watchdog and set timeout value E-> 0: disable host watchdog, 1: enable host watchdog TT: host watchdog timeout in 0.1s in hex format
~AA4	read DO power on and safe value
~AA50POS	set DO power on and safe value P-> 0: power on value off, 1: power on value on S-> 0: safe value off, 1: safe value on
~AARD	read response delay time in ms in hex format
~AARDVV	set response delay time in ms, VV in hex format, 00 - 1E

A-8. CL-208-E DCON Command Sets

Command	Description
\$AAF	read firmware version
\$AAI	read INIT status response: !AA0 -> INIT short to GND !AA1 -> else
\$AAM	read module name
\$AAP	Read Modbus RTU/DCON protocol response: !AA0 -> DCON !AA1 -> Modbus RTU
\$AAPN	Set Modbus RTU/DCON protocol N-> 0: DCON, 1: Modbus RTU
\$AA2	read configuration
\$AA5	read reset status !AA1 first after power on, !AA0 others
#AA	Read All Analog Inputs response > (TVOC in 1 ppb) (relative humidity in 0.01%)(temperature in 0.01°C)(temperature in 0.01°F) (dew point temperature in 0.01°C)(dew point temperature in 0.01°F)
#AAN	Read Channel Analog Input N = 0 for TVOC in 1 ppb, 1 for relative humidity in 0.01%, 2 for temperature in 0.01°C, 3 for temperature in 0.01°F, 4 for dew point temperature in 0.01°C, 5 for dew point temperature in 0.01°F
%AANNTTCCFF	set configuration, NN: new address, TT = 00, CC: new baud rate FF: data format
@AABA	Read beep on alarm time response !AAHH, HH in hex, 0: disabled, 1 ~ 250: beep on alarm time in seconds, 251: beep on alarm continuously
@AABAHH	Set beep on alarm time HH in hex, 0: disabled, 1 ~ 250: beep on alarm time in seconds, 251: beep on alarm continuously

Command	Description
@AABE	Read enable/disable beep on alarm response !AAHH, HH in hex, bit 0 for channel 0, bit 1 for channel 1, etc, for each bit, 0: disabled, 1: enabled
@AABEHH	Enable/disable beep on alarm HH in hex, , bit 0 for channel 0, bit 1 for channel 1, etc, for each bit, 0: disabled, 1: enabled
@AACH	Clear all high latched analog inputs to the current values
@AACHN	Clear channel high latched analog input to the current value, N = 0 for TVOC, 1 for relative humidity, 2 for temperature in 0.01°C, 3 for temperature in 0.01°F, 4 for dew point temperature in 0.01°C, 5 for dew point temperature in 0.01°F
@AACHCN	Clear high latched alarm of a channel, N = 0 for TVOC, 1 for relative humidity, 2 for temperature in 0.01°C, 3 for temperature in 0.01°F, 4 for dew point temperature in 0.01°C, 5 for dew point temperature in 0.01°F
@AACL	Clear all low latched analog inputs to the current values
@AACLN	Clear channel low latched analog input to the current value, N = 0 for TVOC, 1 for relative humidity, 2 for temperature in 0.01°C, 3 for temperature in 0.01°F, 4 for dew point temperature in 0.01°C, 5 for dew point temperature in 0.01°F
@AACL CN	Clear low latched alarm of a channel, N = 1 for relative humidity, 2 for temperature in 0.01°C, 3 for temperature in 0.01°F, 4 for dew point temperature in 0.01°C, 5 for dew point temperature in 0.01°F
@AADACN	Disable AI alarm of a channel, N = 0 for TVOC 1 for relative humidity, 2 for temperature in 0.01°C, 3 for temperature in 0.01°F, 4 for dew point temperature in 0.01°C, 5 for dew point temperature in 0.01°F
@AADI	read DO response !AA00000
@AADLB	Read the beginning of the period setting of the data logger for period logging mode response !AAyyyymmddhhmmss,

Command	Description
@AADLByyyymmddhhmmss	Set the beginning of the period setting of the data logger for period logging mode yyyy: year, 2000 to 2199, mm: month, 01 to 12, dd: date, 01 to 31, hh: hour, 0 to 24, mm: minute, 0 to 59, ss: second, 0 to 59
@AADLC	Read the data logger command response !AAh, 0: stop, 1: run, 2: run in period mode
@AADLCh	Set the data logger command, h->0: stop, 1: run, 2: run in period mode
@AADLE	Read the ending of the period setting of the data logger for period logging mode response !AAyyyymmddhhmmss
@AADLEyyyymmddhhmmss	Set the ending of the period setting of the data logger for period logging mode yyyy: year, 2000 to 2199, mm: month, 01 to 12, dd: date, 01 to 31, hh: hour, 0 to 24, mm: minute, 0 to 59, ss: second, 0 to 59
@AADLN	Read number of log records in the data logger response !AAhhhhhhhh, hhhhhhhh in hex format
@AADLO	Read the overwriting mode when data logger is full response !AAh, 0: stop logging when full, 1: overwrite
@AADLOh	Set the overwriting mode when data logger is full h->0: stop logging when full, 1: overwrite
@AADLP	Read the sampling period setting of the data logger response !AAhhmmss, hh: hour, 0 to 24, mm: minute, 0 to 59, ss: second, 0 to 59
@AADLPhmmss	Set the sampling period setting of the data logger
@AADLS	Read logging status of the data logger response !AAhh, hh in hex format, 00: stopped, 01: running, others: error
@AADO0V	set DO, V-> 0: off, 1: on

Command	Description
@AAEATCN	Enable AI alarm of a channel, N = 0 for TVOC, 1 for relative humidity, 2 for temperature in 0.01°C, 3 for temperature in 0.01°F, 4 for dew point temperature in 0.01°C, 5 for dew point temperature in 0.01°F T->M: momentary alarm, L: latched alarm
@AAFN	Read fan status Response !AAE, E=0: fan off, 1: fan on,
@AAFNE	Turn fan on or off E=0: fan off, 1: fan on
@AAFNPi	Read the ith fan off period in a day, i = 0 to 5 response !AAbhbmehem, bh: beginning hour, bm: beginning minute, eh: ending hour, em: ending minute.
@AAFNPibhbmehem	Set the ith fan off period in a day, i = 0 to 5, bh: beginning hour, 0 to 23, bm: beginning minute, 0 to 59, eh: ending hour, 0 to 23, em: ending minute, 0 to 59. The beginning hour/minute should be earlier than the ending hour/minute. Otherwise, the setting is ignored. If all of the six period settings are invalid, then the fan is controlled by the @AAFNE command.
@AAHI(data)CN	Set high alarm limit of an AI channel, N = 0 for TVOC in 1 ppb, 1 for relative humidity in 0.01%, 2 for temperature in 0.01°C, 3 for temperature in 0.01°F, 4 for dew point temperature in 0.01°C, 5 for dew point temperature in 0.01°F
@AAHO	Read humidity offset
@AAHO(data)	Set humidity offset, data in format of -100.00 ~ +100.00
@AALO(data)CN	Set low alarm limit of an AI channel, N = 1 for relative humidity in 0.01%, 2 for temperature in 0.01°C, 3 for temperature in 0.01°F, 4 for dew point temperature in 0.01°C, 5 for dew point temperature in 0.01°F
@AARACN	Read AI alarm enabled/disabled status of a channel response !AAN, N->0: disabled, 1: momentary, 2: latched
@AARAO	Read AI alarm status response !AAHLL

Command	Description
@AARH	Read all high latched values of analog input channels
@AARHN	Read channel high latched value of analog input
@AARHCN	Read high alarm limit of an AI channel
@AARL	Read all low latched values of analog input channels
@AARLN	Read channel low latched value of analog input
@AARLCN	Read low alarm limit of an AI channel
@AART	Read RTC data response !AAYYYYMMDDHHMMSS
@AARTYYYYMMDDHHMMSS	Set RTC data
@AAVO	Read TVOC offset
@AAVO(data)	Set TVOC offset, data in format of -00100. ~ +00100.
@AATO	Read temperature offset in 0.01°C
@AATO(data)	Set temperature offset in 0.01°C, -100.00 ~ +100.00
~**	clear host watchdog timeout counter
~AA0	read host watchdog status
~AA1	clear host watchdog timeout status
~AA2	read host watchdog enable/disable status and timeout value
~AA3ETT	enable/disable host watchdog and set timeout value E-> 0: disable host watchdog, 1: enable host watchdog TT: host watchdog timeout in 0.1s in hex format
~AA4	read DO power on and safe value
~AA50P0S	set DO power on and safe value P-> 0: power on value off, 1: power on value on S-> 0: safe value off, 1: safe value on
~AARD	read response delay time in ms in hex format
~AARDVV	set response delay time in ms, VV in hex format, 00 - 1E

A-9. CL-210-E DCON Command Sets

Command	Description
\$AAF	read firmware version
\$AAI	read INIT status response: !AA0 -> INIT short to GND !AA1 -> else
\$AAM	read module name
\$AAP	Read Modbus RTU/DCON protocol response: !AA0 -> DCON !AA1 -> Modbus RTU
\$AAPN	Set Modbus RTU/DCON protocol N-> 0: DCON, 1: Modbus RTU
\$AA2	read configuration
\$AA5	read reset status !AA1 first after power on, !AA0 others
#AA	Read All Analog Inputs response > (PM2.5 in 1 ug/m ³) (relative humidity in 0.01%)(temperature in 0.01°C)(temperature in 0.01°F) (dew point temperature in 0.01°C)(dew point temperature in 0.01°F)
#AAN	Read Channel Analog Input N = 0 for PM2.5 in 1 ug/m ³ , 1 for relative humidity in 0.01%, 2 for temperature in 0.01°C, 3 for temperature in 0.01°F, 4 for dew point temperature in 0.01°C, 5 for dew point temperature in 0.01°F
%AANNTTCCFF	set configuration, NN: new address, TT = 00, CC: new baud rate FF: data format
@AABA	Read beep on alarm time response !AAHH, HH in hex, 0: disabled, 1 ~ 250: beep on alarm time in seconds, 251: beep on alarm continuously
@AABAHH	Set beep on alarm time HH in hex, 0: disabled, 1 ~ 250: beep on alarm time in seconds, 251: beep on alarm continuously

Command	Description
@AABE	Read enable/disable beep on alarm response !AAHH, HH in hex, bit 0 for channel 0, bit 1 for channel 1, etc, for each bit, 0: disabled, 1: enabled
@AABEHH	Enable/disable beep on alarm HH in hex, , bit 0 for channel 0, bit 1 for channel 1, etc, for each bit, 0: disabled, 1: enabled
@AACH	Clear all high latched analog inputs to the current values
@AACHN	Clear channel high latched analog input to the current value, N = 0 for PM2.5, 1 for relative humidity, 2 for temperature in 0.01°C, 3 for temperature in 0.01°F, 4 for dew point temperature in 0.01°C, 5 for dew point temperature in 0.01°F
@AACHCN	Clear high latched alarm of a channel, N = 0 for PM2.5, 1 for relative humidity, 2 for temperature in 0.01°C, 3 for temperature in 0.01°F, 4 for dew point temperature in 0.01°C, 5 for dew point temperature in 0.01°F
@AACL	Clear all low latched analog inputs to the current values
@AACLN	Clear channel low latched analog input to the current value, N = 0 for PM2.5, 1 for relative humidity, 2 for temperature in 0.01°C, 3 for temperature in 0.01°F, 4 for dew point temperature in 0.01°C, 5 for dew point temperature in 0.01°F
@AACL CN	Clear low latched alarm of a channel, N = 1 for relative humidity, 2 for temperature in 0.01°C, 3 for temperature in 0.01°F, 4 for dew point temperature in 0.01°C, 5 for dew point temperature in 0.01°F
@AADACN	Disable AI alarm of a channel, N = 0 for PM2.5, 1 for relative humidity, 2 for temperature in 0.01°C, 3 for temperature in 0.01°F, 4 for dew point temperature in 0.01°C, 5 for dew point temperature in 0.01°F
@AADI	read DO response !AA00000
@AADLB	Read the beginning of the period setting of the data logger for period logging mode response !AAyyyymmddhhmmss,

Command	Description
@AADLByyyymmddhhmmss	Set the beginning of the period setting of the data logger for period logging mode yyyy: year, 2000 to 2199, mm: month, 01 to 12, dd: date, 01 to 31, hh: hour, 0 to 24, mm: minute, 0 to 59, ss: second, 0 to 59
@AADLC	Read the data logger command response !AAh, 0: stop, 1: run, 2: run in period mode
@AADLCh	Set the data logger command, h->0: stop, 1: run, 2: run in period mode
@AADLE	Read the ending of the period setting of the data logger for period logging mode response !AAyyyymmddhhmmss
@AADLEyyyymmddhhmmss	Set the ending of the period setting of the data logger for period logging mode yyyy: year, 2000 to 2199, mm: month, 01 to 12, dd: date, 01 to 31, hh: hour, 0 to 24, mm: minute, 0 to 59, ss: second, 0 to 59
@AADLN	Read number of log records in the data logger response !AAhhhhhhhh, hhhhhhhh in hex format
@AADLO	Read the overwriting mode when data logger is full response !AAh, 0: stop logging when full, 1: overwrite
@AADLOh	Set the overwriting mode when data logger is full h->0: stop logging when full, 1: overwrite
@AADLP	Read the sampling period setting of the data logger response !AAhhmmss, hh: hour, 0 to 24, mm: minute, 0 to 59, ss: second, 0 to 59
@AADLPhmmss	Set the sampling period setting of the data logger
@AADLS	Read logging status of the data logger response !AAhh, hh in hex format, 00: stopped, 01: running, others: error
@AADO0V	set DO, V-> 0: off, 1: on

Command	Description
@AAEATCN	Enable AI alarm of a channel, N = 0 for PM2.5, 1 for relative humidity, 2 for temperature in 0.01°C, 3 for temperature in 0.01°F, 4 for dew point temperature in 0.01°C, 5 for dew point temperature in 0.01°F T->M: momentary alarm, L: latched alarm
@AAFN	Read fan status Response !AAE, E=0: fan off, 1: fan on,
@AAFNE	Turn fan on or off E=0: fan off, 1: fan on
@AAFNPi	Read the ith fan off period in a day, i = 0 to 5 response !AAbhbmehem, bh: beginning hour, bm: beginning minute, eh: ending hour, em: ending minute.
@AAFNPibhbmehem	Set the ith fan off period in a day, i = 0 to 5, bh: beginning hour, 0 to 23, bm: beginning minute, 0 to 59, eh: ending hour, 0 to 23, em: ending minute, 0 to 59. The beginning hour/minute should be earlier than the ending hour/minute. Otherwise, the setting is ignored. If all of the six period settings are invalid, then the fan is controlled by the @AAFNE command.
@AAHI(data)CN	Set high alarm limit of an AI channel, N = 0 for PM2.5 in 1 ug/m ³ , 1 for relative humidity in 0.01%, 2 for temperature in 0.01°C, 3 for temperature in 0.01°F, 4 for dew point temperature in 0.01°C, 5 for dew point temperature in 0.01°F
@AAHO	Read humidity offset
@AAHO(data)	Set humidity offset, data in format of -100.00 ~ +100.00
@AALO(data)CN	Set low alarm limit of an AI channel, N = 1 for relative humidity in 0.01%, 2 for temperature in 0.01°C, 3 for temperature in 0.01°F, 4 for dew point temperature in 0.01°C, 5 for dew point temperature in 0.01°F
@AAPO	Read PM2.5 offset
@AAPO(data)	Set PM2.5 offset, data in format of -00100. ~ +00100.
@AARACN	Read AI alarm enabled/disabled status of a channel response !AAN, N->0: disabled, 1: momentary, 2: latched

Command	Description
@AARAO	Read AI alarm status response !AAHLL
@AARH	Read all high latched values of analog input channels
@AARHN	Read channel high latched value of analog input
@AARHCN	Read high alarm limit of an AI channel
@AARL	Read all low latched values of analog input channels
@AARLN	Read channel low latched value of analog input
@AARLCN	Read low alarm limit of an AI channel
@AART	Read RTC data response !AAYYYMMDDHHMMSS
@AARTYYYYMMDDHHMMSS	Set RTC data
@AATO	Read temperature offset in 0.01°C
@AATO(data)	Set temperature offset in 0.01°C, -100.00 ~ +100.00
~**	clear host watchdog timeout counter
~AA0	read host watchdog status
~AA1	clear host watchdog timeout status
~AA2	read host watchdog enable/disable status and timeout value
~AA3ETT	enable/disable host watchdog and set timeout value E-> 0: disable host watchdog, 1: enable host watchdog TT: host watchdog timeout in 0.1s in hex format
~AA4	read DO power on and safe value
~AA50P0S	set DO power on and safe value P-> 0: power on value off, 1: power on value on S-> 0: safe value off, 1: safe value on
~AARD	read response delay time in ms in hex format
~AARDVV	set response delay time in ms, VV in hex format, 00 - 1E

A-10. CL-211 / CL-211-E DCON Command Sets

Command	Description
\$AAF	Reads firmware version, AA is the RS-485 address (hex).
\$AAI	Reads INIT status, AA is the RS-485 address (hex). response: !AA0 -> INIT short to GND !AA1 -> else
\$AAM	Reads module name, AA is the RS-485 address (hex).
\$AAP	Reads Modbus RTU/DCON protocol. response: !AA0 -> DCON !AA1 -> Modbus RTU
\$AAPN	Sets Modbus RTU/DCON protocol N-> 0: DCON, 1: Modbus RTU
\$AA2	Reads configuration, AA is the RS-485 address (hex).
\$AA5	Reads reset status response !AA1 first after power on, !AA0 others
#AA	Read All Analog Inputs response >(CO in 1 ppm)(PM2.5 in 1 ug/m3)(relative humidity in 0.01%)(temperature in 0.01°C)(temperature in 0.01°F) (dew point temperature in 0.01°C)(dew point temperature in 0.01°F)
#AAN	Reads Channel Analog Input N = 0 for CO In 1ppm, 1 for PM2.5 in 1 ug/m3, 2 for relative humidity in 0.01%, 3 for temperature in 0.01°C, 4 for temperature in 0.01°F, 5 for dew point temperature in 0.01°C, 6 for dew point temperature in 0.01°F

Command	Description																				
%AANNTTCCFF	<p>Sets configuration,</p> <p>AA: current address</p> <p>NN: new address,</p> <p>TT = 00,</p> <p>CC: new baud rate</p> <p>Bits 5:0</p> <p>Baud rate, 0x03 ~ 0x0A</p> <table border="1"> <tbody> <tr> <td>Code</td> <td>0x03</td> <td>0x04</td> <td>0x05</td> <td>0x06</td> </tr> <tr> <td>Baud</td> <td>1200</td> <td>2400</td> <td>4800</td> <td>9600</td> </tr> <tr> <td>Code</td> <td>0x07</td> <td>0x08</td> <td>0x09</td> <td>0x0A</td> </tr> <tr> <td>Baud</td> <td>19200</td> <td>38400</td> <td>57600</td> <td>115200</td> </tr> </tbody> </table> <p>Bits 7:6</p> <p>00: no parity, 1 stop bit (N,8,1)</p> <p>01: no parity, 2 stop bits (N,8,2)</p> <p>10: even parity, 1 stop bit (E,8,1)</p> <p>11: odd parity, 1 stop bit (O,8,1)</p> <p>FF: data format</p> <p>Bit 6</p> <p>0: checksum disabled</p> <p>1: checksum enabled</p>	Code	0x03	0x04	0x05	0x06	Baud	1200	2400	4800	9600	Code	0x07	0x08	0x09	0x0A	Baud	19200	38400	57600	115200
Code	0x03	0x04	0x05	0x06																	
Baud	1200	2400	4800	9600																	
Code	0x07	0x08	0x09	0x0A																	
Baud	19200	38400	57600	115200																	
@AABA	<p>Read beep on alarm time response</p> <p>!AAHH, HH in hex, 0: disabled, 1 ~ 250: beep on alarm time in seconds, 251: beep on alarm continuously</p>																				
@AABAHH	<p>Set beep on alarm, HH in hex,</p> <p>0: disabled,</p> <p>1 ~ 250: beep on alarm time in seconds,</p> <p>251: beep on alarm continuously</p>																				
@AABE	<p>Read enable/disable beep on alarm Response</p> <p>!AAHH, HH in hex, bit 0 for channel 0, bit 1 for channel 1, etc, for each bit, 0: disabled, 1: enabled</p>																				

Command	Description
@ABEHH	Enable/disable beep on alarm HH in hex, , bit 0 for channel 0, bit 1 for channel 1, etc, for each bit, 0: disabled, 1: enabled
@AACH	Clear all high latched analog inputs to the current values
@AACHN	Clear channel high latched analog input to the current value N = 0 for CO In 1ppm, 1 for PM2.5 in 1 ug/m3, 2 for relative humidity in 0.01%, 3 for temperature in 0.01°C, 4 for temperature in 0.01°F, 5 for dew point temperature in 0.01°C, 6 for dew point temperature in 0.01°F
@AACHCN	Clear high latched alarm of a channel, N = 0 for CO In 1ppm, 1 for PM2.5 in 1 ug/m3, 2 for relative humidity in 0.01%, 3 for temperature in 0.01°C, 4 for temperature in 0.01°F, 5 for dew point temperature in 0.01°C, 6 for dew point temperature in 0.01°F
@AACL	Clear all low latched analog inputs to the current values
@AACLN	Clear channel low latched analog input to the current value N = 0 for CO In 1ppm, 1 for PM2.5 in 1 ug/m3, 2 for relative humidity in 0.01%, 3 for temperature in 0.01°C, 4 for temperature in 0.01°F, 5 for dew point temperature in 0.01°C, 6 for dew point temperature in 0.01°F
@AACL CN	Clear low latched alarm of a channel, N = 2 for relative humidity, 3 for temperature in 0.01°C, 4 for temperature in 0.01°F, 5 for dew point temperature in 0.01°C, 6 for dew point temperature in 0.01°F

Command	Description
@AADACN	Disable AI alarm of a channel, N = 0 for CO In 1ppm, 1 for PM2.5 in 1 ug/m3, 2 for relative humidity in 0.01%, 3 for temperature in 0.01°C, 4 for temperature in 0.01°F, 5 for dew point temperature in 0.01°C, 6 for dew point temperature in 0.01°F
@AAADI	read DO response !AA00000
@AADLB	Read the beginning of the period setting of the data logger for period logging mode response !AAyyyymmddhhmmss,
@AADLByyyyymmddhhmmss	Set the beginning of the period setting of the data logger for period logging mode yyyy: year, 2000 to 2199, mm: month, 01 to 12, dd: date, 01 to 31, hh: hour, 0 to 24, mm: minute, 0 to 59, ss: second, 0 to 59
@AADLC	Read the data logger command response !AAh, 0: stop, 1: run, 2: run in period mode
@AADLCh	Set the data logger command, h->0: stop, 1: run, 2: run in period mode
@AADLE	Read the ending of the period setting of the data logger for period logging mode response !AAyyyymmddhhmmss
@AADLEyyyymmddhhmmss	Set the ending of the period setting of the data logger for period logging mode yyyy: year, 2000 to 2199, mm: month, 01 to 12, dd: date, 01 to 31, hh: hour, 0 to 24, mm: minute, 0 to 59, ss: second, 0 to 59
@AADLN	Read number of log records in the data logger response !AAhhhhhhhh, hhhhhhhh in hex format

Command	Description
@AADLO	Read the overwriting mode when data logger is full response !AAh, 0: stop logging when full, 1: overwrite
@AADLOh	Set the overwriting mode when data logger is full h->0: stop logging when full, 1: overwrite
@AADLP	Read the sampling period setting of the data logger response !AAhmmss, hh: hour, 0 to 24, mm: minute, 0 to 59, ss: second, 0 to 59
@AADLPhmmss	Set the sampling period setting of the data logger
@AADLS	Read logging status of the data logger response !AAhh, hh in hex format, 00: stopped, 01: running, others: error
@AADO0V	set DO, V-> 0: off, 1: on
@AAEATCN	Enable AI alarm of a channel, N = 0 for CO In 1ppm, 1 for PM2.5 in 1 ug/m3, 2 for relative humidity in 0.01%, 3 for temperature in 0.01℃, 4 for temperature in 0.01℉, 5 for dew point temperature in 0.01℃, 6 for dew point temperature in 0.01℉ T->M: momentary alarm mode, L: latched alarm mode
@AAFN	Read fan status Response !AAE, E=0: fan off, 1: fan on,
@AAFNE	Turn fan on or off E=0: fan off, 1: fan on
@AAFNPi	Read the i-th fan off period in a day, i = 0 to 5 response !AAhbmehem, bh: beginning hour, bm: beginning minute, eh: ending hour, em: ending minute.

Command	Description
@AAFNPibhbmeh em	Set the i-th fan off period in a day, i = 0 to 5, bh: beginning hour, 0 to 23, bm: beginning minute, 0 to 59, eh: ending hour, 0 to 23, em: ending minute, 0 to 59. The beginning hour/minute should be earlier than the ending hour/minute. Otherwise, the setting is ignored. If all of the six period settings are invalid, then the fan is controlled by the @AAFNE command.
@AAHI(data)CN	Set high alarm limit of an AI channel, N = 0 for CO In 1ppm, 1 for PM2.5 in 1 ug/m3, 2 for relative humidity in 0.01%, 3 for temperature in 0.01°C, 4 for temperature in 0.01°F, 5 for dew point temperature in 0.01°C, 6 for dew point temperature in 0.01°F
@AAHO	Read humidity offset
@AAHO(data)	Set humidity offset, data in format of -100.00 ~ +100.00
@AALO(data)CN	Set low alarm limit of an AI channel, N = 1 for relative humidity in 0.01%, 2 for temperature in 0.01°C, 3 for temperature in 0.01°F, 4 for dew point temperature in 0.01°C, 5 for dew point temperature in 0.01°F
@AAPO	Read PM2.5 offset
@AAPO(data)	Set PM2.5 offset, data in format of -00100. ~ +00100.
@AARACN	Read AI alarm enabled/disabled status of a channel response !AAN, N->0: disabled, 1: momentary, 2: latched
@AARAO	Read AI alarm status response !AAHLL
@AARH	Read all high latched values of analog input channels response >(CO in 1 ppm)(relative humidity in 0.01%)(temperature in 0.01°C)(temperature in 0.01°F)(dew point temperature in 0.01°C)(dew point temperature in 0.01°F)

Command	Description
@AARHN	Read channel high latched value of analog input N = 0 for CO In 1ppm, 1 for PM2.5 in 1 ug/m3, 2 for relative humidity in 0.01%, 3 for temperature in 0.01°C, 4 for temperature in 0.01°F, 5 for dew point temperature in 0.01°C, 6 for dew point temperature in 0.01°F
@AARHCN	Read high alarm limit of an AI channel N = 0 for CO In 1ppm, 1 for PM2.5 in 1 ug/m3, 2 for relative humidity in 0.01%, 3 for temperature in 0.01°C, 4 for temperature in 0.01°F, 5 for dew point temperature in 0.01°C, 6 for dew point temperature in 0.01°F
@AARL	Read all low latched values of analog input channels response >(CO in 1 ppm)(relative humidity in 0.01%)(temperature in 0.01°C)(temperature in 0.01°F)(dew point temperature in 0.01°C)(dew point temperature in 0.01°F)
@AARLN	Read channel low latched value of analog input N = 0 for CO In 1ppm, 1 for PM2.5 in 1 ug/m3, 2 for relative humidity in 0.01%, 3 for temperature in 0.01°C, 4 for temperature in 0.01°F, 5 for dew point temperature in 0.01°C, 6 for dew point temperature in 0.01°F
@AARLCN	Read low alarm limit of an AI channel N = 1 for relative humidity in 0.01%, 2 for temperature in 0.01°C, 3 for temperature in 0.01°F, 4 for dew point temperature in 0.01°C, 5 for dew point temperature in 0.01°F

Command	Description
@AART	Read RTC data response !AAYYYMMDDHHMMSS
@AARTYYMMDD HHMMSS	Set RTC data
@AATO	Read temperature offset in 0.01°C
@AATO(data)	Set temperature offset in 0.01°C, -100.00 ~ +100.00
~**	clear host watchdog timeout counter
~AA0	read host watchdog status
~AA1	clear host watchdog timeout status
~AA2	read host watchdog enable/disable status and timeout value
~AA3ETT	enable/disable host watchdog and set timeout value E-> 0: disable host watchdog, 1: enable host watchdog TT: host watchdog timeout in 0.1s in hex format
~AA4	read DO power on and safe value
~AA50P0S	set DO power on and safe value P-> 0: power on value off, 1: power on value on S-> 0: safe value off, 1: safe value on
~AARD	read response delay time in ms in hex format
~AARDVV	set response delay time in ms, VV in hex format, 00 - 1E

A-11. CL-212 / CL-212-E DCON Command Sets

Command	Description
\$AAF	Reads firmware version, AA is the RS-485 address (hex).
\$AAI	Reads INIT status, AA is the RS-485 address (hex). response: !AA0 -> INIT short to GND !AA1 -> else
\$AAM	Reads module name, AA is the RS-485 address (hex).
\$AAP	Reads Modbus RTU/DCON protocol. response: !AA0 -> DCON !AA1 -> Modbus RTU
\$AAPN	Sets Modbus RTU/DCON protocol N-> 0: DCON, 1: Modbus RTU
\$AA2	Reads configuration, AA is the RS-485 address (hex).
\$AA5	Reads reset status response !AA1 first after power on, !AA0 others
#AA	Read All Analog Inputs response >(CO ₂ in 1 ppm)(PM2.5 in 1 ug/m ³)(relative humidity in 0.01%)(temperature in 0.01°C)(temperature in 0.01°F) (dew point temperature in 0.01°C)(dew point temperature in 0.01°F)
#AAN	Reads Channel Analog Input N = 0 for CO ₂ In 1ppm, 1 for PM2.5 in 1 ug/m ³ , 2 for relative humidity in 0.01%, 3 for temperature in 0.01°C, 4 for temperature in 0.01°F, 5 for dew point temperature in 0.01°C, 6 for dew point temperature in 0.01°F

Command	Description																				
%AANNTTCCFF	<p>Sets configuration,</p> <p>AA: current address</p> <p>NN: new address,</p> <p>TT = 00,</p> <p>CC: new baud rate</p> <p>Bits 5:0</p> <p>Baud rate, 0x03 ~ 0x0A</p> <table border="1"> <tbody> <tr> <td>Code</td> <td>0x03</td> <td>0x04</td> <td>0x05</td> <td>0x06</td> </tr> <tr> <td>Baud</td> <td>1200</td> <td>2400</td> <td>4800</td> <td>9600</td> </tr> <tr> <td>Code</td> <td>0x07</td> <td>0x08</td> <td>0x09</td> <td>0x0A</td> </tr> <tr> <td>Baud</td> <td>19200</td> <td>38400</td> <td>57600</td> <td>115200</td> </tr> </tbody> </table> <p>Bits 7:6</p> <p>00: no parity, 1 stop bit (N,8,1)</p> <p>01: no parity, 2 stop bits (N,8,2)</p> <p>10: even parity, 1 stop bit (E,8,1)</p> <p>11: odd parity, 1 stop bit (O,8,1)</p> <p>FF: data format</p> <p>Bit 6</p> <p>0: checksum disabled</p> <p>1: checksum enabled</p>	Code	0x03	0x04	0x05	0x06	Baud	1200	2400	4800	9600	Code	0x07	0x08	0x09	0x0A	Baud	19200	38400	57600	115200
Code	0x03	0x04	0x05	0x06																	
Baud	1200	2400	4800	9600																	
Code	0x07	0x08	0x09	0x0A																	
Baud	19200	38400	57600	115200																	
@AAABC	<p>Read status of the automatic baseline correction</p> <p>Response</p> <p>!AAN, N=0: disabled, 1: enabled</p>																				
@AAABCN	<p>Set the automatic baseline correction</p> <p>N->0: disabled, 1:enabled</p>																				
@AABA	<p>Read beep on alarm time</p> <p>response</p> <p>!AAHH, HH in hex, 0: disabled, 1 ~ 250: beep on alarm time in seconds, 251: beep on alarm continuously</p>																				
@AABAHH	<p>Set beep on alarm, HH in hex,</p> <p>0: disabled,</p> <p>1 ~ 250: beep on alarm time in seconds,</p> <p>251: beep on alarm continuously</p>																				

Command	Description
@AABE	Read enable/disable beep on alarm Response !AAHH, HH in hex, bit 0 for channel 0, bit 1 for channel 1, etc, for each bit, 0: disabled, 1: enabled
@AABEHH	Enable/disable beep on alarm HH in hex, , bit 0 for channel 0, bit 1 for channel 1, etc, for each bit, 0: disabled, 1: enabled
@AACH	Clear all high latched analog inputs to the current values
@AACHN	Clear channel high latched analog input to the current value N = 0 for CO ₂ In 1ppm, 1 for PM2.5 in 1 ug/m3, 2 for relative humidity in 0.01%, 3 for temperature in 0.01°C, 4 for temperature in 0.01°F, 5 for dew point temperature in 0.01°C, 6 for dew point temperature in 0.01°F
@AACHCN	Clear high latched alarm of a channel, N = 0 for CO ₂ In 1ppm, 1 for PM2.5 in 1 ug/m3, 2 for relative humidity in 0.01%, 3 for temperature in 0.01°C, 4 for temperature in 0.01°F, 5 for dew point temperature in 0.01°C, 6 for dew point temperature in 0.01°F
@AACL	Clear all low latched analog inputs to the current values
@AACLN	Clear channel low latched analog input to the current value N = 0 for CO ₂ In 1ppm, 1 for PM2.5 in 1 ug/m3, 2 for relative humidity in 0.01%, 3 for temperature in 0.01°C, 4 for temperature in 0.01°F, 5 for dew point temperature in 0.01°C, 6 for dew point temperature in 0.01°F

Command	Description
@AACLCN	Clear low latched alarm of a channel, N = 2 for relative humidity, 3 for temperature in 0.01°C, 4 for temperature in 0.01°F, 5 for dew point temperature in 0.01°C, 6 for dew point temperature in 0.01°F
@AADACN	Disable AI alarm of a channel, N = 0 for CO ₂ In 1ppm, 1 for PM2.5 in 1 ug/m3, 2 for relative humidity in 0.01%, 3 for temperature in 0.01°C, 4 for temperature in 0.01°F, 5 for dew point temperature in 0.01°C, 6 for dew point temperature in 0.01°F
@AADI	read DO response !AA00000
@AADLB	Read the beginning of the period setting of the data logger for period logging mode response !AAyyyymmddhhmmss,
@AADLByyyymmddhhmmss	Set the beginning of the period setting of the data logger for period logging mode yyyy: year, 2000 to 2199, mm: month, 01 to 12, dd: date, 01 to 31, hh: hour, 0 to 24, mm: minute, 0 to 59, ss: second, 0 to 59
@AADLC	Read the data logger command response !AAh, 0: stop, 1: run, 2: run in period mode
@AADLCh	Set the data logger command, h->0: stop, 1: run, 2: run in period mode
@AADLE	Read the ending of the period setting of the data logger for period logging mode response !AAyyyymmddhhmmss

Command	Description
@AADLEyyyymmddhmmss	Set the ending of the period setting of the data logger for period logging mode yyyy: year, 2000 to 2199, mm: month, 01 to 12, dd: date, 01 to 31, hh: hour, 0 to 24, mm: minute, 0 to 59, ss: second, 0 to 59
@AADLN	Read number of log records in the data logger response !AAhhhhhhhh, hhhhhhhh in hex format
@AADLO	Read the overwriting mode when data logger is full response !AAh, 0: stop logging when full, 1: overwrite
@AADLOh	Set the overwriting mode when data logger is full h->0: stop logging when full, 1: overwrite
@AADLP	Read the sampling period setting of the data logger response !AAhmmss, hh: hour, 0 to 24, mm: minute, 0 to 59, ss: second, 0 to 59
@AADLPhmmss	Set the sampling period setting of the data logger
@AADLS	Read logging status of the data logger response !AAhh, hh in hex format, 00: stopped, 01: running, others: error
@AADO0V	set DO, V-> 0: off, 1: on
@AAEATCN	Enable AI alarm of a channel, N = 0 for CO ₂ In 1ppm, 1 for PM2.5 in 1 ug/m3, 2 for relative humidity in 0.01%, 3 for temperature in 0.01°C, 4 for temperature in 0.01°F, 5 for dew point temperature in 0.01°C, 6 for dew point temperature in 0.01°F T->M: momentary alarm mode, L: latched alarm mode
@AAFN	Read fan status Response !AAE, E=0: fan off, 1: fan on,
@AAFNE	Turn fan on or off E=0: fan off, 1: fan on

Command	Description
@AAFNPi	Read the i-th fan off period in a day, i = 0 to 5 response !AAbhbmehem, bh: beginning hour, bm: beginning minute, eh: ending hour, em: ending minute.
@AAFNPibhbmeh em	Set the i-th fan off period in a day, i = 0 to 5, bh: beginning hour, 0 to 23, bm: beginning minute, 0 to 59, eh: ending hour, 0 to 23, em: ending minute, 0 to 59. The beginning hour/minute should be earlier than the ending hour/minute. Otherwise, the setting is ignored. If all of the six period settings are invalid, then the fan is controlled by the @AAFNE command.
@AAHI(data)CN	Set high alarm limit of an AI channel, N = 0 for CO ₂ In 1ppm, 1 for PM2.5 in 1 ug/m3, 2 for relative humidity in 0.01%, 3 for temperature in 0.01°C, 4 for temperature in 0.01°F, 5 for dew point temperature in 0.01°C, 6 for dew point temperature in 0.01°F
@AAHO	Read humidity offset
@AAHO(data)	Set humidity offset, data in format of -100.00 ~ +100.00
@AALO(data)CN	Set low alarm limit of an AI channel, N = 1 for relative humidity in 0.01%, 2 for temperature in 0.01°C, 3 for temperature in 0.01°F, 4 for dew point temperature in 0.01°C, 5 for dew point temperature in 0.01°F
@AAPO	Read PM2.5 offset
@AAPO(data)	Set PM2.5 offset, data in format of -00100. ~ +00100.
@AARACN	Read AI alarm enabled/disabled status of a channel response !AAN, N->0: disabled, 1: momentary, 2: latched
@AARAO	Read AI alarm status response !AAHLL

Command	Description
@AARH	Read all high latched values of analog input channels response >(CO ₂ in 1 ppm)(relative humidity in 0.01%)(temperature in 0.01°C)(temperature in 0.01°F)(dew point temperature in 0.01°C)(dew point temperature in 0.01°F)
@AARHN	Read channel high latched value of analog input N = 0 for CO ₂ In 1ppm, 1 for PM2.5 in 1 ug/m3, 2 for relative humidity in 0.01%, 3 for temperature in 0.01°C, 4 for temperature in 0.01°F, 5 for dew point temperature in 0.01°C, 6 for dew point temperature in 0.01°F
@AARHCN	Read high alarm limit of an AI channel N = 0 for CO ₂ In 1ppm, 1 for PM2.5 in 1 ug/m3, 2 for relative humidity in 0.01%, 3 for temperature in 0.01°C, 4 for temperature in 0.01°F, 5 for dew point temperature in 0.01°C, 6 for dew point temperature in 0.01°F
@AARL	Read all low latched values of analog input channels response >(CO ₂ in 1 ppm)(relative humidity in 0.01%)(temperature in 0.01°C)(temperature in 0.01°F)(dew point temperature in 0.01°C)(dew point temperature in 0.01°F)
@AARLN	Read channel low latched value of analog input N = 0 for CO ₂ In 1ppm, 1 for PM2.5 in 1 ug/m3, 2 for relative humidity in 0.01%, 3 for temperature in 0.01°C, 4 for temperature in 0.01°F, 5 for dew point temperature in 0.01°C, 6 for dew point temperature in 0.01°F

Command	Description
@AARLCN	Read low alarm limit of an AI channel N = 1 for relative humidity in 0.01%, 2 for temperature in 0.01°C, 3 for temperature in 0.01°F, 4 for dew point temperature in 0.01°C, 5 for dew point temperature in 0.01°F
@AART	Read RTC data response !AAYYYMMDDHHMMSS
@AARTYYMMDD HHMMSS	Set RTC data
@AATO	Read temperature offset in 0.01°C
@AATO(data)	Set temperature offset in 0.01°C, -100.00 ~ +100.00
~**	clear host watchdog timeout counter
~AA0	read host watchdog status
~AA1	clear host watchdog timeout status
~AA2	read host watchdog enable/disable status and timeout value
~AA3ETT	enable/disable host watchdog and set timeout value E-> 0: disable host watchdog, 1: enable host watchdog TT: host watchdog timeout in 0.1s in hex format
~AA4	read DO power on and safe value
~AA50POS	set DO power on and safe value P-> 0: power on value off, 1: power on value on S-> 0: safe value off, 1: safe value on
~AARD	read response delay time in ms in hex format
~AARDVV	set response delay time in ms, VV in hex format, 00 - 1E

A-12. CL-213 / CL-213-E DCON Command Sets

Command	Description
\$AAF	Reads firmware version, AA is the RS-485 address (hex).
\$AAI	Reads INIT status, AA is the RS-485 address (hex). response: !AA0 -> INIT short to GND !AA1 -> else
\$AAM	Reads module name, AA is the RS-485 address (hex).
\$AAP	Reads Modbus RTU/DCON protocol. response: !AA0 -> DCON !AA1 -> Modbus RTU
\$AAPN	Sets Modbus RTU/DCON protocol N-> 0: DCON, 1: Modbus RTU
\$AA2	Reads configuration, AA is the RS-485 address (hex).
\$AA5	Reads reset status response !AA1 first after power on, !AA0 others
#AA	Read All Analog Inputs response >(CO in 1 ppm) (CO ₂ in 1 ppm)(PM2.5 in 1 ug/m3)(relative humidity in 0.01%)(temperature in 0.01°C)(temperature in 0.01°F) (dew point temperature in 0.01°C)(dew point temperature in 0.01°F)
#AAN	Reads Channel Analog Input N = 0 for CO In 1ppm, 1 for CO ₂ In 1ppm, 2 for PM2.5 in 1 ug/m3, 3 for relative humidity in 0.01%, 4 for temperature in 0.01°C, 5 for temperature in 0.01°F, 6 for dew point temperature in 0.01°C, 7 for dew point temperature in 0.01°F

Command	Description																				
%AANNTTCCFF	<p>Sets configuration,</p> <p>AA: current address</p> <p>NN: new address,</p> <p>TT = 00,</p> <p>CC: new baud rate</p> <p>Bits 5:0</p> <p>Baud rate, 0x03 ~ 0x0A</p> <table border="1"> <tbody> <tr> <td>Code</td> <td>0x03</td> <td>0x04</td> <td>0x05</td> <td>0x06</td> </tr> <tr> <td>Baud</td> <td>1200</td> <td>2400</td> <td>4800</td> <td>9600</td> </tr> <tr> <td>Code</td> <td>0x07</td> <td>0x08</td> <td>0x09</td> <td>0x0A</td> </tr> <tr> <td>Baud</td> <td>19200</td> <td>38400</td> <td>57600</td> <td>115200</td> </tr> </tbody> </table> <p>Bits 7:6</p> <p>00: no parity, 1 stop bit (N,8,1)</p> <p>01: no parity, 2 stop bits (N,8,2)</p> <p>10: even parity, 1 stop bit (E,8,1)</p> <p>11: odd parity, 1 stop bit (O,8,1)</p> <p>FF: data format</p> <p>Bit 6</p> <p>0: checksum disabled</p> <p>1: checksum enabled</p>	Code	0x03	0x04	0x05	0x06	Baud	1200	2400	4800	9600	Code	0x07	0x08	0x09	0x0A	Baud	19200	38400	57600	115200
Code	0x03	0x04	0x05	0x06																	
Baud	1200	2400	4800	9600																	
Code	0x07	0x08	0x09	0x0A																	
Baud	19200	38400	57600	115200																	
@AAABC	<p>Read status of the automatic baseline correction</p> <p>Response</p> <p>!AAN, N=0: disabled, 1: enabled</p>																				
@AAABCN	<p>Set the automatic baseline correction</p> <p>N->0: disabled, 1:enabled</p>																				
@AABA	<p>Read beep on alarm time</p> <p>response</p> <p>!AAHH, HH in hex, 0: disabled, 1 ~ 250: beep on alarm time in seconds, 251: beep on alarm continuously</p>																				
@AABAHH	<p>Set beep on alarm, HH in hex,</p> <p>0: disabled,</p> <p>1 ~ 250: beep on alarm time in seconds,</p> <p>251: beep on alarm continuously</p>																				

Command	Description
@AABE	Read enable/disable beep on alarm Response !AAHH, HH in hex, bit 0 for channel 0, bit 1 for channel 1, etc, for each bit, 0: disabled, 1: enabled
@AABEHH	Enable/disable beep on alarm HH in hex, , bit 0 for channel 0, bit 1 for channel 1, etc, for each bit, 0: disabled, 1: enabled
@AACH	Clear all high latched analog inputs to the current values
@AACHN	Clear channel high latched analog input to the current value N = 0 for CO In 1ppm, 1 for CO ₂ In 1ppm, 2 for PM2.5 in 1 ug/m3, 3 for relative humidity in 0.01%, 4 for temperature in 0.01°C, 5 for temperature in 0.01°F, 6 for dew point temperature in 0.01°C, 7 for dew point temperature in 0.01°F
@AACHCN	Clear high latched alarm of a channel, N = 0 for CO In 1ppm, 1 for CO ₂ In 1ppm, 2 for PM2.5 in 1 ug/m3, 3 for relative humidity in 0.01%, 4 for temperature in 0.01°C, 5 for temperature in 0.01°F, 6 for dew point temperature in 0.01°C, 7 for dew point temperature in 0.01°F
@AACL	Clear all low latched analog inputs to the current values
@AACLN	Clear channel low latched analog input to the current value N = 0 for CO In 1ppm, 1 for CO ₂ In 1ppm, 2 for PM2.5 in 1 ug/m3, 3 for relative humidity in 0.01%, 4 for temperature in 0.01°C, 5 for temperature in 0.01°F, 6 for dew point temperature in 0.01°C, 7 for dew point temperature in 0.01°F

Command	Description
@AACLCN	Clear low latched alarm of a channel, N = 3 for relative humidity, 4 for temperature in 0.01°C, 5 for temperature in 0.01°F, 6 for dew point temperature in 0.01°C, 7 for dew point temperature in 0.01°F
@AADACN	Disable AI alarm of a channel, N = 0 for CO In 1ppm, 1 for CO ₂ In 1ppm, 2 for PM2.5 in 1 ug/m3, 3 for relative humidity in 0.01%, 4 for temperature in 0.01°C, 5 for temperature in 0.01°F, 6 for dew point temperature in 0.01°C, 7 for dew point temperature in 0.01°F
@AADI	read DO response !AA00000
@AADLB	Read the beginning of the period setting of the data logger for period logging mode response !AAyyyymmddhhmmss,
@AADLByyyymmddhhmmss	Set the beginning of the period setting of the data logger for period logging mode yyyy: year, 2000 to 2199, mm: month, 01 to 12, dd: date, 01 to 31, hh: hour, 0 to 24, mm: minute, 0 to 59, ss: second, 0 to 59
@AADLC	Read the data logger command response !AAh, 0: stop, 1: run, 2: run in period mode
@AADLCh	Set the data logger command, h->0: stop, 1: run, 2: run in period mode
@AADLE	Read the ending of the period setting of the data logger for period logging mode response !AAyyyymmddhhmmss

Command	Description
@AADLEyyyymmdd dhmmss	Set the ending of the period setting of the data logger for period logging mode yyyy: year, 2000 to 2199, mm: month, 01 to 12, dd: date, 01 to 31, hh: hour, 0 to 24, mm: minute, 0 to 59, ss: second, 0 to 59
@AADLN	Read number of log records in the data logger response !AAhhhhhhhh, hhhhhhhh in hex format
@AADLO	Read the overwriting mode when data logger is full response !AAh, 0: stop logging when full, 1: overwrite
@AADLOh	Set the overwriting mode when data logger is full h->0: stop logging when full, 1: overwrite
@AADLP	Read the sampling period setting of the data logger response !AAhhmmss, hh: hour, 0 to 24, mm: minute, 0 to 59, ss: second, 0 to 59
@AADLPhmmss	Set the sampling period setting of the data logger
@AADLS	Read logging status of the data logger response !AAhh, hh in hex format, 00: stopped, 01: running, others: error
@AADO0V	set DO, V-> 0: off, 1: on
@AAEATCN	Enable AI alarm of a channel, N = 0 for CO In 1ppm, 1 for CO ₂ In 1ppm, 2 for PM2.5 in 1 ug/m3, 3 for relative humidity in 0.01%, 4 for temperature in 0.01°C, 5 for temperature in 0.01°F, 6 for dew point temperature in 0.01°C, 7 for dew point temperature in 0.01°F T->M: momentary alarm mode, L: latched alarm mode
@AAFN	Read fan status Response !AAE, E=0: fan off, 1: fan on,
@AAFNE	Turn fan on or off E=0: fan off, 1: fan on

Command	Description
@AAFNPi	Read the i-th fan off period in a day, i = 0 to 5 response !AAbhbmehem, bh: beginning hour, bm: beginning minute, eh: ending hour, em: ending minute.
@AAFNPibhbmeh em	Set the i-th fan off period in a day, i = 0 to 5, bh: beginning hour, 0 to 23, bm: beginning minute, 0 to 59, eh: ending hour, 0 to 23, em: ending minute, 0 to 59. The beginning hour/minute should be earlier than the ending hour/minute. Otherwise, the setting is ignored. If all of the six period settings are invalid, then the fan is controlled by the @AAFNE command.
@AAHI(data)CN	Set high alarm limit of an AI channel, N = 0 for CO In 1ppm, 1 for CO ₂ In 1ppm, 2 for PM2.5 in 1 ug/m3, 3 for relative humidity in 0.01%, 4 for temperature in 0.01°C, 5 for temperature in 0.01°F, 6 for dew point temperature in 0.01°C, 7 for dew point temperature in 0.01°F
@AAHO	Read humidity offset
@AAHO(data)	Set humidity offset, data in format of -100.00 ~ +100.00
@AALO(data)CN	Set low alarm limit of an AI channel, N = 3 for relative humidity in 0.01%, 4 for temperature in 0.01°C, 5 for temperature in 0.01°F, 6 for dew point temperature in 0.01°C, 7 for dew point temperature in 0.01°F
@AAPO	Read PM2.5 offset
@AAPO(data)	Set PM2.5 offset, data in format of -00100. ~ +00100.
@AARACN	Read AI alarm enabled/disabled status of a channel response !AAN, N->0: disabled, 1: momentary, 2: latched
@AARAO	Read AI alarm status response !AAHLL

Command	Description
@AARH	Read all high latched values of analog input channels response >(CO in 1 ppm) (CO ₂ in 1 ppm)(relative humidity in 0.01%)(temperature in 0.01°C)(temperature in 0.01°F)(dew point temperature in 0.01°C)(dew point temperature in 0.01°F)
@AARHN	Read channel high latched value of analog input N = 0 for CO In 1ppm, 1 for CO ₂ In 1ppm, 2 for PM2.5 in 1 ug/m3, 3 for relative humidity in 0.01%, 4 for temperature in 0.01°C, 5 for temperature in 0.01°F, 6 for dew point temperature in 0.01°C, 7 for dew point temperature in 0.01°F
@AARHCN	Read high alarm limit of an AI channel N = 0 for CO In 1ppm, 1 for CO ₂ In 1ppm, 2 for PM2.5 in 1 ug/m3, 3 for relative humidity in 0.01%, 4 for temperature in 0.01°C, 5 for temperature in 0.01°F, 6 for dew point temperature in 0.01°C, 7 for dew point temperature in 0.01°F
@AARL	Read all low latched values of analog input channels response >(CO in 1 ppm) (CO ₂ in 1 ppm)(relative humidity in 0.01%)(temperature in 0.01°C)(temperature in 0.01°F)(dew point temperature in 0.01°C)(dew point temperature in 0.01°F)
@AARLN	Read channel low latched value of analog input N = 0 for CO In 1ppm, 1 for CO ₂ In 1ppm, 2 for PM2.5 in 1 ug/m3, 3 for relative humidity in 0.01%, 4 for temperature in 0.01°C, 5 for temperature in 0.01°F, 6 for dew point temperature in 0.01°C, 7 for dew point temperature in 0.01°F

Command	Description
@AARLCN	Read low alarm limit of an AI channel N = 3 for relative humidity in 0.01%, 4 for temperature in 0.01°C, 5 for temperature in 0.01°F, 6 for dew point temperature in 0.01°C, 7 for dew point temperature in 0.01°F
@AART	Read RTC data response !AAYYYMMDDHHMMSS
@AARTYYMMDD HHMMSS	Set RTC data
@AATO	Read temperature offset in 0.01°C
@AATO(data)	Set temperature offset in 0.01°C, -100.00 ~ +100.00
~**	clear host watchdog timeout counter
~AA0	read host watchdog status
~AA1	clear host watchdog timeout status
~AA2	read host watchdog enable/disable status and timeout value
~AA3ETT	enable/disable host watchdog and set timeout value E-> 0: disable host watchdog, 1: enable host watchdog TT: host watchdog timeout in 0.1s in hex format
~AA4	read DO power on and safe value
~AA50POS	set DO power on and safe value P-> 0: power on value off, 1: power on value on S-> 0: safe value off, 1: safe value on
~AARD	read response delay time in ms in hex format
~AARDVV	set response delay time in ms, VV in hex format, 00 - 1E

A-13. CL-250-E DCON Command Sets

Command	Description
\$AAF	read firmware version
\$AAI	read INIT status response: !AA0 -> INIT short to GND !AA1 -> else
\$AAM	read module name
\$AAP	Read Modbus RTU/DCON protocol response: !AA0 -> DCON !AA1 -> Modbus RTU
\$AAPN	Set Modbus RTU/DCON protocol N-> 0: DCON, 1: Modbus RTU
\$AA2	read configuration
\$AA5	read reset status !AA1 first after power on, !AA0 others
#AA	Read All Analog Inputs response > (O ₂ in 0.01%) (relative humidity in 0.01%)(temperature in 0.01°C)(temperature in 0.01°F) (dew point temperature in 0.01°C)(dew point temperature in 0.01°F)
#AAN	Read Channel Analog Input N = 0 for O ₂ in 0.01%, 1 for relative humidity in 0.01%, 2 for temperature in 0.01°C, 3 for temperature in 0.01°F, 4 for dew point temperature in 0.01°C, 5 for dew point temperature in 0.01°F
%AANNTTCCFF	set configuration, NN: new address, TT = 00, CC: new baud rate FF: data format
@AABA	Read beep on alarm time response !AAHH, HH in hex, 0: disabled, 1 ~ 250: beep on alarm time in seconds, 251: beep on alarm continuously
@AABAHH	Set beep on alarm time HH in hex, 0: disabled, 1 ~ 250: beep on alarm time in seconds, 251: beep on alarm continuously

Command	Description
@AABE	Read enable/disable beep on alarm response !AAHH, HH in hex, bit 0 for channel 0, bit 1 for channel 1, etc, for each bit, 0: disabled, 1: enabled
@AABEHH	Enable/disable beep on alarm HH in hex, , bit 0 for channel 0, bit 1 for channel 1, etc, for each bit, 0: disabled, 1: enabled
@AACH	Clear all high latched analog inputs to the current values
@AACHN	Clear channel high latched analog input to the current value, N = 0 for O ₂ , 1 for relative humidity, 2 for temperature in 0.01°C, 3 for temperature in 0.01°F, 4 for dew point temperature in 0.01°C, 5 for dew point temperature in 0.01°F
@AACHCN	Clear high latched alarm of a channel, N = 1 for relative humidity, 2 for temperature in 0.01°C, 3 for temperature in 0.01°F, 4 for dew point temperature in 0.01°C, 5 for dew point temperature in 0.01°F
@AACL	Clear all low latched analog inputs to the current values
@AACLN	Clear channel low latched analog input to the current value, N = 0 for O ₂ , 1 for relative humidity, 2 for temperature in 0.01°C, 3 for temperature in 0.01°F, 4 for dew point temperature in 0.01°C, 5 for dew point temperature in 0.01°F
@AACL CN	Clear low latched alarm of a channel, N = 0 for O ₂ , 1 for relative humidity, 2 for temperature in 0.01°C, 3 for temperature in 0.01°F, 4 for dew point temperature in 0.01°C, 5 for dew point temperature in 0.01°F
@AADACN	Disable AI alarm of a channel, N = 0 for O ₂ , 1 for relative humidity, 2 for temperature in 0.01°C, 3 for temperature in 0.01°F, 4 for dew point temperature in 0.01°C, 5 for dew point temperature in 0.01°F
@AADI	read DO response !AA00000
@AADLB	Read the beginning of the period setting of the data logger for period logging mode response !AAyyyymmddhhmmss,

Command	Description
@AADLByyyymmddhhmmss	Set the beginning of the period setting of the data logger for period logging mode yyyy: year, 2000 to 2199, mm: month, 01 to 12, dd: date, 01 to 31, hh: hour, 0 to 24, mm: minute, 0 to 59, ss: second, 0 to 59
@AADLC	Read the data logger command response !AAh, 0: stop, 1: run, 2: run in period mode
@AADLCh	Set the data logger command, h->0: stop, 1: run, 2: run in period mode
@AADLE	Read the ending of the period setting of the data logger for period logging mode response !AAyyyymmddhhmmss
@AADLEyyyymmddhhmmss	Set the ending of the period setting of the data logger for period logging mode yyyy: year, 2000 to 2199, mm: month, 01 to 12, dd: date, 01 to 31, hh: hour, 0 to 24, mm: minute, 0 to 59, ss: second, 0 to 59
@AADLN	Read number of log records in the data logger response !AAhhhhhhhh, hhhhhhhh in hex format
@AADLO	Read the overwriting mode when data logger is full response !AAh, 0: stop logging when full, 1: overwrite
@AADLOh	Set the overwriting mode when data logger is full h->0: stop logging when full, 1: overwrite
@AADLP	Read the sampling period setting of the data logger response !AAhhmmss, hh: hour, 0 to 24, mm: minute, 0 to 59, ss: second, 0 to 59
@AADLPhmmss	Set the sampling period setting of the data logger
@AADLS	Read logging status of the data logger response !AAhh, hh in hex format, 00: stopped, 01: running, others: error
@AADO0V	set DO, V-> 0: off, 1: on

Command	Description
@AAEATCN	Enable AI alarm of a channel, N = 0 for O ₂ , 1 for relative humidity, 2 for temperature in 0.01°C, 3 for temperature in 0.01°F, 4 for dew point temperature in 0.01°C, 5 for dew point temperature in 0.01°F T->M: momentary alarm, L: latched alarm
@AAHI(data)CN	Set high alarm limit of an AI channel, N = 1 for relative humidity in 0.01%, 2 for temperature in 0.01°C, 3 for temperature in 0.01°F, 4 for dew point temperature in 0.01°C, 5 for dew point temperature in 0.01°F
@AAHO	Read humidity offset
@AAHO(data)	Set humidity offset, data in format of -100.00 ~ +100.00
@AALO(data)CN	Set low alarm limit of an AI channel, N = 0 for O ₂ in 0.01%, 1 for relative humidity in 0.01%, 2 for temperature in 0.01°C, 3 for temperature in 0.01°F, 4 for dew point temperature in 0.01°C, 5 for dew point temperature in 0.01°F
@AARACN	Read AI alarm enabled/disabled status of a channel response !AAN, N->0: disabled, 1: momentary, 2: latched
@AARAO	Read AI alarm status response !AAHLL
@AARH	Read all high latched values of analog input channels
@AARHN	Read channel high latched value of analog input
@AARHCN	Read high alarm limit of an AI channel
@AARL	Read all low latched values of analog input channels
@AARLN	Read channel low latched value of analog input
@AARLCN	Read low alarm limit of an AI channel
@AART	Read RTC data response !AAYYYMMDDHHMMSS
@AARTYYYYMMDDHHMMSS	Set RTC data
@AATO	Read temperature offset in 0.01°C
@AATO(data)	Set temperature offset in 0.01°C, -100.00 ~ +100.00
~**	clear host watchdog timeout counter
~AA0	read host watchdog status
~AA1	clear host watchdog timeout status

Command	Description
~AA2	read host watchdog enable/disable status and timeout value
~AA3ETT	enable/disable host watchdog and set timeout value E-> 0: disable host watchdog, 1: enable host watchdog TT: host watchdog timeout in 0.1s in hex format
~AA4	read DO power on and safe value
~AA50P0S	set DO power on and safe value P-> 0: power on value off, 1: power on value on S-> 0: safe value off, 1: safe value on
~AARD	read response delay time in ms in hex format
~AARDVV	set response delay time in ms, VV in hex format, 00 - 1E

Baud Rate Setting (CC)

Bits 5:0

Baud rate, 0x03 ~ 0x0A

Code	0x03	0x04	0x05	0x06
Baud	1200	2400	4800	9600
Code	0x07	0x08	0x09	0x0A
Baud	19200	38400	57600	115200

Bits 7:6

00: no parity, 1 stop bit

01: no parity, 2 stop bits

10: even parity, 1 stop bit

11: odd parity, 1 stop bit

Data Format Setting (FF)

Bit 6

0: checksum disabled

1: checksum enabled

Base Address: 192 (0xC0)

DIP Switch	
1	Off: Modbus RTU, On: DCON
2	Off: hardware configuration, On: software configuration
3	On: rotary switch address added by 16
4	On: INIT

Appendix B: ModbusMasterToolPC

ModbusMasterToolPC is a free, easy-to-use tool for Modbus communication and diagnosing the wiring. It is located in the company CD:

CD:\Napdos\IIOT\utility\ and needless to install

<http://ftp.icpdas.com/pub/cd/usbcd/napdos/iiot/utility/modbusmastertoolpc/>

This section intends to guide the steps for creating the Modbus communication with CL-200 logger.

1. Launch the ModbusMasterToolPC.exe.
2. Select **New** in the File menu.

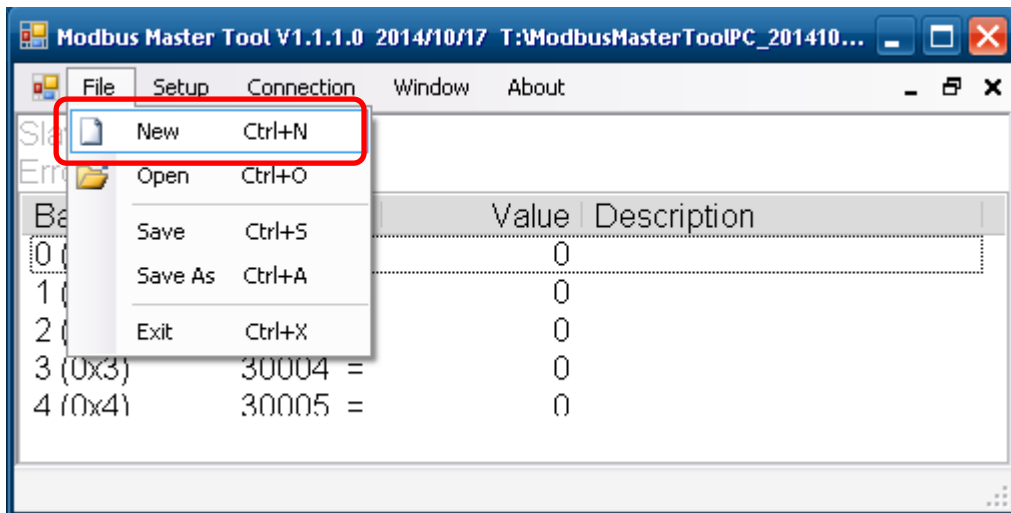

3. Input the file name and click on the **Save** button.

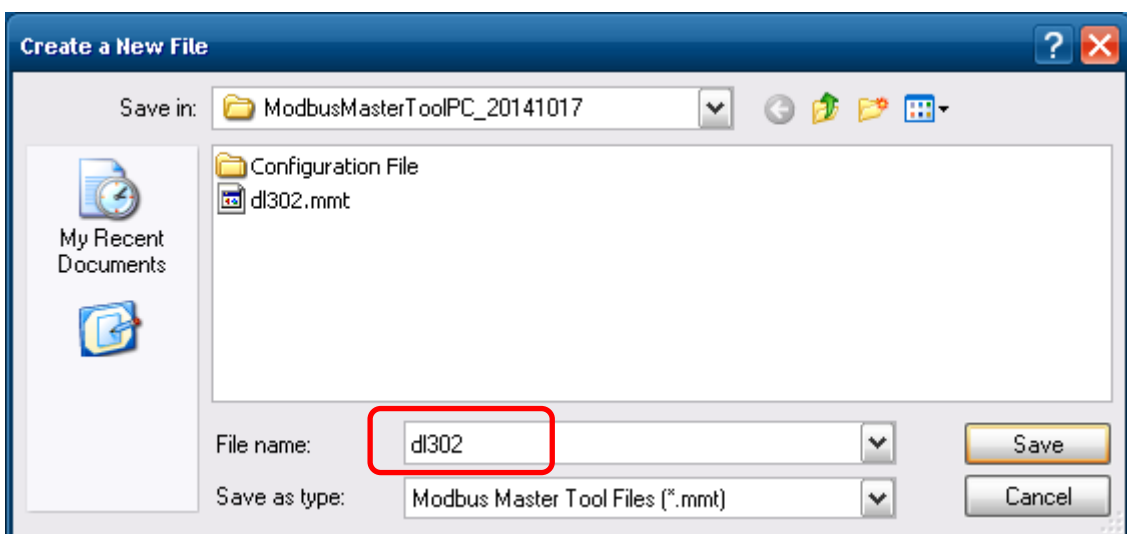

4. Select **Connect** in the *Connection* menu.

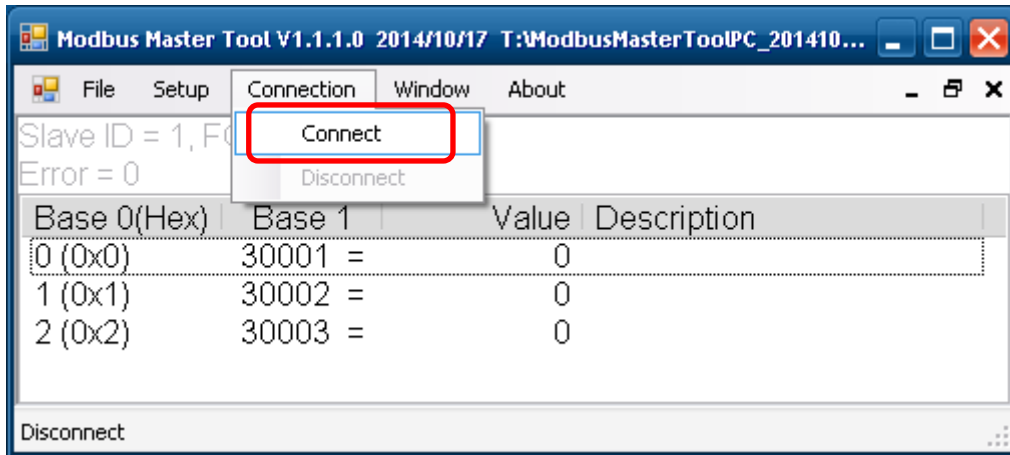

5. Select the communication interface. When using **TCP/IP** as the interface, input the IP for your logger and click on the **OK** button.

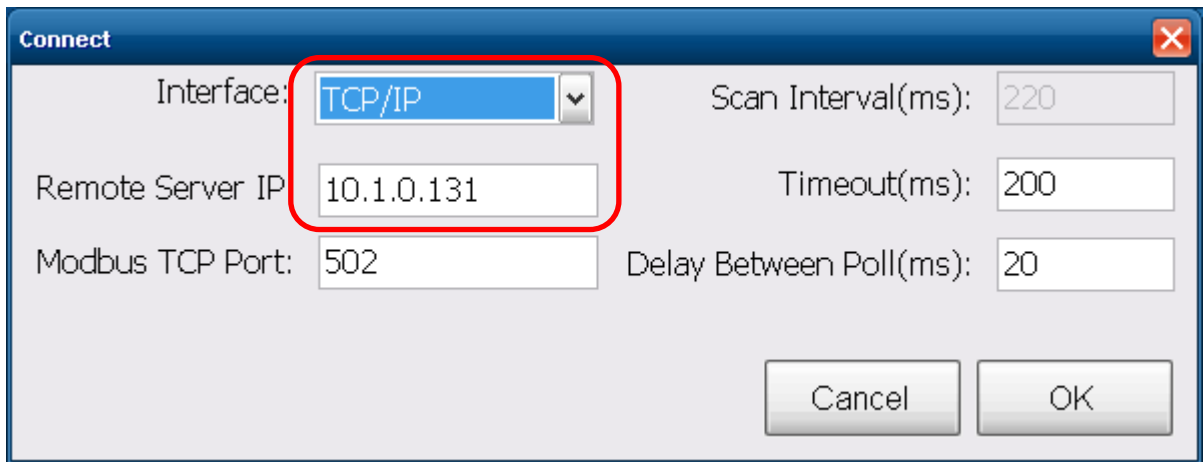

When using RS-485 as the interface, select the COM port, check the RTU mode and click on the **OK** button.

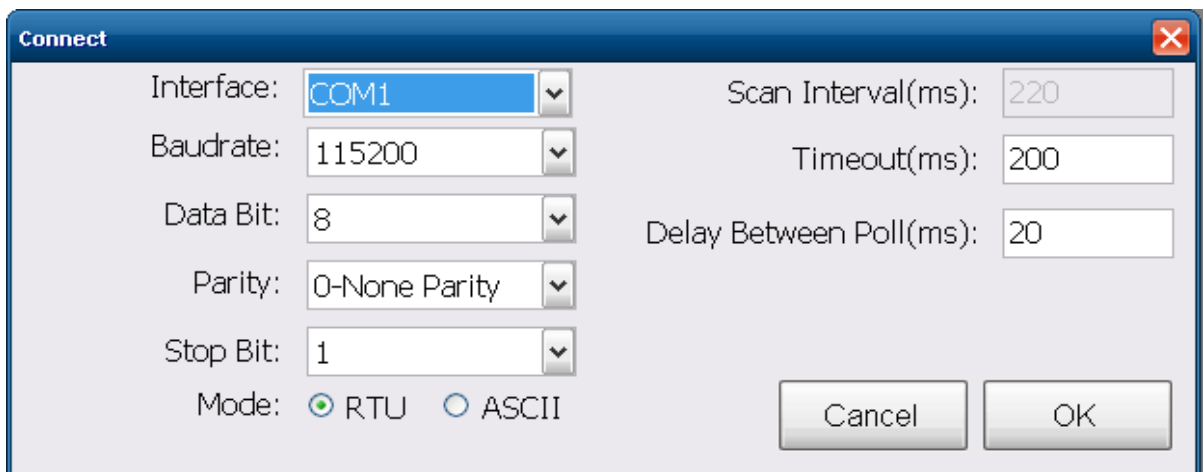

6. Select **Definition** in the Setup menu.

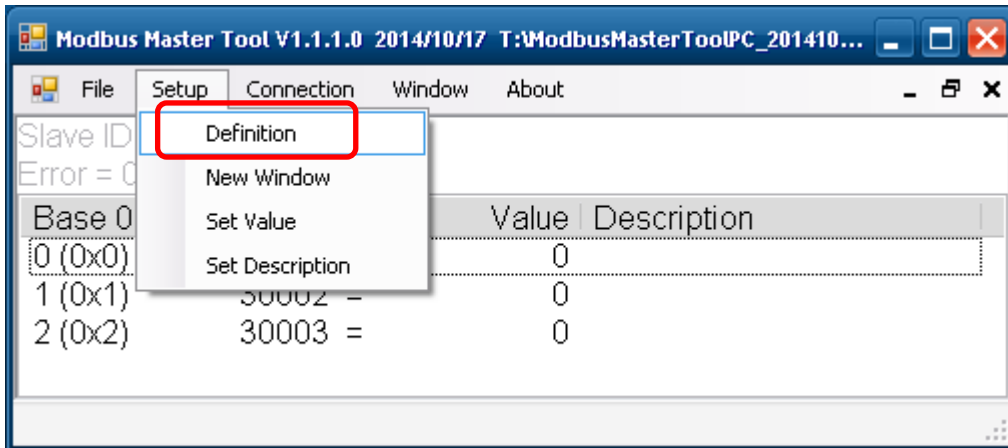

7. Select the Modbus function code, input the start address and length, and click on the **OK** button.

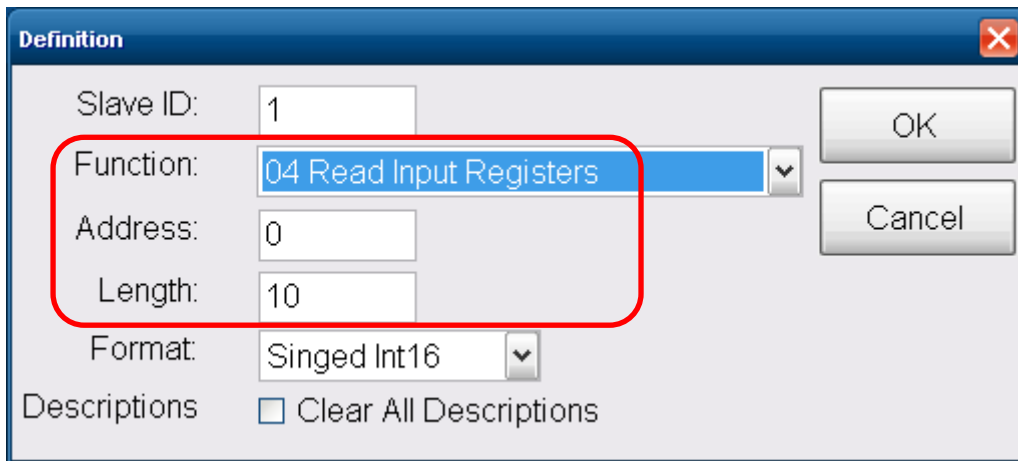

8. Read data.

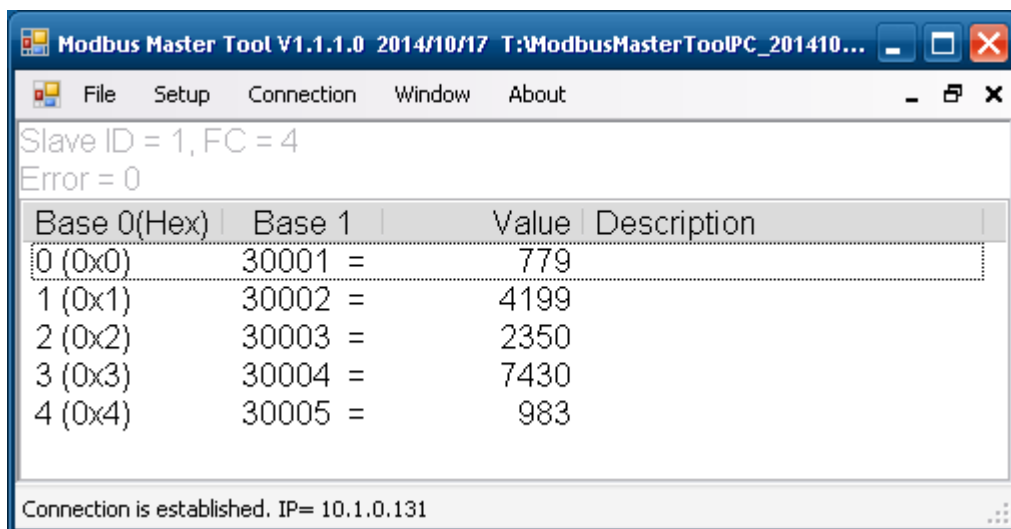

9. Write data to Holding Register or Coil Status

1. Highlight the Modbus address in the Holding Register or Coil Status list
2. Select **Set Value** in the *Setup* menu.
3. Input the data in the Value box and click on the **OK** button

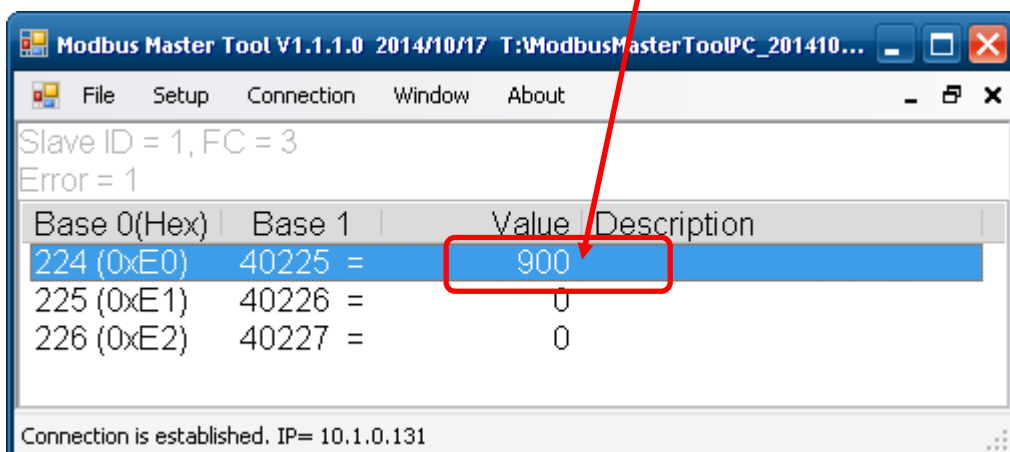
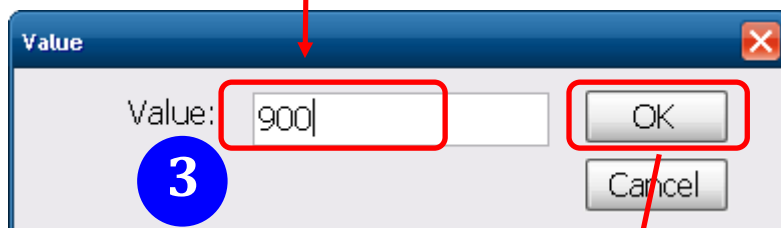
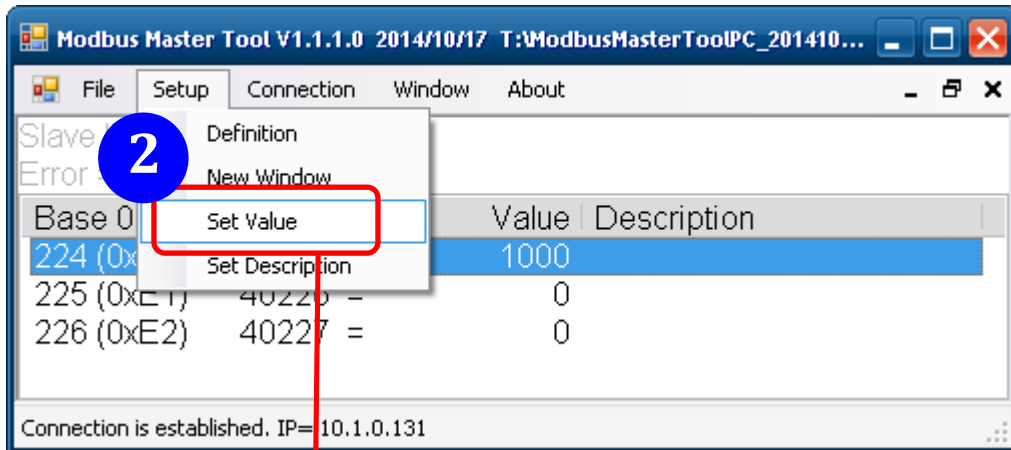

Appendix C: Modbus Address Table

C-1. CL-201-E Modbus Address Mappings (Base 1)

Address	Description	Attribute
30001 ~ 30006 40001 ~ 40006	Analog input value of channel 0 to 5. channel 0: CO in 1ppm, channel 1: relative humidity in 0.01%, channel 2: temperature in 0.01°C, channel 3:temperature in 0.01°F, channel 4: dew point temperature in 0.01°C, channel 5: dew point temperature in 0.01°F	R
40225 ~ 40230	High alarm limit of channel 0 to 5, channel 0: CO in 1ppm, channel 1: relative humidity in 0.01%, channel 2: temperature in 0.01°C, channel 3:temperature in 0.01°F, channel 4: dew point temperature in 0.01°C, channel 5: dew point temperature in 0.01°F	R/W
40234 ~ 40238	Low alarm limit of channel 1 to 5, channel 1: relative humidity in 0.01%, channel 2: temperature in 0.01°C, channel 3: temperature in 0.01°F, channel 4: dew point temperature in 0.01 °C, channel 5: dew point temperature in 0.01°F	R/W
40272	Modbus NetID Only for Modbus TCP protocol	R/W
30301 40301	Number of the digital input channels Only for Modbus TCP protocol	R
30311 40311	Number of the digital output channels Only for Modbus TCP protocol	R
30321 40321	Number of the analog input channels Only for Modbus TCP protocol	R
30331 40331	Number of the analog output channels Only for Modbus TCP protocol	R
30352 40352	Firmware version in hex format Only for Modbus TCP protocol	R
40449	CO offset in 1 ppm	R/W
40450	Relative humidity offset in 0.01%	R/W
40451	Temperature offset in 0.01°C	R/W
40481	Firmware version (low word)	R
40482	Firmware version (high word)	R
40483	Module name (low word), 0x0203	R
40484	Module name (high word), 0x434C	R

Address	Description	Attribute
40485	RS-485 module address, 1 to 247 Only for Modbus RTU protocol	R/W
40486	RS-485 baud rate and parity settings Bits 5:0 Baud rate, valid range: 3 ~ 10 Bits 7:6 00: no parity, 1 stop bit 01: no parity, 2 stop bit 10: even parity, 1 stop bit 11: odd parity , 1 stop bit Only for Modbus RTU protocol	R/W
40488	RS-485 response delay time in ms, valid range, 0 ~ 30 Only for Modbus RTU protocol	R/W
40489	RS-485 host watchdog timeout value, 0 ~ 255, in 0.1s Only for Modbus RTU protocol	R/W
40492	RS-485 host watchdog timeout count, write 0 to clear Only for Modbus RTU protocol	R/W
40497	Beep on alarm, 0: disable, 1 to 250: beep on alarm time in seconds, 251: beep on alarm continuously	R/W
30513 ~ 30518 40513 ~ 40518	High latched analog input value of channel 0 to 5	R
30545 ~ 30550 40545 ~ 40550	Low latched analog input value of channel 0 to 5	R
30556 40556	Module reset status, 1: power-on, 2: watchdog, 3: software reset command Only for Modbus TCP protocol	R
40558	Ethernet host watchdog timeout value, 5 to 65535, in second, 0 to disable. Only for Modbus TCP protocol	R/W
30559 40559	Ethernet host watchdog timeout count. Only for Modbus TCP protocol	R
30560 40560	Module name, 0x0203 Only for Modbus TCP protocol	R

Address	Description	Attribute
40564	TCP disconnection timeout value, 5 to 65535, in second, 0 to disable. Only for Modbus TCP protocol	R/W
40565	Module reset timeout value, 30 to 65535, in second, 0 to disable. Only for Modbus TCP protocol	R/W
40865	RTC year, 2000 to 2159	R/W
40866	RTC month, 1 to 12	R/W
40867	RTC date, 1 to 31	R/W
40868	RTC hour, 0 to 23	R/W
40869	RTC minute, 0 to 59	R/W
40870	RTC second, 0 to 59	R/W
40871	Total number of log records, low word	R
40872	Total number of log records, high word	R
40873	The starting record to read log data, low word	R/W
40874	The starting record to read log data, high word	R/W
40875	The status of the data logging, 0: stopped, 1: running	R
40876	The data logger command, 0: stop, 1: run, 2: run in period mode	R/W
40877	Continue writing when data logger is full, 0: no, 1: yes	R/W
40878	Hour of the data logger sampling period, 0 ~ 24	R/W
40879	Minute of the data logger sampling period, 0 ~ 59	R/W
40880	Second of the data logger sampling period, 0 ~ 59	R/W
40881	Starting year when logging in period mode, 2000 ~ 2159	R/W
40882	Starting month when logging in period mode, 1 ~ 12	R/W
40883	Starting date when logging in period mode, 1 ~ 31	R/W
40884	Starting hour when logging in period mode, 0 ~ 23	R/W
40885	Starting minute when logging in period mode, 0 ~ 59	R/W
40886	Starting second when logging in period mode, 0 ~ 59	R/W
40887	Ending year when logging in period mode, 2000 ~ 2159	R/W
40888	Ending month when logging in period mode, 1 ~ 12	R/W
40889	Ending date when logging in period mode, 1 ~ 31	R/W
40890	Ending hour when logging in period mode, 0 ~ 23	R/W
40891	Ending minute when logging in period mode, 0 ~ 59	R/W
40892	Ending second when logging in period mode, 0 ~ 59	R/W
00001	Digital output value of channel 0	R/W
00129	Safe value of digital output channel 0	R/W
00161	Power on value of digital output channel 0	R/W

Address	Description	Attribute
00227	Write 1 to reload default TCP settings Only for Modbus TCP protocol	W
00234	Write 1 to reboot module Only for Modbus TCP protocol	W
00257	RS-485 Protocol, 0: DCON, 1: Modbus RTU Only for Modbus RTU protocol	R/W
00260	Modbus RTU host watchdog mode 0: same as I-7000 1: can use AO and DO command to clear host watchdog timeout status Only for Modbus RTU protocol	R/W
00261	RS-485 host watchdog mode, 1: enable, 0: disable. Only for Modbus RTU protocol	R/W
00262	Write 1 to play notification sound	W
00270	Host watch dog timeout status, write 1 to clear host watch dog timeout status Only for Modbus RTU protocol	R/W
00273	Reset status, 1: first read after powered on, 0: not the first read after powered on Only for Modbus RTU protocol	R
00280	Write 1 to clear all high latched analog input values	W
00281	Write 1 to clear all low latched analog input values	W
00290 ~ 00294	Low alarm status of channel 1 to 5. Write 1 to clear low latched alarm.	R/W
00305 ~ 00310	High alarm status of channel 0 to 5. Write 1 to clear high latched alarm.	R/W
00321 ~ 00326	Enable/disable alarm of channel 0 to 5	R/W
00337 ~ 00342	Alarm type, momentary or latched, of channel 0 to 5	R/W
00385 ~ 00390	Write 1 to clear high latched analog input value of channel 0 to 5	W
00417 ~ 00422	Write 1 to clear low latched analog input value of channel 0 to 5	W
00449 ~ 00454	Enable/disable beep on alarm for channel 0 to 5	R/W

C-2. CL-202-E Modbus Address Mappings (Base 1)

Address	Description	Attribute
30001 ~ 30006 40001 ~ 40006	Analog input value of channel 0 to 5. channel 0: CO ₂ in 1ppm, channel 1: relative humidity in 0.01%, channel 2: temperature in 0.01°C, channel 3:temperature in 0.01°F, channel 4: dew point temperature in 0.01°C, channel 5: dew point temperature in 0.01°F	R
40225 ~ 40230	High alarm limit of channel 0 to 5, channel 0: CO ₂ in 1ppm, channel 1: relative humidity in 0.01%, channel 2: temperature in 0.01°C, channel 3:temperature in 0.01°F, channel 4: dew point temperature in 0.01°C, channel 5: dew point temperature in 0.01°F	R/W
40234 ~ 40238	Low alarm limit of channel 1 to 5, channel 1: relative humidity in 0.01%, channel 2: temperature in 0.01°C, channel 3: temperature in 0.01°F, channel 4: dew point temperature in 0.01 °C, channel 5: dew point temperature in 0.01°F	R/W
40272	Modbus NetID Only for Modbus TCP protocol	R/W
30301 40301	Number of the digital input channels Only for Modbus TCP protocol	R
30311 40311	Number of the digital output channels Only for Modbus TCP protocol	R
30321 40321	Number of the analog input channels Only for Modbus TCP protocol	R
30331 40331	Number of the analog output channels Only for Modbus TCP protocol	R
30352 40352	Firmware version in hex format Only for Modbus TCP protocol	R
40449	CO ₂ offset in 1 ppm	R/W
40450	Relative humidity offset in 0.01%	R/W
40451	Temperature offset in 0.01°C	R/W
40481	Firmware version (low word)	R
40482	Firmware version (high word)	R
40483	Module name (low word), 0x0203	R
40484	Module name (high word), 0x434C	R
40485	RS-485 module address, 1 to 247 Only for Modbus RTU protocol	R/W

Address	Description	Attribute
40486	RS-485 baud rate and parity settings Bits 5:0 Baud rate, valid range: 3 ~ 10 Bits 7:6 00: no parity, 1 stop bit 01: no parity, 2 stop bit 10: even parity, 1 stop bit 11: odd parity , 1 stop bit Only for Modbus RTU protocol	R/W
40488	RS-485 response delay time in ms, valid range, 0 ~ 30 Only for Modbus RTU protocol	R/W
40489	RS-485 host watchdog timeout value, 0 ~ 255, in 0.1s Only for Modbus RTU protocol	R/W
40492	RS-485 host watchdog timeout count, write 0 to clear Only for Modbus RTU protocol	R/W
40496	Automatic baseline correction for CO ₂ measurement, 0: disable, 1:enable	R/W
40497	Beep on alarm, 0: disable, 1 to 250: beep on alarm time in seconds, 251: beep on alarm continuously	R/W
30513 ~ 30518 40513 ~ 40518	High latched analog input value of channel 0 to 5	R
30545 ~ 30550 40545 ~ 40550	Low latched analog input value of channel 0 to 5	R
30556 40556	Module reset status, 1: power-on, 2: watchdog, 3: software reset command Only for Modbus TCP protocol	R
40558	Ethernet host watchdog timeout value, 5 to 65535, in second, 0 to disable. Only for Modbus TCP protocol	R/W
30559 40559	Ethernet host watchdog timeout count. Only for Modbus TCP protocol	R
30560 40560	Module name, 0x0203 Only for Modbus TCP protocol	R

Address	Description	Attribute
40564	TCP disconnection timeout value, 5 to 65535, in second, 0 to disable. Only for Modbus TCP protocol	R/W
40565	Module reset timeout value, 30 to 65535, in second, 0 to disable. Only for Modbus TCP protocol	R/W
40865	RTC year, 2000 to 2159	R/W
40866	RTC month, 1 to 12	R/W
40867	RTC date, 1 to 31	R/W
40868	RTC hour, 0 to 23	R/W
40869	RTC minute, 0 to 59	R/W
40870	RTC second, 0 to 59	R/W
40871	Total number of log records, low word	R
40872	Total number of log records, high word	R
40873	The starting record to read log data, low word	R/W
40874	The starting record to read log data, high word	R/W
40875	The status of the data logging, 0: stopped, 1: running	R
40876	The data logger command, 0: stop, 1: run, 2: run in period mode	R/W
40877	Continue writing when data logger is full, 0: no, 1: yes	R/W
40878	Hour of the data logger sampling period, 0 ~ 24	R/W
40879	Minute of the data logger sampling period, 0 ~ 59	R/W
40880	Second of the data logger sampling period, 0 ~ 59	R/W
40881	Starting year when logging in period mode, 2000 ~ 2159	R/W
40882	Starting month when logging in period mode, 1 ~ 12	R/W
40883	Starting date when logging in period mode, 1 ~ 31	R/W
40884	Starting hour when logging in period mode, 0 ~ 23	R/W
40885	Starting minute when logging in period mode, 0 ~ 59	R/W
40886	Starting second when logging in period mode, 0 ~ 59	R/W
40887	Ending year when logging in period mode, 2000 ~ 2159	R/W
40888	Ending month when logging in period mode, 1 ~ 12	R/W
40889	Ending date when logging in period mode, 1 ~ 31	R/W
40890	Ending hour when logging in period mode, 0 ~ 23	R/W
40891	Ending minute when logging in period mode, 0 ~ 59	R/W
40892	Ending second when logging in period mode, 0 ~ 59	R/W
00001	Digital output value of channel 0	R/W
00129	Safe value of digital output channel 0	R/W
00161	Power on value of digital output channel 0	R/W

Address	Description	Attribute
00227	Write 1 to reload default TCP settings Only for Modbus TCP protocol	W
00234	Write 1 to reboot module Only for Modbus TCP protocol	W
00257	RS-485 Protocol, 0: DCON, 1: Modbus RTU Only for Modbus RTU protocol	R/W
00260	Modbus RTU host watchdog mode 0: same as I-7000 1: can use AO and DO command to clear host watchdog timeout status Only for Modbus RTU protocol	R/W
00261	RS-485 host watchdog mode, 1: enable, 0: disable. Only for Modbus RTU protocol	R/W
00262	Write 1 to play notification sound	W
00270	Host watch dog timeout status, write 1 to clear host watch dog timeout status Only for Modbus RTU protocol	R/W
00273	Reset status, 1: first read after powered on, 0: not the first read after powered on Only for Modbus RTU protocol	R
00280	Write 1 to clear all high latched analog input values	W
00281	Write 1 to clear all low latched analog input values	W
00290 ~ 00294	Low alarm status of channel 1 to 5. Write 1 to clear low latched alarm.	R/W
00305 ~ 00310	High alarm status of channel 0 to 5. Write 1 to clear high latched alarm.	R/W
00321 ~ 00326	Enable/disable alarm of channel 0 to 5	R/W
00337 ~ 00342	Alarm type, momentary or latched, of channel 0 to 5	R/W
00385 ~ 00390	Write 1 to clear high latched analog input value of channel 0 to 5	W
00417 ~ 00422	Write 1 to clear low latched analog input value of channel 0 to 5	W
00449 ~ 00454	Enable/disable beep on alarm for channel 0 to 5	R/W

C-3. CL-203-E Modbus Address Mappings (Base 1)

Address	Description	Attribute
30001 ~ 30007 40001 ~ 40007	Analog input value of channel 0 to 6. channel 0: CO in 1ppm, channel 1: CO ₂ in 1ppm, channel 2: relative humidity in 0.01%, channel 3: temperature in 0.01°C, channel 4:tempera ture in 0.01°F, channel 5: dew point temperature in 0.01°C, channel 6: dew point temperature in 0.01°F	R
40225 ~ 40231	High alarm limit of channel 0 to 6, channel 0: CO in 1ppm, channel 1: CO ₂ in 1ppm, channel 2: relative humidity in 0.01%, channel 3: temperature in 0.01°C, channel 4:temperature in 0.0 1°F, channel 5: dew point temperature in 0.01°C, channel 6: dew point temperature in 0.01°F	R/W
40235 ~ 40239	Low alarm limit of channel 2 to 6, channel 2: relative humidity in 0.01%, channel 3: temperature in 0.01°C, channel 4: temperature in 0.01°F, channel 5: dew point temperature in 0.01 °C, channel 6: dew point temperature in 0.01°F	R/W
40272	Modbus NetID Only for Modbus TCP protocol	R/W
30301 40301	Number of the digital input channels Only for Modbus TCP protocol	R
30311 40311	Number of the digital output channels Only for Modbus TCP protocol	R
30321 40321	Number of the analog input channels Only for Modbus TCP protocol	R
30331 40331	Number of the analog output channels Only for Modbus TCP protocol	R
30352 40352	Firmware version in hex format Only for Modbus TCP protocol	R
40449	CO offset in 1 ppm	R/W
40450	CO ₂ offset in 1 ppm	R/W
40451	Relative humidity offset in 0.01%	R/W
40452	Temperature offset in 0.01°C	R/W
40481	Firmware version (low word)	R
40482	Firmware version (high word)	R
40483	Module name (low word), 0x0203	R
40484	Module name (high word), 0x434C	R
40485	RS-485 module address, 1 to 247 Only for Modbus RTU protocol	R/W

Address	Description	Attribute
40486	RS-485 baud rate and parity settings Bits 5:0 Baud rate, valid range: 3 ~ 10 Bits 7:6 00: no parity, 1 stop bit 01: no parity, 2 stop bit 10: even parity, 1 stop bit 11: odd parity , 1 stop bit Only for Modbus RTU protocol	R/W
40488	RS-485 response delay time in ms, valid range, 0 ~ 30 Only for Modbus RTU protocol	R/W
40489	RS-485 host watchdog timeout value, 0 ~ 255, in 0.1s Only for Modbus RTU protocol	R/W
40492	RS-485 host watchdog timeout count, write 0 to clear Only for Modbus RTU protocol	R/W
40496	Automatic baseline correction for CO ₂ measurement, 0: disable, 1:enable	R/W
40497	Beep on alarm, 0: disable, 1 to 250: beep on alarm time in seconds, 251: beep on alarm continuously	R/W
30513 ~ 30519 40513 ~ 40519	High latched analog input value of channel 0 to 6	R
30545 ~ 30551 40545 ~ 40551	Low latched analog input value of channel 0 to 6	R
30556 40556	Module reset status, 1: power-on, 2: watchdog, 3: software reset command Only for Modbus TCP protocol	R
40558	Ethernet host watchdog timeout value, 5 to 65535, in second, 0 to disable. Only for Modbus TCP protocol	R/W
30559 40559	Ethernet host watchdog timeout count. Only for Modbus TCP protocol	R
30560 40560	Module name, 0x0203 Only for Modbus TCP protocol	R

Address	Description	Attribute
40564	TCP disconnection timeout value, 5 to 65535, in second, 0 to disable. Only for Modbus TCP protocol	R/W
40565	Module reset timeout value, 30 to 65535, in second, 0 to disable. Only for Modbus TCP protocol	R/W
40865	RTC year, 2000 to 2159	R/W
40866	RTC month, 1 to 12	R/W
40867	RTC date, 1 to 31	R/W
40868	RTC hour, 0 to 23	R/W
40869	RTC minute, 0 to 59	R/W
40870	RTC second, 0 to 59	R/W
40871	Total number of log records, low word	R
40872	Total number of log records, high word	R
40873	The starting record to read log data, low word	R/W
40874	The starting record to read log data, high word	R/W
40875	The status of the data logging, 0: stopped, 1: running	R
40876	The data logger command, 0: stop, 1: run, 2: run in period mode	R/W
40877	Continue writing when data logger is full, 0: no, 1: yes	R/W
40878	Hour of the data logger sampling period, 0 ~ 24	R/W
40879	Minute of the data logger sampling period, 0 ~ 59	R/W
40880	Second of the data logger sampling period, 0 ~ 59	R/W
40881	Starting year when logging in period mode, 2000 ~ 2159	R/W
40882	Starting month when logging in period mode, 1 ~ 12	R/W
40883	Starting date when logging in period mode, 1 ~ 31	R/W
40884	Starting hour when logging in period mode, 0 ~ 23	R/W
40885	Starting minute when logging in period mode, 0 ~ 59	R/W
40886	Starting second when logging in period mode, 0 ~ 59	R/W
40887	Ending year when logging in period mode, 2000 ~ 2159	R/W
40888	Ending month when logging in period mode, 1 ~ 12	R/W
40889	Ending date when logging in period mode, 1 ~ 31	R/W
40890	Ending hour when logging in period mode, 0 ~ 23	R/W
40891	Ending minute when logging in period mode, 0 ~ 59	R/W
40892	Ending second when logging in period mode, 0 ~ 59	R/W
00001	Digital output value of channel 0	R/W
00129	Safe value of digital output channel 0	R/W
00161	Power on value of digital output channel 0	R/W

Address	Description	Attribute
00227	Write 1 to reload default TCP settings Only for Modbus TCP protocol	W
00234	Write 1 to reboot module Only for Modbus TCP protocol	W
00257	RS-485 Protocol, 0: DCON, 1: Modbus RTU Only for Modbus RTU protocol	R/W
00260	Modbus RTU host watchdog mode 0: same as I-7000 1: can use AO and DO command to clear host watchdog timeout status Only for Modbus RTU protocol	R/W
00261	RS-485 host watchdog mode, 1: enable, 0: disable. Only for Modbus RTU protocol	R/W
00262	Write 1 to play notification sound	W
00270	Host watch dog timeout status, write 1 to clear host watch dog timeout status Only for Modbus RTU protocol	R/W
00273	Reset status, 1: first read after powered on, 0: not the first read after powered on Only for Modbus RTU protocol	R
00280	Write 1 to clear all high latched analog input values	W
00281	Write 1 to clear all low latched analog input values	W
00291 ~ 00295	Low alarm status of channel 2 to 6. Write 1 to clear low latched alarm.	R/W
00305 ~ 00311	High alarm status of channel 0 to 6. Write 1 to clear high latched alarm.	R/W
00321 ~ 00327	Enable/disable alarm of channel 0 to 6	R/W
00337 ~ 00343	Alarm type, momentary or latched, of channel 0 to 6	R/W
00385 ~ 00391	Write 1 to clear high latched analog input value of channel 0 to 6	W
00417 ~ 00423	Write 1 to clear low latched analog input value of channel 0 to 6	W
00449 ~ 00455	Enable/disable beep on alarm for channel 0 to 6	R/W

C-4. CL-204-E Modbus Address Mappings (Base 1)

Address	Description	Attribute
30001 ~ 30007 40001 ~ 40007	Analog input value of channel 0 to 6. channel 0: HCHO in 1ppb, channel 1: TVOC in 1ppb, channel 2: relative humidity in 0.01%, channel 3: temperature in 0.01℃, channel 4:tempera ture in 0.01ℱ, channel 5: dew point temperature in 0.01℃, channel 6: dew point temperature in 0.01ℱ	R
40225 ~ 40231	High alarm limit of channel 0 to 6, channel 0: HCHO in 1ppb, channel 1: TVOC in 1ppb, channel 2: relative humidity in 0.01%, channel 3: temperature in 0.01℃, channel 4:tempera ture in 0.01ℱ, channel 5: dew point temperature in 0.01℃, channel 6: dew point temperature in 0.01ℱ	R/W
40235 ~ 40239	Low alarm limit of channel 2 to 6, channel 2: relative humidity in 0.01%, channel 3: temperature in 0.01℃, channel 4: temperature in 0.01ℱ, channel 5: dew point temperature in 0.01 ℃, channel 6: dew point temperature in 0.01ℱ	R/W
40272	Modbus NetID Only for Modbus TCP protocol	R/W
30301 40301	Number of the digital input channels Only for Modbus TCP protocol	R
30311 40311	Number of the digital output channels Only for Modbus TCP protocol	R
30321 40321	Number of the analog input channels Only for Modbus TCP protocol	R
30331 40331	Number of the analog output channels Only for Modbus TCP protocol	R
30352 40352	Firmware version in hex format Only for Modbus TCP protocol	R
40449	HCHO offset in 1 ppb	R/W
40450	TVOC offset in 1 ppb	R/W
40451	Relative humidity offset in 0.01%	R/W
40452	Temperature offset in 0.01℃	R/W
40481	Firmware version (low word)	R
40482	Firmware version (high word)	R
40483	Module name (low word), 0x0204	R
40484	Module name (high word), 0x434C	R

Address	Description	Attribute
40485	RS-485 module address, 1 to 247 Only for Modbus RTU protocol	R/W
40486	RS-485 baud rate and parity settings Bits 5:0 Baud rate, valid range: 3 ~ 10 Bits 7:6 00: no parity, 1 stop bit 01: no parity, 2 stop bit 10: even parity, 1 stop bit 11: odd parity , 1 stop bit Only for Modbus RTU protocol	R/W
40488	RS-485 response delay time in ms, valid range, 0 ~ 30 Only for Modbus RTU protocol	R/W
40489	RS-485 host watchdog timeout value, 0 ~ 255, in 0.1s Only for Modbus RTU protocol	R/W
40492	RS-485 host watchdog timeout count, write 0 to clear Only for Modbus RTU protocol	R/W
40497	Beep on alarm, 0: disable, 1 to 250: beep on alarm time in seconds, 251: beep on alarm continuously	R/W
30513 ~ 30519 40513 ~ 40519	High latched analog input value of channel 0 to 6	R
30545 ~ 30551 40545 ~ 40551	Low latched analog input value of channel 0 to 6	R
30556 40556	Module reset status, 1: power-on, 2: watchdog, 3: software reset command Only for Modbus TCP protocol	R
40558	Ethernet host watchdog timeout value, 5 to 65535, in second, 0 to disable. Only for Modbus TCP protocol	R/W
30559 40559	Ethernet host watchdog timeout count. Only for Modbus TCP protocol	R
30560 40560	Module name, 0x0204 Only for Modbus TCP protocol	R

Address	Description	Attribute
40564	TCP disconnection timeout value, 5 to 65535, in second, 0 to disable. Only for Modbus TCP protocol	R/W
40565	Module reset timeout value, 30 to 65535, in second, 0 to disable. Only for Modbus TCP protocol	R/W
40865	RTC year, 2000 to 2159	R/W
40866	RTC month, 1 to 12	R/W
40867	RTC date, 1 to 31	R/W
40868	RTC hour, 0 to 23	R/W
40869	RTC minute, 0 to 59	R/W
40870	RTC second, 0 to 59	R/W
40871	Total number of log records, low word	R
40872	Total number of log records, high word	R
40873	The starting record to read log data, low word	R/W
40874	The starting record to read log data, high word	R/W
40875	The status of the data logging, 0: stopped, 1: running	R
40876	The data logger command, 0: stop, 1: run, 2: run in period mode	R/W
40877	Continue writing when data logger is full, 0: no, 1: yes	R/W
40878	Hour of the data logger sampling period, 0 ~ 24	R/W
40879	Minute of the data logger sampling period, 0 ~ 59	R/W
40880	Second of the data logger sampling period, 0 ~ 59	R/W
40881	Starting year when logging in period mode, 2000 ~ 2159	R/W
40882	Starting month when logging in period mode, 1 ~ 12	R/W
40883	Starting date when logging in period mode, 1 ~ 31	R/W
40884	Starting hour when logging in period mode, 0 ~ 23	R/W
40885	Starting minute when logging in period mode, 0 ~ 59	R/W
40886	Starting second when logging in period mode, 0 ~ 59	R/W
40887	Ending year when logging in period mode, 2000 ~ 2159	R/W
40888	Ending month when logging in period mode, 1 ~ 12	R/W
40889	Ending date when logging in period mode, 1 ~ 31	R/W
40890	Ending hour when logging in period mode, 0 ~ 23	R/W
40891	Ending minute when logging in period mode, 0 ~ 59	R/W
40892	Ending second when logging in period mode, 0 ~ 59	R/W
00001	Digital output value of channel 0	R/W
00129	Safe value of digital output channel 0	R/W
00161	Power on value of digital output channel 0	R/W

Address	Description	Attribute
00227	Write 1 to reload default TCP settings Only for Modbus TCP protocol	W
00234	Write 1 to reboot module Only for Modbus TCP protocol	W
00257	RS-485 Protocol, 0: DCON, 1: Modbus RTU Only for Modbus RTU protocol	R/W
00260	Modbus RTU host watchdog mode 0: same as I-7000 1: can use AO and DO command to clear host watchdog timeout status Only for Modbus RTU protocol	R/W
00261	RS-485 host watchdog mode, 1: enable, 0: disable. Only for Modbus RTU protocol	R/W
00262	Write 1 to play notification sound	W
00270	Host watch dog timeout status, write 1 to clear host watch dog timeout status Only for Modbus RTU protocol	R/W
00273	Reset status, 1: first read after powered on, 0: not the first read after powered on Only for Modbus RTU protocol	R
00280	Write 1 to clear all high latched analog input values	W
00281	Write 1 to clear all low latched analog input values	W
00291 ~ 00295	Low alarm status of channel 2 to 6. Write 1 to clear low latched alarm.	R/W
00305 ~ 00311	High alarm status of channel 0 to 6. Write 1 to clear high latched alarm.	R/W
00321 ~ 00327	Enable/disable alarm of channel 0 to 6	R/W
00337 ~ 00343	Alarm type, momentary or latched, of channel 0 to 6	R/W
00385 ~ 00391	Write 1 to clear high latched analog input value of channel 0 to 6	W
00417 ~ 00423	Write 1 to clear low latched analog input value of channel 0 to 6	W
00449 ~ 00455	Enable/disable beep on alarm for channel 0 to 6	R/W

C-5. CL-205-E Modbus Address Mappings (Base 1)

Address	Description	Attribute
30001 ~ 30006 40001 ~ 40006	Analog input value of channel 0 to 5. channel 0: NH ₃ in 1ppm, channel 1: relative humidity in 0.01%, channel 2: temperature in 0.01°C, channel 3:temperature in 0.01°F, channel 4: dew point temperature in 0.01°C, channel 5: dew point tempera ture in 0.01°F	R
40225 ~ 40230	High alarm limit of channel 0 to 5, channel 0: NH ₃ in 1ppm, channel 1: relative humidity in 0.01%, channel 2: temperature in 0.01°C, channel 3:temperature in 0.01°F, channel 4: dew poi nt temperature in 0.01°C, channel 5: dew point tempera ture in 0.01°F	R/W
40235 ~ 40238	Low alarm limit of channel 1 to 5, channel 1: relative humidity in 0.01%, channel 2: temperature in 0.01°C, channel 3: temperature in 0.01°F, channel 4: dew point temperature in 0.01 °C, channel 5: dew point temperature in 0.01°F	R/W
40272	Modbus NetID Only for Modbus TCP protocol	R/W
30301 40301	Number of the digital input channels Only for Modbus TCP protocol	R
30311 40311	Number of the digital output channels Only for Modbus TCP protocol	R
30321 40321	Number of the analog input channels Only for Modbus TCP protocol	R
30331 40331	Number of the analog output channels Only for Modbus TCP protocol	R
30352 40352	Firmware version in hex format Only for Modbus TCP protocol	R
40449	NH ₃ offset in 1 ppm	R/W
40450	Relative humidity offset in 0.01%	R/W
40451	Temperature offset in 0.01°C	R/W
40481	Firmware version (low word)	R
40482	Firmware version (high word)	R
40483	Module name (low word), 0x0205	R
40484	Module name (high word), 0x434C	R
40485	RS-485 module address, 1 to 247 Only for Modbus RTU protocol	R/W

Address	Description	Attribute
40486	RS-485 baud rate and parity settings Bits 5:0 Baud rate, valid range: 3 ~ 10 Bits 7:6 00: no parity, 1 stop bit 01: no parity, 2 stop bit 10: even parity, 1 stop bit 11: odd parity , 1 stop bit Only for Modbus RTU protocol	R/W
40488	RS-485 response delay time in ms, valid range, 0 ~ 30 Only for Modbus RTU protocol	R/W
40489	RS-485 host watchdog timeout value, 0 ~ 255, in 0.1s Only for Modbus RTU protocol	R/W
40492	RS-485 host watchdog timeout count, write 0 to clear Only for Modbus RTU protocol	R/W
40497	Beep on alarm, 0: disable, 1 to 250: beep on alarm time in seconds, 251: beep on alarm continuously	R/W
30513 ~ 30518 40513 ~ 40518	High latched analog input value of channel 0 to 5	R
30545 ~ 30550 40545 ~ 40550	Low latched analog input value of channel 0 to 5	R
30556 40556	Module reset status, 1: power-on, 2: watchdog, 3: software reset command Only for Modbus TCP protocol	R
40558	Ethernet host watchdog timeout value, 5 to 65535, in second, 0 to disable. Only for Modbus TCP protocol	R/W
30559 40559	Ethernet host watchdog timeout count. Only for Modbus TCP protocol	R
30560 40560	Module name, 0x0205 Only for Modbus TCP protocol	R

Address	Description	Attribute
40564	TCP disconnection timeout value, 5 to 65535, in second, 0 to disable. Only for Modbus TCP protocol	R/W
40565	Module reset timeout value, 30 to 65535, in second, 0 to disable. Only for Modbus TCP protocol	R/W
40865	RTC year, 2000 to 2159	R/W
40866	RTC month, 1 to 12	R/W
40867	RTC date, 1 to 31	R/W
40868	RTC hour, 0 to 23	R/W
40869	RTC minute, 0 to 59	R/W
40870	RTC second, 0 to 59	R/W
40871	Total number of log records, low word	R
40872	Total number of log records, high word	R
40873	The starting record to read log data, low word	R/W
40874	The starting record to read log data, high word	R/W
40875	The status of the data logging, 0: stopped, 1: running	R
40876	The data logger command, 0: stop, 1: run, 2: run in period mode	R/W
40877	Continue writing when data logger is full, 0: no, 1: yes	R/W
40878	Hour of the data logger sampling period, 0 ~ 24	R/W
40879	Minute of the data logger sampling period, 0 ~ 59	R/W
40880	Second of the data logger sampling period, 0 ~ 59	R/W
40881	Starting year when logging in period mode, 2000 ~ 2159	R/W
40882	Starting month when logging in period mode, 1 ~ 12	R/W
40883	Starting date when logging in period mode, 1 ~ 31	R/W
40884	Starting hour when logging in period mode, 0 ~ 23	R/W
40885	Starting minute when logging in period mode, 0 ~ 59	R/W
40886	Starting second when logging in period mode, 0 ~ 59	R/W
40887	Ending year when logging in period mode, 2000 ~ 2159	R/W
40888	Ending month when logging in period mode, 1 ~ 12	R/W
40889	Ending date when logging in period mode, 1 ~ 31	R/W
40890	Ending hour when logging in period mode, 0 ~ 23	R/W
40891	Ending minute when logging in period mode, 0 ~ 59	R/W
40892	Ending second when logging in period mode, 0 ~ 59	R/W
40929	The first fan off period in a day, beginning hour, 0 ~ 23	R/W
40930	The first fan off period in a day, beginning minute, 0 ~ 59	R/W
40931	The first fan off period in a day, ending hour, 0 ~ 23	R/W

Address	Description	Attribute
40932	The first fan off period in a day, ending minute, 0 ~ 59	R/W
40933 ~ 40936	The second fan off period in a day	R/W
40937 ~ 40940	The third fan off period in a day	R/W
40941 ~ 40944	The fourth fan off period in a day	R/W
40945 ~ 40948	The fifth fan off period in a day	R/W
40949 ~ 40952	The sixth fan off period in a day	R/W
00001	Digital output value of channel 0	R/W
00129	Safe value of digital output channel 0	R/W
00161	Power on value of digital output channel 0	R/W
00227	Write 1 to reload default TCP settings Only for Modbus TCP protocol	W
00234	Write 1 to reboot module Only for Modbus TCP protocol	W
00257	RS-485 Protocol, 0: DCON, 1: Modbus RTU Only for Modbus RTU protocol	R/W
00260	Modbus RTU host watchdog mode 0: same as I-7000 1: can use AO and DO command to clear host watchdog timeout status Only for Modbus RTU protocol	R/W
00261	RS-485 host watchdog mode, 1: enable, 0: disable. Only for Modbus RTU protocol	R/W
00262	Write 1 to play notification sound	W
00270	Host watch dog timeout status, write 1 to clear host watch dog timeout status Only for Modbus RTU protocol	R/W
00273	Reset status, 1: first read after powered on, 0: not the first read after powered on Only for Modbus RTU protocol	R
00279	Fan control, 0: off, 1: on	R/W
00280	Write 1 to clear all high latched analog input values	W
00281	Write 1 to clear all low latched analog input values	W

Address	Description	Attribute
00291 ~ 00294	Low alarm status of channel 2 to 5. Write 1 to clear low latched alarm.	R/W
00305 ~ 00310	High alarm status of channel 0 to 5. Write 1 to clear high latched alarm.	R/W
00321 ~ 00326	Enable/disable alarm of channel 0 to 5	R/W
00337 ~ 00342	Alarm type, momentary or latched, of channel 0 to 5	R/W
00385 ~ 00390	Write 1 to clear high latched analog input value of channel 0 to 5	W
Address	Description	Attribute
00417 ~ 00422	Write 1 to clear low latched analog input value of channel 0 to 5	W
00449 ~ 00454	Enable/disable beep on alarm for channel 0 to 5	R/W

C-6. CL-206-E Modbus Address Mappings (Base 1)

Address	Description	Attribute
30001 ~ 30006 40001 ~ 40006	Analog input value of channel 0 to 5. channel 0: H ₂ S in 1ppm, channel 1: relative humidity in 0.01%, channel 2: temperature in 0.01°C, channel 3:temperature in 0.01°F, channel 4: dew point temperature in 0.01°C, channel 5: dew point tempera ture in 0.01°F	R
40225 ~ 40230	High alarm limit of channel 0 to 5, channel 0: H ₂ S in 1ppm, channel 1: relative humidity in 0.01%, channel 2: temperature in 0.01°C, channel 3:temperature in 0.01°F, channel 4: dew poi nt temperature in 0.01°C, channel 5: dew point tempera ture in 0.01°F	R/W
40235 ~ 40238	Low alarm limit of channel 1 to 5, channel 1: relative humidity in 0.01%, channel 2: temperature in 0.01°C, channel 3: temperature in 0.01°F, channel 4: dew point temperature in 0.01 °C, channel 5: dew point temperature in 0.01°F	R/W
40272	Modbus NetID Only for Modbus TCP protocol	R/W
30301 40301	Number of the digital input channels Only for Modbus TCP protocol	R
30311 40311	Number of the digital output channels Only for Modbus TCP protocol	R
30321 40321	Number of the analog input channels Only for Modbus TCP protocol	R
30331 40331	Number of the analog output channels Only for Modbus TCP protocol	R
30352 40352	Firmware version in hex format Only for Modbus TCP protocol	R
40449	H ₂ S offset in 1 ppm	R/W
40450	Relative humidity offset in 0.01%	R/W
40451	Temperature offset in 0.01°C	R/W
40481	Firmware version (low word)	R
40482	Firmware version (high word)	R
40483	Module name (low word), 0x0206	R
40484	Module name (high word), 0x434C	R
40485	RS-485 module address, 1 to 247 Only for Modbus RTU protocol	R/W

Address	Description	Attribute
40486	RS-485 baud rate and parity settings Bits 5:0 Baud rate, valid range: 3 ~ 10 Bits 7:6 00: no parity, 1 stop bit 01: no parity, 2 stop bit 10: even parity, 1 stop bit 11: odd parity , 1 stop bit Only for Modbus RTU protocol	R/W
40488	RS-485 response delay time in ms, valid range, 0 ~ 30 Only for Modbus RTU protocol	R/W
40489	RS-485 host watchdog timeout value, 0 ~ 255, in 0.1s Only for Modbus RTU protocol	R/W
40492	RS-485 host watchdog timeout count, write 0 to clear Only for Modbus RTU protocol	R/W
40497	Beep on alarm, 0: disable, 1 to 250: beep on alarm time in seconds, 251: beep on alarm continuously	R/W
30513 ~ 30518 40513 ~ 40518	High latched analog input value of channel 0 to 5	R
30545 ~ 30550 40545 ~ 40550	Low latched analog input value of channel 0 to 5	R
30556 40556	Module reset status, 1: power-on, 2: watchdog, 3: software reset command Only for Modbus TCP protocol	R
40558	Ethernet host watchdog timeout value, 5 to 65535, in second, 0 to disable. Only for Modbus TCP protocol	R/W
30559 40559	Ethernet host watchdog timeout count. Only for Modbus TCP protocol	R
30560 40560	Module name, 0x0206 Only for Modbus TCP protocol	R

Address	Description	Attribute
40564	TCP disconnection timeout value, 5 to 65535, in second, 0 to disable. Only for Modbus TCP protocol	R/W
40565	Module reset timeout value, 30 to 65535, in second, 0 to disable. Only for Modbus TCP protocol	R/W
40865	RTC year, 2000 to 2159	R/W
40866	RTC month, 1 to 12	R/W
40867	RTC date, 1 to 31	R/W
40868	RTC hour, 0 to 23	R/W
40869	RTC minute, 0 to 59	R/W
40870	RTC second, 0 to 59	R/W
40871	Total number of log records, low word	R
40872	Total number of log records, high word	R
40873	The starting record to read log data, low word	R/W
40874	The starting record to read log data, high word	R/W
40875	The status of the data logging, 0: stopped, 1: running	R
40876	The data logger command, 0: stop, 1: run, 2: run in period mode	R/W
40877	Continue writing when data logger is full, 0: no, 1: yes	R/W
40878	Hour of the data logger sampling period, 0 ~ 24	R/W
40879	Minute of the data logger sampling period, 0 ~ 59	R/W
40880	Second of the data logger sampling period, 0 ~ 59	R/W
40881	Starting year when logging in period mode, 2000 ~ 2159	R/W
40882	Starting month when logging in period mode, 1 ~ 12	R/W
40883	Starting date when logging in period mode, 1 ~ 31	R/W
40884	Starting hour when logging in period mode, 0 ~ 23	R/W
40885	Starting minute when logging in period mode, 0 ~ 59	R/W
40886	Starting second when logging in period mode, 0 ~ 59	R/W
40887	Ending year when logging in period mode, 2000 ~ 2159	R/W
40888	Ending month when logging in period mode, 1 ~ 12	R/W
40889	Ending date when logging in period mode, 1 ~ 31	R/W
40890	Ending hour when logging in period mode, 0 ~ 23	R/W
40891	Ending minute when logging in period mode, 0 ~ 59	R/W
40892	Ending second when logging in period mode, 0 ~ 59	R/W
40929	The first fan off period in a day, beginning hour, 0 ~ 23	R/W
40930	The first fan off period in a day, beginning minute, 0 ~ 59	R/W
40931	The first fan off period in a day, ending hour, 0 ~ 23	R/W

Address	Description	Attribute
40932	The first fan off period in a day, ending minute, 0 ~ 59	R/W
40933 ~ 40936	The second fan off period in a day	R/W
40937 ~ 40940	The third fan off period in a day	R/W
40941 ~ 40944	The fourth fan off period in a day	R/W
40945 ~ 40948	The fifth fan off period in a day	R/W
40949 ~ 40952	The sixth fan off period in a day	R/W
00001	Digital output value of channel 0	R/W
00129	Safe value of digital output channel 0	R/W
00161	Power on value of digital output channel 0	R/W
00227	Write 1 to reload default TCP settings Only for Modbus TCP protocol	W
00234	Write 1 to reboot module Only for Modbus TCP protocol	W
00257	RS-485 Protocol, 0: DCON, 1: Modbus RTU Only for Modbus RTU protocol	R/W
00260	Modbus RTU host watchdog mode 0: same as I-7000 1: can use AO and DO command to clear host watchdog timeout status Only for Modbus RTU protocol	R/W
00261	RS-485 host watchdog mode, 1: enable, 0: disable. Only for Modbus RTU protocol	R/W
00262	Write 1 to play notification sound	W
00270	Host watch dog timeout status, write 1 to clear host watch dog timeout status Only for Modbus RTU protocol	R/W
00273	Reset status, 1: first read after powered on, 0: not the first read after powered on Only for Modbus RTU protocol	R
00279	Fan control, 0: off, 1: on	R/W
00280	Write 1 to clear all high latched analog input values	W
00281	Write 1 to clear all low latched analog input values	W

Address	Description	Attribute
00291 ~ 00294	Low alarm status of channel 2 to 5. Write 1 to clear low latched alarm.	R/W
00305 ~ 00310	High alarm status of channel 0 to 5. Write 1 to clear high latched alarm.	R/W
00321 ~ 00326	Enable/disable alarm of channel 0 to 5	R/W
00337 ~ 00342	Alarm type, momentary or latched, of channel 0 to 5	R/W
00385 ~ 00390	Write 1 to clear high latched analog input value of channel 0 to 5	W
00417 ~ 00422	Write 1 to clear low latched analog input value of channel 0 to 5	W
00449 ~ 00454	Enable/disable beep on alarm for channel 0 to 5	R/W

C-7. CL-207-E Modbus Address Mappings (Base 1)

Address	Description	Attribute
30001 ~ 30006 40001 ~ 40006	Analog input value of channel 0 to 5. channel 0: HCHO in 1ppb, channel 1: relative humidity in 0.01%, channel 2: temperature in 0.01°C, channel 3:temperature in 0.01°F, channel 4: dew point temperature in 0.01°C, channel 5: dew point tempera ture in 0.01°F	R
40225 ~ 40230	High alarm limit of channel 0 to 5, channel 0: HCHO in 1ppb, channel 1: relative humidity in 0.01%, channel 2: temperature in 0.01°C, channel 3:temperature in 0.01°F, channel 4: dew point temperature in 0.01°C, channel 5: dew point tempera ture in 0.01°F	R/W
40235 ~ 40238	Low alarm limit of channel 1 to 5, channel 1: relative humidity in 0.01%, channel 2: temperature in 0.01°C, channel 3: temperature in 0.01°F, channel 4: dew point temperature in 0.01 °C, channel 5: dew point temperature in 0.01°F	R/W
40272	Modbus NetID Only for Modbus TCP protocol	R/W
30301 40301	Number of the digital input channels Only for Modbus TCP protocol	R
30311 40311	Number of the digital output channels Only for Modbus TCP protocol	R
30321 40321	Number of the analog input channels Only for Modbus TCP protocol	R
30331 40331	Number of the analog output channels Only for Modbus TCP protocol	R
30352 40352	Firmware version in hex format Only for Modbus TCP protocol	R
40449	HCHO offset in 1 ppb	R/W
40450	Relative humidity offset in 0.01%	R/W
40451	Temperature offset in 0.01°C	R/W
40481	Firmware version (low word)	R
40482	Firmware version (high word)	R
40483	Module name (low word), 0x0207	R
40484	Module name (high word), 0x434C	R
40485	RS-485 module address, 1 to 247 Only for Modbus RTU protocol	R/W

Address	Description	Attribute
40486	RS-485 baud rate and parity settings Bits 5:0 Baud rate, valid range: 3 ~ 10 Bits 7:6 00: no parity, 1 stop bit 01: no parity, 2 stop bit 10: even parity, 1 stop bit 11: odd parity , 1 stop bit Only for Modbus RTU protocol	R/W
40488	RS-485 response delay time in ms, valid range, 0 ~ 30 Only for Modbus RTU protocol	R/W
40489	RS-485 host watchdog timeout value, 0 ~ 255, in 0.1s Only for Modbus RTU protocol	R/W
40492	RS-485 host watchdog timeout count, write 0 to clear Only for Modbus RTU protocol	R/W
40497	Beep on alarm, 0: disable, 1 to 250: beep on alarm time in seconds, 251: beep on alarm continuously	R/W
30513 ~ 30518 40513 ~ 40518	High latched analog input value of channel 0 to 5	R
30545 ~ 30550 40545 ~ 40550	Low latched analog input value of channel 0 to 5	R
30556 40556	Module reset status, 1: power-on, 2: watchdog, 3: software reset command Only for Modbus TCP protocol	R
40558	Ethernet host watchdog timeout value, 5 to 65535, in second, 0 to disable. Only for Modbus TCP protocol	R/W
30559 40559	Ethernet host watchdog timeout count. Only for Modbus TCP protocol	R
30560 40560	Module name, 0x0207 Only for Modbus TCP protocol	R

Address	Description	Attribute
40564	TCP disconnection timeout value, 5 to 65535, in second, 0 to disable. Only for Modbus TCP protocol	R/W
40565	Module reset timeout value, 30 to 65535, in second, 0 to disable. Only for Modbus TCP protocol	R/W
40865	RTC year, 2000 to 2159	R/W
40866	RTC month, 1 to 12	R/W
40867	RTC date, 1 to 31	R/W
40868	RTC hour, 0 to 23	R/W
40869	RTC minute, 0 to 59	R/W
40870	RTC second, 0 to 59	R/W
40871	Total number of log records, low word	R
40872	Total number of log records, high word	R
40873	The starting record to read log data, low word	R/W
40874	The starting record to read log data, high word	R/W
40875	The status of the data logging, 0: stopped, 1: running	R
40876	The data logger command, 0: stop, 1: run, 2: run in period mode	R/W
40877	Continue writing when data logger is full, 0: no, 1: yes	R/W
40878	Hour of the data logger sampling period, 0 ~ 24	R/W
40879	Minute of the data logger sampling period, 0 ~ 59	R/W
40880	Second of the data logger sampling period, 0 ~ 59	R/W
40881	Starting year when logging in period mode, 2000 ~ 2159	R/W
40882	Starting month when logging in period mode, 1 ~ 12	R/W
40883	Starting date when logging in period mode, 1 ~ 31	R/W
40884	Starting hour when logging in period mode, 0 ~ 23	R/W
40885	Starting minute when logging in period mode, 0 ~ 59	R/W
40886	Starting second when logging in period mode, 0 ~ 59	R/W
40887	Ending year when logging in period mode, 2000 ~ 2159	R/W
40888	Ending month when logging in period mode, 1 ~ 12	R/W
40889	Ending date when logging in period mode, 1 ~ 31	R/W
40890	Ending hour when logging in period mode, 0 ~ 23	R/W
40891	Ending minute when logging in period mode, 0 ~ 59	R/W
40892	Ending second when logging in period mode, 0 ~ 59	R/W
40929	The first fan off period in a day, beginning hour, 0 ~ 23	R/W
40930	The first fan off period in a day, beginning minute, 0 ~ 59	R/W
40931	The first fan off period in a day, ending hour, 0 ~ 23	R/W

Address	Description	Attribute
40932	The first fan off period in a day, ending minute, 0 ~ 59	R/W
40933 ~ 40936	The second fan off period in a day	R/W
40937 ~ 40940	The third fan off period in a day	R/W
40941 ~ 40944	The fourth fan off period in a day	R/W
40945 ~ 40948	The fifth fan off period in a day	R/W
40949 ~ 40952	The sixth fan off period in a day	R/W
00001	Digital output value of channel 0	R/W
00129	Safe value of digital output channel 0	R/W
00161	Power on value of digital output channel 0	R/W
00227	Write 1 to reload default TCP settings Only for Modbus TCP protocol	W
00234	Write 1 to reboot module Only for Modbus TCP protocol	W
00257	RS-485 Protocol, 0: DCON, 1: Modbus RTU Only for Modbus RTU protocol	R/W
00260	Modbus RTU host watchdog mode 0: same as I-7000 1: can use AO and DO command to clear host watchdog timeout status Only for Modbus RTU protocol	R/W
00261	RS-485 host watchdog mode, 1: enable, 0: disable. Only for Modbus RTU protocol	R/W
00262	Write 1 to play notification sound	W
00270	Host watch dog timeout status, write 1 to clear host watch dog timeout status Only for Modbus RTU protocol	R/W
00273	Reset status, 1: first read after powered on, 0: not the first read after powered on Only for Modbus RTU protocol	R
00279	Fan control, 0: off, 1: on	R/W
00280	Write 1 to clear all high latched analog input values	W
00281	Write 1 to clear all low latched analog input values	W

Address	Description	Attribute
00291 ~ 00294	Low alarm status of channel 2 to 5. Write 1 to clear low latched alarm.	R/W
00305 ~ 00310	High alarm status of channel 0 to 5. Write 1 to clear high latched alarm.	R/W
00321 ~ 00326	Enable/disable alarm of channel 0 to 5	R/W
00337 ~ 00342	Alarm type, momentary or latched, of channel 0 to 5	R/W
00385 ~ 00390	Write 1 to clear high latched analog input value of channel 0 to 5	W
00417 ~ 00422	Write 1 to clear low latched analog input value of channel 0 to 5	W
00449 ~ 00454	Enable/disable beep on alarm for channel 0 to 5	R/W

C-8. CL-208-E Modbus Address Mappings (Base 1)

Address	Description	Attribute
30001 ~ 30006 40001 ~ 40006	Analog input value of channel 0 to 5. channel 0: TVOC in 1ppb, channel 1: relative humidity in 0.01%, channel 2: temperature in 0.01°C, channel 3:temperature in 0.01°F, channel 4: dew point temperature in 0.01°C, channel 5: dew point temperature in 0.01°F	R
40225 ~ 40230	High alarm limit of channel 0 to 5, channel 0: TVOC in 1ppb, channel 1: relative humidity in 0.01%, channel 2: temperature in 0.01°C, channel 3:temperature in 0.01°F, channel 4: dew point temperature in 0.01°C, channel 5: dew point temperature in 0.01°F	R/W
40235 ~ 40238	Low alarm limit of channel 1 to 5, channel 1: relative humidity in 0.01%, channel 2: temperature in 0.01°C, channel 3: temperature in 0.01°F, channel 4: dew point temperature in 0.01 °C, channel 5: dew point temperature in 0.01°F	R/W
40272	Modbus NetID Only for Modbus TCP protocol	R/W
30301 40301	Number of the digital input channels Only for Modbus TCP protocol	R
30311 40311	Number of the digital output channels Only for Modbus TCP protocol	R
30321 40321	Number of the analog input channels Only for Modbus TCP protocol	R
30331 40331	Number of the analog output channels Only for Modbus TCP protocol	R
30352 40352	Firmware version in hex format Only for Modbus TCP protocol	R
40449	HCHO offset in 1 ppb	R/W
40450	Relative humidity offset in 0.01%	R/W
40451	Temperature offset in 0.01°C	R/W
40481	Firmware version (low word)	R
40482	Firmware version (high word)	R
40483	Module name (low word), 0x0208	R
40484	Module name (high word), 0x434C	R
40485	RS-485 module address, 1 to 247 Only for Modbus RTU protocol	R/W

Address	Description	Attribute
40486	RS-485 baud rate and parity settings Bits 5:0 Baud rate, valid range: 3 ~ 10 Bits 7:6 00: no parity, 1 stop bit 01: no parity, 2 stop bit 10: even parity, 1 stop bit 11: odd parity , 1 stop bit Only for Modbus RTU protocol	R/W
40488	RS-485 response delay time in ms, valid range, 0 ~ 30 Only for Modbus RTU protocol	R/W
40489	RS-485 host watchdog timeout value, 0 ~ 255, in 0.1s Only for Modbus RTU protocol	R/W
40492	RS-485 host watchdog timeout count, write 0 to clear Only for Modbus RTU protocol	R/W
40497	Beep on alarm, 0: disable, 1 to 250: beep on alarm time in seconds, 251: beep on alarm continuously	R/W
30513 ~ 30518 40513 ~ 40518	High latched analog input value of channel 0 to 5	R
30545 ~ 30550 40545 ~ 40550	Low latched analog input value of channel 0 to 5	R
30556 40556	Module reset status, 1: power-on, 2: watchdog, 3: software reset command Only for Modbus TCP protocol	R
40558	Ethernet host watchdog timeout value, 5 to 65535, in second, 0 to disable. Only for Modbus TCP protocol	R/W
30559 40559	Ethernet host watchdog timeout count. Only for Modbus TCP protocol	R
30560 40560	Module name, 0x0208 Only for Modbus TCP protocol	R

Address	Description	Attribute
40564	TCP disconnection timeout value, 5 to 65535, in second, 0 to disable. Only for Modbus TCP protocol	R/W
40565	Module reset timeout value, 30 to 65535, in second, 0 to disable. Only for Modbus TCP protocol	R/W
40865	RTC year, 2000 to 2159	R/W
40866	RTC month, 1 to 12	R/W
40867	RTC date, 1 to 31	R/W
40868	RTC hour, 0 to 23	R/W
40869	RTC minute, 0 to 59	R/W
40870	RTC second, 0 to 59	R/W
40871	Total number of log records, low word	R
40872	Total number of log records, high word	R
40873	The starting record to read log data, low word	R/W
40874	The starting record to read log data, high word	R/W
40875	The status of the data logging, 0: stopped, 1: running	R
40876	The data logger command, 0: stop, 1: run, 2: run in period mode	R/W
40877	Continue writing when data logger is full, 0: no, 1: yes	R/W
40878	Hour of the data logger sampling period, 0 ~ 24	R/W
40879	Minute of the data logger sampling period, 0 ~ 59	R/W
40880	Second of the data logger sampling period, 0 ~ 59	R/W
40881	Starting year when logging in period mode, 2000 ~ 2159	R/W
40882	Starting month when logging in period mode, 1 ~ 12	R/W
40883	Starting date when logging in period mode, 1 ~ 31	R/W
40884	Starting hour when logging in period mode, 0 ~ 23	R/W
40885	Starting minute when logging in period mode, 0 ~ 59	R/W
40886	Starting second when logging in period mode, 0 ~ 59	R/W
40887	Ending year when logging in period mode, 2000 ~ 2159	R/W
40888	Ending month when logging in period mode, 1 ~ 12	R/W
40889	Ending date when logging in period mode, 1 ~ 31	R/W
40890	Ending hour when logging in period mode, 0 ~ 23	R/W
40891	Ending minute when logging in period mode, 0 ~ 59	R/W
40892	Ending second when logging in period mode, 0 ~ 59	R/W
40929	The first fan off period in a day, beginning hour, 0 ~ 23	R/W
40930	The first fan off period in a day, beginning minute, 0 ~ 59	R/W
40931	The first fan off period in a day, ending hour, 0 ~ 23	R/W

Address	Description	Attribute
40932	The first fan off period in a day, ending minute, 0 ~ 59	R/W
40933 ~ 40936	The second fan off period in a day	R/W
40937 ~ 40940	The third fan off period in a day	R/W
40941 ~ 40944	The fourth fan off period in a day	R/W
40945 ~ 40948	The fifth fan off period in a day	R/W
40949 ~ 40952	The sixth fan off period in a day	R/W
00001	Digital output value of channel 0	R/W
00129	Safe value of digital output channel 0	R/W
00161	Power on value of digital output channel 0	R/W
00227	Write 1 to reload default TCP settings Only for Modbus TCP protocol	W
00234	Write 1 to reboot module Only for Modbus TCP protocol	W
00257	RS-485 Protocol, 0: DCON, 1: Modbus RTU Only for Modbus RTU protocol	R/W
00260	Modbus RTU host watchdog mode 0: same as I-7000 1: can use AO and DO command to clear host watchdog timeout status Only for Modbus RTU protocol	R/W
00261	RS-485 host watchdog mode, 1: enable, 0: disable. Only for Modbus RTU protocol	R/W
00262	Write 1 to play notification sound	W
00270	Host watch dog timeout status, write 1 to clear host watch dog timeout status Only for Modbus RTU protocol	R/W
00273	Reset status, 1: first read after powered on, 0: not the first read after powered on Only for Modbus RTU protocol	R
00279	Fan control, 0: off, 1: on	R/W
00280	Write 1 to clear all high latched analog input values	W
00281	Write 1 to clear all low latched analog input values	W

Address	Description	Attribute
00291 ~ 00294	Low alarm status of channel 2 to 5. Write 1 to clear low latched alarm.	R/W
00305 ~ 00310	High alarm status of channel 0 to 5. Write 1 to clear high latched alarm.	R/W
00321 ~ 00326	Enable/disable alarm of channel 0 to 5	R/W
00337 ~ 00342	Alarm type, momentary or latched, of channel 0 to 5	R/W
00385 ~ 00390	Write 1 to clear high latched analog input value of channel 0 to 5	W
00417 ~ 00422	Write 1 to clear low latched analog input value of channel 0 to 5	W
00449 ~ 00454	Enable/disable beep on alarm for channel 0 to 5	R/W

C-9. CL-210-E Modbus Address Mappings (Base 1)

Address	Description	Attribute
30001 ~ 30006 40001 ~ 40006	Analog input value of channel 0 to 5. channel 0: PM2.5 in 1ug/m ³ , channel 1: relative humidity in 0.01%, channel 2: temperature in 0.01°C, channel 3:temperature in 0.01°F, channel 4: dew point temperature in 0.01°C, channel 5: dew point temperature in 0.01°F	R
40225 ~ 40230	High alarm limit of channel 0 to 5, channel 0: PM2.5 in 1 ug/m ³ , channel 1: relative humidity in 0.01%, channel 2: temperature in 0.01°C, channel 3:temperature in 0.01°F, channel 4: dew point temperature in 0.01°C, channel 5: dew point temperature in 0.01°F	R/W
40235 ~ 40238	Low alarm limit of channel 1 to 5, channel 1: relative humidity in 0.01%, channel 2: temperature in 0.01°C, channel 3: temperature in 0.01°F, channel 4: dew point temperature in 0.01 °C, channel 5: dew point temperature in 0.01°F	R/W
40272	Modbus NetID Only for Modbus TCP protocol	R/W
30301 40301	Number of the digital input channels Only for Modbus TCP protocol	R
30311 40311	Number of the digital output channels Only for Modbus TCP protocol	R
30321 40321	Number of the analog input channels Only for Modbus TCP protocol	R
30331 40331	Number of the analog output channels Only for Modbus TCP protocol	R
30352 40352	Firmware version in hex format Only for Modbus TCP protocol	R
40449	PM2.5 offset in 1 ug/m3	R/W
40450	Relative humidity offset in 0.01%	R/W
40451	Temperature offset in 0.01°C	R/W
40481	Firmware version (low word)	R
40482	Firmware version (high word)	R
40483	Module name (low word), 0x0210	R
40484	Module name (high word), 0x434C	R
40485	RS-485 module address, 1 to 247 Only for Modbus RTU protocol	R/W

Address	Description	Attribute
40486	RS-485 baud rate and parity settings Bits 5:0 Baud rate, valid range: 3 ~ 10 Bits 7:6 00: no parity, 1 stop bit 01: no parity, 2 stop bit 10: even parity, 1 stop bit 11: odd parity , 1 stop bit Only for Modbus RTU protocol	R/W
40488	RS-485 response delay time in ms, valid range, 0 ~ 30 Only for Modbus RTU protocol	R/W
40489	RS-485 host watchdog timeout value, 0 ~ 255, in 0.1s Only for Modbus RTU protocol	R/W
40492	RS-485 host watchdog timeout count, write 0 to clear Only for Modbus RTU protocol	R/W
40497	Beep on alarm, 0: disable, 1 to 250: beep on alarm time in seconds, 251: beep on alarm continuously	R/W
30513 ~ 30518 40513 ~ 40518	High latched analog input value of channel 0 to 5	R
30545 ~ 30550 40545 ~ 40550	Low latched analog input value of channel 0 to 5	R
30556 40556	Module reset status, 1: power-on, 2: watchdog, 3: software reset command Only for Modbus TCP protocol	R
40558	Ethernet host watchdog timeout value, 5 to 65535, in second, 0 to disable. Only for Modbus TCP protocol	R/W
30559 40559	Ethernet host watchdog timeout count. Only for Modbus TCP protocol	R
30560 40560	Module name, 0x0210 Only for Modbus TCP protocol	R

Address	Description	Attribute
40564	TCP disconnection timeout value, 5 to 65535, in second, 0 to disable. Only for Modbus TCP protocol	R/W
40565	Module reset timeout value, 30 to 65535, in second, 0 to disable. Only for Modbus TCP protocol	R/W
40865	RTC year, 2000 to 2159	R/W
40866	RTC month, 1 to 12	R/W
40867	RTC date, 1 to 31	R/W
40868	RTC hour, 0 to 23	R/W
40869	RTC minute, 0 to 59	R/W
40870	RTC second, 0 to 59	R/W
40871	Total number of log records, low word	R
40872	Total number of log records, high word	R
40873	The starting record to read log data, low word	R/W
40874	The starting record to read log data, high word	R/W
40875	The status of the data logging, 0: stopped, 1: running	R
40876	The data logger command, 0: stop, 1: run, 2: run in period mode	R/W
40877	Continue writing when data logger is full, 0: no, 1: yes	R/W
40878	Hour of the data logger sampling period, 0 ~ 24	R/W
40879	Minute of the data logger sampling period, 0 ~ 59	R/W
40880	Second of the data logger sampling period, 0 ~ 59	R/W
40881	Starting year when logging in period mode, 2000 ~ 2159	R/W
40882	Starting month when logging in period mode, 1 ~ 12	R/W
40883	Starting date when logging in period mode, 1 ~ 31	R/W
40884	Starting hour when logging in period mode, 0 ~ 23	R/W
40885	Starting minute when logging in period mode, 0 ~ 59	R/W
40886	Starting second when logging in period mode, 0 ~ 59	R/W
40887	Ending year when logging in period mode, 2000 ~ 2159	R/W
40888	Ending month when logging in period mode, 1 ~ 12	R/W
40889	Ending date when logging in period mode, 1 ~ 31	R/W
40890	Ending hour when logging in period mode, 0 ~ 23	R/W
40891	Ending minute when logging in period mode, 0 ~ 59	R/W
40892	Ending second when logging in period mode, 0 ~ 59	R/W
40929	The first fan off period in a day, beginning hour, 0 ~ 23	R/W
40930	The first fan off period in a day, beginning minute, 0 ~ 59	R/W
40931	The first fan off period in a day, ending hour, 0 ~ 23	R/W

Address	Description	Attribute
40932	The first fan off period in a day, ending minute, 0 ~ 59	R/W
40933 ~ 40936	The second fan off period in a day	R/W
40937 ~ 40940	The third fan off period in a day	R/W
40941 ~ 40944	The fourth fan off period in a day	R/W
40945 ~ 40948	The fifth fan off period in a day	R/W
40949 ~ 40952	The sixth fan off period in a day	R/W
00001	Digital output value of channel 0	R/W
00129	Safe value of digital output channel 0	R/W
00161	Power on value of digital output channel 0	R/W
00227	Write 1 to reload default TCP settings Only for Modbus TCP protocol	W
00234	Write 1 to reboot module Only for Modbus TCP protocol	W
00257	RS-485 Protocol, 0: DCON, 1: Modbus RTU Only for Modbus RTU protocol	R/W
00260	Modbus RTU host watchdog mode 0: same as I-7000 1: can use AO and DO command to clear host watchdog timeout status Only for Modbus RTU protocol	R/W
00261	RS-485 host watchdog mode, 1: enable, 0: disable. Only for Modbus RTU protocol	R/W
00262	Write 1 to play notification sound	W
00270	Host watch dog timeout status, write 1 to clear host watch dog timeout status Only for Modbus RTU protocol	R/W
00273	Reset status, 1: first read after powered on, 0: not the first read after powered on Only for Modbus RTU protocol	R
00279	Fan control, 0: off, 1: on	R/W
00280	Write 1 to clear all high latched analog input values	W
00281	Write 1 to clear all low latched analog input values	W

Address	Description	Attribute
00291 ~ 00294	Low alarm status of channel 2 to 5. Write 1 to clear low latched alarm.	R/W
00305 ~ 00310	High alarm status of channel 0 to 5. Write 1 to clear high latched alarm.	R/W
00321 ~ 00326	Enable/disable alarm of channel 0 to 5	R/W
00337 ~ 00342	Alarm type, momentary or latched, of channel 0 to 5	R/W
00385 ~ 00390	Write 1 to clear high latched analog input value of channel 0 to 5	W
00417 ~ 00422	Write 1 to clear low latched analog input value of channel 0 to 5	W
00449 ~ 00454	Enable/disable beep on alarm for channel 0 to 5	R/W

C-10. CL-211 / CL-211-E Modbus Address Mappings (Base 1)

Address	Description	Attribute
30001 ~ 30007 40001 ~ 40007	Analog input value of channel 0 to 6. channel 0: CO in 1ppm, channel 1: PM2.5 in 1ug/m ³ , channel 2: relative humidity in 0.01%, channel 3: temperature in 0.01°C, channel 4:temperature in 0.01°F, channel 5: dew point temperature in 0.01°C, channel 6: dew point temperature in 0.01°F	R
40225 ~ 40231	High alarm limit of channel 0 to 6, channel 0: CO in 1ppm, channel 1: PM2.5 in 1ug/m ³ , channel 2: relative humidity in 0.01%, channel 3: temperature in 0.01°C, channel 4:temperature in 0.01°F, channel 5: dew point temperature in 0.01°C, channel 6: dew point temperature in 0.01°F	R/W
40235 ~ 40239	Low alarm limit of channel 2 to 6, channel 2: relative humidity in 0.01%, channel 3: temperature in 0.01°C, channel 4: temperature in 0.01°F, channel 5: dew point temperature in 0.01°C, channel 6: dew point temperature in 0.01°F	R/W
40272	Modbus NetID Only for Modbus TCP protocol	R/W
30301 40301	Number of the digital input channels Only for Modbus TCP protocol	R
30311 40311	Number of the digital output channels Only for Modbus TCP protocol	R
30321 40321	Number of the analog input channels Only for Modbus TCP protocol	R
30331 40331	Number of the analog output channels Only for Modbus TCP protocol	R
30352 40352	Firmware version in hex format Only for Modbus TCP protocol	R
40449	CO offset in 1 ppm	R/W

Address	Description	Attribute																				
40450	PM2.5 offset in 1 ug/m ³	R/W																				
40451	Relative humidity offset in 0.01%	R/W																				
40452	Temperature offset in 0.01°C	R/W																				
40481	Firmware version (low word)	R																				
40482	Firmware version (high word)	R																				
40483	Module name (low word), 0x0211	R																				
40484	Module name (high word), 0x434C	R																				
40485	RS-485 module address, 1 to 247	R/W																				
40486	<p>RS-485 baud rate and parity settings</p> <p>Bits 5:0</p> <p>Baud rate, valid range: 3 ~ 10</p> <table border="1"> <tbody> <tr> <td>Code</td> <td>0x03</td> <td>0x04</td> <td>0x05</td> <td>0x06</td> </tr> <tr> <td>Baud</td> <td>1200</td> <td>2400</td> <td>4800</td> <td>9600</td> </tr> <tr> <td>Code</td> <td>0x07</td> <td>0x08</td> <td>0x09</td> <td>0x0A</td> </tr> <tr> <td>Baud</td> <td>19200</td> <td>38400</td> <td>57600</td> <td>115200</td> </tr> </tbody> </table> <p>Bits 7:6</p> <p>00: no parity, 1 stop bit (N,8,1)</p> <p>01: no parity, 2 stop bits (N,8,2)</p> <p>10: even parity, 1 stop bit (E,8,1)</p> <p>11: odd parity, 1 stop bit (O,8,1)</p>	Code	0x03	0x04	0x05	0x06	Baud	1200	2400	4800	9600	Code	0x07	0x08	0x09	0x0A	Baud	19200	38400	57600	115200	R/W
Code	0x03	0x04	0x05	0x06																		
Baud	1200	2400	4800	9600																		
Code	0x07	0x08	0x09	0x0A																		
Baud	19200	38400	57600	115200																		
40488	RS-485 response delay time in ms, valid range, 0 to 30	R/W																				
40489	RS-485 host watchdog timeout value, 0 to 255, in 0.1s	R/W																				
40492	RS-485 host watchdog timeout count, write 0 to clear	R/W																				
40497	<p>Beep on alarm,</p> <p>0: disable,</p> <p>1 to 250: beep on alarm time in seconds,</p> <p>251: beep on alarm continuously</p>	R/W																				
30513 ~ 30519 40513 ~ 40519	<p>High latched analog input value of channel 0 to 6</p> <p>channel 0: CO in 1ppm,</p> <p>channel 1: PM2.5 in 1ug/m³,</p> <p>channel 2: relative humidity in 0.01%,</p> <p>channel 3: temperature in 0.01°C,</p> <p>channel 4: temperature in 0.01°F,</p> <p>channel 5: dew point temperature in 0.01°C,</p> <p>channel 6: dew point temperature in 0.01°F</p>	R																				

Address	Description	Attribute
30545 ~ 30551 40545 ~ 40551	Low latched analog input value of channel 0 to 6 channel 0: CO in 1ppm, channel 1: PM2.5 in 1ug/m ³ , channel 2: relative humidity in 0.01%, channel 3: temperature in 0.01°C, channel 4: temperature in 0.01°F, channel 5: dew point temperature in 0.01°C, channel 6: dew point temperature in 0.01°F	R
30556 40556	Module reset status, 1: power-on, 2: watchdog, 3: software reset command Only for Modbus TCP protocol	R
40558	Ethernet host watchdog timeout value, 5 to 65535, in second, 0 to disable. Only for Modbus TCP protocol	R/W
30559 40559	Ethernet host watchdog timeout count. Only for Modbus TCP protocol	R
30560 40560	Module name, 0x0213 Only for Modbus TCP protocol	R
40564	TCP disconnection timeout value, 5 to 65535, in second, 0 to disable. Only for Modbus TCP protocol	R/W
40565	Module reset timeout value, 30 to 65535, in second, 0 to disable. Only for Modbus TCP protocol	R/W
40865	RTC year, 2000 to 2159	R/W
40866	RTC month, 1 to 12	R/W
40867	RTC date, 1 to 31	R/W
40868	RTC hour, 0 to 23	R/W
40869	RTC minute, 0 to 59	R/W
40870	RTC second, 0 to 59	R/W
40871	Total number of log records, low word	R
40872	Total number of log records, high word	R
40873	The starting record to read log data, low word	R/W
40874	The starting record to read log data, high word	R/W
40875	The status of the data logging, 0: stopped, 1: running	R
40876	The data logger command, 0: stop, 1: run, 2: run in period mode	R/W
40877	Continue writing when data logger is full, 0: no, 1: yes	R/W
40878	Hour of the data logger sampling period, 0 to 24	R/W

Address	Description	Attribute
40879	Minute of the data logger sampling period, 0 to 59	R/W
40880	Second of the data logger sampling period, 0 to 59	R/W
40881	Starting year when logging in period mode, 2000 to 2159	R/W
40882	Starting month when logging in period mode, 1 to 12	R/W
40883	Starting date when logging in period mode, 1 to 31	R/W
40884	Starting hour when logging in period mode, 0 to 23	R/W
40885	Starting minute when logging in period mode, 0 to 59	R/W
40886	Starting second when logging in period mode, 0 to 59	R/W
40887	Ending year when logging in period mode, 2000 to 2159	R/W
40888	Ending month when logging in period mode, 1 to 12	R/W
40889	Ending date when logging in period mode, 1 to 31	R/W
40890	Ending hour when logging in period mode, 0 to 23	R/W
40891	Ending minute when logging in period mode, 0 to 59	R/W
40892	Ending second when logging in period mode, 0 to 59	R/W
40929	The first fan off period in a day, beginning hour, 0 to 23	R/W
40930	The first fan off period in a day, beginning minute, 0 to 59	R/W
40931	The first fan off period in a day, ending hour, 0 to 23	R/W
40932	The first fan off period in a day, ending minute, 0 to 59	R/W
40933 ~ 40936	The second fan off period in a day	R/W
40937 ~ 40940	The third fan off period in a day	R/W
40941 ~ 90944	The fourth fan off period in a day	R/W
40945 ~ 40948	The fifth fan off period in a day	R/W
40949 ~ 40952	The sixth fan off period in a day	R/W
00001	Digital output value of channel 0	R/W
00129	Safe value of digital output channel 0	R/W
00161	Power on value of digital output channel 0	R/W
00257	RS-485 Protocol, 0: DCON, 1: Modbus RTU	R/W
00227	Write 1 to reload default TCP settings Only for Modbus TCP protocol	W
00234	Write 1 to reboot module Only for Modbus TCP protocol	W

Address	Description	Attribute
00260	Modbus RTU host watchdog mode 0: same as I-7000 1: can use AO and DO command to clear host watchdog timeout status	R/W
00261	RS-485 host watchdog mode, 1: enable, 0: disable.	R/W
00262	Write 1 to play notification sound Only for CL-211-E	W
00270	Host watch dog timeout status, write 1 to clear host watch dog timeout status	R/W
00273	Reset status, 1: first read after powered on, 0: not the first read after powered on	R
00279	Fan control, 0: off, 1: on	R/W
00280	Write 1 to clear all high latched analog input values	W
00281	Write 1 to clear all low latched analog input values	W
00291 ~ 00295	Low alarm status of channel 2 to 6. Write 1 to clear low latched alarm. channel 2: relative humidity in 0.01%, channel 3: temperature in 0.01°C, channel 4: temperature in 0.01°F, channel 5: dew point temperature in 0.01°C, channel 6: dew point temperature in 0.01°F	R/W
00305 ~ 00311	High alarm status of channel 0 to 6. Write 1 to clear high latched alarm. channel 0: CO in 1ppm, channel 1: PM2.5 in 1ug/m ³ , channel 2: relative humidity in 0.01%, channel 3: temperature in 0.01°C, channel 4: temperature in 0.01°F, channel 5: dew point temperature in 0.01°C, channel 6: dew point temperature in 0.01°F	R/W

Address	Description	Attribute
00321 ~ 00327	Enable/disable alarm of channel 0 to 6, write 0 to disable alarm ; write 1 to enable alarm. channel 0: CO in 1ppm, channel 1: PM2.5 in 1ug/m ³ channel 2: relative humidity in 0.01%, channel 3: temperature in 0.01°C, channel 4: temperature in 0.01°F, channel 5: dew point temperature in 0.01°C, channel 6: dew point temperature in 0.01°F	R/W
00337 ~ 00343	Alarm type, momentary or latched, of channel 0 to 6, write 0 to enable momentary alarm mode; write 1 to enable latched alarm mode. channel 0: CO in 1ppm, channel 1: PM2.5 in 1ug/m ³ , channel 2: relative humidity in 0.01%, channel 3: temperature in 0.01°C, channel 4: temperature in 0.01°F, channel 5: dew point temperature in 0.01°C, channel 6: dew point temperature in 0.01°F	R/W
00385 ~ 00391	Write 1 to clear high latched analog input value of channel 0 to 6, channel 0: CO in 1ppm, channel 1: PM2.5 in 1ug/m ³ , channel 2: relative humidity in 0.01%, channel 3: temperature in 0.01°C, channel 4: temperature in 0.01°F, channel 5: dew point temperature in 0.01°C, channel 6: dew point temperature in 0.01°F	W
00417 ~ 00423	Write 1 to clear low latched analog input value of channel 0 to 6 channel 0: CO in 1ppm, channel 1: PM2.5 in 1ug/m ³ , channel 2: relative humidity in 0.01%, channel 3: temperature in 0.01°C, channel 4: temperature in 0.01°F, channel 5: dew point temperature in 0.01°C, channel 6: dew point temperature in 0.01°F	W
00449 ~ 00455	Enable/disable beep on alarm for channel 0 to 6	R/W

C-11. CL-212 / CL-212-E Modbus Address Mappings (Base 1)

Address	Description	Attribute
30001 ~ 30007 40001 ~ 40007	Analog input value of channel 0 to 6. channel 0: CO ₂ in 1ppm, channel 1: PM2.5 in 1ug/m ³ , channel 2: relative humidity in 0.01%, channel 3: temperature in 0.01°C, channel 4: temperature in 0.01°F, channel 5: dew point temperature in 0.01°C, channel 6: dew point temperature in 0.01°F	R
40225 ~ 40231	High alarm limit of channel 0 to 6, channel 0: CO ₂ in 1ppm, channel 1: PM2.5 in 1ug/m ³ , channel 2: relative humidity in 0.01%, channel 3: temperature in 0.01°C, channel 4: temperature in 0.01°F, channel 5: dew point temperature in 0.01°C, channel 6: dew point temperature in 0.01°F	R/W
40235 ~ 40239	Low alarm limit of channel 2 to 6, channel 2: relative humidity in 0.01%, channel 3: temperature in 0.01°C, channel 4: temperature in 0.01°F, channel 5: dew point temperature in 0.01°C, channel 6: dew point temperature in 0.01°F	R/W
40272	Modbus NetID Only for Modbus TCP protocol	R/W
30301 40301	Number of the digital input channels Only for Modbus TCP protocol	R
30311 40311	Number of the digital output channels Only for Modbus TCP protocol	R
30321 40321	Number of the analog input channels Only for Modbus TCP protocol	R
30331 40331	Number of the analog output channels Only for Modbus TCP protocol	R
30352 40352	Firmware version in hex format Only for Modbus TCP protocol	R
40449	CO ₂ offset in 1 ppm	R/W

Address	Description	Attribute																				
40450	PM2.5 offset in 1 ug/m ³	R/W																				
40451	Relative humidity offset in 0.01%	R/W																				
40452	Temperature offset in 0.01°C	R/W																				
40481	Firmware version (low word)	R																				
40482	Firmware version (high word)	R																				
40483	Module name (low word), 0x0212	R																				
40484	Module name (high word), 0x434C	R																				
40485	RS-485 module address, 1 to 247	R/W																				
40486	<p>RS-485 baud rate and parity settings</p> <p>Bits 5:0</p> <p>Baud rate, valid range: 3 ~ 10</p> <table border="1"> <tbody> <tr> <td>Code</td> <td>0x03</td> <td>0x04</td> <td>0x05</td> <td>0x06</td> </tr> <tr> <td>Baud</td> <td>1200</td> <td>2400</td> <td>4800</td> <td>9600</td> </tr> <tr> <td>Code</td> <td>0x07</td> <td>0x08</td> <td>0x09</td> <td>0x0A</td> </tr> <tr> <td>Baud</td> <td>19200</td> <td>38400</td> <td>57600</td> <td>115200</td> </tr> </tbody> </table> <p>Bits 7:6</p> <p>00: no parity, 1 stop bit (N,8,1)</p> <p>01: no parity, 2 stop bits (N,8,2)</p> <p>10: even parity, 1 stop bit (E,8,1)</p> <p>11: odd parity, 1 stop bit (O,8,1)</p>	Code	0x03	0x04	0x05	0x06	Baud	1200	2400	4800	9600	Code	0x07	0x08	0x09	0x0A	Baud	19200	38400	57600	115200	R/W
Code	0x03	0x04	0x05	0x06																		
Baud	1200	2400	4800	9600																		
Code	0x07	0x08	0x09	0x0A																		
Baud	19200	38400	57600	115200																		
40488	RS-485 response delay time in ms, valid range, 0 to 30	R/W																				
40489	RS-485 host watchdog timeout value, 0 to 255, in 0.1s	R/W																				
40492	RS-485 host watchdog timeout count, write 0 to clear	R/W																				
40497	<p>Beep on alarm,</p> <p>0: disable,</p> <p>1 to 250: beep on alarm time in seconds,</p> <p>251: beep on alarm continuously</p>	R/W																				
30513 ~ 30519 40513 ~ 40519	<p>High latched analog input value of channel 0 to 6</p> <p>channel 0: CO₂ in 1ppm,</p> <p>channel 1: PM2.5 in 1ug/m³,</p> <p>channel 2: relative humidity in 0.01%,</p> <p>channel 3: temperature in 0.01°C,</p> <p>channel 4: temperature in 0.01°F,</p> <p>channel 5: dew point temperature in 0.01°C,</p> <p>channel 6: dew point temperature in 0.01°F</p>	R																				

Address	Description	Attribute
30545 ~ 30551 40545 ~ 40551	Low latched analog input value of channel 0 to 6 channel 0: CO ₂ in 1ppm, channel 1: PM2.5 in 1ug/m ³ , channel 2: relative humidity in 0.01%, channel 3: temperature in 0.01°C, channel 4: temperature in 0.01°F, channel 5: dew point temperature in 0.01°C, channel 6: dew point temperature in 0.01°F	R
30556 40556	Module reset status, 1: power-on, 2: watchdog, 3: software reset command Only for Modbus TCP protocol	R
40558	Ethernet host watchdog timeout value, 5 to 65535, in second, 0 to disable. Only for Modbus TCP protocol	R/W
30559 40559	Ethernet host watchdog timeout count. Only for Modbus TCP protocol	R
30560 40560	Module name, 0x0213 Only for Modbus TCP protocol	R
40564	TCP disconnection timeout value, 5 to 65535, in second, 0 to disable. Only for Modbus TCP protocol	R/W
40565	Module reset timeout value, 30 to 65535, in second, 0 to disable. Only for Modbus TCP protocol	R/W
40865	RTC year, 2000 to 2159	R/W
40866	RTC month, 1 to 12	R/W
40867	RTC date, 1 to 31	R/W
40868	RTC hour, 0 to 23	R/W
40869	RTC minute, 0 to 59	R/W
40870	RTC second, 0 to 59	R/W
40871	Total number of log records, low word	R
40872	Total number of log records, high word	R
40873	The starting record to read log data, low word	R/W
40874	The starting record to read log data, high word	R/W
40875	The status of the data logging, 0: stopped, 1: running	R
40876	The data logger command, 0: stop, 1: run, 2: run in period mode	R/W
40877	Continue writing when data logger is full, 0: no, 1: yes	R/W
40878	Hour of the data logger sampling period, 0 to 24	R/W

Address	Description	Attribute
40879	Minute of the data logger sampling period, 0 to 59	R/W
40880	Second of the data logger sampling period, 0 to 59	R/W
40881	Starting year when logging in period mode, 2000 to 2159	R/W
40882	Starting month when logging in period mode, 1 to 12	R/W
40883	Starting date when logging in period mode, 1 to 31	R/W
40884	Starting hour when logging in period mode, 0 to 23	R/W
40885	Starting minute when logging in period mode, 0 to 59	R/W
40886	Starting second when logging in period mode, 0 to 59	R/W
40887	Ending year when logging in period mode, 2000 to 2159	R/W
40888	Ending month when logging in period mode, 1 to 12	R/W
40889	Ending date when logging in period mode, 1 to 31	R/W
40890	Ending hour when logging in period mode, 0 to 23	R/W
40891	Ending minute when logging in period mode, 0 to 59	R/W
40892	Ending second when logging in period mode, 0 to 59	R/W
40929	The first fan off period in a day, beginning hour, 0 to 23	R/W
40930	The first fan off period in a day, beginning minute, 0 to 59	R/W
40931	The first fan off period in a day, ending hour, 0 to 23	R/W
40932	The first fan off period in a day, ending minute, 0 to 59	R/W
40933 ~ 40936	The second fan off period in a day	R/W
40937 ~ 40940	The third fan off period in a day	R/W
40941 ~ 90944	The fourth fan off period in a day	R/W
40945 ~ 40948	The fifth fan off period in a day	R/W
40949 ~ 40952	The sixth fan off period in a day	R/W
00001	Digital output value of channel 0	R/W
00129	Safe value of digital output channel 0	R/W
00161	Power on value of digital output channel 0	R/W
00227	Write 1 to reload default TCP settings Only for Modbus TCP protocol	W
00234	Write 1 to reboot module Only for Modbus TCP protocol	W
00257	RS-485 Protocol, 0: DCON, 1: Modbus RTU	R/W

Address	Description	Attribute
00260	Modbus RTU host watchdog mode 0: same as I-7000 1: can use AO and DO command to clear host watchdog timeout status Only for Modbus RTU protocol	R/W
00261	RS-485 host watchdog mode, 1: enable, 0: disable.	R/W
00262	Write 1 to play notification sound Only for CL-212-E	W
00270	Host watch dog timeout status, write 1 to clear host watch dog timeout status	R/W
00273	Reset status, 1: first read after powered on, 0: not the first read after powered on	R
00279	Fan control, 0: off, 1: on	R/W
00280	Write 1 to clear all high latched analog input values	W
00281	Write 1 to clear all low latched analog input values	W
00291 ~ 00295	Low alarm status of channel 2 to 6. Write 1 to clear low latched alarm. channel 2: relative humidity in 0.01%, channel 3: temperature in 0.01°C, channel 4: temperature in 0.01°F, channel 5: dew point temperature in 0.01°C, channel 6: dew point temperature in 0.01°F	R/W
00305 ~ 00311	High alarm status of channel 0 to 6. Write 1 to clear high latched alarm. channel 0: CO ₂ in 1ppm, channel 1: PM2.5 in 1ug/m ³ , channel 2: relative humidity in 0.01%, channel 3: temperature in 0.01°C, channel 4: temperature in 0.01°F, channel 5: dew point temperature in 0.01°C, channel 6: dew point temperature in 0.01°F	R/W

Address	Description	Attribute
00321 ~ 00327	Enable/disable alarm of channel 0 to 6, write 0 to disable alarm ; write 1 to enable alarm. channel 0: CO ₂ , channel 1: PM2.5 in 1 ug/m ³ channel 2: relative humidity in 0.01%, channel 3: temperature in 0.01°C, channel 4: temperature in 0.01°F, channel 5: dew point temperature in 0.01°C, channel 6: dew point temperature in 0.01°F	R/W
00337 ~ 00343	Alarm type, momentary or latched, of channel 0 to 6, write 0 to enable momentary alarm mode; write 1 to enable latched alarm mode. channel 0: CO ₂ in 1ppm, channel 1: PM2.5 in 1ug/m ³ , channel 2: relative humidity in 0.01%, channel 3: temperature in 0.01°C, channel 4: temperature in 0.01°F, channel 5: dew point temperature in 0.01°C, channel 6: dew point temperature in 0.01°F	R/W
00385 ~ 00391	Write 1 to clear high latched analog input value of channel 0 to 6, channel 0: CO ₂ in 1ppm, channel 1: PM2.5 in 1ug/m ³ , channel 2: relative humidity in 0.01%, channel 3: temperature in 0.01°C, channel 4: temperature in 0.01°F, channel 5: dew point temperature in 0.01°C, channel 6: dew point temperature in 0.01°F	W
00417 ~ 00423	Write 1 to clear low latched analog input value of channel 0 to 6 channel 0: CO ₂ in 1ppm, channel 1: PM2.5 in 1ug/m ³ , channel 2: relative humidity in 0.01%, channel 3: temperature in 0.01°C, channel 4: temperature in 0.01°F, channel 5: dew point temperature in 0.01°C, channel 6: dew point temperature in 0.01°F	W
00449 ~ 00455	Enable/disable beep on alarm for channel 0 to 6	R/W

C-12. CL-213 / CL-213-E Modbus Address Mappings (Base 1)

Address	Description	Attribute
30001 ~ 30008 40001 ~ 40008	Analog input value of channel 0 to 7. channel 0: CO in 1ppm, channel 1: CO ₂ in 1ppm, channel 2: PM2.5 in 1ug/m ³ , channel 3: relative humidity in 0.01%, channel 4: temperature in 0.01°C, channel 5:temperature in 0.01°F, channel 6: dew point temperature in 0.01°C, channel 7: dew point temperature in 0.01°F	R
40225 ~ 40232	High alarm limit of channel 0 to 7, channel 0: CO in 1ppm, channel 1: CO ₂ in 1ppm, channel 2: PM2.5 in 1ug/m ³ , channel 3: relative humidity in 0.01%, channel 4: temperature in 0.01°C, channel 5:temperature in 0.01°F, channel 6: dew point temperature in 0.01°C, channel 7: dew point temperature in 0.01°F	R/W
40236 ~ 40240	Low alarm limit of channel 3 to 7, channel 3: relative humidity in 0.01%, channel 4: temperature in 0.01°C, channel 5: temperature in 0.01°F, channel 6: dew point temperature in 0.01°C, channel 7: dew point temperature in 0.01°F	R/W
40272	Modbus NetID Only for Modbus TCP protocol	R/W
30301 40301	Number of the digital input channels Only for Modbus TCP protocol	R
30311 40311	Number of the digital output channels Only for Modbus TCP protocol	R
30321 40321	Number of the analog input channels Only for Modbus TCP protocol	R
30331 40331	Number of the analog output channels Only for Modbus TCP protocol	R

Address	Description	Attribute																				
30352	Firmware version in hex format	R																				
40352	Only for Modbus TCP protocol																					
40449	CO offset in 1 ppm	R/W																				
40450	CO ₂ offset in 1 ppm	R/W																				
40451	PM2.5 offset in 1 ug/m ³	R/W																				
40452	Relative humidity offset in 0.01%	R/W																				
40453	Temperature offset in 0.01°C	R/W																				
40481	Firmware version (low word)	R																				
40482	Firmware version (high word)	R																				
40483	Module name (low word), 0x0213	R																				
40484	Module name (high word), 0x434C	R																				
40485	RS-485 module address, 1 to 247	R/W																				
40486	RS-485 baud rate and parity settings Bits 5:0 Baud rate, valid range: 3 ~ 10 <table border="1" style="margin-left: 40px;"> <tbody> <tr> <td>Code</td> <td>0x03</td> <td>0x04</td> <td>0x05</td> <td>0x06</td> </tr> <tr> <td>Baud</td> <td>1200</td> <td>2400</td> <td>4800</td> <td>9600</td> </tr> <tr> <td>Code</td> <td>0x07</td> <td>0x08</td> <td>0x09</td> <td>0x0A</td> </tr> <tr> <td>Baud</td> <td>19200</td> <td>38400</td> <td>57600</td> <td>115200</td> </tr> </tbody> </table> Bits 7:6 00: no parity, 1 stop bit (N,8,1) 01: no parity, 2 stop bits (N,8,2) 10: even parity, 1 stop bit (E,8,1) 11: odd parity, 1 stop bit (O,8,1)	Code	0x03	0x04	0x05	0x06	Baud	1200	2400	4800	9600	Code	0x07	0x08	0x09	0x0A	Baud	19200	38400	57600	115200	R/W
Code	0x03	0x04	0x05	0x06																		
Baud	1200	2400	4800	9600																		
Code	0x07	0x08	0x09	0x0A																		
Baud	19200	38400	57600	115200																		
40488	RS-485 response delay time in ms, valid range, 0 to 30	R/W																				
40489	RS-485 host watchdog timeout value, 0 to 255, in 0.1s	R/W																				
40492	RS-485 host watchdog timeout count, write 0 to clear	R/W																				
40496	Automatic baseline correction for CO ₂ measurement, 0: disable, 1:enable	R/W																				
40497	Beep on alarm, 0: disable, 1 to 250: beep on alarm time in seconds, 251: beep on alarm continuously	R/W																				

Address	Description	Attribute
30513 ~ 30520 40513 ~ 40520	High latched analog input value of channel 0 to 7 channel 0: CO in 1ppm, channel 1: CO ₂ in 1ppm, channel 2: PM2.5 in 1ug/m ³ , channel 3: relative humidity in 0.01%, channel 4: temperature in 0.01°C, channel 5: temperature in 0.01°F, channel 6: dew point temperature in 0.01°C, channel 7: dew point temperature in 0.01°F	R
30545 ~ 30552 40545 ~ 40552	Low latched analog input value of channel 0 to 7 channel 0: CO in 1ppm, channel 1: CO ₂ in 1ppm, channel 2: PM2.5 in 1ug/m ³ , channel 3: relative humidity in 0.01%, channel 4: temperature in 0.01°C, channel 5: temperature in 0.01°F, channel 6: dew point temperature in 0.01°C, channel 7: dew point temperature in 0.01°F	R
30556 40556	Module reset status, 1: power-on, 2: watchdog, 3: software reset command Only for Modbus TCP protocol	R
40558	Ethernet host watchdog timeout value, 5 to 65535, in second, 0 to disable. Only for Modbus TCP protocol	R/W
30559 40559	Ethernet host watchdog timeout count. Only for Modbus TCP protocol	R
30560 40560	Module name, 0x0213 Only for Modbus TCP protocol	R
40564	TCP disconnection timeout value, 5 to 65535, in second, 0 to disable. Only for Modbus TCP protocol	R/W
40565	Module reset timeout value, 30 to 65535, in second, 0 to disable. Only for Modbus TCP protocol	R/W
40865	RTC year, 2000 to 2159	R/W
40866	RTC month, 1 to 12	R/W
40867	RTC date, 1 to 31	R/W
40868	RTC hour, 0 to 23	R/W

Address	Description	Attribute
40869	RTC minute, 0 to 59	R/W
40870	RTC second, 0 to 59	R/W
40871	Total number of log records, low word	R
40872	Total number of log records, high word	R
40873	The starting record to read log data, low word	R/W
40874	The starting record to read log data, high word	R/W
40875	The status of the data logging, 0: stopped, 1: running	R
40876	The data logger command, 0: stop, 1: run, 2: run in period mode	R/W
40877	Continue writing when data logger is full, 0: no, 1: yes	R/W
40878	Hour of the data logger sampling period, 0 to 24	R/W
40879	Minute of the data logger sampling period, 0 to 59	R/W
40880	Second of the data logger sampling period, 0 to 59	R/W
40881	Starting year when logging in period mode, 2000 to 2159	R/W
40882	Starting month when logging in period mode, 1 to 12	R/W
40883	Starting date when logging in period mode, 1 to 31	R/W
40884	Starting hour when logging in period mode, 0 to 23	R/W
40885	Starting minute when logging in period mode, 0 to 59	R/W
40886	Starting second when logging in period mode, 0 to 59	R/W
40887	Ending year when logging in period mode, 2000 to 2159	R/W
40888	Ending month when logging in period mode, 1 to 12	R/W
40889	Ending date when logging in period mode, 1 to 31	R/W
40890	Ending hour when logging in period mode, 0 to 23	R/W
40891	Ending minute when logging in period mode, 0 to 59	R/W
40892	Ending second when logging in period mode, 0 to 59	R/W
40929	The first fan off period in a day, beginning hour, 0 to 23	R/W
40930	The first fan off period in a day, beginning minute, 0 to 59	R/W
40931	The first fan off period in a day, ending hour, 0 to 23	R/W
40932	The first fan off period in a day, ending minute, 0 to 59	R/W
40933 ~ 40936	The second fan off period in a day	R/W
40937 ~ 40940	The third fan off period in a day	R/W
40941 ~ 90944	The fourth fan off period in a day	R/W
40945 ~ 40948	The fifth fan off period in a day	R/W

Address	Description	Attribute
40949 ~ 40952	The sixth fan off period in a day	R/W
00001	Digital output value of channel 0	R/W
00129	Safe value of digital output channel 0	R/W
00161	Power on value of digital output channel 0	R/W
00227	Write 1 to reload default TCP settings Only for Modbus TCP protocol	W
00234	Write 1 to reboot module Only for Modbus TCP protocol	W
00257	RS-485 Protocol, 0: DCON, 1: Modbus RTU	R/W
00260	Modbus RTU host watchdog mode 0: same as I-7000 1: can use AO and DO command to clear host watchdog timeout status	R/W
00261	RS-485 host watchdog mode, 1: enable, 0: disable.	R/W
00262	Write 1 to play notification sound Only for CL-213-E	W
00270	Host watch dog timeout status, write 1 to clear host watch dog timeout status	R/W
00273	Reset status, 1: first read after powered on, 0: not the first read after powered on	R
00279	Fan control, 0: off, 1: on	R/W
00280	Write 1 to clear all high latched analog input values	W
00281	Write 1 to clear all low latched analog input values	W
00292 ~ 00296	Low alarm status of channel 3 to 7. Write 1 to clear low latched alarm. channel 3: relative humidity in 0.01%, channel 4: temperature in 0.01°C, channel 5: temperature in 0.01°F, channel 6: dew point temperature in 0.01°C, channel 7: dew point temperature in 0.01°F	R/W

Address	Description	Attribute
00305 ~ 00312	<p>High alarm status of channel 0 to 7. Write 1 to clear high latched alarm.</p> <p>channel 0: CO in 1ppm, channel 1: CO₂ in 1ppm, channel 2: PM2.5 in 1ug/m³, channel 3: relative humidity in 0.01%, channel 4: temperature in 0.01°C, channel 5: temperature in 0.01°F, channel 6: dew point temperature in 0.01°C, channel 7: dew point temperature in 0.01°F</p>	R/W
00321 ~ 00328	<p>Enable/disable alarm of channel 0 to 7, write 0 to disable alarm ; write 1 to enable alarm.</p> <p>channel 0: CO in 1ppm, channel 1: CO₂ in 1ppm, channel 2: PM2.5 in 1ug/m³ channel 3: relative humidity in 0.01%, channel 4: temperature in 0.01°C, channel 5: temperature in 0.01°F, channel 6: dew point temperature in 0.01°C, channel 7: dew point temperature in 0.01°F</p>	R/W
00337 ~ 00344	<p>Alarm type, momentary or latched, of channel 0 to 7, write 0 to enable momentary alarm mode; write 1 to enable latched alarm mode.</p> <p>channel 0: CO in 1ppm, channel 1: CO₂ in 1ppm, channel 2: PM2.5 in 1ug/m³, channel 3: relative humidity in 0.01%, channel 4: temperature in 0.01°C, channel 5: temperature in 0.01°F, channel 6: dew point temperature in 0.01°C, channel 7: dew point temperature in 0.01°F</p>	R/W

Address	Description	Attribute
00385 ~ 00392	Write 1 to clear high latched analog input value of channel 0 to 7, channel 0: CO in 1ppm, channel 1: CO ₂ in 1ppm, channel 2: PM2.5 in 1ug/m ³ , channel 3: relative humidity in 0.01%, channel 4: temperature in 0.01°C, channel 5: temperature in 0.01°F, channel 6: dew point temperature in 0.01°C, channel 7: dew point temperature in 0.01°F	W
00417 ~ 00424	Write 1 to clear low latched analog input value of channel 0 to 7 channel 0: CO in 1ppm, channel 1: CO ₂ in 1ppm, channel 2: PM2.5 in 1ug/m ³ , channel 3: relative humidity in 0.01%, channel 4: temperature in 0.01°C, channel 5: temperature in 0.01°F, channel 6: dew point temperature in 0.01°C, channel 7: dew point temperature in 0.01°F	W
00449 ~ 00456	Enable/disable beep on alarm for channel 0 to 7	R/W

C-13. CL-250-E Modbus Address Mappings (Base 1)

Address	Description	Attribute
30001 ~ 30006 40001 ~ 40006	Analog input value of channel 0 to 5. channel 0: O ₂ in 0.01%, channel 1: relative humidity in 0.01%, channel 2: temperature in 0.01°C, channel 3: temperature in 0.01°F, channel 4: dew point temperature in 0.01°C, channel 5: dew point temperature in 0.01°F	R
40226 ~ 40230	High alarm limit of channel 1 to 5, channel 1: relative humidity in 0.01%, channel 2: temperature in 0.01°C, channel 3: temperature in 0.01°F, channel 4: dew point temperature in 0.01°C, channel 5: dew point temperature in 0.01°F	R/W
40233 ~ 40238	Low alarm limit of channel 0 to 5, channel 0: O ₂ in 0.01%, channel 1: relative humidity in 0.01%, channel 2: temperature in 0.01°C, channel 3: temperature in 0.01°F, channel 4: dew point temperature in 0.01°C, channel 5: dew point temperature in 0.01°F	R/W
40272	Modbus NetID Only for Modbus TCP protocol	R/W
30301 40301	Number of the digital input channels Only for Modbus TCP protocol	R
30311 40311	Number of the digital output channels Only for Modbus TCP protocol	R
30321 40321	Number of the analog input channels Only for Modbus TCP protocol	R
30331 40331	Number of the analog output channels Only for Modbus TCP protocol	R
30352 40352	Firmware version in hex format Only for Modbus TCP protocol	R
40449	O ₂ offset in 0.01 %	R/W
40450	Relative humidity offset in 0.01%	R/W
40451	Temperature offset in 0.01°C	R/W
40481	Firmware version (low word)	R
40482	Firmware version (high word)	R
40483	Module name (low word), 0x020B	R
40484	Module name (high word), 0x434C	R
40485	RS-485 module address, 1 to 247 Only for Modbus RTU protocol	R/W

Address	Description	Attribute
40486	RS-485 baud rate and parity settings Bits 5:0 Baud rate, valid range: 3 ~ 10 Bits 7:6 00: no parity, 1 stop bit 01: no parity, 2 stop bit 10: even parity, 1 stop bit 11: odd parity , 1 stop bit Only for Modbus RTU protocol	R/W
40488	RS-485 response delay time in ms, valid range, 0 ~ 30 Only for Modbus RTU protocol	R/W
40489	RS-485 host watchdog timeout value, 0 ~ 255, in 0.1s Only for Modbus RTU protocol	R/W
40492	RS-485 host watchdog timeout count, write 0 to clear Only for Modbus RTU protocol	R/W
40497	Beep on alarm, 0: disable, 1 to 250: beep on alarm time in seconds, 251: beep on alarm continuously	R/W
30513 ~ 30518 40513 ~ 40518	High latched analog input value of channel 0 to 5	R
30545 ~ 30550 40545 ~ 40550	Low latched analog input value of channel 0 to 5	R
30556 40556	Module reset status, 1: power-on, 2: watchdog, 3: software reset command Only for Modbus TCP protocol	R
40558	Ethernet host watchdog timeout value, 5 to 65535, in second, 0 to disable. Only for Modbus TCP protocol	R/W
30559 40559	Ethernet host watchdog timeout count. Only for Modbus TCP protocol	R
30560 40560	Module name, 0x020B Only for Modbus TCP protocol	R
40564	TCP disconnection timeout value, 5 to 65535, in second, 0 to disable. Only for Modbus TCP protocol	R/W

Address	Description	Attribute
40565	Module reset timeout value, 30 to 65535, in second, 0 to disable. Only for Modbus TCP protocol	R/W
40865	RTC year, 2000 to 2159	R/W
40866	RTC month, 1 to 12	R/W
40867	RTC date, 1 to 31	R/W
40868	RTC hour, 0 to 23	R/W
40869	RTC minute, 0 to 59	R/W
40870	RTC second, 0 to 59	R/W
40871	Total number of log records, low word	R
40872	Total number of log records, high word	R
40873	The starting record to read log data, low word	R/W
40874	The starting record to read log data, high word	R/W
40875	The status of the data logging, 0: stopped, 1: running	R
40876	The data logger command, 0: stop, 1: run, 2: run in period mode	R/W
40877	Continue writing when data logger is full, 0: no, 1: yes	R/W
40878	Hour of the data logger sampling period, 0 ~ 24	R/W
40879	Minute of the data logger sampling period, 0 ~ 59	R/W
40880	Second of the data logger sampling period, 0 ~ 59	R/W
40881	Starting year when logging in period mode, 2000 ~ 2159	R/W
40882	Starting month when logging in period mode, 1 ~ 12	R/W
40883	Starting date when logging in period mode, 1 ~ 31	R/W
40884	Starting hour when logging in period mode, 0 ~ 23	R/W
40885	Starting minute when logging in period mode, 0 ~ 59	R/W
40886	Starting second when logging in period mode, 0 ~ 59	R/W
40887	Ending year when logging in period mode, 2000 ~ 2159	R/W
40888	Ending month when logging in period mode, 1 ~ 12	R/W
40889	Ending date when logging in period mode, 1 ~ 31	R/W
40890	Ending hour when logging in period mode, 0 ~ 23	R/W
40891	Ending minute when logging in period mode, 0 ~ 59	R/W
40892	Ending second when logging in period mode, 0 ~ 59	R/W
00001	Digital output value of channel 0	R/W
00129	Safe value of digital output channel 0	R/W
00161	Power on value of digital output channel 0	R/W
00227	Write 1 to reload default TCP settings Only for Modbus TCP protocol	W

Address	Description	Attribute
00234	Write 1 to reboot module Only for Modbus TCP protocol	W
00257	RS-485 Protocol, 0: DCON, 1: Modbus RTU Only for Modbus RTU protocol	R/W
00260	Modbus RTU host watchdog mode 0: same as I-7000 1: can use AO and DO command to clear host watchdog timeout status Only for Modbus RTU protocol	R/W
00261	RS-485 host watchdog mode, 1: enable, 0: disable. Only for Modbus RTU protocol	R/W
00262	Write 1 to play notification sound	W
00270	Host watch dog timeout status, write 1 to clear host watch dog timeout status Only for Modbus RTU protocol	R/W
00273	Reset status, 1: first read after powered on, 0: not the first read after powered on Only for Modbus RTU protocol	R
00280	Write 1 to clear all high latched analog input values	W
00281	Write 1 to clear all low latched analog input values	W
00289 ~ 00294	Low alarm status of channel 0 to 5. Write 1 to clear low latched alarm.	R/W
00306 ~ 00310	High alarm status of channel 1 to 5. Write 1 to clear high latched alarm.	R/W
00321 ~ 00326	Enable/disable alarm of channel 0 to 5	R/W
00337 ~ 00342	Alarm type, momentary or latched, of channel 0 to 5	R/W
00385 ~ 00390	Write 1 to clear high latched analog input value of channel 0 to 5	W
00417 ~ 00422	Write 1 to clear low latched analog input value of channel 0 to 5	W
00449 ~ 00454	Enable/disable beep on alarm for channel 0 to 5	R/W

C-13. Wi-Fi Setting Modbus Address Mappings (Base 1)

Address	Description	Attribute
40642	Wi-Fi mode, 0 for station mode and 2 for AP mode	R/W
40643	Wi-Fi security type, 0 for open, 1 for WEP and 2 for WPA/WPA2	R/W
40644 ~ 40650	WEP password Byte 0: password length Byte 1 ~ 13: password	R/W
40651 ~ 40682	WPA/WPA2 password Byte 0: password length Byte 1 ~ 63: password	R/W
40683	DHCP server in AP mode, 0 for off and 1 for on	R/W
40684 ~ 40685	Start IP address of the allocated IP by the DHCP server in AP mode	R/W
40687	IP address type in station mode, 0 for static type, 1 for DHCP	R/W
40688 ~ 40689	Device IP address	R/W
40690 ~ 40691	Device subnet mask	R/W
40692 ~ 40693	Device gateway	R/W
40694 ~ 40709	SSID	R/W
40710	Wi-Fi channel for AP mode, 1 to 11	R/W
40711	Modbus TCP port for Wi-Fi	R/W
40715	Write 1 to let the new settings take effect	W
40716 ~ 40718	Wi-Fi module MAC address	R
40719	Firmware version of the Wi-Fi module	R
40720	Wi-Fi module status High byte 0: not configured 1: not connected 2: connected 3: reconnecting Low byte 0: not connected 1: high signal strength 2: medium signal strength 3: low signal strength	R

Revision History

Revision	Date	Description
1.0.0	2017/Aug.	First released
1.1.0	2018/Feb.	-Added CL-201-E/CL-202-E/CL-203-E information -Modified the path for software and manual in the CD and on the website.
1.2.0	2019/Apr.	-Added CL-211/CL-212/CL-213/CL-204-E/CL-205-E/CL-206-E/CL-207-E/CL-208-E information. -Added information page 32~34, 50~52, 64~69.
1.3.0	2021/Mar	-Added CL-250-E information