



iWSN-750-Series

iWSN Series Expansion Module

Introduction

In order to upgrade the flexibility and expansibility of iWSN sensing module, the iWSN expansion module is developed to connect to the iWSN sensing module. By means of iWSN expansion modules, the iWSN sensing module can offer more current and temperature measurement channels. The iWSN expansion module is energized by iWSN sensing module so that there is no external power supply needed. For convenient setting up and maintaining the application, the iWSN expansion module provide removable screwed terminal block, wall-mount mechanism and magnet adsorption for installation, and also allows connecting different measurement range of CTs to fit various applications. More kinds of IO interface will be designed to rich the iWSN functionalities and unleash the power of iWSN sensing modules.

System Specifications

Model	iWSN-750P	iWSN-757P	
CT			
Split-core CT Channel Number	5		
Split-core CT Type	Φ16mm (100A), Φ24mm (200A), or Φ36mm (400A); 8 m wire		
Input Voltage	Maximum 500VAC, 60 Hz		
Accuracy	±3% or ±0.3A		
Thermistor			
Channel Number	0	7	
Measurement Temperature	0 °C to +80 °C		
Accuracy	±2 °C		
Installation	Wall-mount or magnet adsorption		
Power			
Input Type	iWSN sensing module provides power through the audio line.		
Power Consumption (Included iWSN-1110X) (*1)	1-sec Tx Duty	20 A	21 A
	10-sec Tx Duty	12 A	13 A
	30-sec Tx Duty	11 A	12 A
	60-sec Tx Duty	11 A	12 A

Features

- Supports multi-channel IO expansion
- Powered by iWSN sensing module
- Removable screwed terminal block for easy maintenance
- Offers wall-mount mechanism and magnet for installation
- Allows connecting different measurement range of CTs in one expansion module



Applications

1. iWSN sensor and iWSN-750P connection diagram

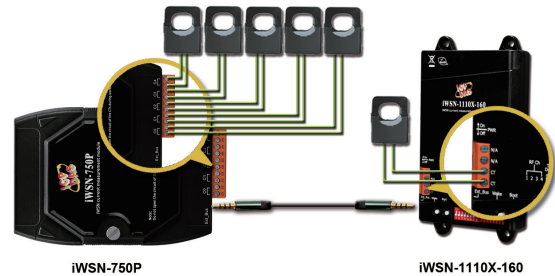

2. iWSN sensor and iWSN-757P connection diagram

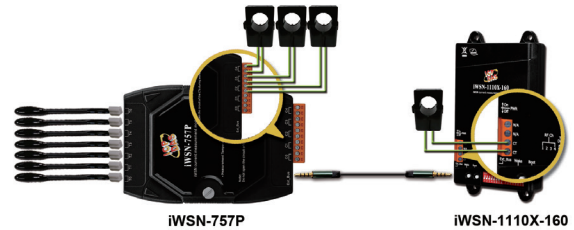

Model	iWSN-750P	iWSN-757P
Mechanical		
Flammability	Fire Retardant Materials	
Dimensions (W x L x H)	72 mm x 115 mm x 35 mm	
Installation	DIN-rail or magnet adsorption	
Environment		
Operating Temperature	0°C to +45°C	
Storage Temperature	-20 °C to +50 °C	
Relative Humidity	10 ~ 90% RH, Non-condensing	
Certification	CE	

(*1) The minimum current required in the AC cable for balancing module's power charging and power consumption.

Appearance

iWSN-750P

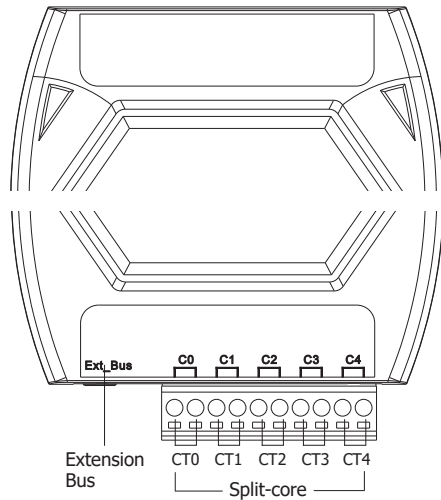

iWSN-757P

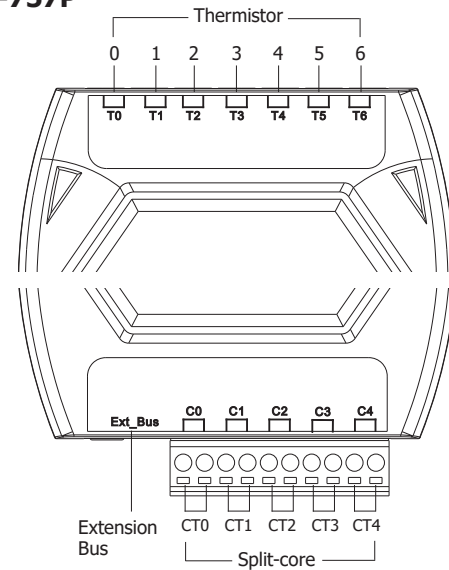

Dimensions (Units: mm)

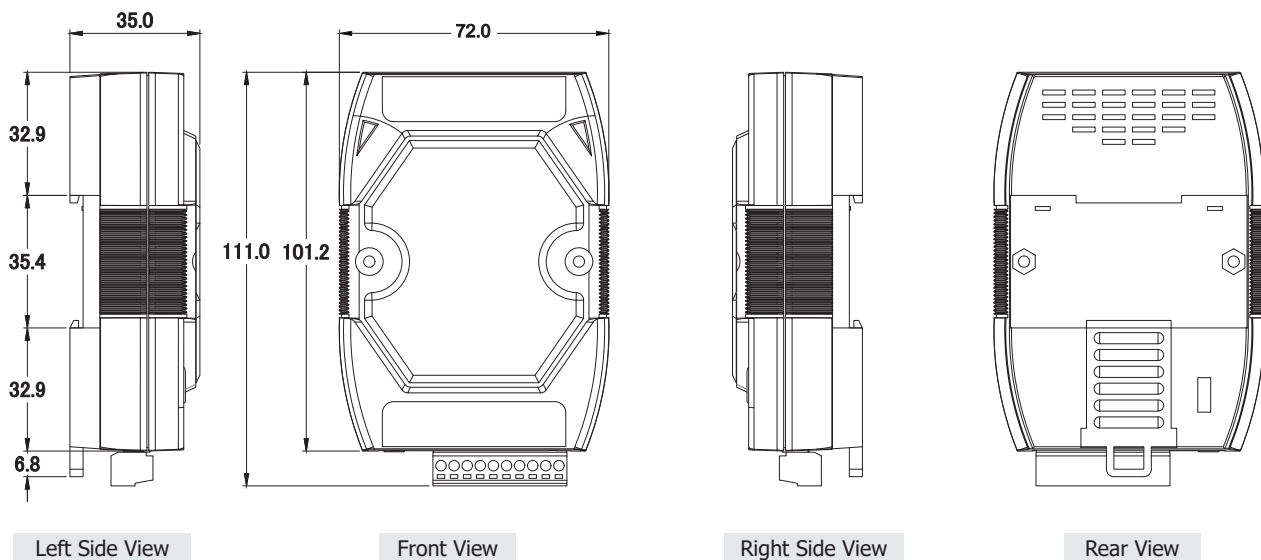

Ordering Information

iWSN-750P CR	iWSN extension module with five current measurement channels. (Without CTs)(RoHS)
iWSN-757P CR	iWSN extension module with five current measurement channels and seven thermistor channels. (Without CTs and thermistors)(RoHS)
Important Note:	
1.The iWSN series expansion module needs to be used with iWSN sensing module. Users can refer to the iWSN-1110X or iWSN-1120X series module according to their needs.	
2.The iWSN sensing module measurement information must be collected through the iWSN receiver. Users can refer to the iWSN-2200 or iWSN-2200-E module according to their needs	

Accessories

iWSN-1110X Series	iWSN current measurement module (RoHS); current measurement channel x 1, expansion interface x 1 (optional 100A/200A/400A CT)
iWSN-1120X Series	iWSN current measurement module (RoHS); current measurement channel(for RCT) x 1, expansion interface x 1, 1000A RCT x 1, with 200A/400A CT x 1 (charge only)
iWSN-2200	iWSN data concentrator with RS-232/RS-485 serial port (RoHS)
iWSN-2200-E	iWSN data concentrator with Ethernet port (RoHS)
CA-SCT16I-100A-L080	8 m 100A Φ 16mm Split-Core CT
CA-TM-MS-050	5 m Metal plug thermistor