



# Industrial Remote I/O

//////  
**Ethernet / RS-485 / PROFIBUS / Expansion / Wireless**  
**Series products introduction**  
//////

# PROFIBUS

## I/O Module Introduction

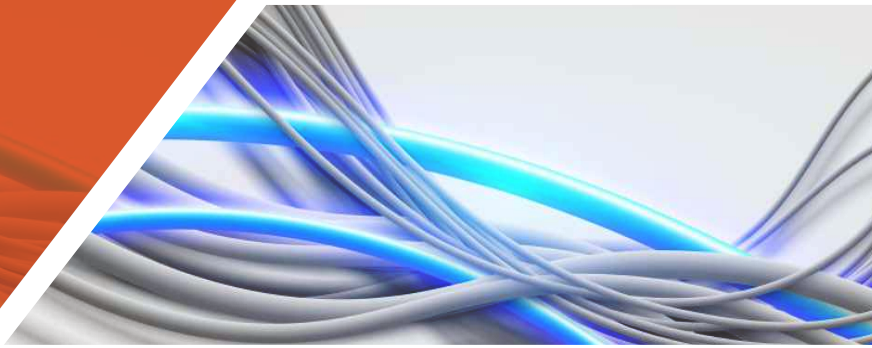

### PROFIBUS



- Wide coverage use in industrial machine and devices
- Multi-master system



PROFI-5000 series



PROFI-8000 series

### CAN BUS



- Heartbeat messaging
- Safety & arbitration
- Auto response of input data
- CANopen digital I/O pair-connection



CAN-2000 series



CAN-8000 series

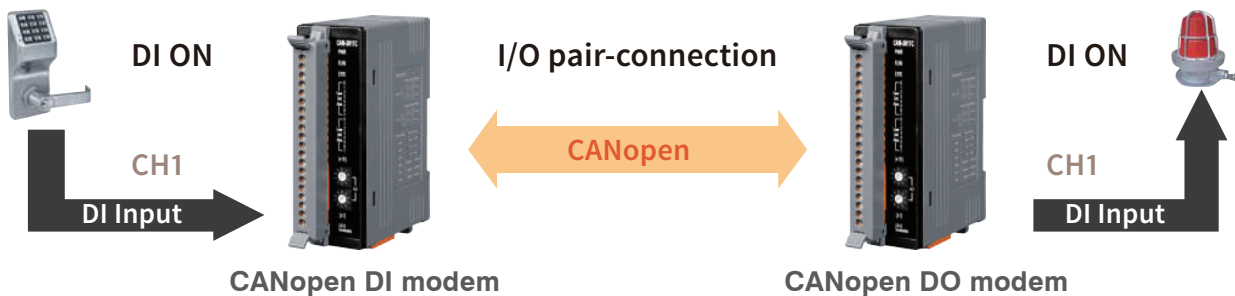
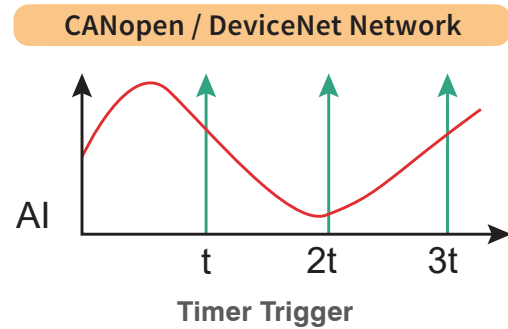
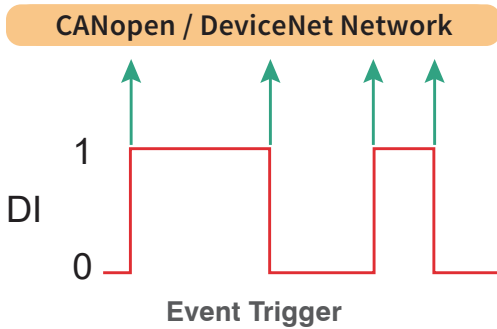

Application : Hydropower, Automated Industry...



# Expansion unit introduction

## PROFIBUS I CAN BUS



### :: CANBUS Remote I/O Units

- ▶ CANopen DS 301 Ver 4.02 / DS 401 Ver 2.1 Specification

Model Name	CANopen Embedded Device
CAN-8123-G	1 I/O Expansion slot, support I-87K module and I-8K module
CAN-8223-G	2 I/O Expansion slots, support I-87K module and I-8K module
CAN-8423-G	4 I/O Expansion slots, support I-87K module and I-8K module
CAN-8823-G	8 I/O Expansion slots, support I-87K module and I-8K module

- ▶ DeviceNet Volume I Ver 2.0, Volume II Ver2.0

Model Name	DeviceNet Embedded Device
CAN-8124-G	1 I/O Expansion slot, support I-87K module and I-8K module
CAN-8224-G	2 I/O Expansion slots, support I-87K module and I-8K module
CAN-8424-G	4 I/O Expansion slots, support I-87K module and I-8K module
CAN-8824-G	8 I/O Expansion slots, support I-87K module and I-8K module

### :: PROFIBUS Remote I/O Units



PROFI-8155



PROFI-8255



PROFI-8455



PROFI-8555

- Protocol & hierarchy: DP-V0 & DP-V1 slave
- Detect transmission rate automatically (Max.12 mbps)
- Support device-related & channel-related diagnosis
- Address 0 ~ 126 set by rotary switches or SSA-telegram
- Support hot-swap for I-87K high-profile I/O modules
- 3000 VDC isolation protection on PROFIBUS side
- 1/2/4/8 I/O slots for I-87K and I-8K series I/O modules
- 4 KV ESD protection (contacting for any terminal)
- Operating temperature: -25°C ~ +75°C

Model Name	CR PROFIBUS Remote I/O Unit
PROFI-8155-G	1 Expansion slot (RoHS)
PROFI-8255-G	2 Expansion slots (RoHS)

Model Name	CR PROFIBUS Remote I/O Unit
PROFI-8455-G	4 Expansion slot (RoHS)
PROFI-8855-G	8 Expansion slots (RoHS)

# Expansion unit introduction

## RS-485 | Ethernet

### :: RS-485 Remote I/O Units



#### Communication

- RS-485 industrial multi-drop network
- DCON protocol

#### Fully Software Support

- DCON utility: for configuration
- OPC servers
- EZ data logger
- Various software development toolkits

#### Rugged Industrial Environment

- Power on value & safe value
- Dual watchdog
- -25°C ~ +75°C Operating temperature
- +10 ~ +30 VDC power input
- ESD & surge protection

### :: Ethernet Remote I/O Units

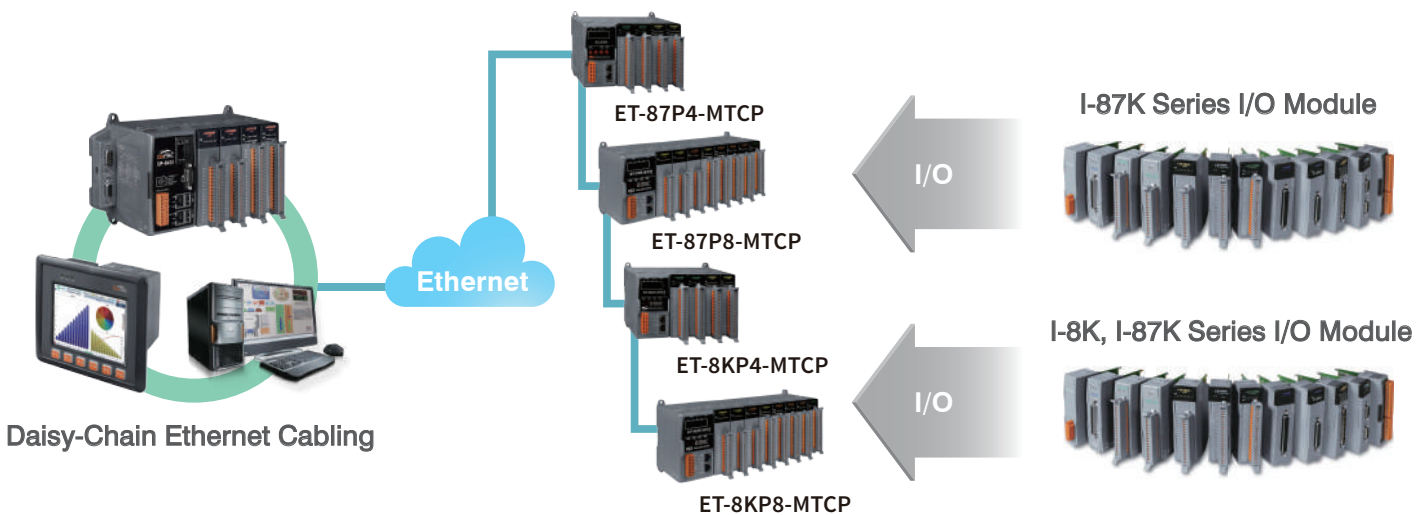





# Wireless



## I/O Module Introduction

### Wi-Fi

-  RTD input
-  Multi-AIO
-  DIO / relay



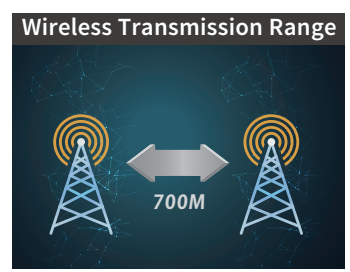
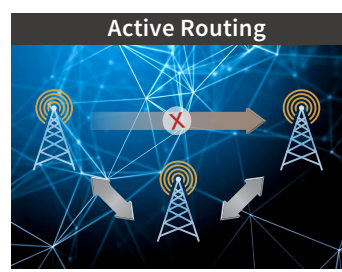

### ZigBee

-  700m distance coverage
-  Fully compliant with 2.4 G
-  Individual channel configuration





### LoRa NB-IoT

-  32 RF channels(864~ 871.5MHz , 915~ 922.5MHz)
-  RF baud rates: 10,000 ~ 250 bps
-  Support RS-232 and RS-485 interfaces



LRA-900

### 

-  Wireless modem / 2.4GHz / RS-232 / RS-485
-  Support half-duplex / full-duplex communication
-  Wireless transmission range up to 700 m



RFU-400 RFU-433

# Ethernet I/O Module Introduction

## EtherNet/IP

- ✓ Open network standard, can work transparently with all the standard ethernet devices
- ✓ Compatible with general communication standards, including OPC, TCP/IP, HTTP, FTP, SNMP, DHCP



## EtherCAT

- ✓ Flexible and easy installation using a daisy chain connection
- ✓ Able to use multiple network topologies such as star, line or ring
- ✓ Industrial design that protects against harmful interference and harsh environments



## BACnet/IP

- ✓ Designed for building automation and control systems
- ✓ Able to use in various application such as heating, ventilating, and air-conditioning control, lighting control, access control, and fire detection systems and their associated equipment



## PROFINET

- ✓ PROFINET conformance class B and RT class 1
- ✓ Able to use PROFINET protocol with any PROFINET controllers
- ✓ Generic GSDML file provided (version 2.25)



## MQTT I/O

- ✓ Flexible and easy installation using a daisy chain connection
- ✓ Supports 3 publish message types for various applications
- ✓ User-defined topic



## WISE I/O

- ✓ Built-in IF-THEN-ELSE control logic engine
- ✓ Supports Modbus TCP/RTU protocol
- ✓ Supports PoE (power over ethernet) function
- ✓ Support counter, timer, Email operations



## OPC UA I/O

- ✓ Wide range product coverage
- ✓ OPC UA server, MQTT client



## Modbus TCP I/O

- ✓ Support for both Modbus TCP and Modbus UDP protocols
- ✓ 2-port ethernet switch for daisy-chain topology
- ✓ Built-in web HMI for configuration
- ✓ Supports I/O pair connection



# RS-485 I/O Module Introduction



Twisted-pair Cabling



1.2 Km Communication Distance



Modbus RTU



3000 VDC Isolation



RS-485 Direction Self-tuner

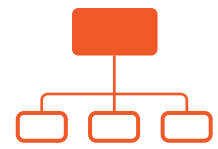

Multi-nodes Up To 256



Dual Watchdog



Overload Voltage/Current Protection

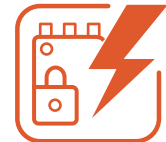

Surge Protection

## tM Series



- Small but powerful

## M-7000 Series



- Multi-spec selection

## M-2000 Series



- Straight din-rail module

## USB Series

- USB bus powered
- Dual watchdog
- Power on value & safe value
- Highly reliable under harsh environment



USB-2000



USB-87Pn



**Intelligent IoT Industrial Vibration Solution**  
2019/Aug.

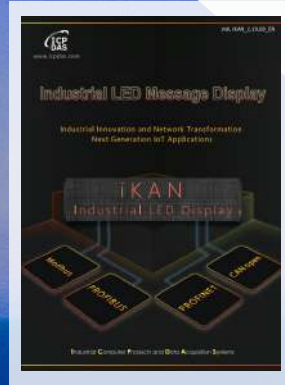

**Industrial LED Message Display**  
2019/Aug.



**IIOT INDUSTRY 4.0**  
2019/Oct.



**Intelligent Auditory IoT Smart Buzzer Solution**  
2020/Feb.



**Temperature Data Logger**  
2020/Feb.



**DL-1000 Series Industrial AirBox**  
2020/Mar.

Local Distributor

