

High-sensitivity Type

Long-range Type

Standard Type

# PIR Series Human Motion Sensor Module



PIR-234 Series



PIR-130 Series



PIR-231 Series



Human Motion Detection



PoE-capable



T&H Sensor



Relay Output



Adjustable Time Delay



Support Various Communication Protocols

# High-sensitivity Type Human Presence Detection

- ▶ Each module of the PIR-234/PIR-234L series contains 4 PIR sensors. Each PIR sensor can be independently configured to turn on/off, providing flexibility in adjusting the detection range and adapting to different layouts of the space.

PIR-234 Series

PIR-234L Series



## Are you facing these issues when using infrared sensors for human presence detection?

- ▶ Lights go out abruptly when you are being focused in a meeting?



- ▶ Or, lights go out suddenly while you are refilling water in an office pantry?

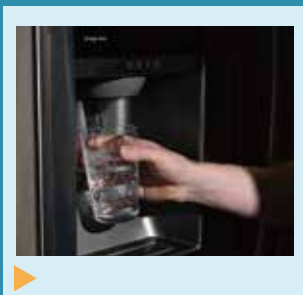

PIR-234/PIR-234L series, the high-sensitivity type, feature 4 built-in PIR sensors in each module. The design greatly enhances the sensitivity of human presence detection, **capable of detecting movement with a diameter as small as 3 cm**. This series is ideal for applications in which human body movement is subtle, preventing unnecessary light deactivation caused by undetected human presence. With a reliable lighting control system, you can concentrate on meetings, work, reading, and other indoor activities.

Meeting Room

Office Pantry

Living Room







# Long-range Type

## Human Motion Detection

- ▶ Have you encountered situations where passive infrared (PIR) sensors failed to detect human motion due to the installation height? PIR-231 series (Long-range Type) features a maximum detection range of 10 meters from the floor, making it suited for spaces with high ceilings, including warehouses, factories, and huge halls.

**PIR-231 Series**

**Stadium**



**Factory**



**Hall with High Ceilings**



**Warehouse**





# Standard Type Human Motion Detection

PIR-130 Series

PIR-230 Series

► PIR-130/PIR-230 series, the standard type, is designed to detect human motion and then activate lights accordingly. Individuals no longer have to fumble around in the dark for a light switch. Besides, the automatic lighting control system achieves energy savings. This series is suitable for various passage applications, including corridors, staircases, and entryways with shoe storage cabinets & benches.



Corridor

Staircase

Locker Room



## Building Automation & Integrated IoT Applications

A combination of PIR and WISE enables lighting that creates different ambiances



PIR-130/230  
Human Motion  
Sensor Module



M-7000  
I/O Module



WISE Series  
Intelligent Edge  
Controller

Install PIR sensors at both ends of a corridor and connect them to the WISE controller. This system enables lighting control through IF-THEN-ELSE logic rules. For example, it can be configured to activate each light sequentially from the nearest to the farthest once a human walking motion is detected.

Human Motion Sensor Module  
PIR-130/230



# Building Automation & Integrated IoT Applications



- ▶ Various Communication Protocols
- ▶ PIR Integrates with Building Monitoring Applications Easily
- ▶ Greatly Ease the Burden on Staff Conducting Inspections

An integration of the PIR series and WISE controllers enables detection of intrusions during off-hours. Besides, real-time alert messages can be sent via LINE or email to the right personnel. With an additional iCAM series - IP Camera, management staff can access live videos/photos of events for further verification.



Sound & Light Alert Module  
**ALM-Horn-RGB**

- ▶ With the ALM series - Alert Module, audible and visual alarms can be triggered once abnormal events are detected.

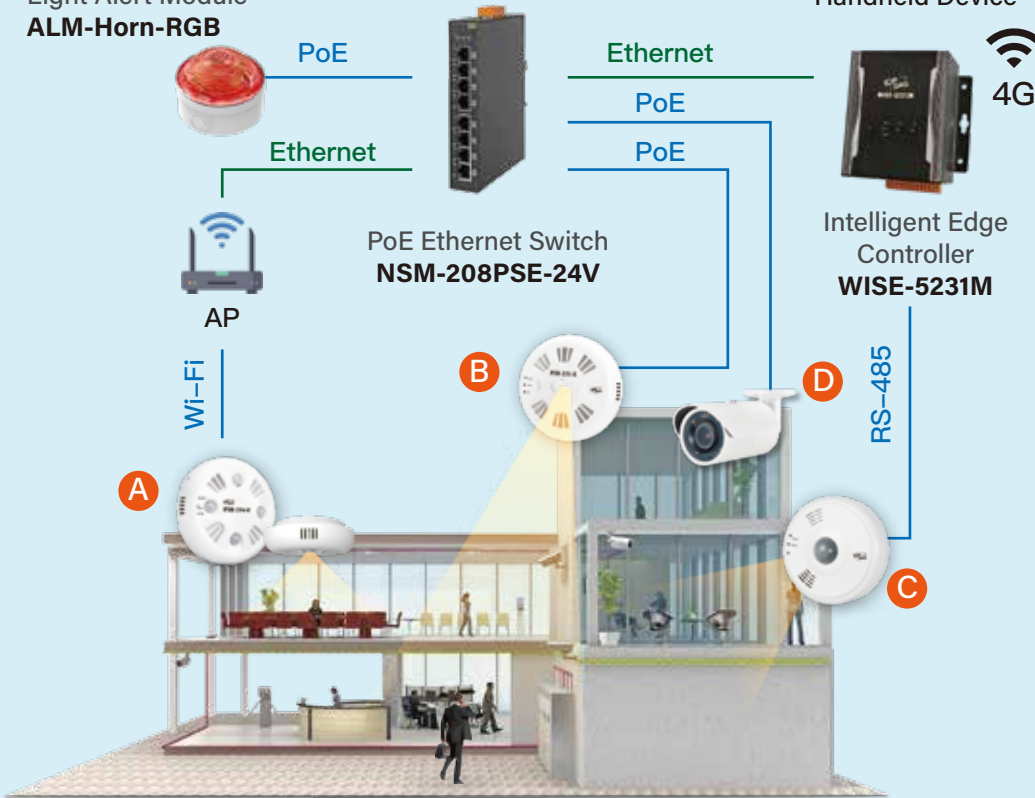

## A PIR-234-WF (High-sensitivity Type)

In meeting rooms, where the movement of individuals are subtle, PIR-234 Motion Sensor Module is recommended for lighting control.

## B PIR-231-E (Long-range Type)

In spaces with high ceilings, PIR-231 Motion Sensor featuring a long detection range (height) is recommended for applications.

## C PIR-130 (Standard Type)

In office buildings, where people pass by often and show noticeable movements, PIR-130 Motion Sensor Module is recommended to detect human walking motion for lighting control.

## D iCAM Series

Once PIR sensors detect an unauthorized intrusion, the iCAM series - IP Camera captures videos and photos which are then displayed in the guardhouse. Alternatively, with the WISE controller, snapshots can be sent via LINE to the right personnel.

PIR-234-E  
PIR-234-WF

High-sensitivity Type

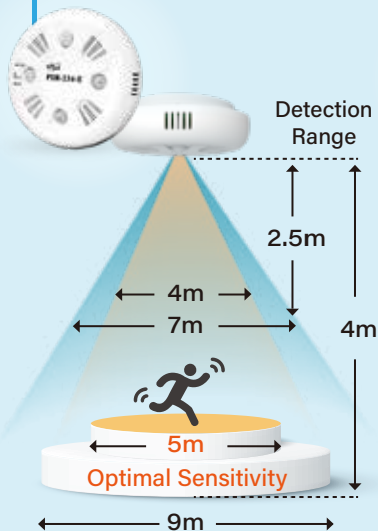

PIR-234L  
PIR-234L-WF

High-sensitivity Type  
(Wide Detection Range)

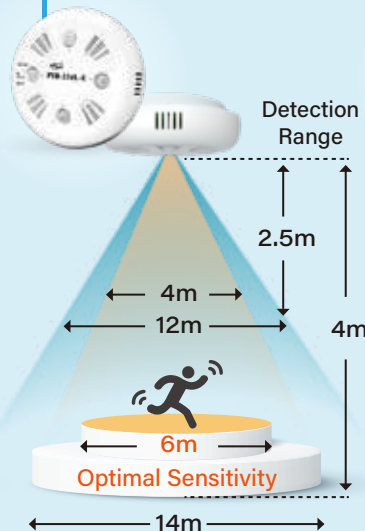

PIR-230 Series  
PIR-130 Series

Standard Type

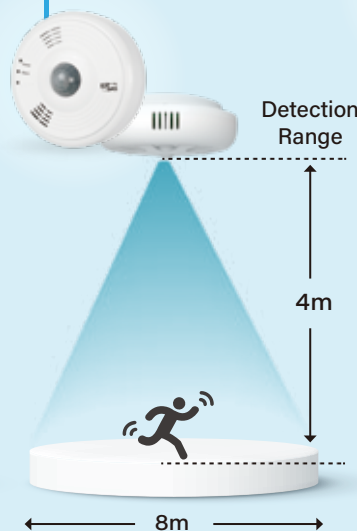

PIR-231 Series

Long-range Type

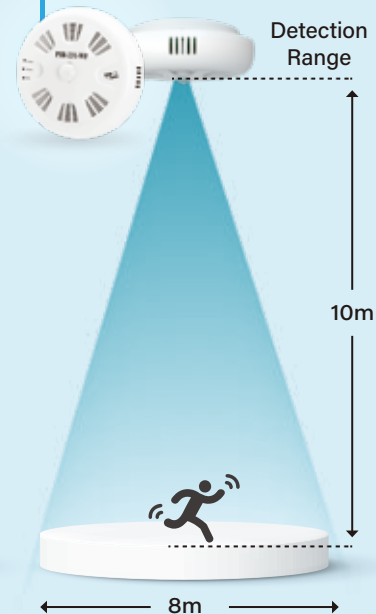

# Selection Guide



**High-sensitivity Type**

Model	Communication Interface	Sensor	DI/DO	Power Supply	Detection Range (Height)	Detection Range (Diameter)
PIR-234-E	RS-485+Ethernet(PoE)	PIR + Temperature + Humidity	2 Relay	DC	4m	9m
PIR-234-WF	RS-485+Ethernet(PoE)+Wi-Fi					
PIR-234L-E	RS-485+Ethernet(PoE)					14m
PIR-234L-WF	RS-485+Ethernet(PoE)+Wi-Fi					



**Long-range Type**

Model	Communication Interface	Sensor	DI/DO	Power Supply	Detection Range (Height)	Detection Range (Diameter)
PIR-231-E	RS-485+Ethernet(PoE)	PIR+T&H	2 DI + 1 Relay	DC	10m	8m
PIR-231-WF	RS-485+Ethernet(PoE)+Wi-Fi					



**Standard Type**

Model	Communication Interface	Sensor	DI/DO	Power Supply	Detection Range (Height)	Detection Range (Diameter)
PIR-230-E	RS-485+Ethernet(PoE)	PIR+T&H	2 DI + 1 Relay	DC	4m	8m
PIR-230-WF	RS-485+Ethernet(PoE)+Wi-Fi					
PIR-130-AC	RS-485	PIR+T	1 Relay	AC	4m	8m
PIR-130-DC	RS-485			DC		

▶ **PoE-capable** PIR-230, PIR-231, and PIR-234 Motion Sensor Module can be supplied with power via Ethernet without additional cabling.

▶ **Support Various Communication Protocols and Interfaces**  
PIR series supports many communication interfaces (RS-485, Ethernet, Wi-Fi) and protocols (DCON, Modbus RTU, Modbus TCP, and MQTT). This allows seamless integration with HMI or SCADA systems and facilitates easy maintenance in distributed systems.

▶ **Built-in Temperature and Humidity Sensors**  
PIR-234, PIR-231, and PIR-230 Motion Sensor Module have built-in temperature and humidity sensors, while the PIR-130 Motion Sensor Module only has the built-in temperature sensor. These sensors enable the PIR modules to offer temperature & humidity monitoring in addition to human motion detection.

▶ **Optional Accessories**



EWB-C150  
Ø120 External Wall Box

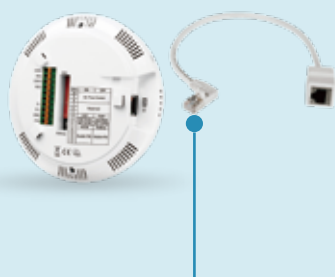

CA-RJ45-04  
RJ45 Cable (Male to Female)

▶ **Installation Type**

**Ceiling Mounting**

(Basic Accessories)



▶ **Installation Type**

**Wall Mounting**

(External Wall Box Required)

