



iSN-81x Series Quick Start

v1.1, Jun 2024

Packing List

In addition to this guide, the package includes the following items:



or



or



iSN-81x-MRTU

iSN-81x-MTCP

iSN-81xC-MTCP



Screw Driver

Resources

Technical Support

service@icpdas.com

www.icpdas.com

How to search for drivers, manuals and spec information on ICP DAS website.

- For Mobile Web

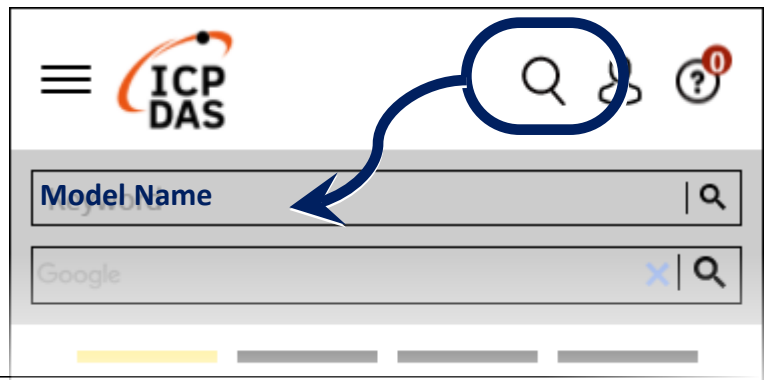

- For Desktop Web

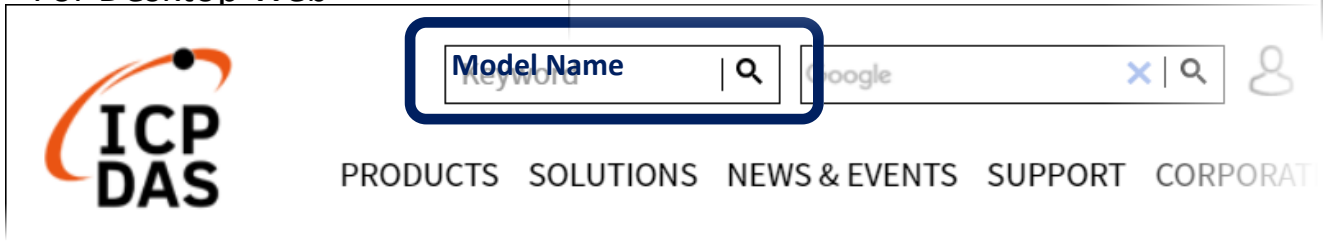

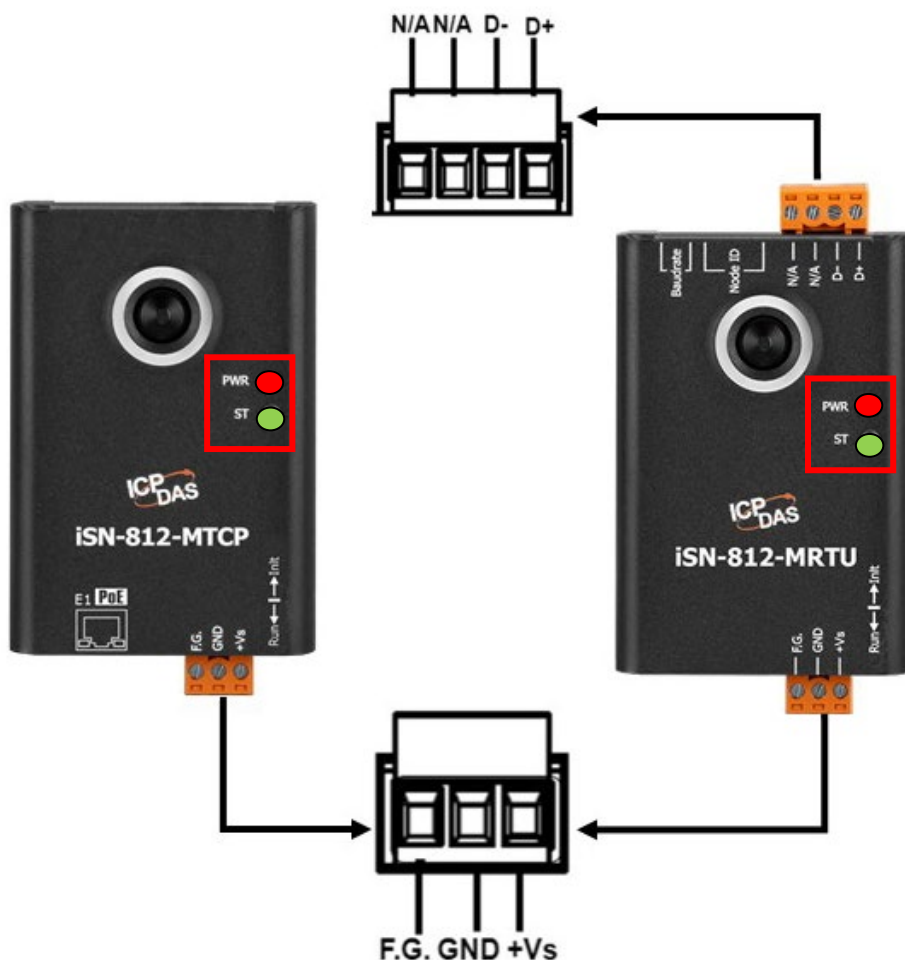

➤ Pin Assignments and LED indicators

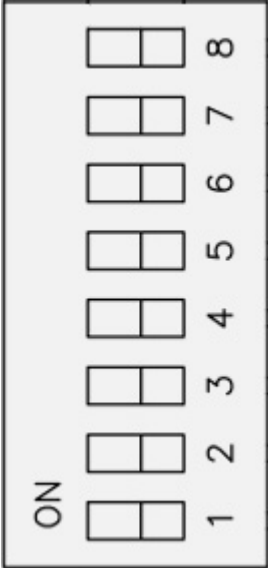

LED Status		Description
PWR	ST	
ON	OFF	Power supply is OK and waiting for connection
ON	ON	The connection established but transmission not yet started.
Flashing (0.05sec)	ON	Thermal data transmission (only for MTCP series)
Flashing (0.05sec)	Flashing (0.5sec)	Thermal data transmission with abnormal temperature judgment (only for MTCP series)
ON	Flashing (0.5sec)	Abnormal temperature judgment
Flashing (0.5sec)	Flashing (0.5sec)	eSearch Locate (only for MTCP series)

➤ DIP Switch

	Pin Number	Function	Example																													
	1~5	Modbus ID (ID range: 1~31)	<table border="1"> <thead> <tr> <th rowspan="2">Modbus ID</th> <th colspan="5">Switch</th> </tr> <tr> <th>1</th> <th>2</th> <th>3</th> <th>4</th> <th>5</th> </tr> </thead> <tbody> <tr> <td>1</td> <td>1</td> <td>0</td> <td>0</td> <td>0</td> <td>0</td> </tr> <tr> <td>10</td> <td>0</td> <td>1</td> <td>0</td> <td>1</td> <td>0</td> </tr> <tr> <td>30</td> <td>0</td> <td>1</td> <td>1</td> <td>1</td> <td>1</td> </tr> </tbody> </table> <p>Note: 1=>ON, 0=>OFF</p>	Modbus ID	Switch					1	2	3	4	5	1	1	0	0	0	0	10	0	1	0	1	0	30	0	1	1	1	1
	Modbus ID	Switch																														
1		2	3	4	5																											
1	1	0	0	0	0																											
10	0	1	0	1	0																											
30	0	1	1	1	1																											
6~8	Baudrate	<table border="1"> <thead> <tr> <th rowspan="2">Baudrate (bps)</th> <th colspan="3">Switch</th> </tr> <tr> <th>6</th> <th>7</th> <th>8</th> </tr> </thead> <tbody> <tr> <td>9600</td> <td>0</td> <td>0</td> <td>0</td> </tr> <tr> <td>19200</td> <td>1</td> <td>0</td> <td>0</td> </tr> <tr> <td>38400</td> <td>0</td> <td>1</td> <td>0</td> </tr> <tr> <td>57600</td> <td>1</td> <td>1</td> <td>0</td> </tr> <tr> <td>115200</td> <td>0</td> <td>0</td> <td>1</td> </tr> </tbody> </table> <p>Note: 1=>ON, 0=>OFF</p>	Baudrate (bps)	Switch			6	7	8	9600	0	0	0	19200	1	0	0	38400	0	1	0	57600	1	1	0	115200	0	0	1			
Baudrate (bps)	Switch																															
	6	7	8																													
9600	0	0	0																													
19200	1	0	0																													
38400	0	1	0																													
57600	1	1	0																													
115200	0	0	1																													
	Init	Device works in waiting to be upload Firmware mode																														
	Run	Device works in normal mode																														

➤ Default IP address

IP	Mask	Gate way
192.168.255.100	255.255.0.0	192.168.0.1

➤ Installation

Wall Mounting:

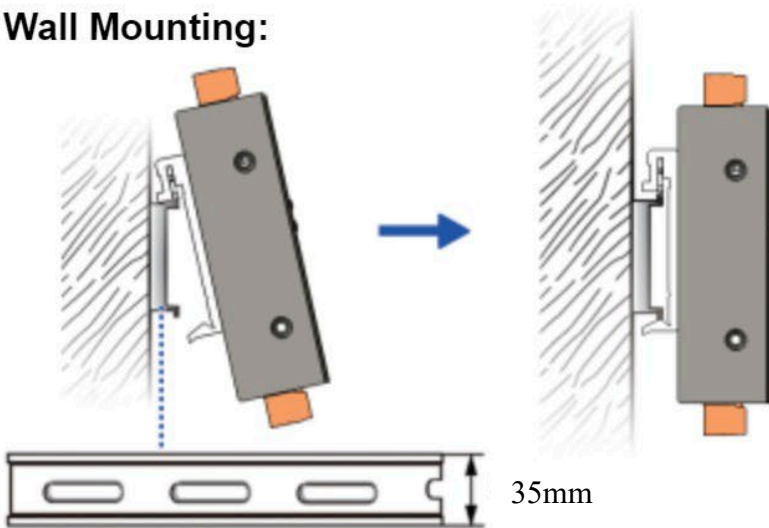

Magnet Mounting:

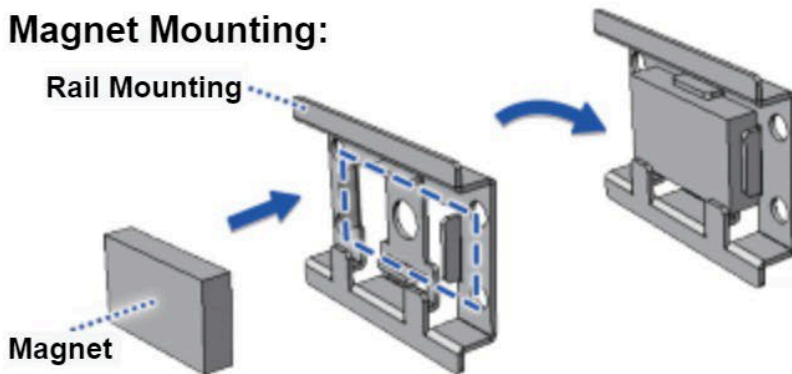

Gimbal Mounting:

