



User Manual

Version 1.40 (2024/03/07)

HRT-710

HRT-310



Written by Edward

Table of Contents

1. Introduction	6
1.1 Features.....	7
1.2 Modbus Function Code Support	8
1.3 Specifications	8
2. Hardware.....	10
2.1 Block Diagram.....	10
2.2 Pin Assignment	10
2.3 Wiring.....	13
2.3.1 RS-232 Wiring	13
2.3.2 RS-485 Wiring	13
2.3.3 RS-422 Wiring	14
2.3.4 HART Wiring.....	14
2.4 LED indicator	18
2.5 DIP Switch	19
2.5.1 The default values in the “Default” mode.....	20
2.6 Jumper	21
2.7 Module Loop Power Wiring (HRT-310)	22
3. HART Introduction	23
3.1 Analog and Digital signal.....	23
3.2 Network topology	24
3.3 HART Frame	26
3.3.1 Preamble	26
3.3.2 Delimiter	26
3.3.3 Address	26
3.3.4 Command.....	26
3.3.5 Byte Count.....	27
3.3.6 Response Codes	27
3.3.7 Data.....	28
3.3.8 Check Byte	28
4. Modbus Communication	29

4.1	Module Execution Process.....	29
4.2	Modbus / HART Mapping Table	30
4.3	Diagnostic Messages	37
4.4	Through Mode.....	38
4.5	Data Exchange Example.....	39
5.	HG_Tool Application	42
5.1	Install .NET Compact Framework	42
5.2	Install HG_Tool.....	44
5.3	HG_Tool Utility	47
5.3.1	Traffic Light	47
5.3.2	Connection Status	47
5.3.3	Connection Control.....	48
5.3.4	Tools	48
5.3.4.1	Communication Settings.....	48
5.3.4.2	Device Information.....	49
5.3.4.3	Device Configuration	56
5.3.4.4	Default Output Data.....	62
5.3.4.5	Address Map	63
5.3.4.6	Device Diagnostic.....	64
5.3.4.7	Through Mode	65
5.3.4.8	Format Translation.....	66
5.3.4.9	About	67
5.4	Establish connection with module	68
6.	Troubleshooting.....	71
7.	Dimensions.....	72
8.	FAQ.....	76
Q01	: How to add HART devices to HRT-710 ?	76
Q02	: How to make sure that HRT-710 gets the HART device data correctly ?	81
Q03	: How to map HART device CMD(3) data directly to SCADA or HMI ?	84
Q04	: How to update the firmware of HRT-710 ?	96
Q05	: How to read HART device CMD1 data with standard format by Modbus ?	100
Q06	: How to read HART device CMD 3 data with standard format by Modbus ?	104
Q07	: How to know the connection status between HRT-710 and HART devices ?	107
Q08	: How to integrate Active and Passive HART devices in multi-drop network ?	112

Q09 : How to integrate multiple HRT-710 in the same RS-485 ?	113
Q10 : How to integrate HART comm. device with RS-232 hardware interface ?	115
Q11 : How to add the HART Device-Specific command to HRT-710 ?	116
Q12 : How to set HART device address by HRT-710 utility ?	119
Q13 : All kinds of HART network wiring ?	122
Q14 : Apply the same settings to the other HRT-710 rapidly ?	126
Q15 : How to send HART command for writing ? (Ex: CMD19).....	128
Q16 : Integrate GT-540/ GT-541M to get HART device data via 3G/ 4G?	131
Q17 : How to get HART command 48 information?	137
Q18 : How to send HART “Burst Mode” CMD? (CMD108/109)	140
Q19 : How to reset totalizer value by sending Device-Specific command?	145
Q20 : How to read total-flow data from flow-meter?.....	147
Q21 : HART communication update period calculation and adjustment	149
Q22 : Integrate HART communication to traditional AI structure.....	151
Q23 : HART Multi-drop mode precautions	153
Q24 : HART communication distance issues	156
Q25 : Using Through Mode of HG_Tool to Stop Burst Mode of HART Device	159
Q26 : How to use the In_Offset field of the UserCMD ?	161
Q27: How to use “Listen Only” function to get HART data?	166
Q28 : Using multiple HART CMD33 in “Listen Only” mode ?	171
Q30 : How to get HART command 9 information ?	175
Q31 : Integrate HART device with burst mode ?	182
Appendix A. HART Command.....	185
Appendix B. Command Format	191
Appendix C: Version History	192

Important Information

Warranty

All products manufactured by ICP DAS are under warranty regarding defective materials for a period of one year, beginning from the date of delivery to the original purchaser.

Warning

ICP DAS assumes no liability for any damage resulting from the use of this product. ICP DAS reserves the right to change this manual at any time without notice. The information furnished by ICP DAS is believed to be accurate and reliable. However, no responsibility is assumed by ICP DAS for its use, not for any infringements of patents or other rights of third parties resulting from its use.

Copyright

Copyright © 2017 by ICP DAS Co., Ltd. All rights are reserved.

Trademark

Names are used for identification purpose only and may be registered trademarks of their respective companies.

Contact us

If you encounter any problems while operating this device, feel free to contact us via mail at: service@icpdas.com . We guarantee to respond within 2 working days.

1. Introduction

Modbus and HART are two kinds of famous protocols and used widely in the fields of factory and process automation. The HRT-710 / HRT-310 module is a Modbus to HART gateway. By using this module, users can integrate their HART devices into Modbus network easily. The below figure is the application of HRT-710 / HRT-310.

(Note : The below description of HRT-710 / HRT-310 will be HRT-7(3)10)

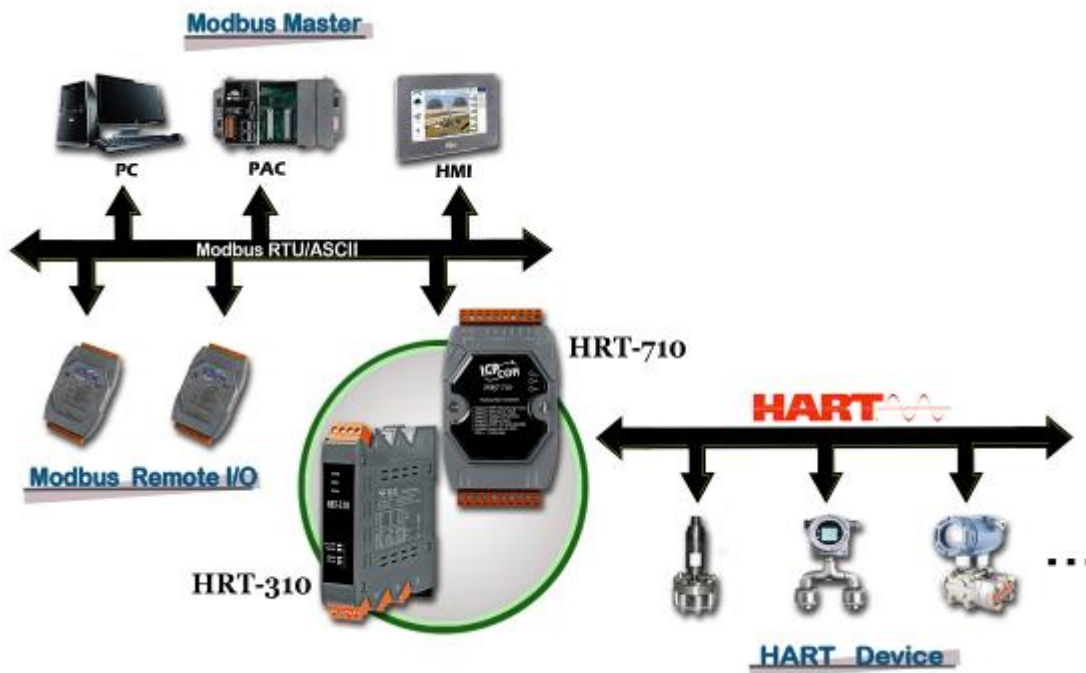

Figure 1: The application of HRT-710 / HRT-310

The below table are the difference between HRT-710 and HRT-310.

	HRT-710	HRT-310
Din Rail Installation	Horizontal	Upright
HART Signal	Standard	Enhanced send/receive signal (For long distance comm.)
Loop Power	No	Support (module provides +30V output)
Built-In Resistor	earlier than V1.30 : 250 Ohm (1/4W) V1.30 and later : 250 Ohm (2W)	250 Ohm (2W)

[Note]

1. The software settings for HRT-710 and HRT-310 are all the same and HG_Tool can be used for them. The main features and specifications of HRT-7(3)10 are described as below.

1.1 Features

■ Hardware

- ◆ Support HART Short/Long frame.
- ◆ Support HART Burst mode.
- ◆ Allow two HART Masters.
- ◆ Support Modbus RTU and ASCII format.
- ◆ Support Modbus Slave / HART Master Mode.
- ◆ Support firmware update via Com Port. (FW_v1.2 and HW_v1.2)
- ◆ Support on-line replacement of HART devices. (FW_v1.5)
- ◆ Support acquire long frame address automatically (FW_v1.5)
- ◆ Isolated COM 1: RS-232/422/485.
- ◆ Provide LED indicators.
- ◆ Built-in Watchdog.
- ◆ DIN-Rail or Wall Mounting.

1.2 Modbus Function Code Support

HRT-7(3)10 supports the following Modbus Function Code commands.

[Table 1: Modbus Function Codes]

FC	Description
01	Read multiple coils status
02	Read multiple discrete inputs
03	Read multiple Holding registers
04	Read multiple input registers
05	Write single coil
06	Write single register
15	Force multiple coils
16	Write multiple registers

1.3 Specifications

[UART Spec.]

- ◆ COM: RS-232(3 wire) / RS-422 / RS-485
- ◆ HRT-710 Connector: 9-pin screwed terminal block
- ◆ HRT-310 Connector: 4-pin screwed terminal block
- ◆ Baud Rate: 1200 ~ 115200 bps
- ◆ Data Format:
 - [1] data bits : 7/8
 - [2] parity : None/Odd/Even
 - [3] stop bit : 1/2

[HART Spec.]

- ◆ Channel number: 1
- ◆ Connector: 2-pin screwed terminal block
- ◆ Operates as a HART Master station and supports all HART commands
- ◆ Frame: Short or Long
- ◆ Network: Point to Point or Multi-drop

- ◆ Max. 15 HART modules
- ◆ Max. 100 user commands and 32 default commands

[Power Requirement]

- ◆ Unregulated +10 ~ +30 VDC
- ◆ Power reverse protection, Over-Voltage brown-out protection
- ◆ HRT-710 Power consumption: 1.0 W
HRT-310 Power consumption: 3.5 W (Max.)

[Module Spec.]

- ◆ HRT-710 Dimensions: 72 mm x 121 mm x 35 mm (W x L x H)
HRT-310 Dimensions: 25 mm x 116 mm x 120 mm (W x L x H)
- ◆ Operating temperature: -25 ~ 75 °C
- ◆ Storage temperature: -30 ~ 80 °C
- ◆ Humidity: 5 ~ 95% RH, non-condensing
- ◆ LED Status Indicators (Table 2)

[Table 2: LED status indicator]

PWR LED	Show module power status
ERR LED	Show HART communication error status
RUN LED	Show module operation status

2. Hardware

2.1 Block Diagram

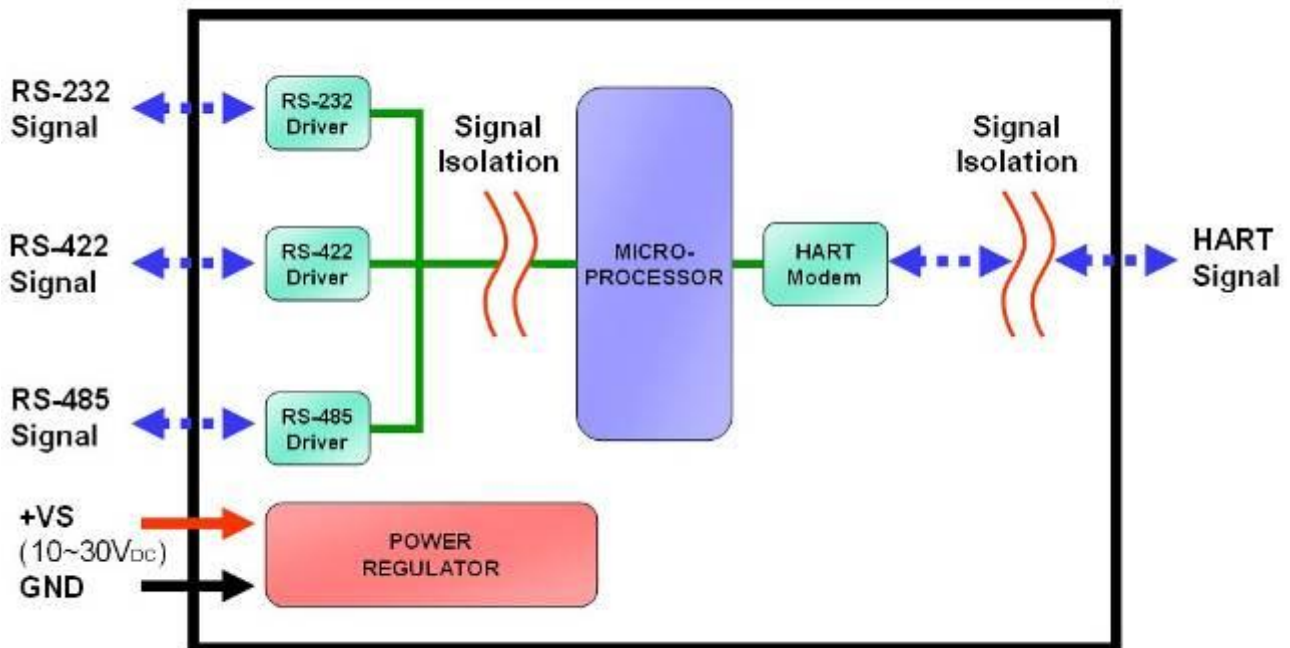

Figure 2: Block diagram

2.2 Pin Assignment

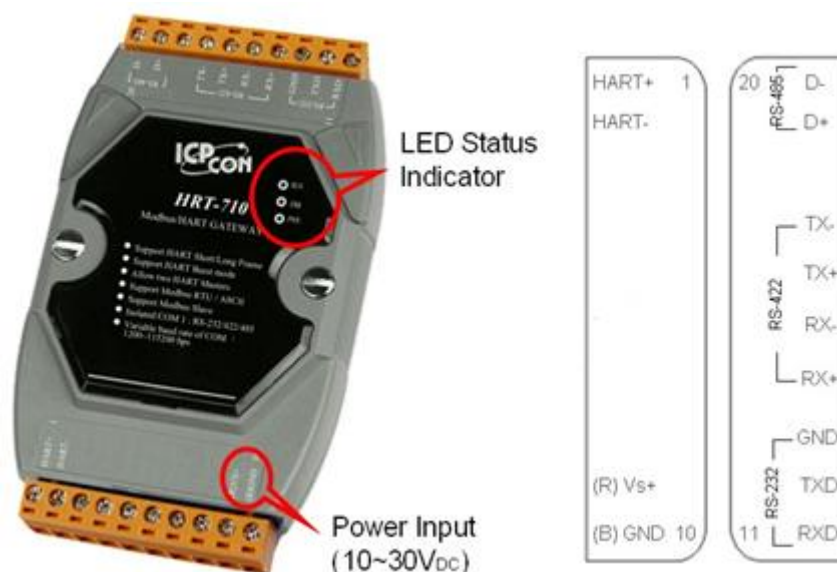
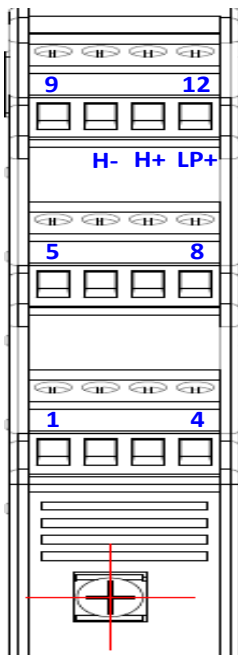
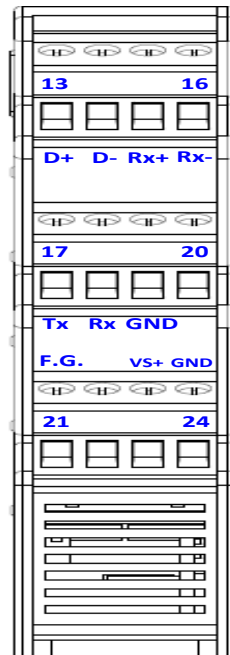

Figure 3.1: Pin assignment of HRT-710



Top View



Bottom View

Figure 3.2: Pin assignment of HRT-310

[Table 3: Screw terminal block]

Name	HRT-710 Pin	HRT-310 Pin	Description
LP+	N/A	12	V+ of Loop Power (+30Vdc)
HART+	1	11	Positive of HART
HART-	2	10	Negative of HART
+VS	9	23	V+ of Power Supply (+10 ~ +30 Vdc)
GND	10	24	GND of Power Supply
RXD	11	18	Receive Data of RS-232
TXD	12	17	Transmit Data of RS-232
GND	13	19	GND of RS-232
RX+	14	15	Receive Data+ of RS-422
RX-	15	16	Receive Data- of RS-422
TX+	16	13	Transmit Data+ of RS-422
TX-	17	14	Transmit Data- of RS-422
D+	19	13	Data+ of RS-485
D-	20	14	Data- of RS-485

2.3 Wiring

It is recommended to use only one serial port interface (RS232, RS422 or RS485) of the HRT(3)-710 module at a time. The following section describes the necessary steps to connect one of the three COM port types to a Modbus network.

2.3.1 RS-232 Wiring

The RS-232 port of the HRT-7(3)10 has only three pins. The wiring of the RS-232 device with the RS-232 port of the HRT-7(3)10 is shown as Figure 4.

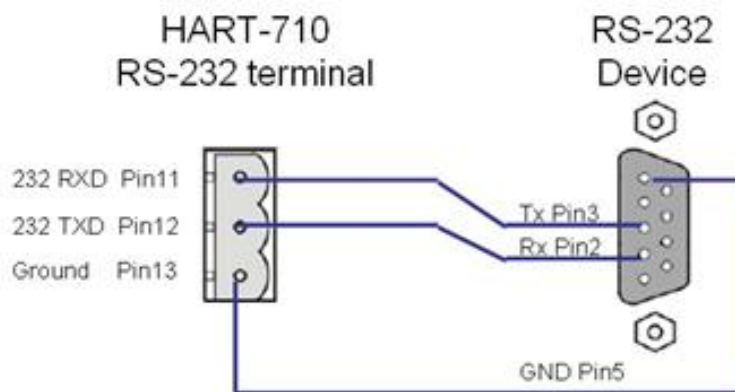

Figure 4: RS-232 wiring diagram

2.3.2 RS-485 Wiring

The RS-485 wiring is shown as Figure 5.

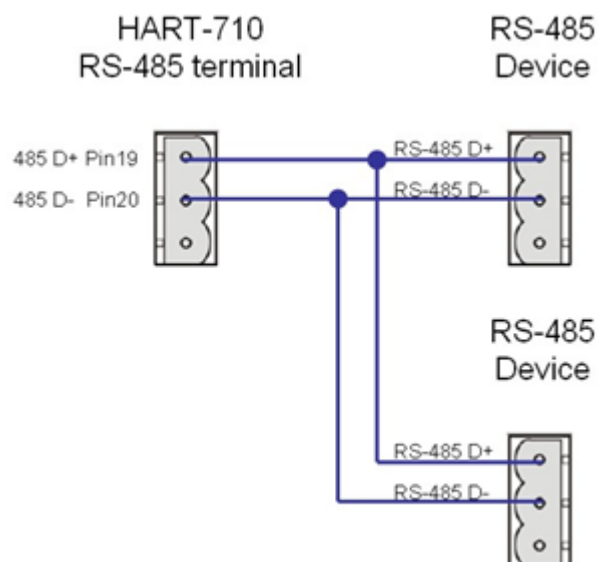

Figure 5: RS-485 wiring diagram

2.3.3 RS-422 Wiring

The RS-422 wiring is shown as Figure 6.

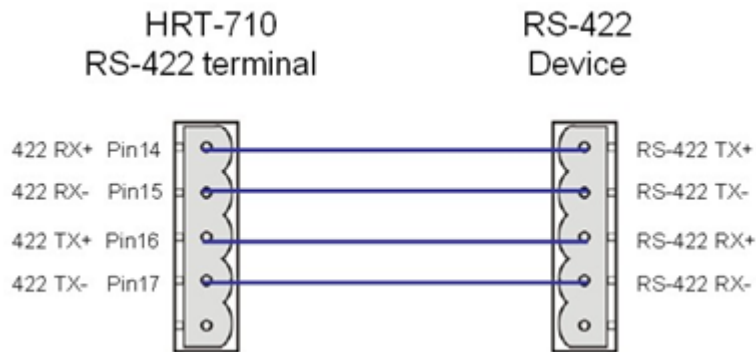

Figure 6: RS-422 wiring diagram

2.3.4 HART Wiring

The HART bus wiring is divided into the below two types:

- (1) "Point-to-Point" mode.
- (2) "Multi-drop" mode.

(1) "Point-to-Point" mode.

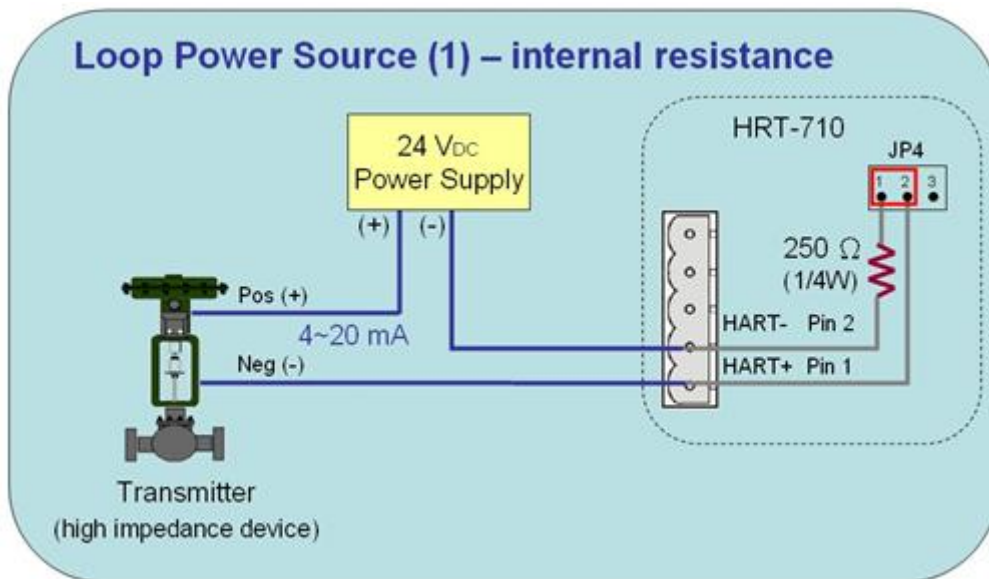

Fig 2.3.4-1 : "P2P" mode (Two-wired HART device, Module Internal Resistor)

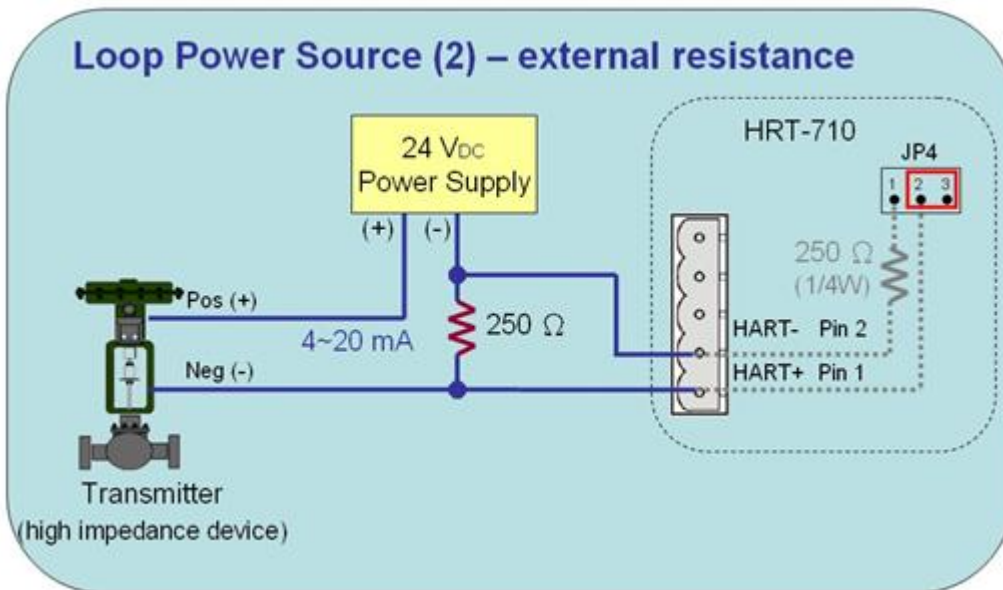

Fig 2.3.4-2 : “P2P” mode (Two-wired HART device, External Resistor)

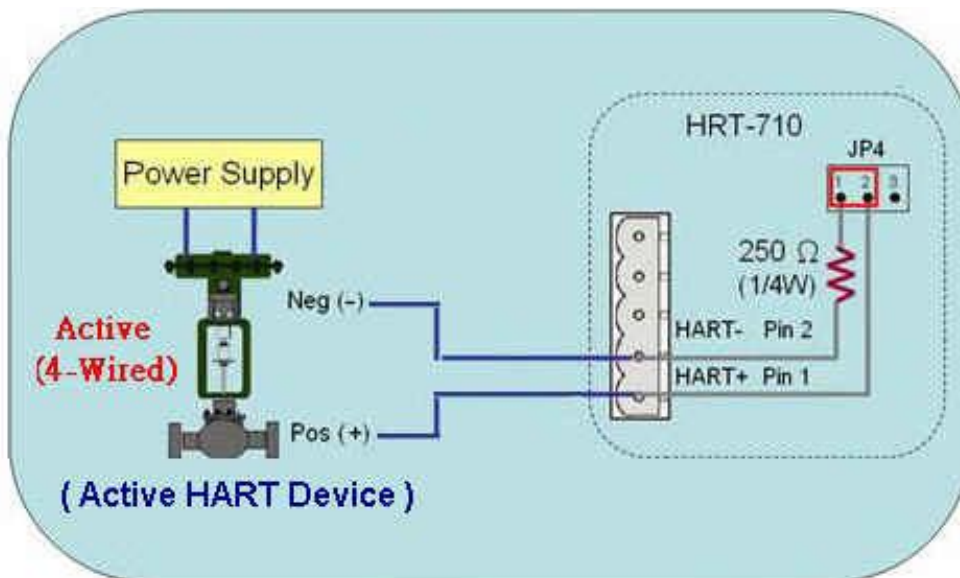

Fig 2.3.4-3 : “P2P” mode (Four-wired HART device)

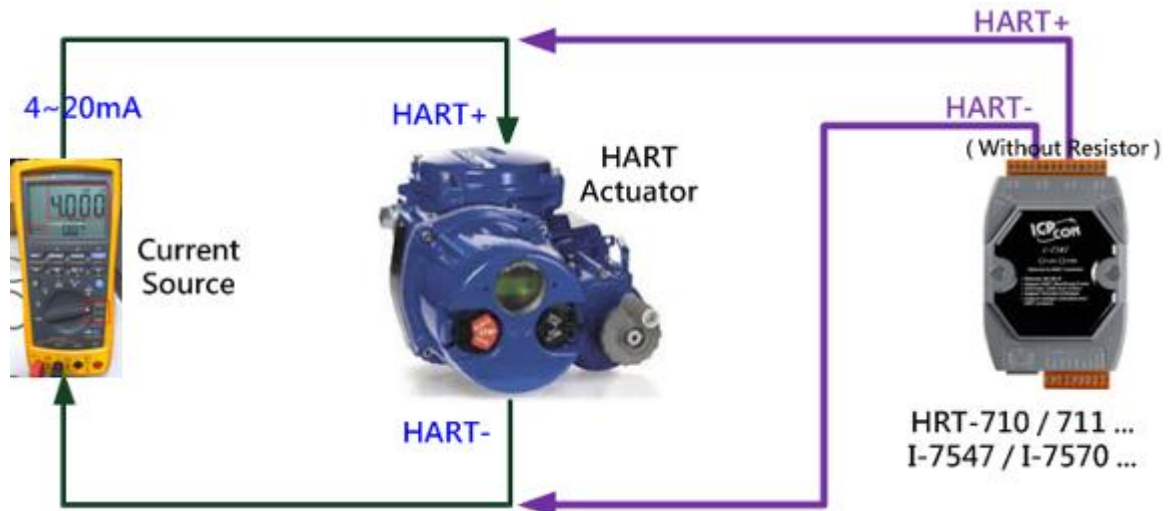

Fig 2.3.4-4 : "P2P" mode (HART Actuator, Without External Resistor)

(1) "Multi-drop" mode.

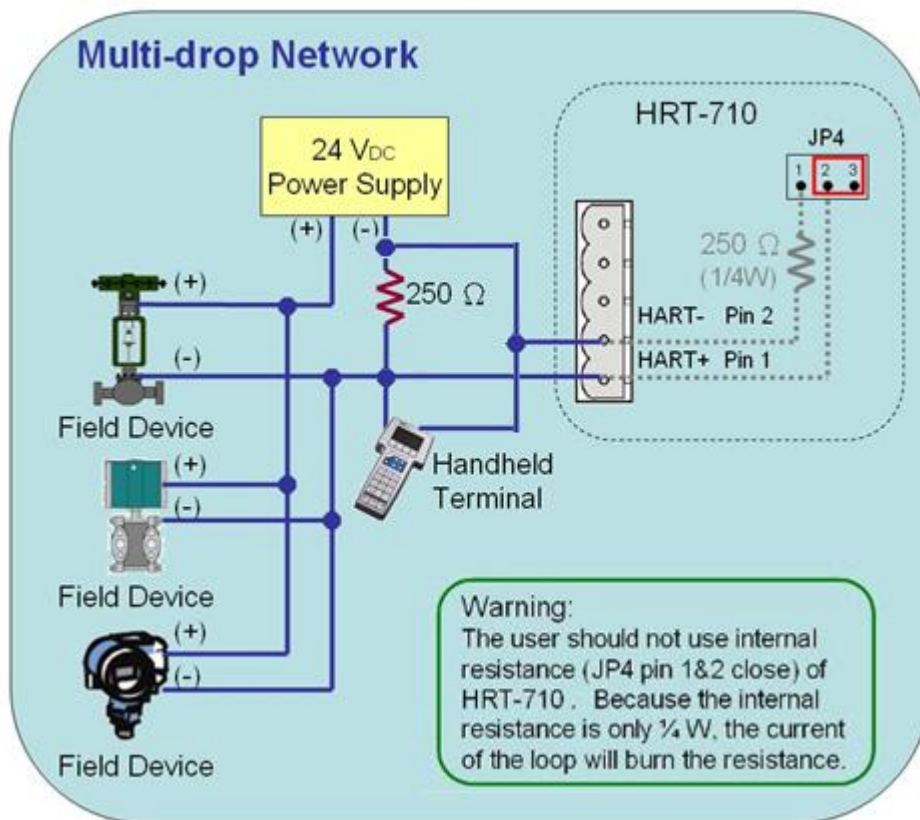

Fig 2.3.4-4 : "Multi-drop" mode (Two-wired HART device)

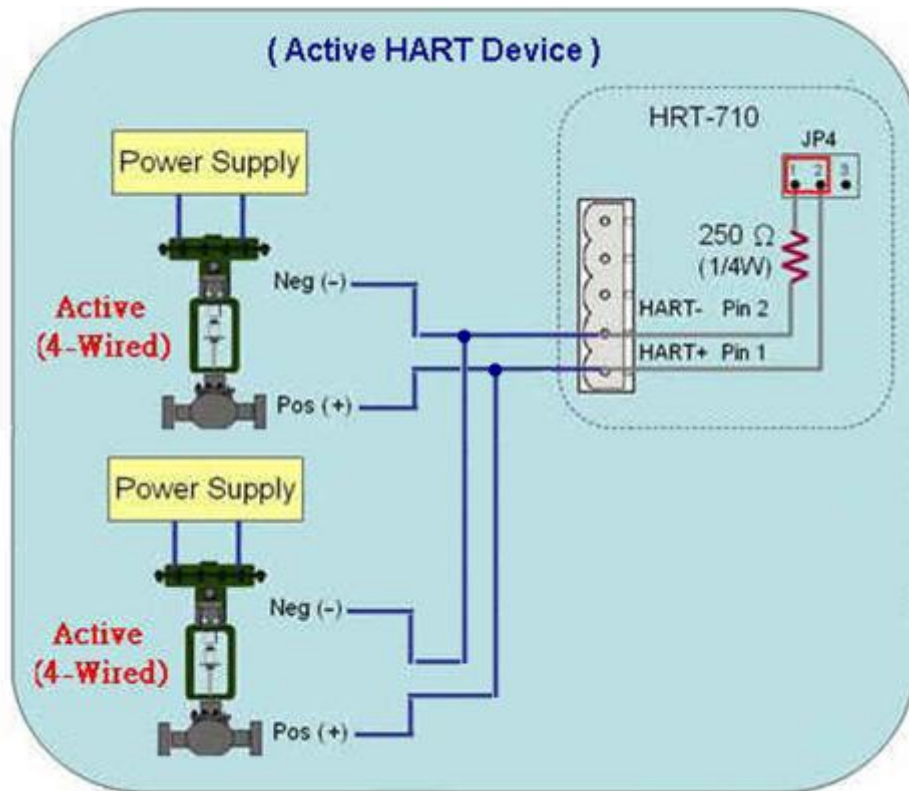

Fig 2.3.4-5 : “Multi-drop” mode (Four-wired HART device)

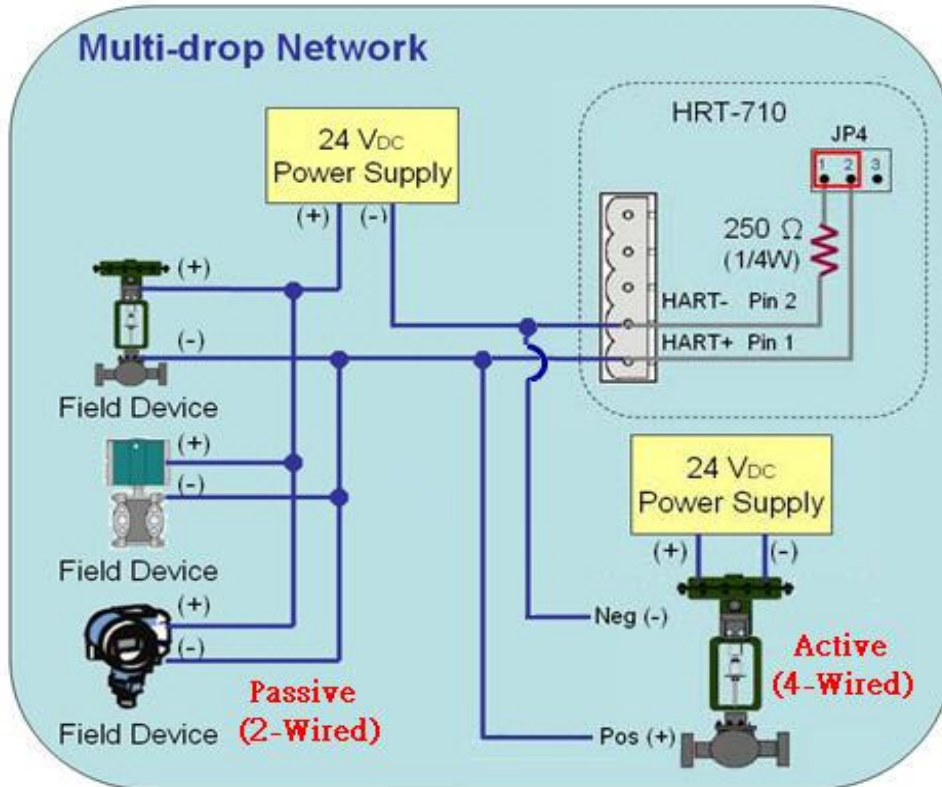

Fig 2.3.4-6 : “Multi-drop” mode (Two-wired and Four-wired HART device)

2.4 LED indicator

The HRT-7(3)10 provides three LEDs to indicate the module and the HART communication status.

[Table 4: LED status description]

LED Name	Status	Description
PWR	ON	Power Supply OK.
	OFF	Power Supply Failed.
ERR	Flash	HART Comm. Error.
	OFF	HART Comm. OK
RUN	Flash	[Flash per second] Module in initial mode. [Flash per half second] Module received the burst frame from HART device.
	ON	Module in normal operation.
	OFF	Firmware has not been loaded yet.

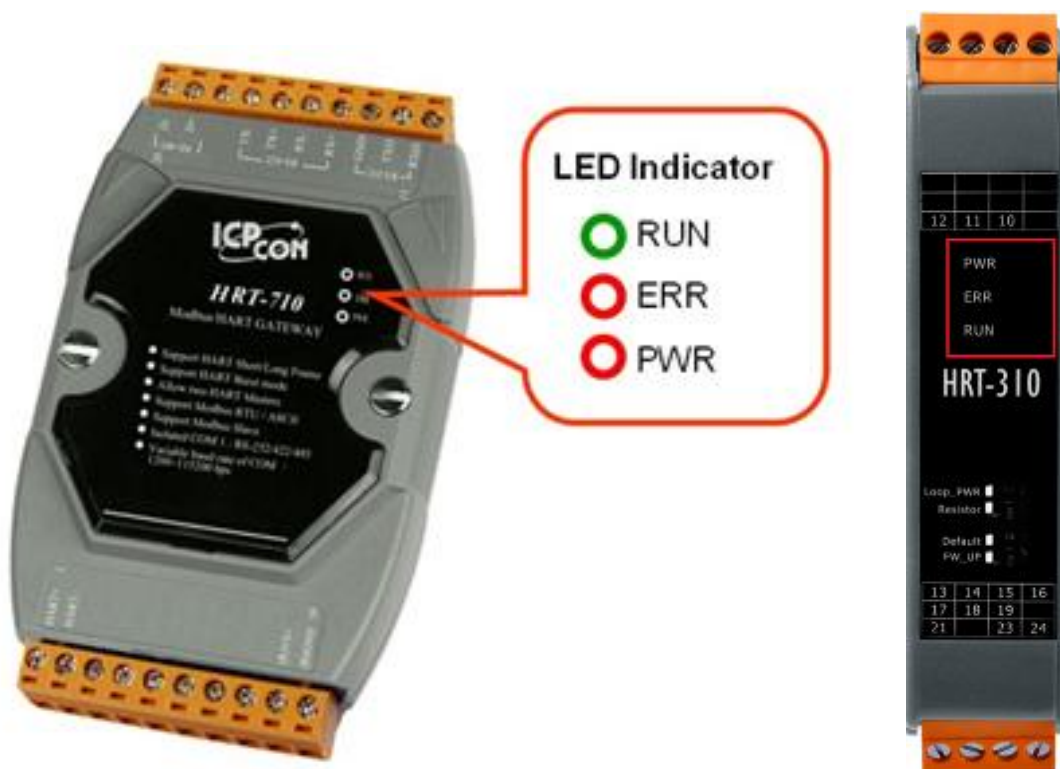

Figure 11: HRT-710 / HRT-310 LED indicator

2.5 DIP Switch

1. HRT-710 :

There is a DIP Switch on the backplane of the HRT-710, as shown in Figure 12.

(1) “Normal” :

[1] The user’s settings will be adapted in HRT-710.

[2] In normal operation, set the DIP Switch to the “Normal” position.

(2) “Default” :

[1] The system default settings will be adapted in HRT-710.

[2] When users forgot the settings of HRT-710 and can’t connect to HRT-710 successfully, users can set the DIP Switch to the “Default” position and reset HRT-710. Then the default settings (refer to section 2.5.1) of HRT-710 will be adapted.



Figure 12-1: DIP Switch of the HRT-710

2. HRT-310 :

There are 4 dip-switches on the HRT-310 and these functions are as below.

Item	OFF	ON
Loop PWR	Adapt the external power for HART loop (Default)	Adapt the Loop Power for HART loop (Wiring refer to section 2.7)
Resistor	Disable HART loop resistor	Enable HART loop resistor (Default) (250 Ohm, 1W)
Default	Adapt the user’s settings (Default)	Adapt the default settings. (Refer to section 2.5.1)
FW Update	Firmware Operation (Default)	Firmware Update (Refer to the Q04 of FAQ)

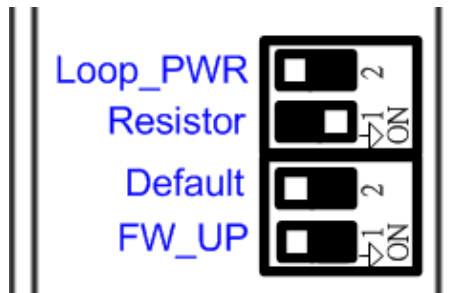

Figure 12-2: DIP Switches of the HRT-310

2.5.1 The default values in the “Default” mode.

[System Default Value]

Item	Value
HART Cmd interval	1000 ms
HART Cmd timeout value	1000 ms
Auto. Polling	Enabled
Retry count	3

[Modbus Default Value]

Item	Value
Baud rate	115200 bps
Date bits	8 bits
Stop bits	1 bit
Parity	None
Net ID (Modbus ID)	1
Protocol	Modbus RTU Slave
Swap mode	None

2.6 Jumper

1. HRT-710 :

There is a Jumper (JP4) in the HRT-710 module shown as Figure 13. The jumper can provide HART bus with 250Ω (1/4 W) resistor. When the pin 1&2 of JP4 is closed, the resistor will connect to HART bus. When the pin 2&3 of JP4 is closed or JP4 without jumper connected, it will disconnect the resistor from HART bus. By default, the pin1&2 of JP4 is closed. Please refer to section 2.3.4 - HART connection for detail.

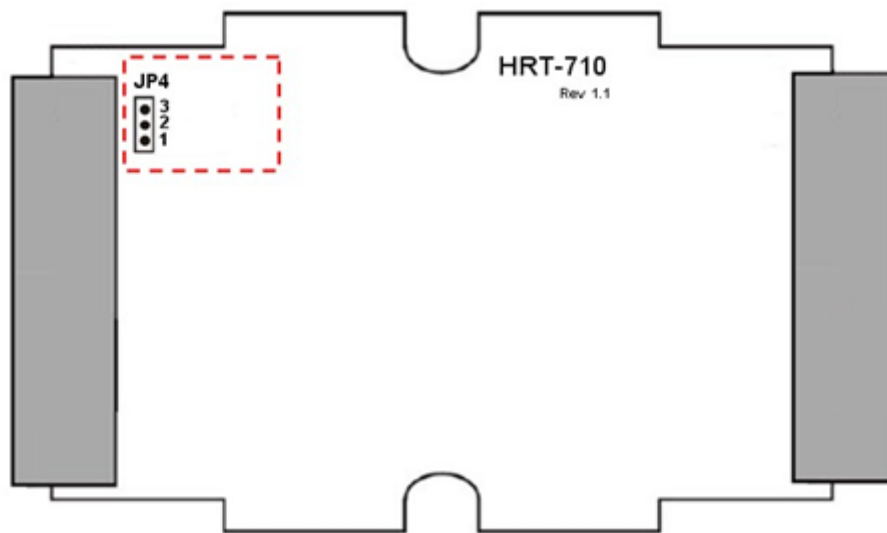
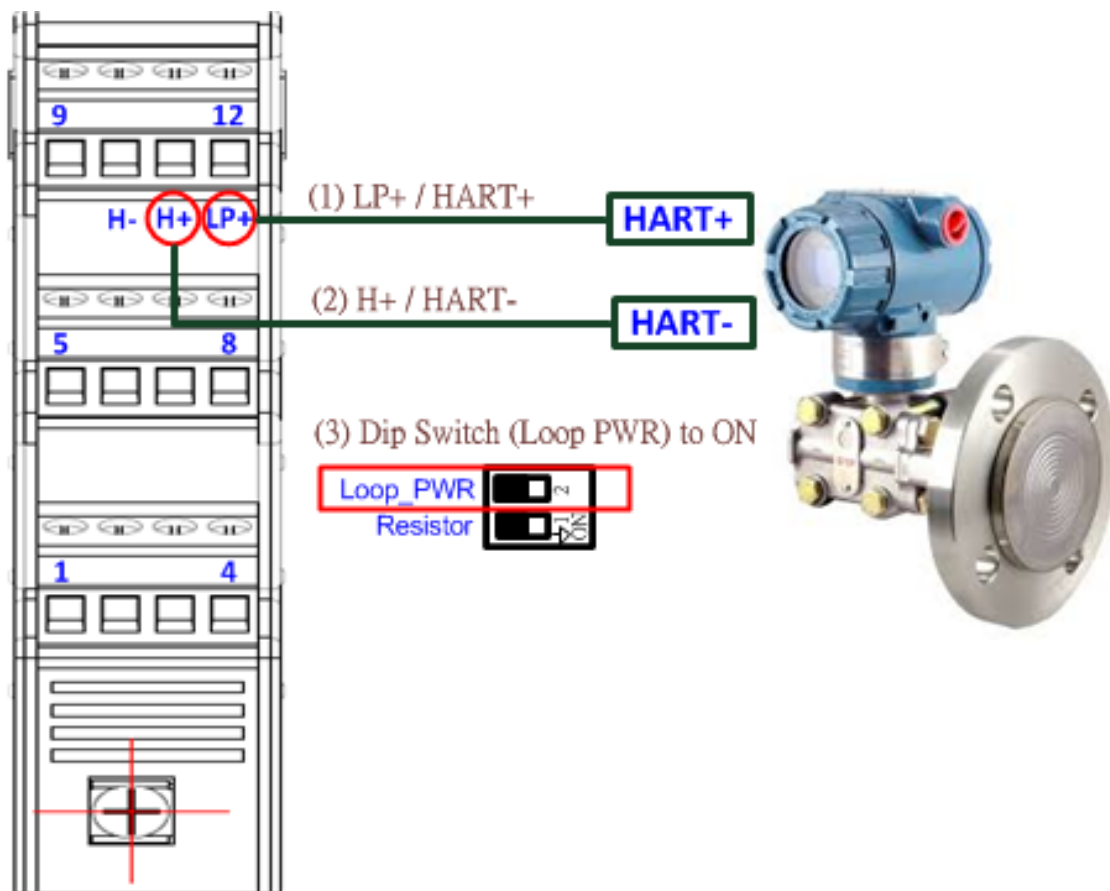

Figure 13: Jumper of the HRT-710

2.7 Module Loop Power Wiring (HRT-310)

HRT-310 supports “Loop Power” function and it means HRT-310 can provide +30V via “LP+” pin. The “Loop Power” wiring is as below.

- (1) Connect the “LP+” (+30V) of HRT-310 to the “HART+” pin of HART device.
- (2) Connect the “H+” of HRT-310 to the “HART-” pin of HART device.
- (3) Turn the “dip-switch of Loop Power” in HRT-310 to “ON” position.
(It will connect the “H-” of HRT-310 to the internal “LP-” of HRT-310.)



(Note: HRT-710 doesn't support the Loop Power function.)

3. HART Introduction

3.1 Analog and Digital signal

The HART communication protocol is based on the Bell 202 telephone communication standard and operates using the frequency shift keying (FSK, Figure 14) principle. The digital signal is made up of two frequencies - 1,200 Hz and 2,200 Hz representing bits 1 and 0, respectively. Sine waves of these two frequencies are superimposed on the direct current (dc) analog signal cables to provide simultaneous analog and digital communications (Figure 15).

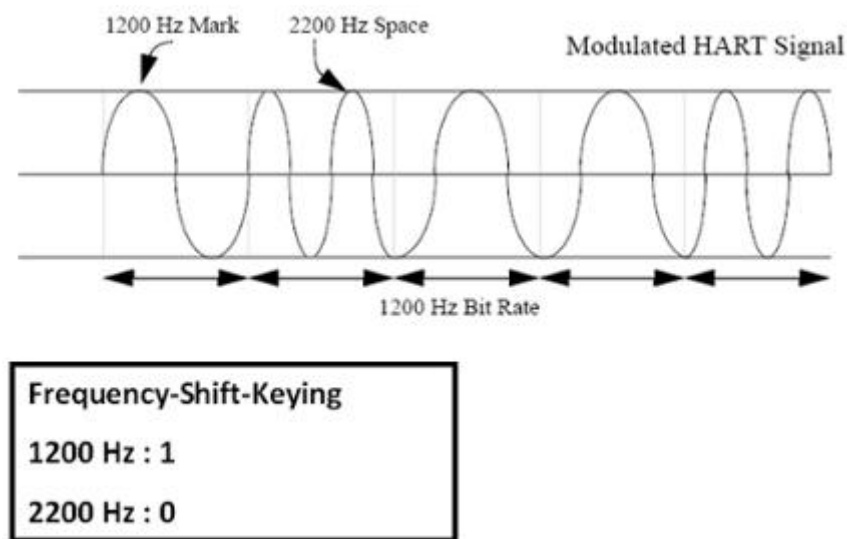

Figure 14: FSK signal

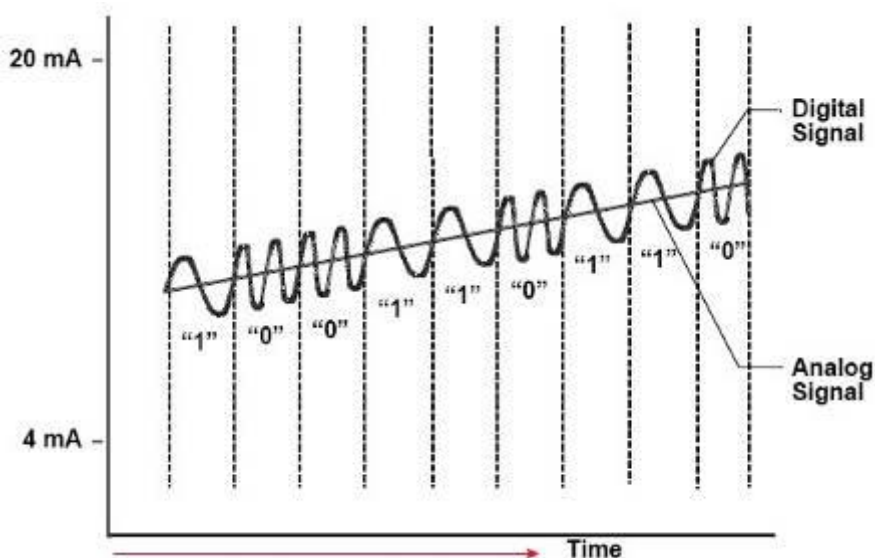

Figure 15: Analog and digital signals

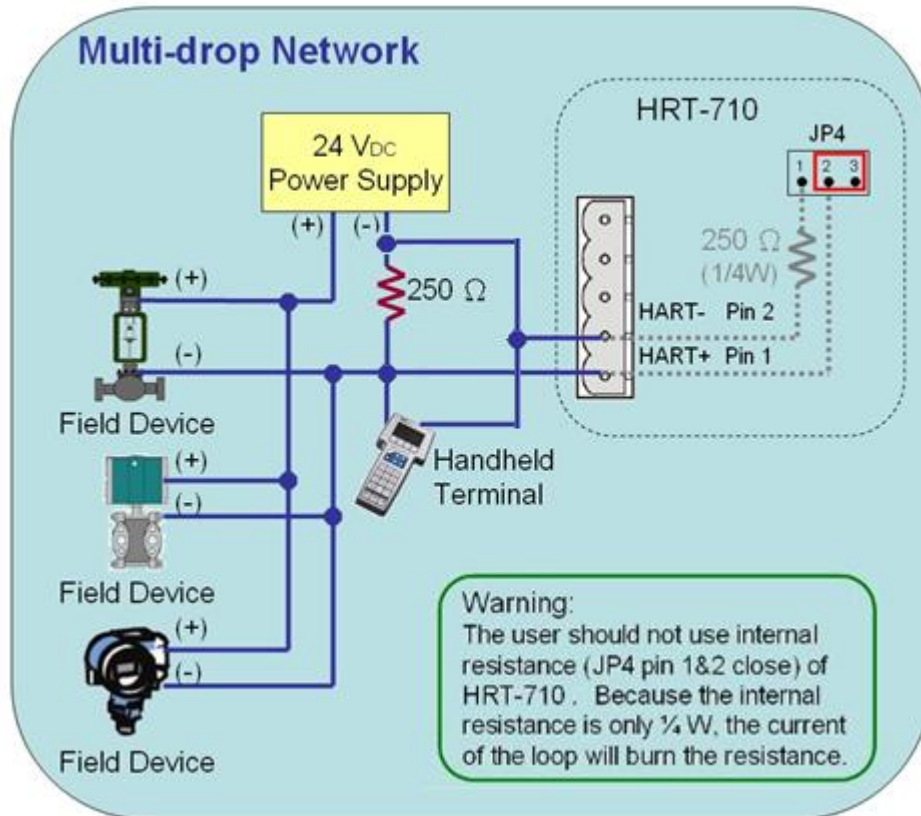

Figure 17: “Multi-drop” topology

3.3 HART Frame

The HART frame format is shown as below:

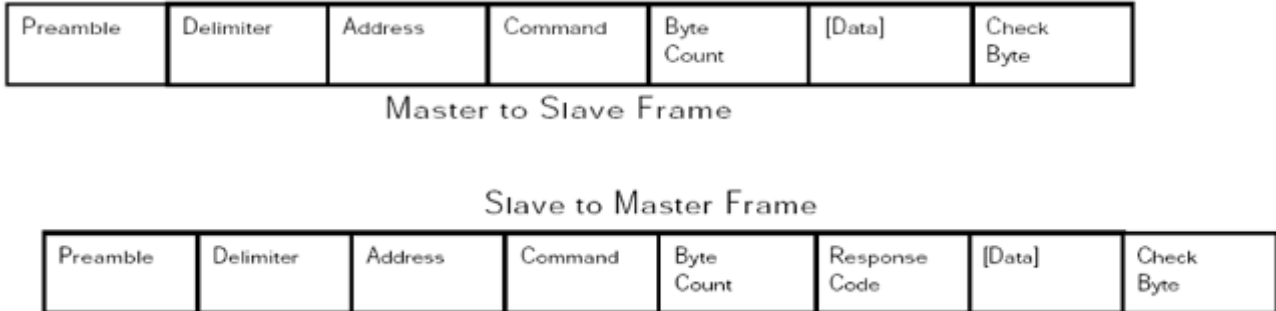

Figure 18: HART frame format

3.3.1 Preamble

All frames transmitted by HART master or slave devices are preceded by a specified number of "0xFF" characters and they are called the preamble. The number of preamble can't be less than 5 and more than 20.

3.3.2 Delimiter

This data can indicate the frame is long or short frame and the frame is master frame, slave frame or burst frame.

3.3.3 Address

If the HART frame is short frame, the address field is only one byte. If it is long frame, the address field is 5 bytes and include manufacturer ID, device type and device ID.

3.3.4 Command

The HART command set includes three classes shown as below.

- (1) Universal Command
- (2) Common-Practice Command
- (3) Device-Specific Command

Command Number	Command Class
0	Universal
.	.
.	.
.	.
30	Universal
31	Reserved

32	Common Practice

•	•
•	•
•	•
127	Reserved

128	Transmitters-Specific
•	•
•	•
•	•
253	Transmitters-Specific

254	Reserved
255	Reserved

About the often used HART command, please refer to “Appendix A: HART command”.

3.3.5 Byte Count

It is the number of bytes between it and the check byte the end of the HART frame.

3.3.6 Response Codes

It includes two bytes of status. These bytes convey three types of information: Communication errors, Command response problems and Field device status. They are shown as below.

[First Byte]

bit 7: 1 (communication error)

bit 6: Parity error

bit 5: Overrun error

bit 4: Framing error

bit 3: Checksum error

bit 2: 0(reserved)

bit 1: Rx buffer overflow

bit 0: Overflow (undefined)

[bit 7=0 (Comm. OK) ; Bit 0~6: as an integer, not bit-mapped]

0: No command-specific error

1: (undefined)

2: Invalid selection

3: Passed parameter too large

4: Passed parameter too small

5: Too few data bytes received

6: Device-specific command error (rarely used)

7: In write-protect mode
8-15: Multiple meanings
16: Access restricted
28: Multiple meanings
32: Device is busy
64: Command not implemented

[Second Byte - Field device status]

bit 7: Field device malfunction
bit 6: Configuration changed
bit 5: Cold start
bit 4: More status available
bit 3: Analog output current fixed
bit 2: Analog output saturated
bit 1: Non-primary variable out of limits
bit 0: Primary variable out of limits.

[Note]

When HART communication error is reported in the first byte, the second byte will be 0.

3.3.7 Data

The contents of the data are decided by HART command number.

3.3.8 Check Byte

Every HART frame has a check byte at the last data byte. HART device can detect error frame by this byte.

4. Modbus Communication

4.1 Module Execution Process

When HRT-7(3)10 module power on, it will enter the “Initial” mode first and then enter the “Operation” mode.

- (1) When HRT-7(3)10 runs under “Initial” mode, it will execute all initial commands and the “RUN” LED will flash.
- (2) When HRT-7(3)10 runs under “Operation” mode, it will execute all polling commands automatically and the “RUN” LED will be always on.

[Note]

The “Auto Polling” function must be set to “Enable” and all polling command will be executed automatically.

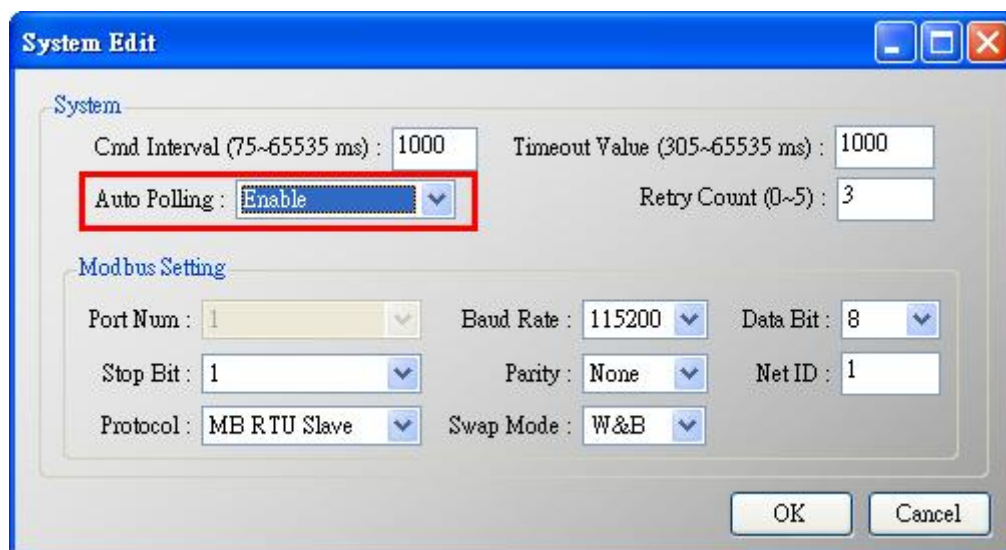

4.2 Modbus / HART Mapping Table

Users can access the HART device by using these Modbus address defined by HRT-7(3)10 module. These Modbus address can be divided into two parts as below.

- (1) Input Data Area (FC04)
- (2) Output Data Area (FC06, 16)

[Note]

The meaning of every Modbus address in the below table is according to the setting of SWAP Mode to be None. If the setting of SWAP Mode is Byte or WORD or W&B, then the meaning of every Modbus address in the below table will be moved one byte or word address.

[Table 5: Modbus / HART Mapping Table]

INPUT DATA AREA		
MB_Addr (HEX)	MB_Addr (Decimal)	Description
[User CMD Data]		
0~1F3	0~499	“User CMD” data
[Module State Data]		
1F4	500L	Module state machine
1F4	500H	Module request command count
1F5	501L	Module receive command count
1F5	501H	Module receive error command count
1F6	502L	Module error status
1F6	502H	Module error command index
1F7~1F9	503~505	Reserved
[Default CMD(0) Data]		
1FA~200	506~512	“Default CMD(0)” input data of “Module 0”
201~207	513~519	“Default CMD(0)” input data of “Module 1”
208~20E	520~526	“Default CMD(0)” input data of “Module 2”
20F~215	527~533	“Default CMD(0)” input data of “Module 3”
216~21C	534~540	“Default CMD(0)” input data of “Module 4”
21D~223	541~547	“Default CMD(0)” input data of “Module 5”

INPUT DATA AREA		
MB_Addr (HEX)	MB_Addr (Decimal)	Description
224~22A	548~554	"Default CMD(0)" input data of "Module 6"
22B~231	555~561	"Default CMD(0)" input data of "Module 7"
232~238	562~568	"Default CMD(0)" input data of "Module 8"
239~23F	569~575	"Default CMD(0)" input data of "Module 9"
240~246	576~582	"Default CMD(0)" input data of "Module 10"
247~24D	583~589	"Default CMD(0)" input data of "Module 11"
24E~254	590~596	"Default CMD(0)" input data of "Module 12"
255~25B	597~603	"Default CMD(0)" input data of "Module 13"
25C~262	604~610	"Default CMD(0)" input data of "Module 14"
263~269	611~617	"Default CMD(0)" input data of "Module 15"
[Default CMD(3)(N) Data]		
26A~276	618~630	"Default CMD(3)(N)" data of "Module 0"
277~283	631~643	"Default CMD(3)(N)" data of "Module 1"
284~290	644~656	"Default CMD(3)(N)" data of "Module 2"
291~29D	657~669	"Default CMD(3)(N)" data of "Module 3"
29E~2AA	670~682	"Default CMD(3)(N)" data of "Module 4"
2AB~2B7	683~695	"Default CMD(3)(N)" data of "Module 5"
2B8~2C4	696~708	"Default CMD(3)(N)" data of "Module 6"
2C5~2D1	709~721	"Default CMD(3)(N)" data of "Module 7"
2D2~2DE	722~734	"Default CMD(3)(N)" data of "Module 8"
2DF~2EB	735~747	"Default CMD(3)(N)" data of "Module 9"
2EC~2F8	748~760	"Default CMD(3)(N)" data of "Module 10"
2F9~305	761~773	"Default CMD(3)(N)" data of "Module 11"
306~312	774~786	"Default CMD(3)(N)" data of "Module 12"
313~31F	787~799	"Default CMD(3)(N)" data of "Module 13"
320~32C	800~812	"Default CMD(3)(N)" data of "Module 14"
32D~339	813~825	"Default CMD(3)(N)" data of "Module 15"
[Module Error Record Data]		
33A~373	826~883	Module Error Record 1

INPUT DATA AREA		
MB_Addr (HEX)	MB_Addr (Decimal)	Description
374~3AD	884~941	Module Error Record 2
3AE~3E7	942~999	Module Error Record 3
[Default CMD(0&3) Status Data]		
3E8	1000	“Default CMD(0&3)” status of “Module 0”
3E9	1001	“Default CMD(0&3)” status of “Module 1”
3EA	1002	“Default CMD(0&3)” status of “Module 2”
3EB	1003	“Default CMD(0&3)” status of “Module 3”
3EC	1004	“Default CMD(0&3)” status of “Module 4”
3ED	1005	“Default CMD(0&3)” status of “Module 5”
3EE	1006	“Default CMD(0&3)” status of “Module 6”
3EF	1007	“Default CMD(0&3)” status of “Module 7”
3F0	1008	“Default CMD(0&3)” status of “Module 8”
3F1	1009	“Default CMD(0&3)” status of “Module 9”
3F2	1010	“Default CMD(0&3)” status of “Module 10”
3F3	1011	“Default CMD(0&3)” status of “Module 11”
3F4	1012	“Default CMD(0&3)” status of “Module 12”
3F5	1013	“Default CMD(0&3)” status of “Module 13”
3F6	1014	“Default CMD(0&3)” status of “Module 14”
3F7	1015	“Default CMD(0&3)” status of “Module 15”
3F8~419	1016~1049	Reserved
[User CMD Error Status Data]		
41A~44B	1050~1099	“User CMD(0~99)” error status
[Module Hardware Data]		
44C~44D	1100~1101	Module ID (“HART”)
44E~455	1102~1109	Module Name (16 Bytes)
456~459	1110~1113	Module Firmware Version (8 Bytes)
45A~47D	1114~1149	Reserved
[Through Mode Data]		

INPUT DATA AREA		
MB_Addr (HEX)	MB_Addr (Decimal)	Description
47E	1150L	Send count in through mode
47E	1150H	Receive count in through mode
47F	1151L	Receive error count in through mode
47F	1151H	Reserved
480	1152	Receive length in through mode
481~50E	1153~1294	Receive data in through mode
50F~513	1295~1299	Reserved
[Default CMD(3)(S) Data (FW_v1.5)]		
514~51D	1300~1309	“Default CMD(3)(S)” data of “Module 0”
51E~527	1310~1319	“Default CMD(3)(S)” data of “Module 1”
528~531	1320~1329	“Default CMD(3)(S)” data of “Module 2”
532~53B	1330~1339	“Default CMD(3)(S)” data of “Module 3”
53C~545	1340~1349	“Default CMD(3)(S)” data of “Module 4”
546~54F	1350~1359	“Default CMD(3)(S)” data of “Module 5”
550~559	1360~1369	“Default CMD(3)(S)” data of “Module 6”
55A~563	1370~1379	“Default CMD(3)(S)” data of “Module 7”
564~56D	1380~1389	“Default CMD(3)(S)” data of “Module 8”
56E~577	1390~1399	“Default CMD(3)(S)” data of “Module 9”
578~581	1400~1409	“Default CMD(3)(S)” data of “Module 10”
582~58B	1410~1419	“Default CMD(3)(S)” data of “Module 11”
58C~595	1420~1429	“Default CMD(3)(S)” data of “Module 12”
596~59F	1430~1439	“Default CMD(3)(S)” data of “Module 13”
5A0~5A9	1440~1449	“Default CMD(3)(S)” data of “Module 14”
5AA~5B3	1450~1459	“Default CMD(3)(S)” data of “Module 15”

OUTPUT DATA		
MB_Addr (HEX)	MB_Addr (Decimal)	Description
0~1F3	0~499	User command

OUTPUT DATA		
MB_Addr (HEX)	MB_Addr (Decimal)	Description
1F4	500L	Reset module state function
1F4	500H	Reserved
1F5	501L	Auto Polling function
1F5	501H	Reserved
1F6	502L	Output Trigger function
1F6	502H	The index of trigger command
1F7~1F9	503~505	Reserved
1FA~76B	506~1899	Reserved (For Module Configuration)
76C	1900L	Channel selection in through mode
76C	1900H	Reserved
76D	1901	Send data length in through mode
76E~7FB	1902~2043	Send data in through mode

[Note]

(1) MB=Modbus, CMD=Command, MOD=Module, DEV=Device

(2) 500L: The low byte of MB_Addr 500.

500H: The high byte of MB_Addr 500

(3) Default CMD(num)(format):

[1] Num: means HART command number. When add a new HART device in module, these two default commands – “Default CMD(0)” and “Default CMD(3)” will be produced automatically.

[2] Format: means the format of HART command of HRT-7(3)10.

<1> Normal format (N): Use the standard HART command format.

<2> Simple format (S): Refer to “Appendix B: Command Format”.

(4) The description of the “Default CMD(0 & 3)” status:

It consists of two bytes. The first byte is the state of “Default CMD(0)” and the second byte is the state of “Default CMD(3)”.

Ex: If the value is 0x0100 for the MB address 1000, then the 1000L is 0x00 and the 1000H is 0x01. It means the error status of “Default CMD(0)” is 0x00 and the error status of “Default CMD(3)” is 0x01 in “Module 0”.

(5) The description of the User CMD status:

The maximum number of "User CMD" is 100 (0~99). The MB address range for the error status of these User CMD is 1050~1099. It means that one MB address represents two User CMD states.

Ex: If the value is 0x0200 for the MB address 1050, then the 1050L is 0x00 and the 1050H is 0x02. It means the error status of "User CMD Index 0" is 0x00 and the error status of "User CMD Index 1" is 0x02.

(6) Module state machine:

- 0 — IDLE.
- 1 — Waits to send HART command.
- 2 — It is sending HART command.
- 3 — Waits to receive HART data.
- 4 — It is reading HART data.

(7) Module error status:

- 0 — No error
- 1 — Means the command has never be executed
- 2 — Receive timeout, can't receive any HART data
- 3 — Receive HART data is too short
- 4 — The delimiter of HART data has some error
- 5 — The address (the bit of master type) of HART data has some error
- 6 — The address (the bit of burst mode) of HART data has some error
- 7 — The command of HART data has some error
- 8 — The parity of HART data has error.
- 9 — The communication with HART slave device has some error and The error messages are recorded in the responses codes.

(8) Module error command index:

The index value indicates the latest error user command number. If the value is 255, it means no any error command happened.

(9) Module error record:

When the HART comm. error happened, HRT-7(3)10 will record the error information and it provides 3 records. The format of the error record is as below:

- Byte 0: The length of send data (1 Byte)
- Byte 1~53: The record of send data (Max. 53 Bytes)
- Byte 54: The length of receive data (1 Byte)

Byte 55~109: The record of receive data (Max. 55 Bytes)

Byte 110~113: The time stamp record (4 Bytes)

Byte 114~115: Reserved (2 Bytes)

(10) Module status reset function:

When set the value is bigger than zero, the module will clear “module request count”, “module response count”, “module error count”, “module error status” and set “module error command index” to 255.

(11) Auto Polling function:

When set the value to be 1, the module will execute all HART polling commands automatically.

(12) Output Trigger function:

If change the value, the module will refer to the index value (0~99, 255 is for through mode) of trigger command to execute the corresponding user command.

Ex: If the index of trigger command is 0 and the output trigger function value is 1, when change the value of output trigger function from 1 to 2, the module will execute the user command (index = 0).

(13) Default CMD(3)(S) Data: (FW_v1.5)

By using the address, users do not need to add the simple format of User CMD(3). Just do the below setting, then HMI or SCADA can get the HART Cmd(3) data easily.

[1] Set "Default CMD(3) mode" to "Polling".

[2] Set "Swap mode" to "W&B".

[3] Run "Save to Device" function.

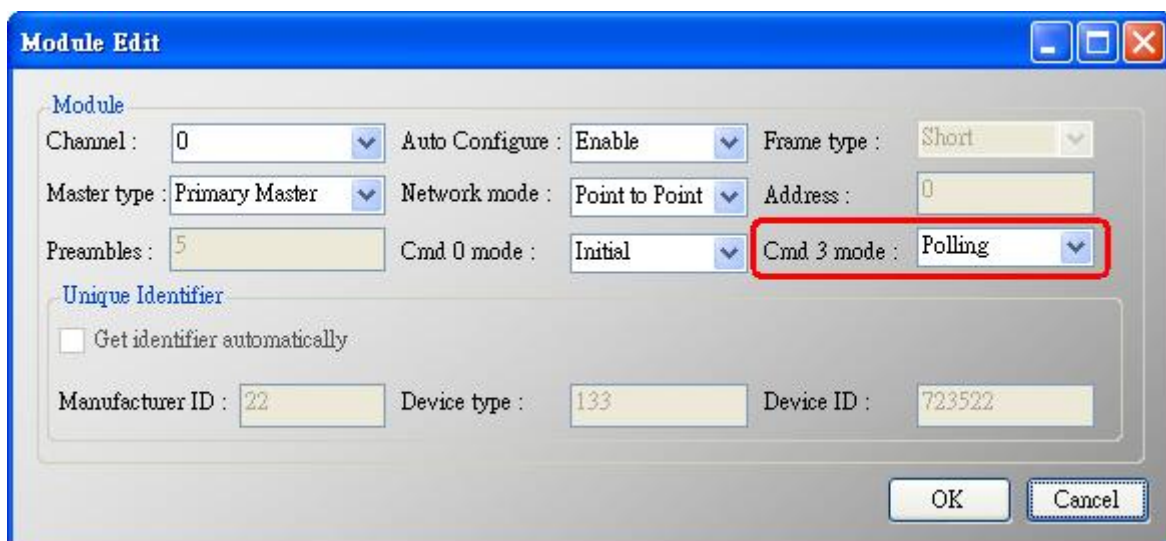

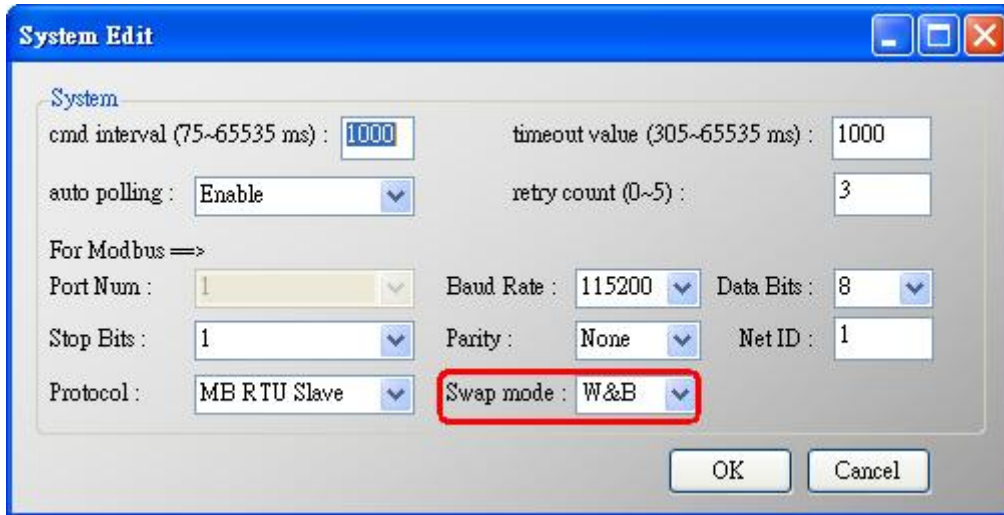

4.3 Diagnostic Messages

Please refer to section 4.3 - Modbus / HART Mapping Table. The related MB address is shown as below.

Input Data Area	Description
500~502	Module state data
826~883	Module error record data
1000~1015	“Default CMD(0&3)” status data
1050~1099	“User CMD(0~99)” error status

4.4 Through Mode

In this mode, users can send and receive the HART command directly. Please refer to the below steps.

Step 1: Set the “Channel” to 0. (Through Mode just support channel 0)

[MB:1900L]

Step 2: Set the “Send length”. [MB:1901]

Step 3: Set the “HART command data”. [MB: 1902~2043]

Ex: 0xFF 0xFF 0xFF 0xFF 0xFF 0x02 0x80 0x00 0x00 0x82

Step 4: Set the “Auto Polling” to 0. [MB:501L]

(In this mode, “Auto Polling” function can’t be enabled.)

Step 5: Set the “The index of trigger command” to 255. [MB:502H]

Step 6: Get the receive count from “Receive count in through mode” [MB:1150H] and error count from “Error count in through mode” [MB:1151L].

Step 7: Change the “Output Trigger function” value. [MB:502L]

Step 8: Get the value of “Receive count in through mode” and “Error count in through mode” until one of them is different than the last value.

Step 9: If the “Receive count in through mode” is different than the last value, the user can get the receive length from “Receive length in through mode” and the user can get receive data from “Receive data in through mode” [MB:1153 ~] according to receive data length.

[MB:1152]

If the “Error count in through mode” is different than the last value, it means it can’t receive any data.

4.5 Data Exchange Example

In this example, use ICP DAS MB/RTU master tool

(Download from: (http://ftp.icpdas.com.tw/pub/cd/8000cd/napdos/modbus/modbus_utility/)) to send the HART command 0 and receives the hardware information of HART slave via the HRT-7(3)10 gateway.

Step 1: Please connect the PC、HRT-7(3)10 and HART Slave device.

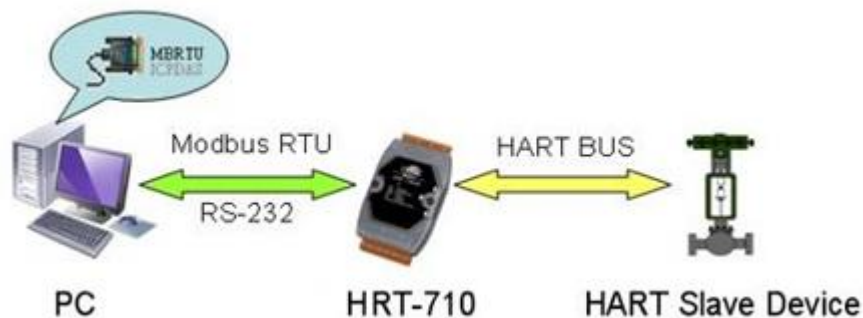

Figure 21: Hardware connection

Step 2: Set the module to the default settings.

- (1)HRT-710: Set the DIP switch in the backplane of HRT-710 to the “default” position.
- (2)HRT-310: Set the “Default” dip switch to be “ON” position.

Please reboot the module and the default settings are as below.

Item	Value
Baud rate	115200 bps
Date bits	8 bits
Stop bits	1 bit
Parity	None
Net ID (Modbus ID)	1
Protocol	Modbus RTU Slave

Step 3: Waiting for the “RUN” LED of HRT-7(3)10 to be always on.

Step 4: Run the MB/RTU tool (like Figure 22) on PC.

- (1) Set the PC COM port number
- (2) Set the baud rate to 115200
- (3) Set the Line control to “N,8,1”
- (4) Click “Open” button

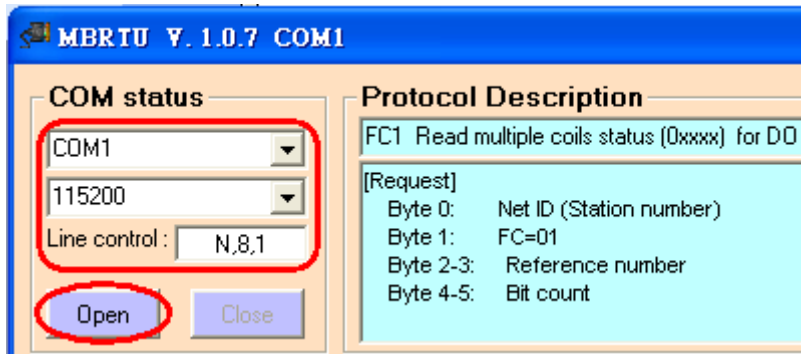

Figure 22: MB/RTU Tool

Step 5: Send the Modbus command : 0x01 0x04 0x01 0xFA 0x00 0x07 0x90 0x05 [MB: 0x1FA~0x200, total word length is 7.]

Step 6: Receive and analyze the response data.

Here are the Modbus response data:

0x01 0x04 0x0E 0x10 0x00 0x3F 0xFE 0x08 0x04 0x01 0x05 0x1B 0x10 0x1B 0x00 0xE8 0x97 0x33 0xCC

The HART data is 7 Words (14 Bytes) as below:

Word 0: 0x10 (Byte 1) 0x00 (Byte 0)

Word 1: 0x3F (Byte 3) 0xFE (Byte 2)

Word 2: 0x08 (Byte 5) 0x04 (Byte 4)

Word 3: 0x01 (Byte 7) 0x05 (Byte 6)

Word 4: 0x1B (Byte 9) 0x10 (Byte 8)

Word 5: 0x1B (Byte 11) 0x00 (Byte 10)

Word 6: 0xE8 (Byte 13) 0x97 (Byte 12)

The HART command 0 format is 2 bytes response code and 12 bytes data.

[Response code1]

Byte 0: 0x00 → means “No Error”

[Response code2]

Byte 1: 0x10 → means “More Status Available”

[Response data bytes of command 0]

Byte 2: 0xFE → Constant value

Byte 3: 0x3F → Manufacturer ID, 0x3F = “Eckardt”

Byte 4: 0x04 → Manufacturer’s device ID

Byte 5: 0x08 → Number of preambles needed in the request

Byte 6: 0x05 → Command set revision number

Byte 7: 0x01 → Transmitter specific revision code

- Byte 8: 0x10 → Software revision
- Byte 9: 0x1B → Hardware revision
- Byte 10: 0x00 → Flags
- Byte 11~13: 0x1B 0x97 0xE8 → Device ID number

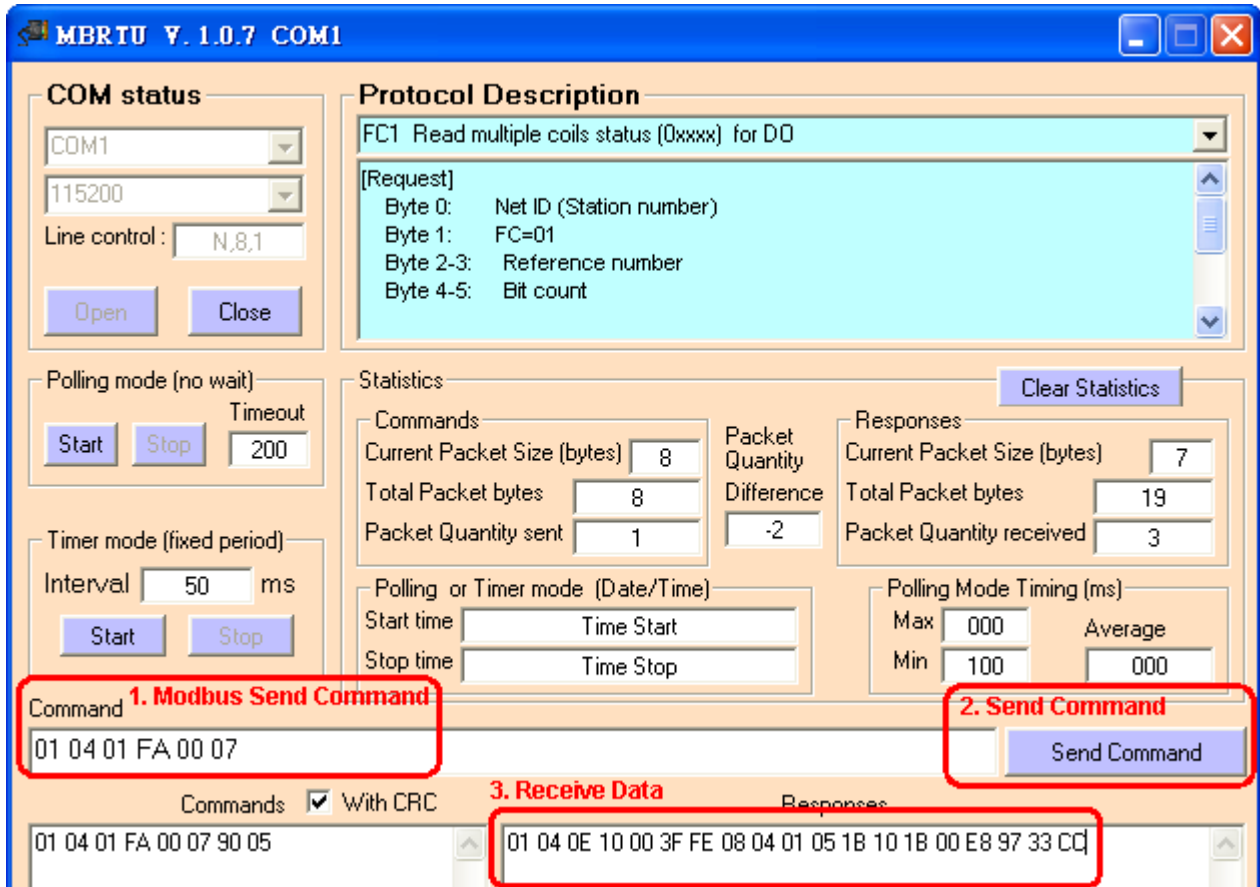

Figure 23: Modbus RTU send and receive data

5. HG_Tool Application

5.1 Install .NET Compact Framework

It needs the runtime environment with .NET Framework 2.0 or above to execute the HG_Tool in PC. If .NET Framework 2.0 or above exists in PC, the section 5.1 can be omitted.

- ◆ Microsoft .Net Framework Version 2.0:

<http://www.microsoft.com/downloads/details.aspx?FamilyID=0856eacb-4362-4b0d-8edd-aab15c5e04f5&DisplayLang=en>

- ◆ Microsoft .Net Framework Version 3.5:

<http://www.microsoft.com/downloads/details.aspx?familyid=333325FD-AE52-4E35-B531-508D977D32A6&displaylang=en>

The install steps are shown in the below:

- ◆ Press “Next” to the next step.

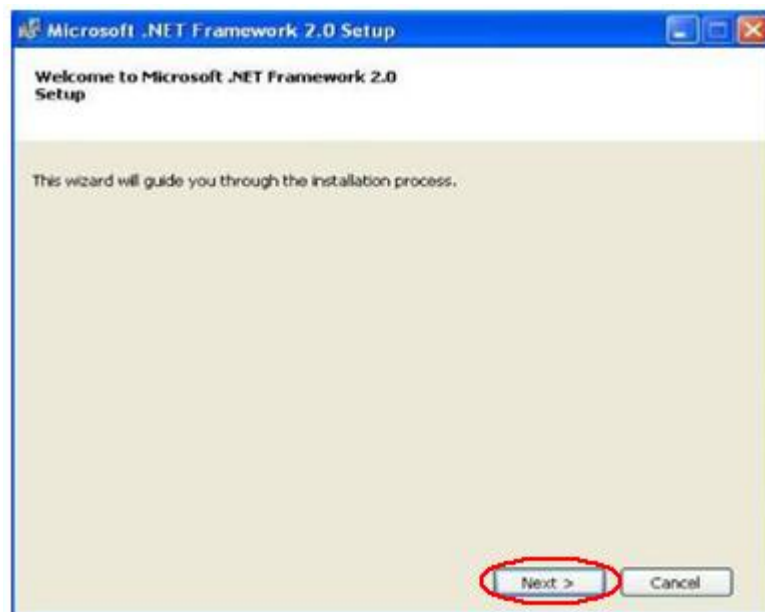

Figure 24: Install .NET Framework—Step1

- ◆ Select the “I accept the terms of the License Agreement” and click “Install” button.



Figure 25: Install .NET Framework—Step2

◆ After finishing the installation, press “Finish” button to exit.

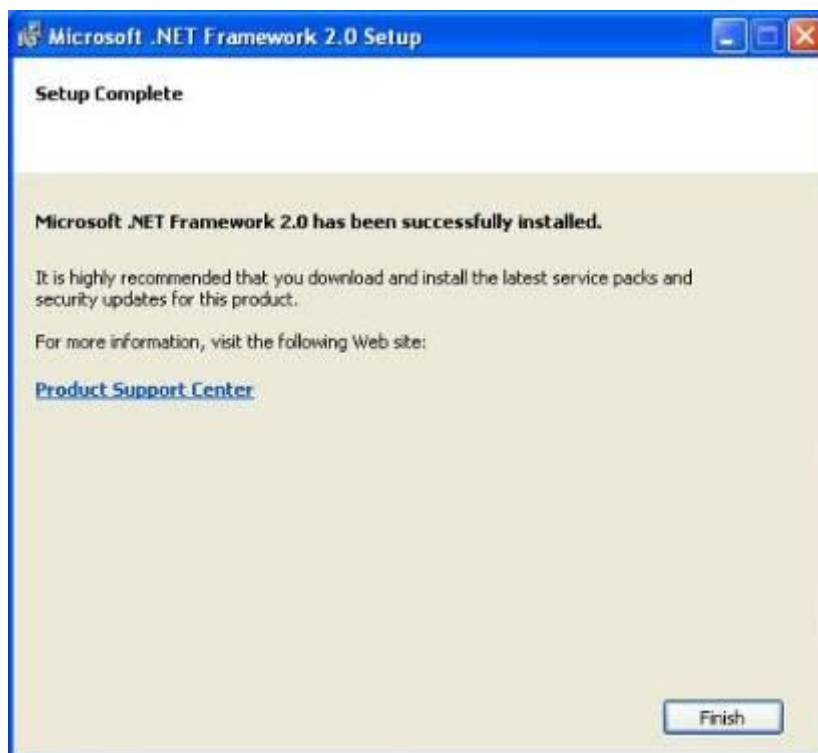

Figure 26: Install .NET Framework—Step3

5.2 Install HG_Tool

Step 1 : Download the installation file of “HG_Tool” from the CD-ROM disk

(“CD:\hart\gateway\utilities\hg_tool”) or the web site

[“ftp://ftp.icpdas.com.tw/pub/cd/fieldbus_cd/hart/gateway/utilities/hg_tool/”](ftp://ftp.icpdas.com.tw/pub/cd/fieldbus_cd/hart/gateway/utilities/hg_tool/)

Step 2 : Execute the Setup.exe file to install the “HG_Tool” Utility.



Figure 27: Install the utility

Step 3 : Click the “Next” button to continue. If you want to change the installation destination, click “Browse” button to set the installation path.



Figure 28: Set the installation path

Step 4 : Click the “Next” button to confirm installation

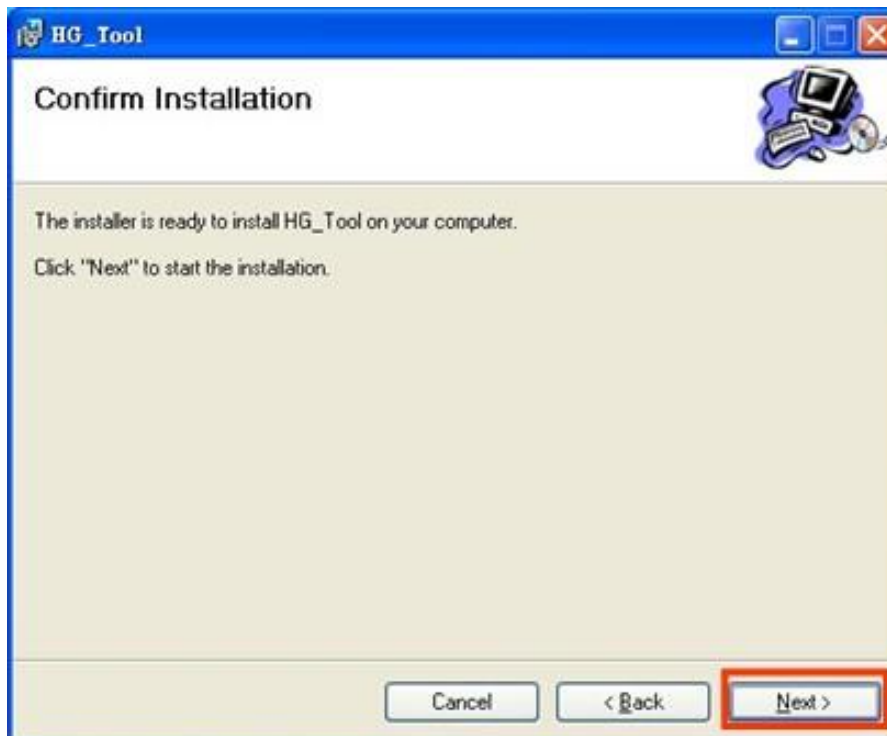

Figure 29: Confirm installation

Step 5 : Click the “Close” button to finish and exit the installation program

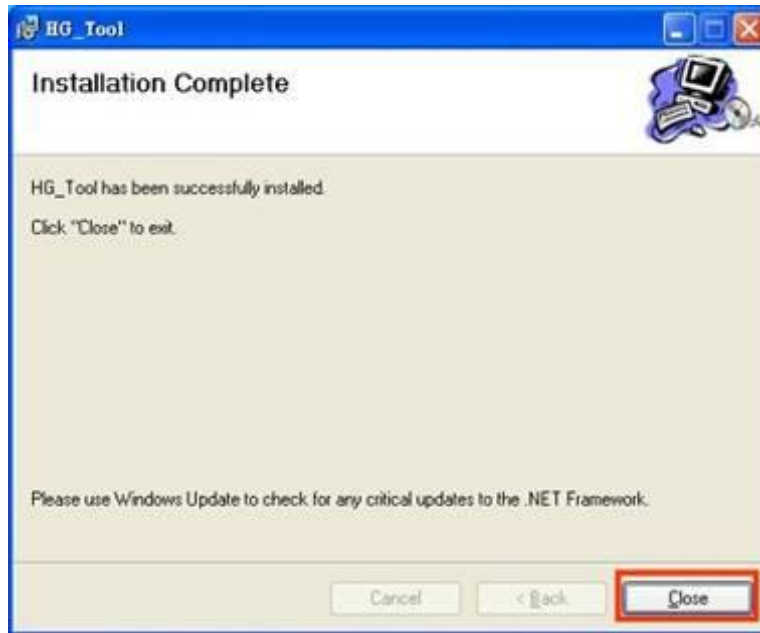

Figure 30: Installation completion

Step 6 : After finishing the installation of the HG_Tool, users can find the utility as shown in the following screen shot.



Figure 31: The path of HG_Tool

5.3 HG_Tool Utility

The main window of HG_Tool utility is shown as Figure 32.





Figure 32: Main window of the utility

The main window of the HG_Tool has 4 parts as below:



- (1) Traffic Light
- (2) Connection Status
- (3) Connection Control
- (4) Tools

5.3.1 Traffic Light

1.  => The com port of PC has not be opened yet.
2.  => The com port of PC is open and try to connect to HRT-7(3)10.
3.  => The PC connect to HRT-7(3)10 successfully.

5.3.2 Connection Status

1.  =>The com port of PC has not be opened.

2.  => The com port of PC is open and try to connect to module.
3.  => The PC connect to HRT-7(3)10 successfully.

5.3.3 Connection Control

1. **“Connect”** button:

When clicking this button, the PC will open the com port and try to connect to HRT-7(3)10 module.

2. **“Disconnect”** button:

When clicking this button, the PC will break the connection of the HRT-7(3)10 and close the com port.

5.3.4 Tools

The HG_Tool includes 9 parts as below :

- (1) Communication Settings
- (2) Device Information
- (3) Device Configuration
- (4) Default Output Data
- (5) Address Map
- (6) Device Diagnostic
- (7) Through Mode
- (8) Format Translation
- (9) About

5.3.4.1 Communication Settings

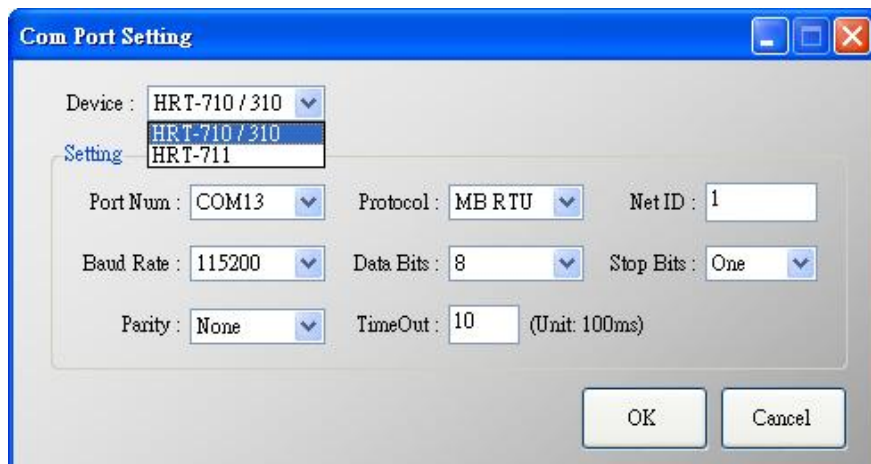

Figure 33: The window of communication settings

It is used to set the PC communication parameters. These settings must be the same as HRT-7(3)10 module's.

- (1)Device : Choose the module type of HART Gateway
(HG_Tool_v1.5.0 or newer supported)
- (2)Port Num : Com 1~ Com 255
- (3)Protocol : MB RTU or MB ASCII (MB = Modbus)
- (4)Net ID : 1~247
- (5)Baud Rate : 1200~115200 bps
- (6)Data Bits : 7/8 bits
- (7)Stop Bits : 1/2 bits
- (8)Parity : None / Odd / Even
- (9)Timeout : 1~255 (HG_Tool_v1.4.3 or newer supported)

5.3.4.2 Device Information

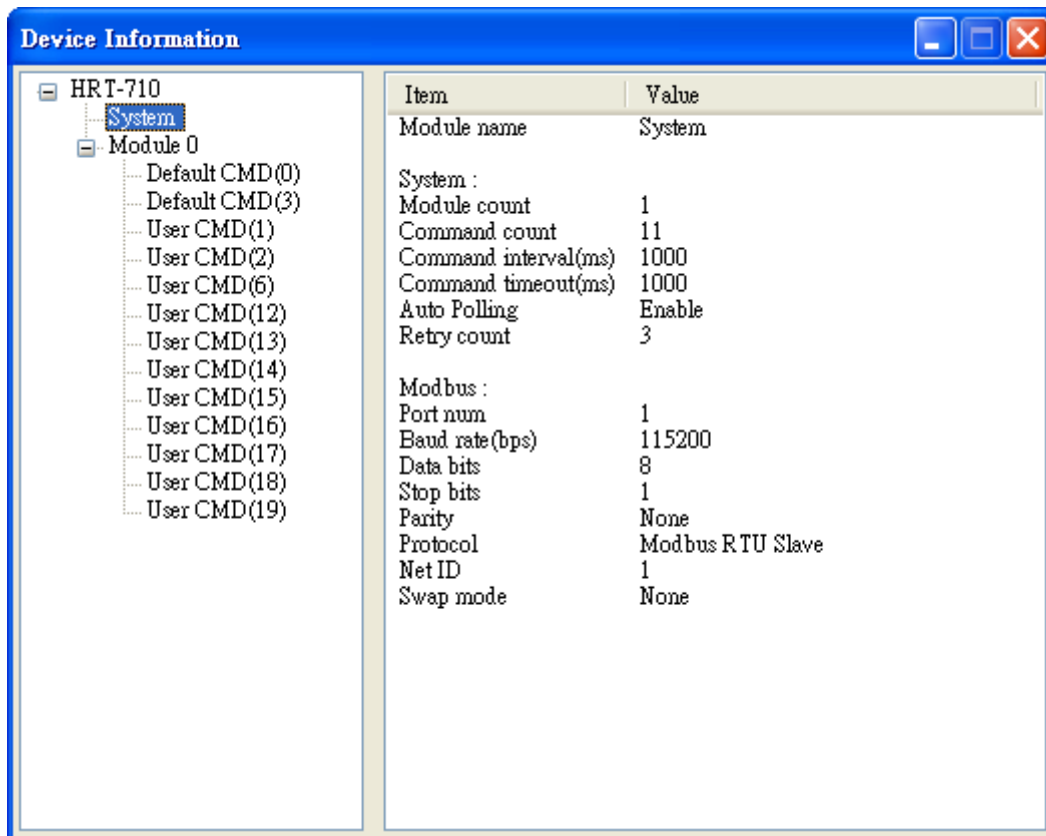

Figure 34: The window of device information

It shows the configuration of the HRT-7(3)10 module. When clicking the left item, it will show the item data in the right side. About the data of these items is shown as Table 6.

[Table 6: The data of the node]

Node	Behavior	Data
HRT-710	click	Module name: HRT-710 / HRT-310 Firmware version: V01.5
System	click	Module name: System [System:] Module count: 0~16 Command count: 0~100 Command interval (ms): 75~65535 Command timeout (ms): 305~65535 Auto Polling: Enable/Disable Retry count: 0~5 [Modbus:] Port num: 0~3 Baud rate (bps): 1200~115200 Data bits: 7/8 Stop bits: 1/2 Parity: None/Odd/Even Protocol: Modbus RTU Slave /Modbus ASCII Slave Net ID: 1~247 Swap mode: None, Byte, Word, W&B
System	right click	Include the below two options: 1. Basic Operation: Read/Write module information by using window option. 2. Advanced Operation: Read/Write module information by using address mapping.
Module	click	Module name: Module Channel: 0 Auto Configuration: Enable/Disable Network: Point to Point / Multi-drop (Preamble length: 5~20) (Master type: Primary/Secondary Master) (Frame type: Short/Long Frame) (Module address: 0~15) (Auto Get Unique ID: Enable/Disable) (Manufacturer ID: 1 byte) (Device type: 1 byte) (Device ID: 3 bytes) Default Command(0): Disable/Initial/Polling Default Command(3): Disable/Initial/Polling
Default CMD	click	Module name: Default CMD Module index: 0~15 Command num: 0~255 Command mode: Initial/Polling Command format: Normal/Simple Command in size: 2~255 Command out size: 0~255 Command in address Command out address
Default CMD	right click	Include the below two options: 1. Basic Operation:

Node	Behavior	Data
		Read/Write the Default CMD data by using window option. 2. Advanced Operation: Read/Write the Default CMD data by using address mapping.
User CMD	click	Module name: User CMD Module index: 0~15 User command index: 0~99 Command num: 0~255 Command mode: Initial/Polling/Manual Command format: Normal/Simple Command in size: 2~255 Command out size: 0~255 Command in address Command out address
User CMD	right click	Include the below two options: 1. Basic Operation: Read/Write the User CMD data by using window option. 2. Advanced Operation: Read/Write the User CMD data by using address mapping.

1. The “Basic Operation” of System item :

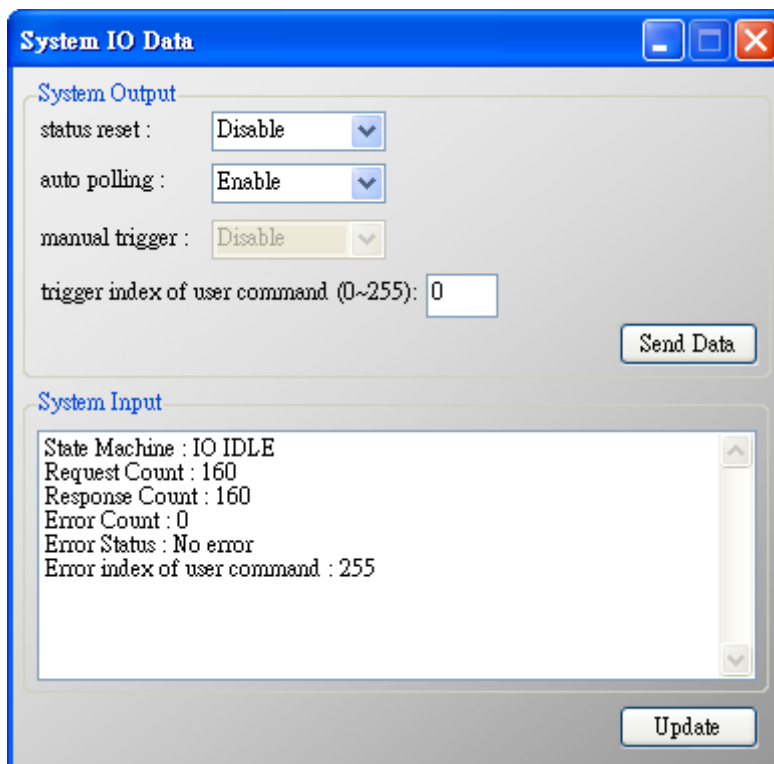

Figure 35: The system window of basic operation

(1) System Output:

[1] status reset:

When set the item to “Enable”, the module will clear “module request count”, “module response count”, “module error count”, “module error status” and set “module error command index” to 255.

[2] auto polling:

When set the item to “Enable”, the module will execute all HART polling commands automatically.

[3] manual trigger:

When set the item to “Enable”, the module will execute the user command once according to the value of “trigger index of user command” field.

[4] trigger index of user command:

If users want to execute user command by manual mode, users must set the index value first.

[5] “Send Data” button:

When click the button, it will update data in the “System Output” area to HRT-7(3)10 module.

(2) System Input:

[1] State Machine:

It will show the state machine of HRT-7(3)10 module.

[2] Request Count (0~255):

It will show the request count of HART UserCmd.

[3] Response Count (0~255):

It will show the response count of HART UserCmd.

[4] Error Count (0~255):

It will show the response error count of HART UserCmd.

[5] Error Status:

It will show the error status of HART UserCmd.

[6] Error index of user command:

It will show the latest HART UserCmd that has error happened. If the index value is 255, it means no error happened.

[7] “Update” button:

When click the button, it will update “System Input” data from the HRT-7(3)10 module.

2. The “Advanced Operation” of System item :

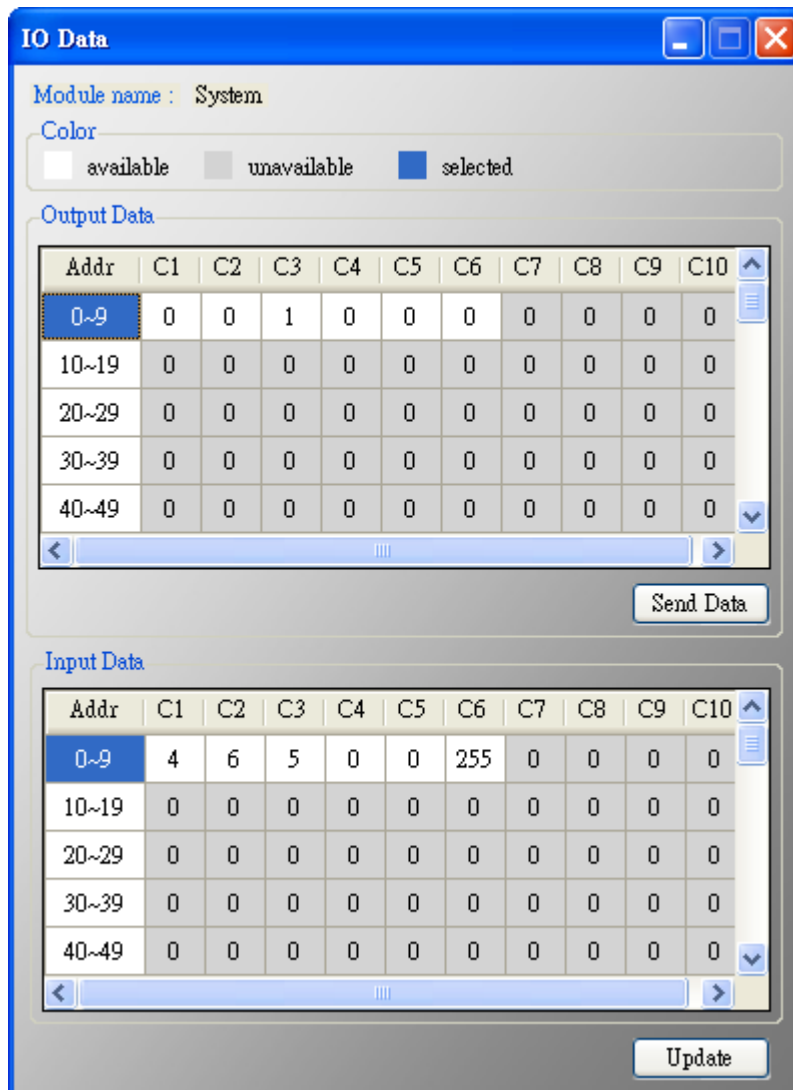

Figure 36: The system window of advanced operation

(1) Output Data:

It has 6 bytes data. When click the “Send Data” button, it will send the output data to HRT-7(3)10. (MB_Addr: 500~502 in Output Data Area)

(2) Input Data:

It has 6 bytes data. When click the “Update” button, it will update the data from HRT-7(3)10. (MB_Addr: 500~502 in Input Data Area)

3. The “Basic Operation” of “Default/User CMD” item :

In the function, only supports HART command 0, 1, 2, 3, 6, 11, 12, 13, 14, 15, 16, 17, 18, 19 and the different HART command will show the different user command window (EX: The window of HART command 0 and 6 is shown as below).

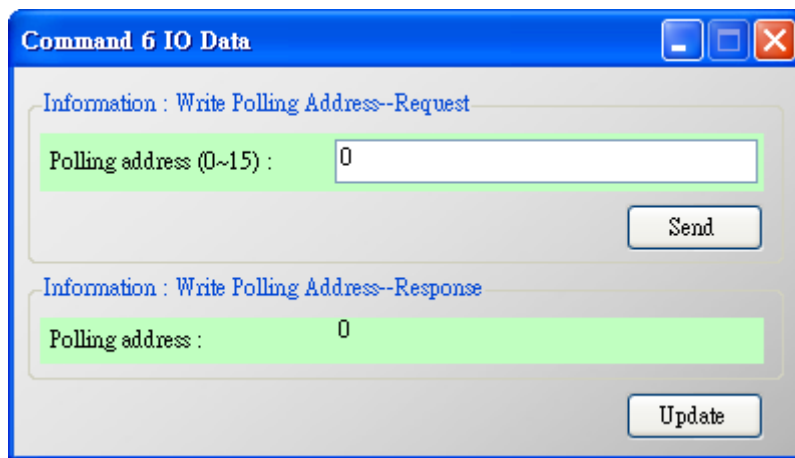
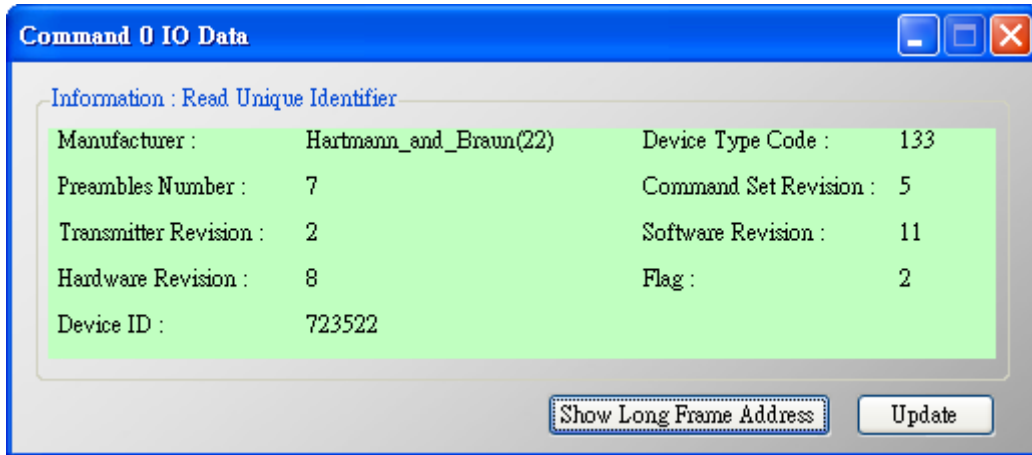

Figure 37: The user command window of basic operation

(1) "Send" button:

When click the button, it will send the output data to HRT-7(3)10 but the output data will not be sent from HART channel of HRT-7(3)10. If users want to send the output data to HART device, please refer to the "manual trigger" operation.

(2) "Update" button:

When click the button, it will update the input and output data from HRT-7(3)10 module.

4. The "Advanced Operation" of "Default/User CMD" item :

Users can read/write HART command data via address mode.

[Note]

About the "Input data" area of user command, the first 2 bytes are response code1 and code2 of HART command and the left bytes are the HART command data.

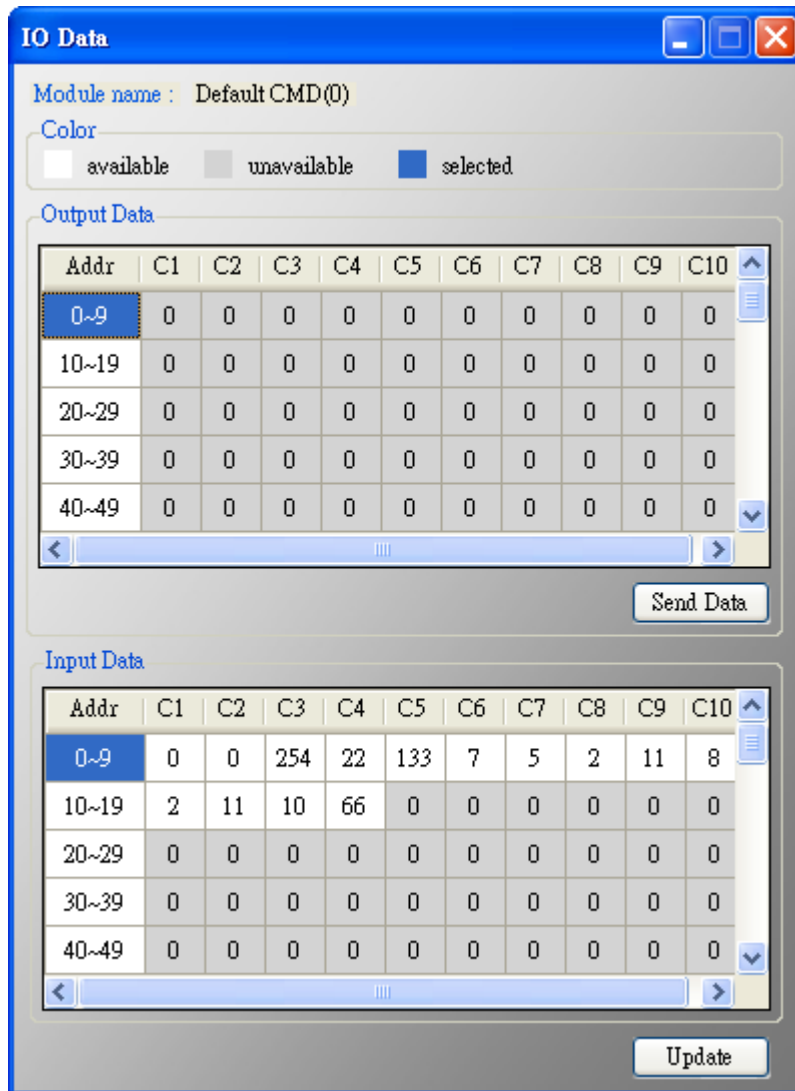

Figure 38: The user command window of advanced operation

(1) "Send Data" button:

When click the button, it will send the output data to HRT-7(3)10.

(2) "Update" button:

When click this button, it will update the input and output data from HRT-7(3)10.

5.3.4.3 Device Configuration

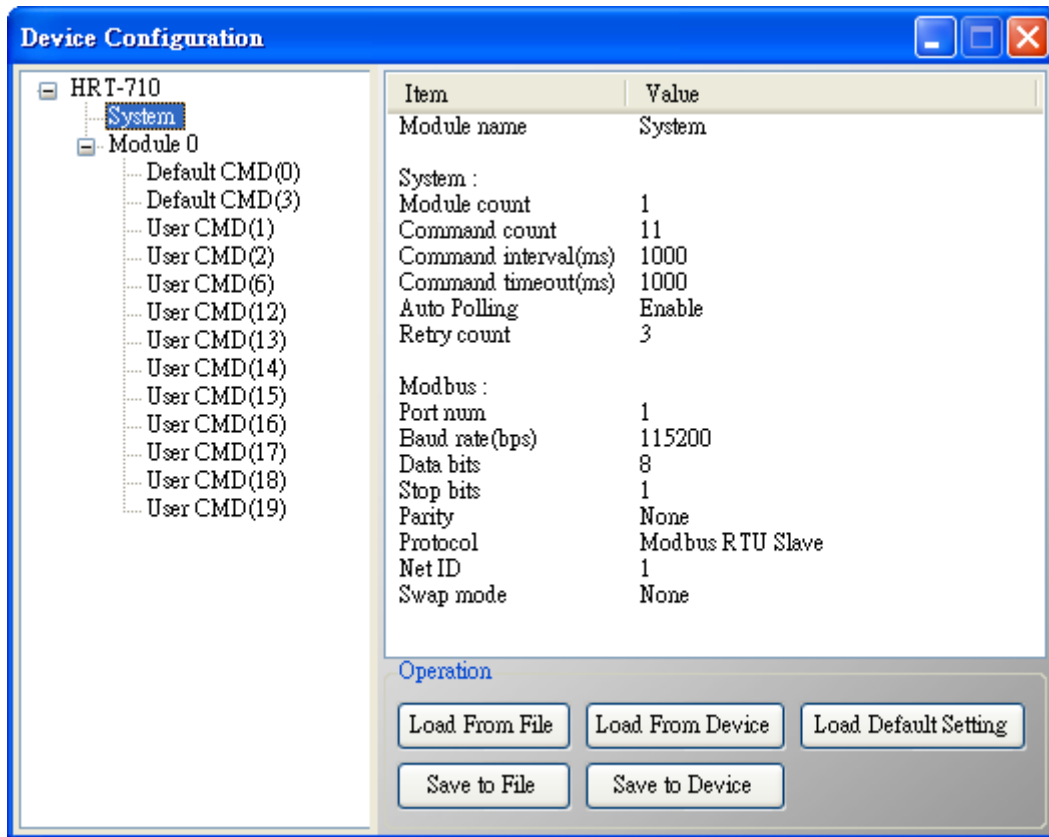

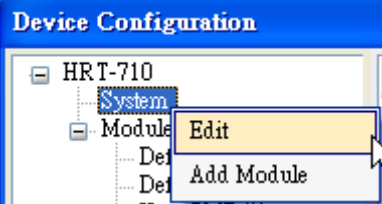
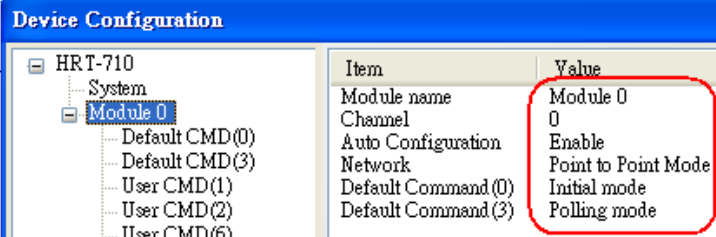
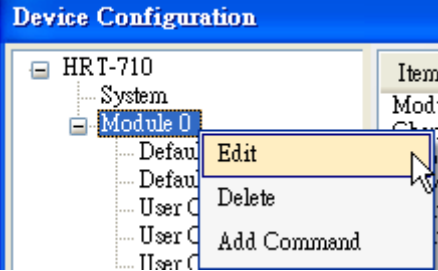

Figure 39: The window of device configuration

It will show the system configuration of HRT-7(3)10 and users can also configure module here. When click the left item, it will show the corresponding item information in the right side of window. The following is detailed description.

[Table 6: The data of the node]

Node	Behavior	Data
HRT-710	click	Module name Firmware version 
System	click	Module name: System [System:] Module count: 0~16 Command count: 0~100 Command interval (ms): 75~65535 Command timeout (ms): 305~65535 Auto Polling: Enable/Disable Retry count: 0~5 [Modbus:] Port num: 0~3

Node	Behavior	Data														
		Baud rate (bps): 1200~115200 Data bits: 7/8 Stop bits: 1/2 Parity: None/Odd/Even Protocol: Modbus RTU Slave / Modbus ASCII Slave Net ID: 1~247 Swap mode: None, Byte, Word, W&B														
System	right click	 <p>Include the below two options:</p> <ol style="list-style-type: none"> 1. Edit: Configure the Modbus and HART comm. settings of HRT-7(3)10. 2. Add Module: Add new HART device in HRT-7(3)10. 														
Module	click	 <table border="1" data-bbox="981 1019 1364 1198"> <thead> <tr> <th>Item</th> <th>Value</th> </tr> </thead> <tbody> <tr> <td>Module name</td> <td>Module 0</td> </tr> <tr> <td>Channel</td> <td>0</td> </tr> <tr> <td>Auto Configuration</td> <td>Enable</td> </tr> <tr> <td>Network</td> <td>Point to Point Mode</td> </tr> <tr> <td>Default Command(0)</td> <td>Initial mode</td> </tr> <tr> <td>Default Command(3)</td> <td>Polling mode</td> </tr> </tbody> </table> <p>Module name: Module Channel: 0 Auto Configuration: Enable/Disable Network: Point to Point / Multi-drop (Preamble length: 5~20) (Master type: Primary/Secondary Master) (Frame type: Short/Long Frame) (Module address: 0~15) (Auto Get Unique ID: Enable/Disable) (Manufacturer ID: 1 byte) (Device type: 1 byte) (Device ID: 3 bytes) Default Command(0): Disable/Initial/Polling Default Command(3): Disable/Initial/Polling</p>	Item	Value	Module name	Module 0	Channel	0	Auto Configuration	Enable	Network	Point to Point Mode	Default Command(0)	Initial mode	Default Command(3)	Polling mode
Item	Value															
Module name	Module 0															
Channel	0															
Auto Configuration	Enable															
Network	Point to Point Mode															
Default Command(0)	Initial mode															
Default Command(3)	Polling mode															
Module	right click	 <p>Include the below three options:</p>														

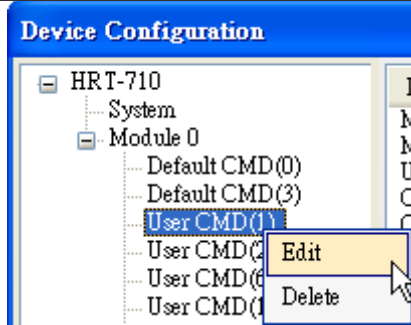
Node	Behavior	Data
		<ol style="list-style-type: none"> 1. Edit: Configure the comm. settings of the HART device. 2. Delete: Delete the HART device. 3. Add Command: Add new HART command for the HART device.
Default CMD	click	Module name: Default CMD Module index: 0~15 Command num: 0~255 Command mode: Initial/Polling Command format: Normal/Simple Command in size: 2~255 Command out size: 0~255 Command in address Command out address
User CMD	click	Module name: User CMD Module index: 0~15 User command index: 0~99 Command num: 0~255 Command mode: Initial/Polling/Manual Command format: Normal/Simple Command in size: 2~255 Command out size: 0~255 Command in address Command out address
User CMD	right click	 <p>Include the below two options:</p> <ol style="list-style-type: none"> 1. Edit: Configure the comm. settings of the User CMD. 2. Delete: Delete the HART User CMD.

1. "System Edit" window:

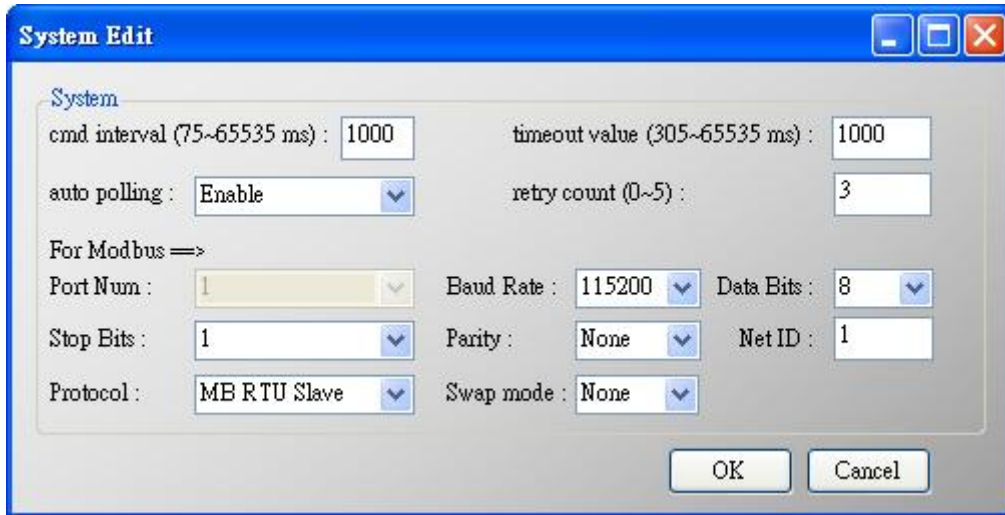

Figure 40: The “System Edit” window

It is used to set the comm. parameters of HART and Modbus.

(1) cmd interval (75~65535 ms): The polling interval of HART Cmd.

EX: HART Cmd 1 request → HART Cmd1 response → wait (cmd interval) → HART Cmd 2 request → HART Cmd 2 response → wait (cmd interval) → ...

(2) timeout value (305~65535 ms): The timeout value of HART Cmd.

(3) Auto polling: If the function is enabled, HRT-7(3)10 will execute all HART polling Cmd automatically.

(4) Retry count (0~5): When HART comm. error happened, HRT-710 will re-send the HART Cmd for “Retry count” times.

(5) The following are the Com Port comm. setting of HRT-7(3)10.

[1] Baud Rate: 1200~115200 bps.

[2] Data Bits: 7 or 8.

[3] Stop Bits: 1 or 2

[4] Parity: None / Odd / Even.

[5] Net ID: 1~247.

[6] Protocol: MB RTU Slave or MB ASCII Slave.

[7] Swap mode: None / Byte / Word / W&B (The swap mode of Modbus comm.)

EX: 2 words data (0x1234, 0x5678) from HRT-710. Users can set the swap mode for different data format.

Swap mode	Data
None	0x1234 0x5678
Byte	0x3412 0x7856

Swap mode	Data
Word	0x5678 0x1234
W&B	0x7856 0x3412

2. “Module Edit” window:

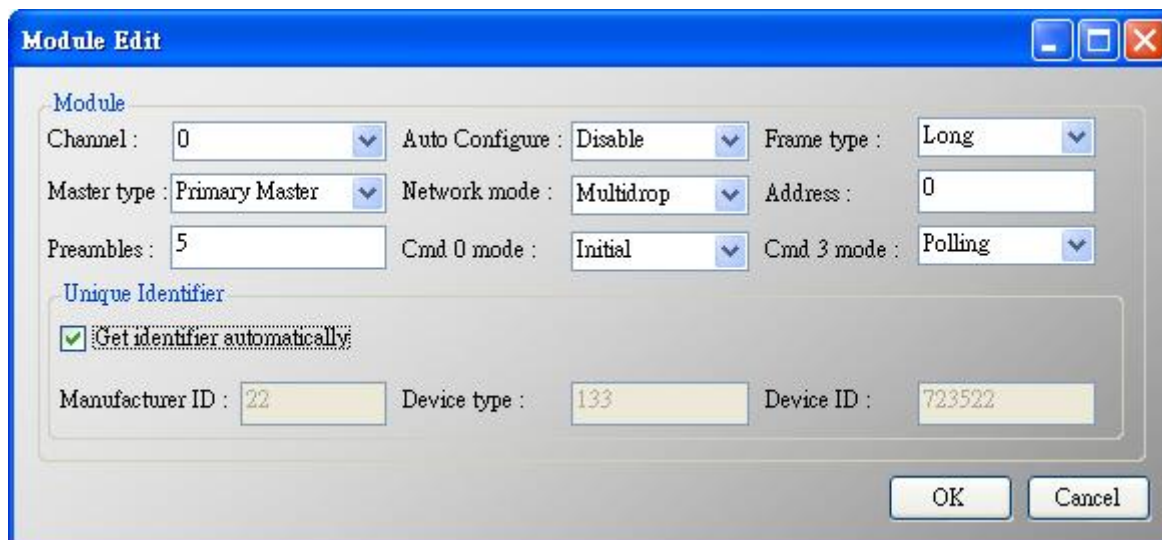

Figure 41: The “Module Edit” window

It is used to set the comm. mode for HART devices.

- (1) Channel: 0~7. (Only channel 0 supports now)
- (2) Auto Configure: If enables this function, HRT-7(3)10 will detect the “frame type”, “address”, “preambles”, “manufacturer ID”, “device type” and “device ID” of HART device automatically.

[Note] If enables this function, just supports HART “Point to Point” mode.

- (3) Frame type: Short or Long frame.
- (4) Master type: Primary or Secondary Master.

[Note] In general, HRT-7(3)10 should be the “Primary Master”.

- (5) Network mode: “Point to Point” or “Multi-drop” mode.

Note :

[1] “Point to Point”: Only one HART slave device in HART bus.

[2] “Multi-drop”: More than one HART devices can be in HART bus.

- (6) Address: 0~15.

Note :

[1] If the address of HART device is 0, it means in the “Point to Point” mode.

[2] If the address of HART device is between 1 and 15, it means in the “Multi-Drop” mode.

- (7) Preambles: 5~20.
- (8) Get identifier automatically: If the frame type of HART slave device is long frame, users can enable this function to get unique ID automatically by short frame address.
- (9) Manufacturer ID: Users can set the manufacturer ID for HART device. If the frame type is “short”, users can omits this setting.
- (10) Device type: Users can set the device type for HART device. If the frame type is “short”, users can omits this setting.
- (11) Device ID: Users can set the device ID for HART device. If the frame type is “short”, users can omits this setting.
- (12) Cmd 0 mode: Disable / Initial / Polling.
- (13) Cmd 3 mode: Disable / Initial / Polling.

Disable: module will not execute the default HART Cmd.

Initial: module will execute the default HART Cmd automatically when in “Initial” mode.

Polling: module will execute the default HART Cmd automatically when in “Operation” mode.

3. “User CMD Edit” window:

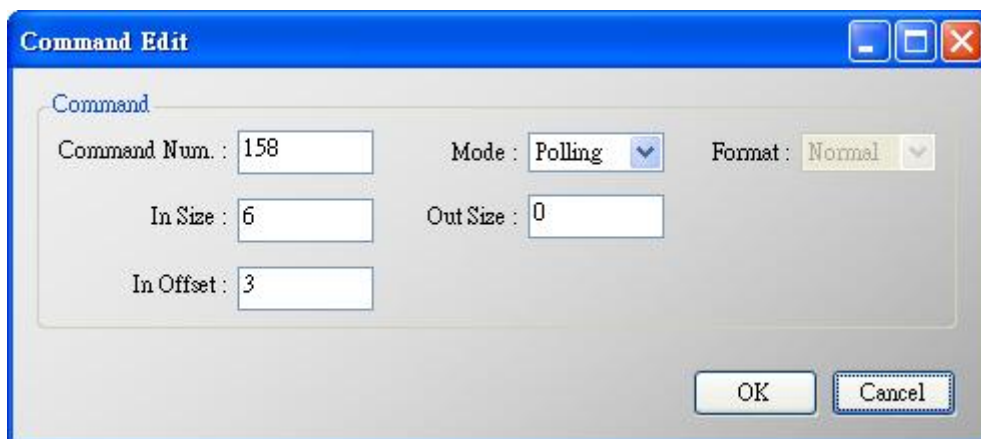

Figure 42: The command window

It is used to set the comm. parameter for HART User CMD.

- (1) Command Num.: Set the HART command number.
- (2) Mode: Initial / Polling / Manual.
 - Initial: The module will run this command in initial mode.
 - Polling: The module will run this command in operation mode.
 - Manual: The module will run this command by manual.
- (3) Format: Normal / Simple. (Data exchange format between HART and Modbus)

- [1] Normal: When read / write HART data by Modbus, the data format is HART standard command format.
- [2] Simple: When read / write HART data by Modbus, the data format is simple format defined by HRT-7(3)10. The detailed description, please refer to the appendix B - command format. (In this mode, the HMI or SCADA software can read or write HART data and don't need to process any data. Now, it is only supported HART command number: 1, 2 and 3.)
- (4) In Size: Set the input data length of HART returned command data.
 Note: The size includes 2 bytes response code and data size of HART command.
 (Ex: HART_CMD0 = 2(response code) +12(Input Data Length) =14)
- (5) Out Size: Set the output data length of HART sent command data.
 (Ex: HART_CMD0 will be 0, HART_CMD6 will be 1)
- (6) In Offset: Set the input offset of HART returned command data.
 (HG_Tool v1.5.0 or newer supported, refer to example FAQ26)

5.3.4.4 Default Output Data

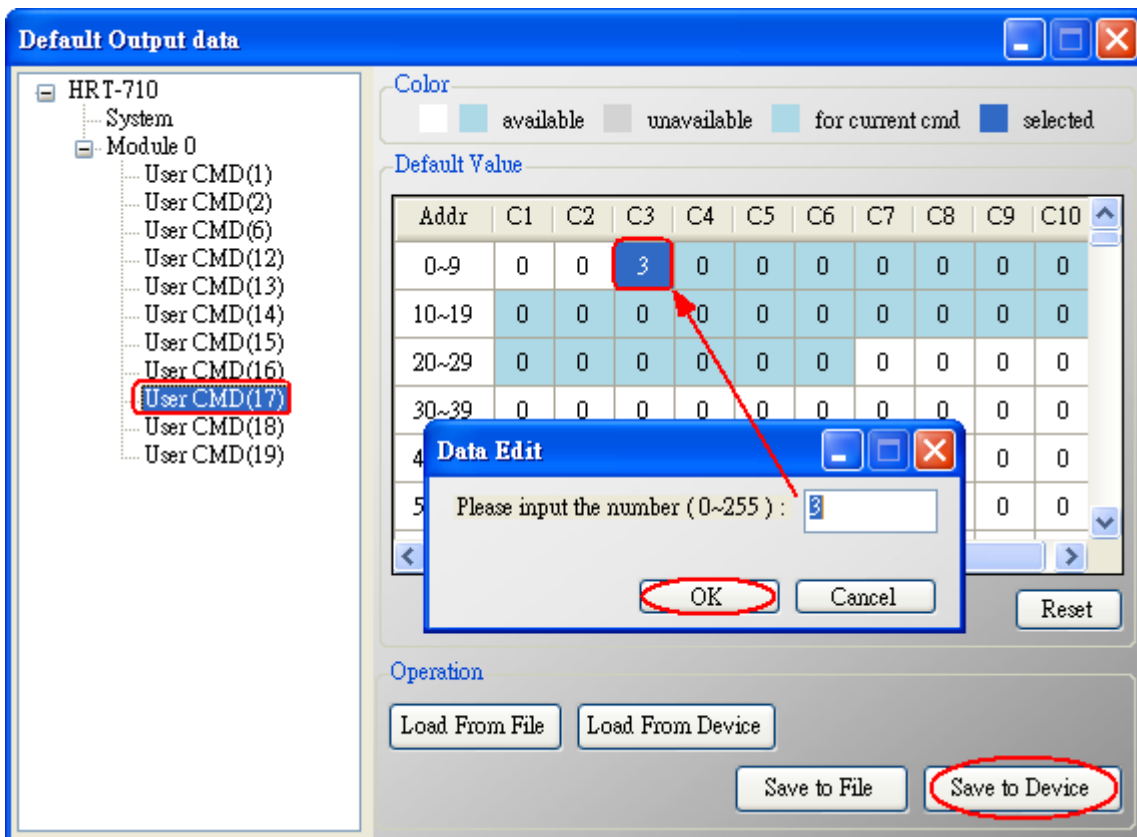

Figure 43: The window of default output data

It is used to set the default value for all UserCMD output data.

- (1) Click the left “User CMD” item and if the output length of the “User CMD” is not zero, then the occupied address will be blue in the right window.
- (2) Double click the address field and it will show the “Data Edit” window to set the default value.

5.3.4.5 Address Map

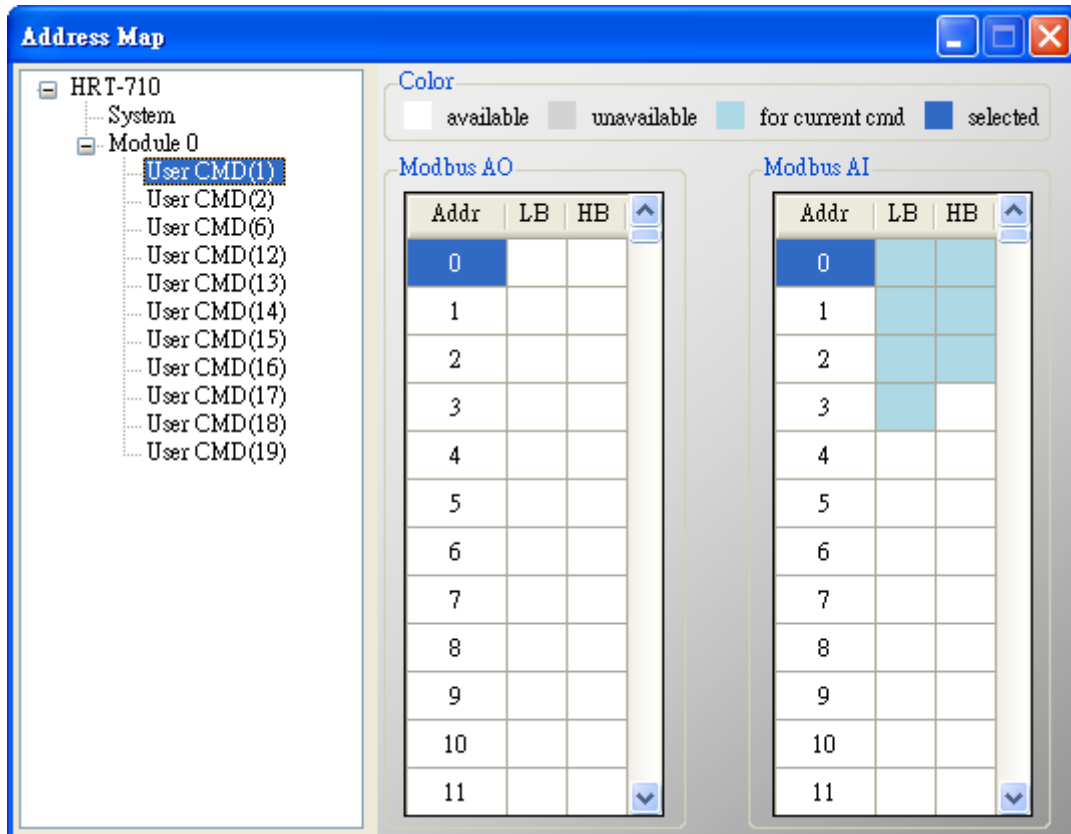

Figure 44: The window of address map

It is used to show the MB address for all User CMD.

- (1) Click the left “User CMD” item and the occupied address of the “User CMD” will be blue in the right Modbus AO or Modbus AI table.
- (2) The data of Modbus AI table can be read by MB Function Code 4.
- (3) The data of Modbus AO table can be read by MB Function Code 3 and written by MB Function Code 6 or 16.

[Note]

The MB address of the default command is fixed, so users can refer to section 4.3 – “Modbus / HART Mapping Table” to get the address.

5.3.4.6 Device Diagnostic

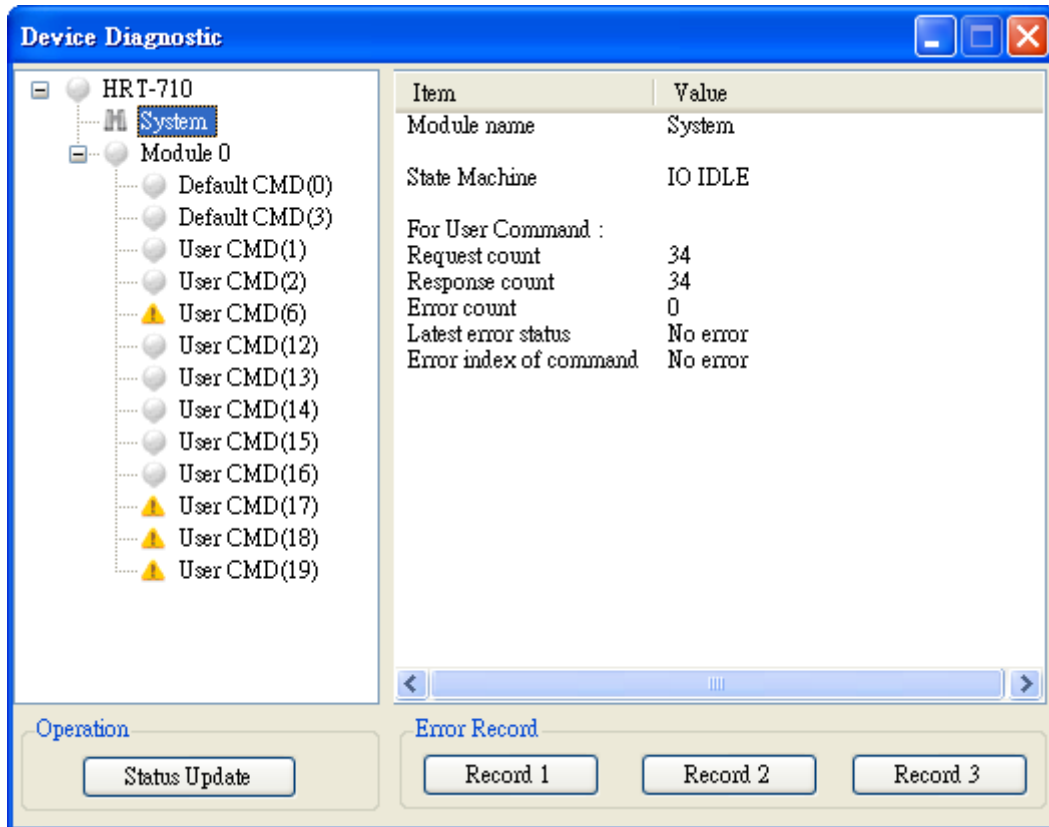





Figure 45: The window of device diagnostic

It is used to show the status of HART command in HRT-7(3)10.

(1) Click the left “User CMD” item and the icon of the item will show the status described as below:

1.  → It means no error.
2.  → It means the command has never been executed.
3.  → It means the command has error and the error status shows at the right side of the window.
4.  → It means the item is selected.

(2) “Status Update” button: Refresh the status of HART Cmd.

(3) “Record” button: HRT-7(3)10 will record the latest error command and save to “Record 1~3”. Users can get these records by click “Record 1”, “Record 2” and “Record 3” button.

5.3.4.7 Through Mode

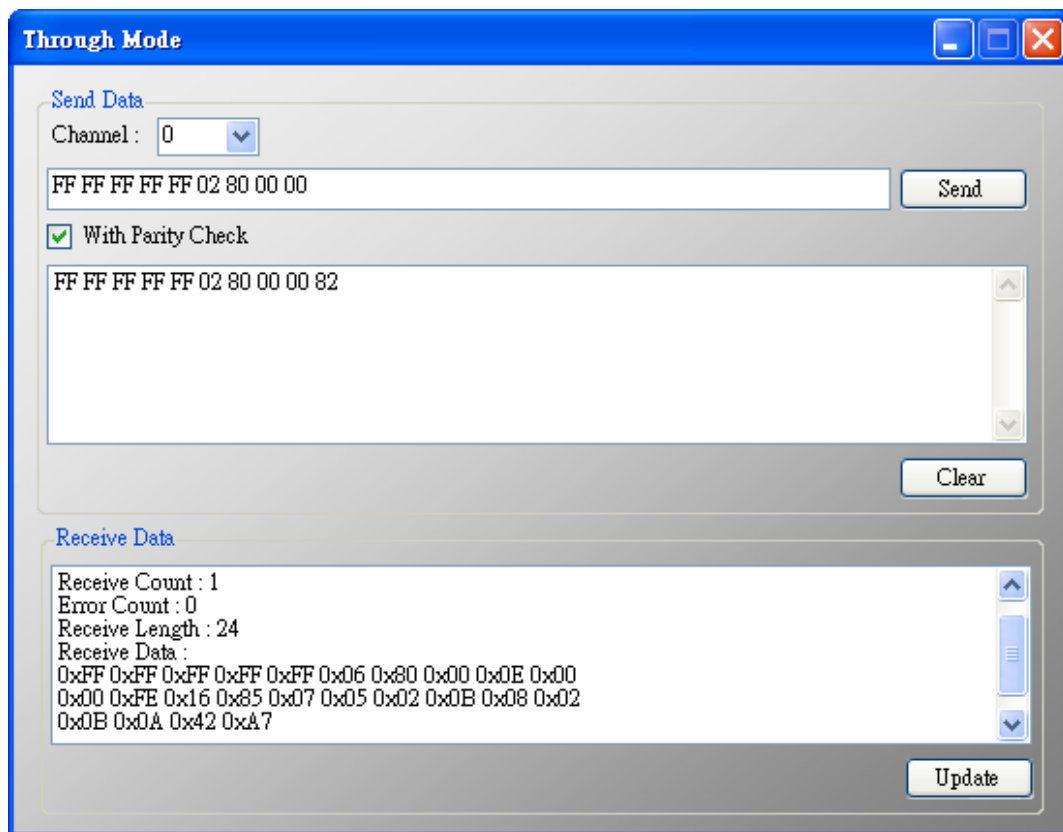

Figure 46: The window of through mode

It is used to send / receive HART command directly.

EX: Send a short frame HART command 0 and receive the response.

- (1) In "Send" field, fill in the data - "0xFF 0xFF 0xFF 0xFF 0xFF 0x02 0x80 0x00 0x00" and then click "Send" button to send HART Cmd.
- (2) Click "Update" button to show the response of HART device.

Warning: Before using through mode function, please check the below items:

- (1) The "RUN" LED is always on.
- (2) The "auto polling" function is disabled. (Refer to section 5.3.4.2 – "The Basic Operation of System item")

5.3.4.8 Format Translation



Figure 47: The window of format translate

Here we provide some tools for HART communication. “Packed ASCII Translate” tool can convert “Packed ASCII” into ASCII format. “IEEE754 Translate” tool can convert “IEEE754” into byte format.

- (1) “Packed ASCII Translate”: It can be used to convert between “Packed ASCII” and “ASCII” format.

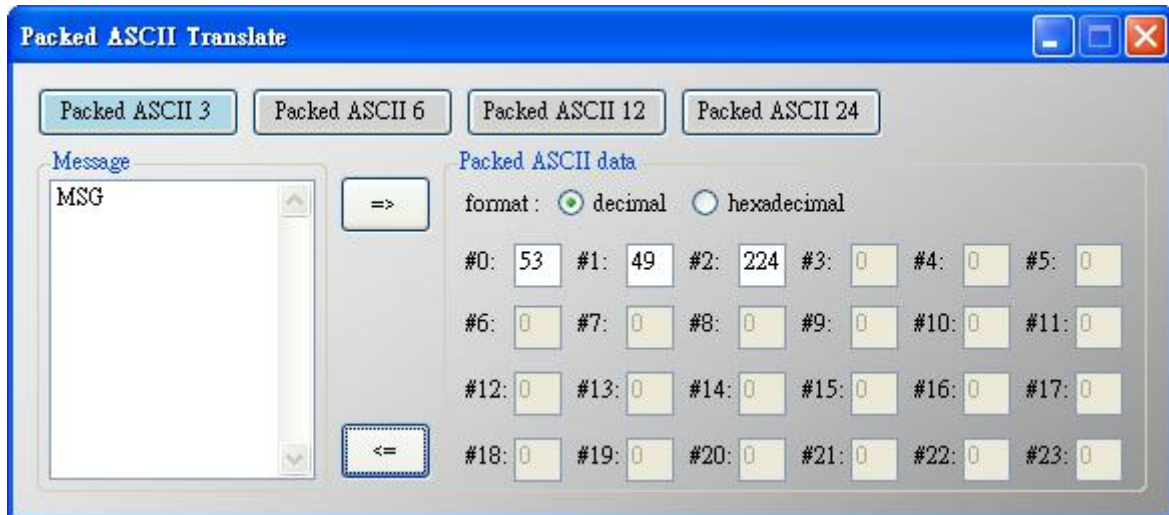

Figure 48: The window of packed ASCII translate

- (2) “IEEE 754 Translate”: It can be used to convert between “IEEE754” and “DWORD” format.

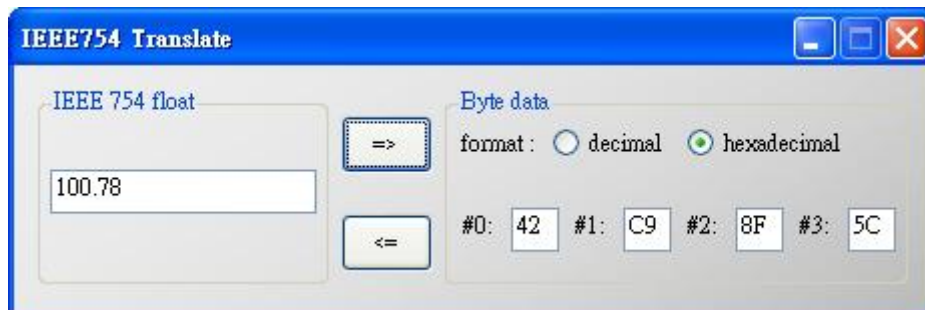

Figure 49: The window of IEEE754 translate

5.3.4.9 About



Figure 50: The window of About

5.4 Establish connection with module

The connection between HG_Tool and HRT-7(3)10 is shown as Figure 51.

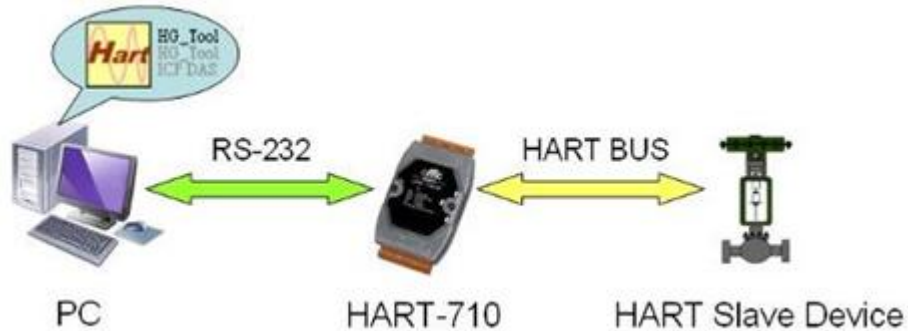

Figure 51: The connection of Utility and HRT-710

Please follow the below steps to establish connection with HRT-7(3)10.

Step 1: Wire COM Port of PC to RS-232 port of HRT-7(3)10

Step 2: Run “HG_Tool” on PC.



Figure 52: Run “HG_Tool” Utility

Step 3: Set COM Port comm. setting of HG_Tool the same as HRT-7(3)10

The default settings of HRT-7(3)10 are as below.

[1] protocol: MB RTU

[2] Net ID: 1

[3] baud rate: 115200 bps

[4] data bits: 8 ; stop bits: 1 ; parity: None.

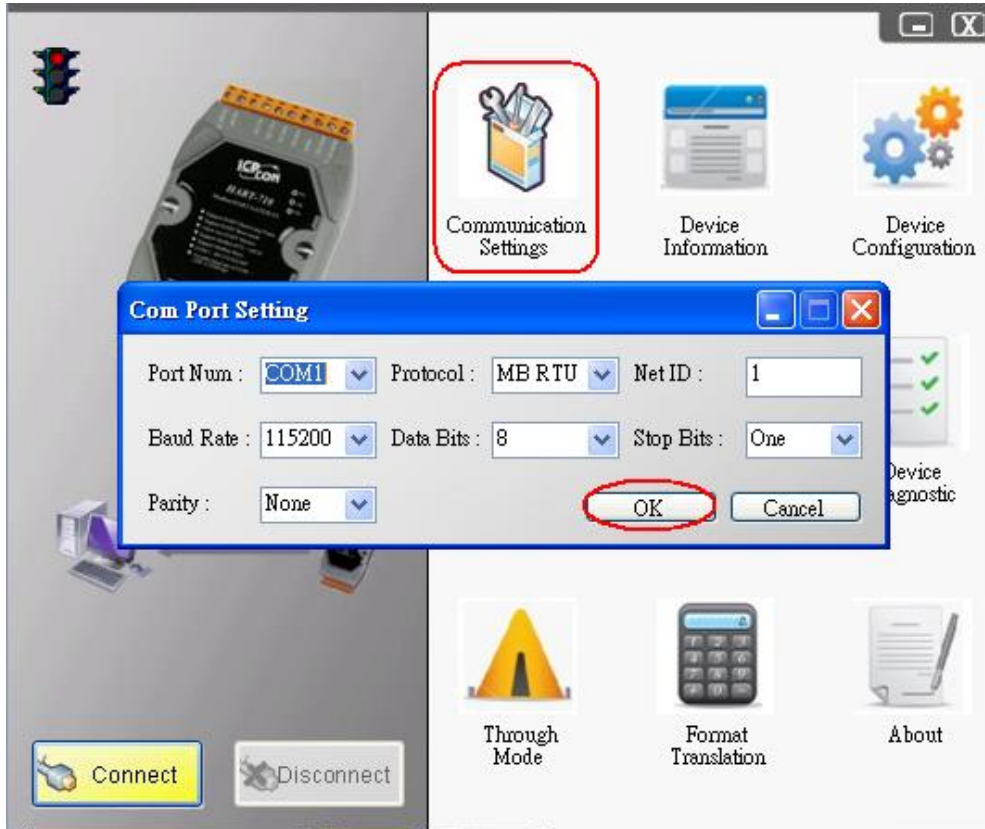

Figure 53: Com Port settings of the utility

Step 4: Click “Connect” button.

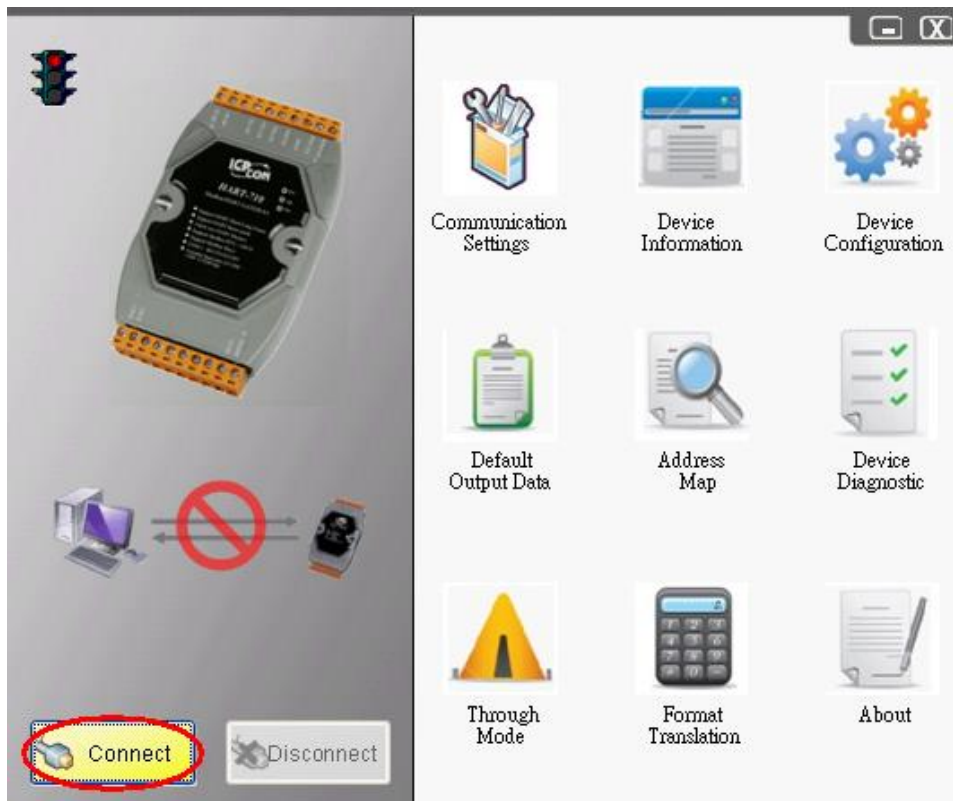

Figure 54: Click “Connect” button

Step 5: If the connection is successful, then the traffic light shows green.



Figure 55: Connection status

6. Troubleshooting

The troubleshooting list can help users to resolve the problems when using the HRT-7(3)10. If the problem still can't be solved, please E-mail to ICP DAS : service@icpdas.com.

[Table 7: Errors and Solutions]

No	Trouble state	Solution
1	The 'PWR' LED of is always off	Please check the power wiring of HRT-7(3)10 and the voltage is between 10~30Vdc.
2	The 'RUN' LED always flashes.	Flash once per second: [Reason] Module is always in initial mode. It means HRT-7(3)10 can't connect to all the configured HART devices. [Resolve] 1. Please check the wiring between HRT-7(3)10 and HART devices and the configuration of HRT-7(3)10. 2. If the problem still exists, please connect to only one HART device. Then set the configuration of HRT-7(3)10 again and reboot module to test it again. Flash once per half second: [Reason] HRT-7(3)10 has received the burst frame from HART device. [Resolve] In burst mode, the HRT-710 must work at the "Point to Point" network and disable the "auto polling" function.
3	The 'ERR' LED always flashes.	[Reason] It means some errors happened in the user CMD. [Resolve] Users can get the error status by using the "Device Diagnostic" function of HG_Tool.

7. Dimensions

[HRT-710]

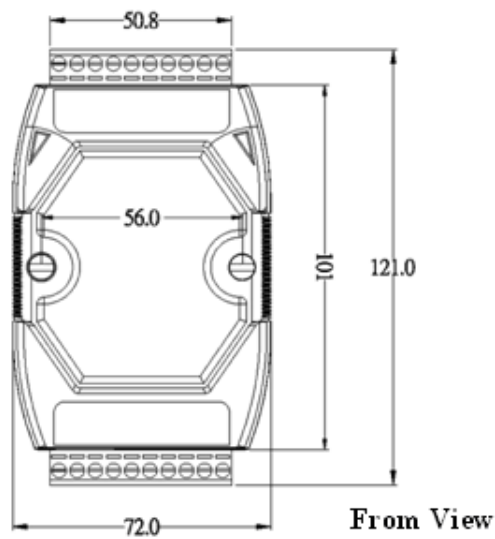
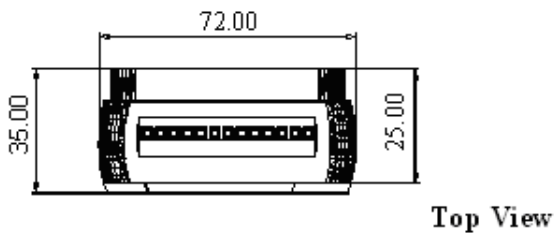
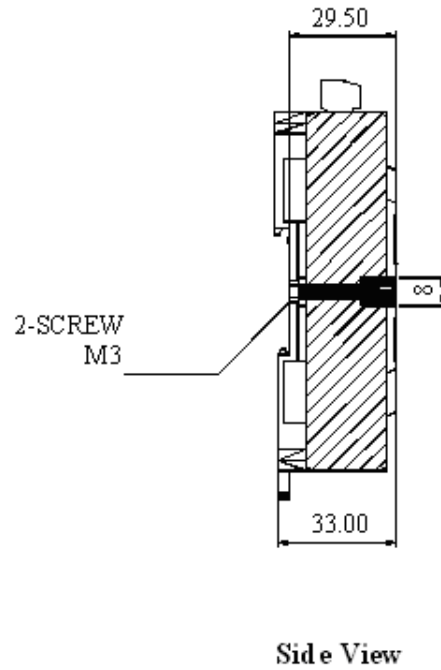
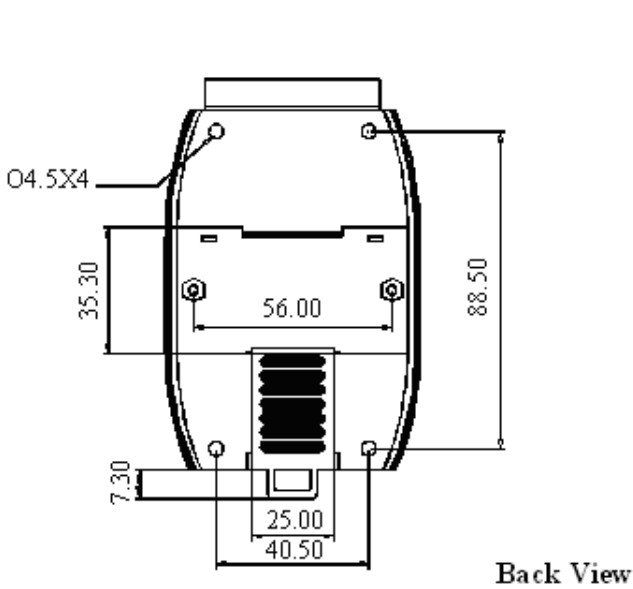

Unit : mm

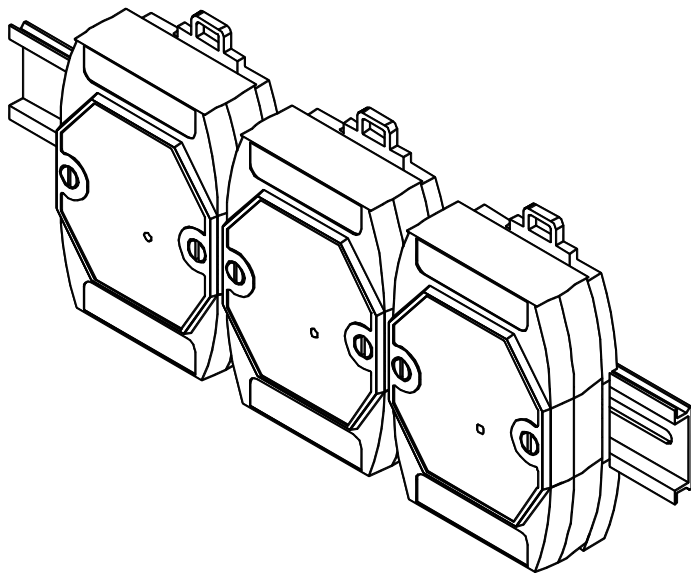
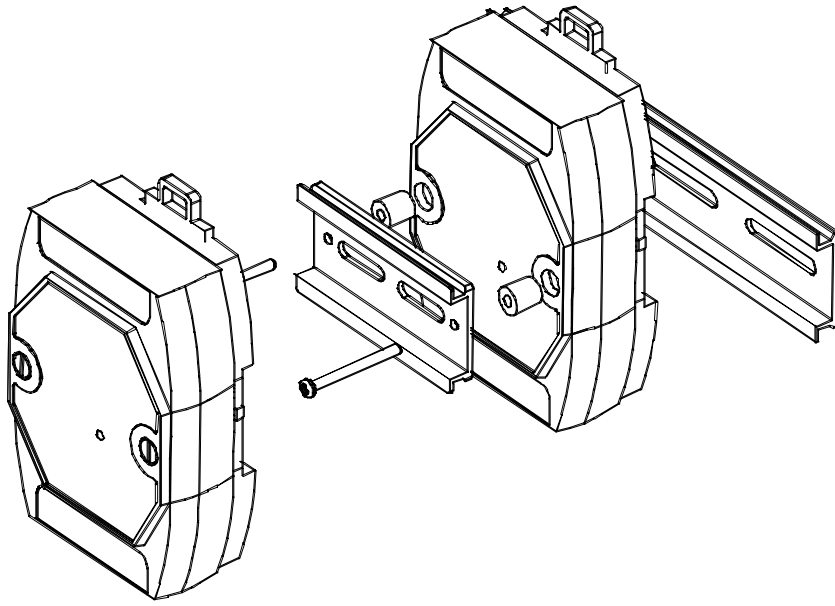

[HRT-310]

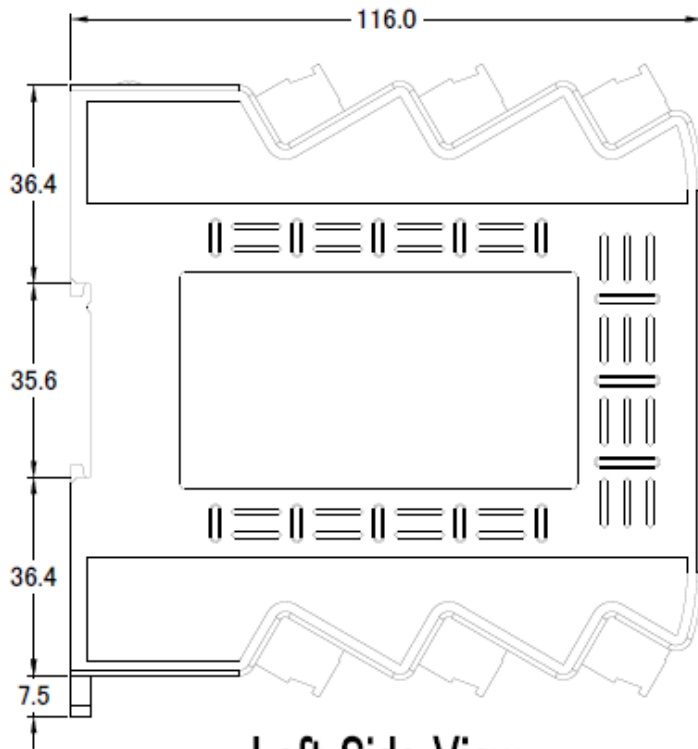

Left Side View

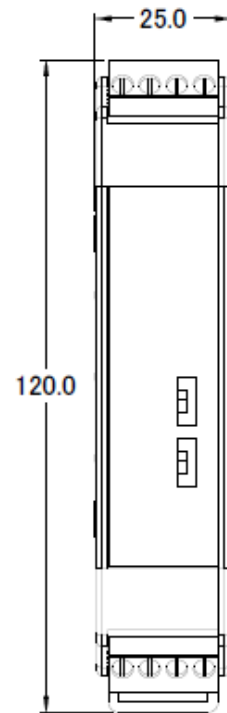

Front View

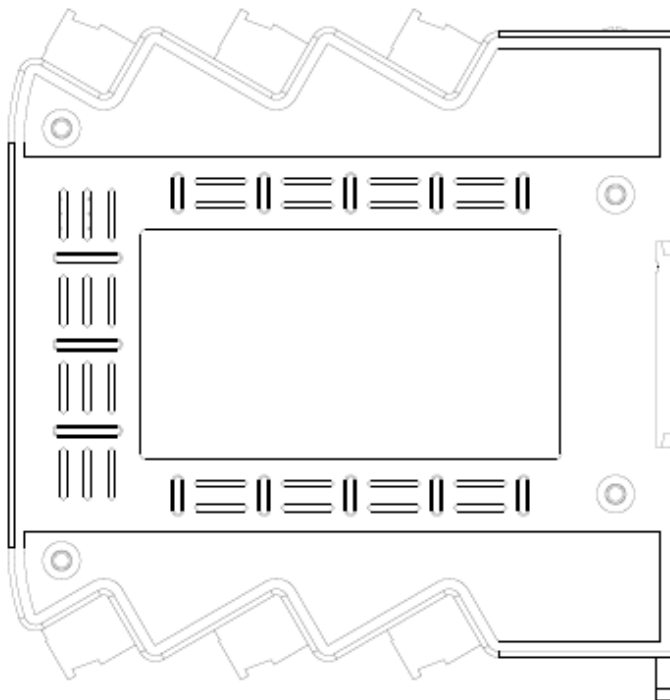

Right Side View

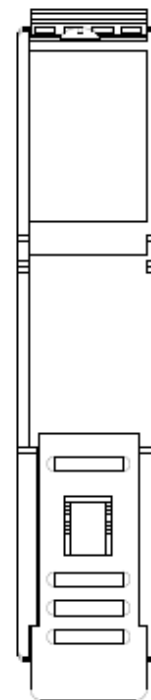

Rear View



8. FAQ

Q01 : How to add HART devices to HRT-710 ?

A01:

1. Add “Only One” HART device : (Ex : Add ABB AS800 HART device)

[Step 1] Connect to HRT-710 with “HG_Tool” utility.

(1) Set the com port parameters.

(2) Click the “Connect” button to connect to HRT-710 module like Figure 1-1.

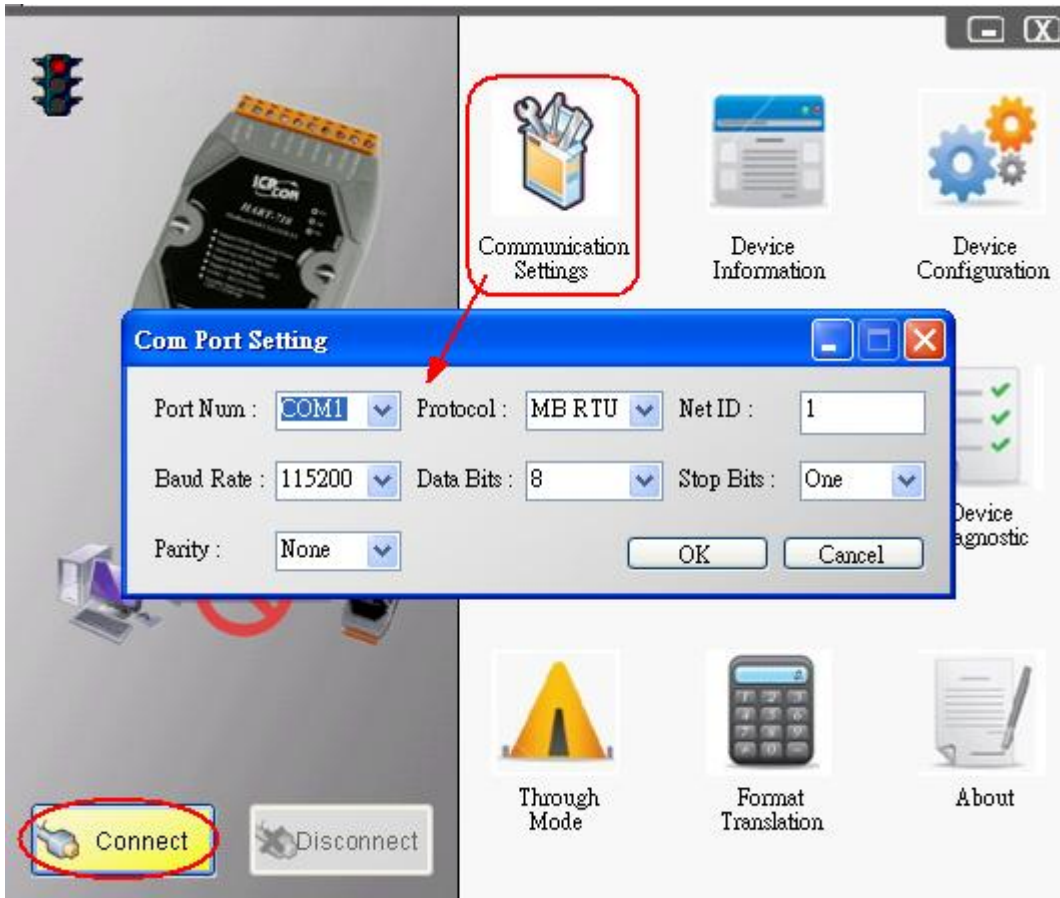

Figure 1-1 Connect to HRT-710

[Step 2] Delete the default HART device setting in HRT-710

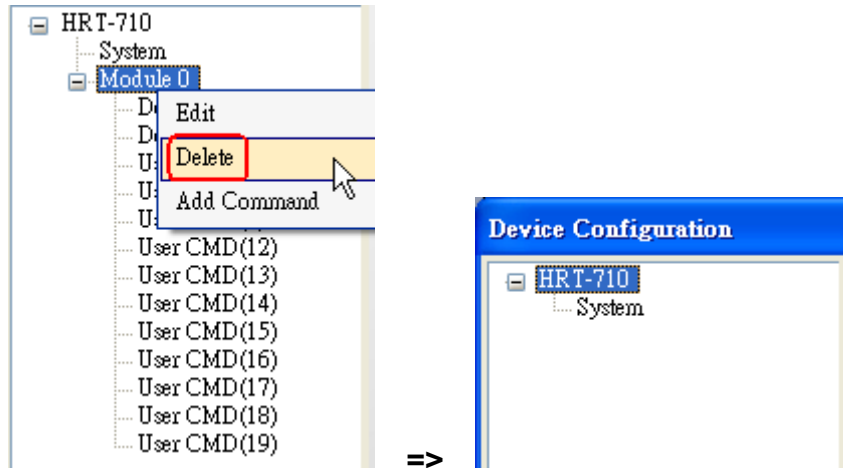

Figure 1-2 Delete the default setting of HRT-710.

[Step 3] Add the new HART device setting

(1) Method 1 => Choose “Auto Configure” option to be Enable like Figure 1-3.

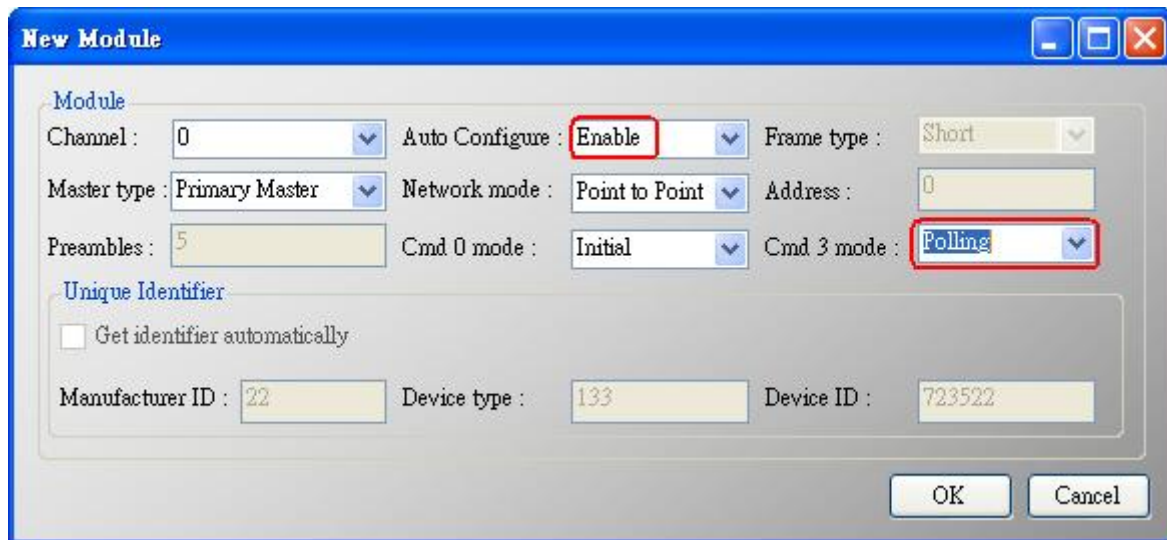
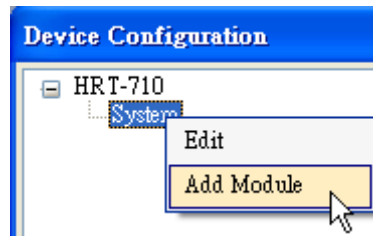

Figure 1-3 Add new HART device setting (Auto Config : Enable)

(2) Method 2 => Choose “Auto Configure” option to be Disable like Figure 1-4.

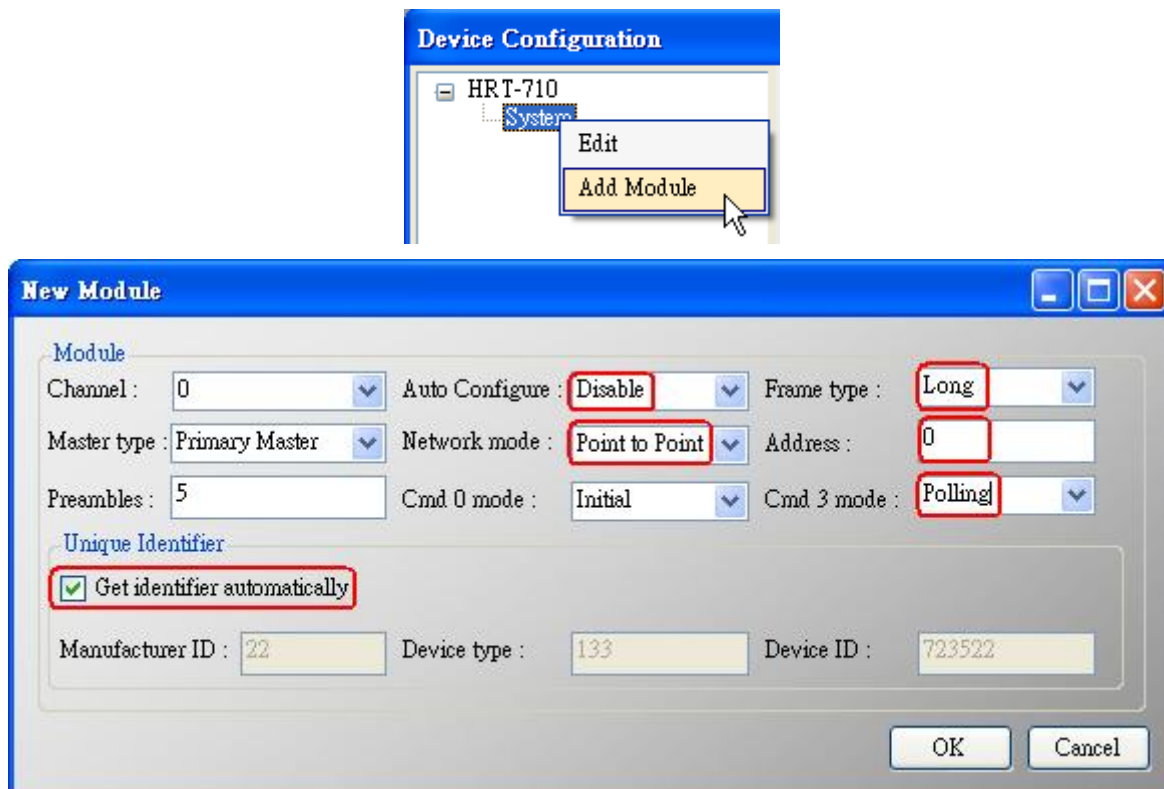

Figure 1-4 Add new HART device setting (Auto Config : Disable)

[Step 4] Save the HART device setting to HRT-710

- (1) Click the “Save to Device” button to save the new HART device setting to HRT-710 like Figure 1-5.

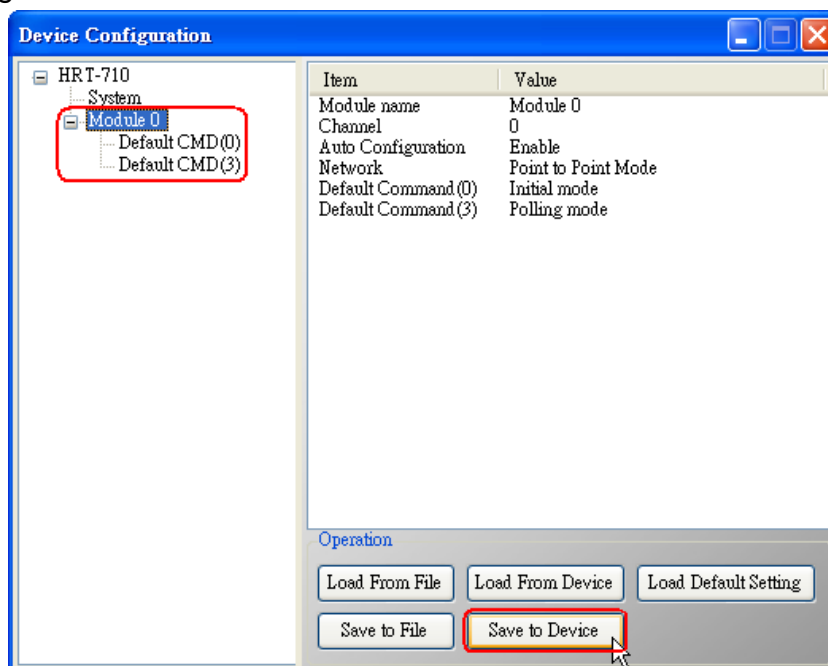

Figure 1-5 “Save to Device” function

2. Add “More than One” HART devices : (Ex : Add two HART devices)

- (1) Foxboro I/A Pressure (Addr=1)
- (2) ABB AS800 (Addr=2)

[Note]

Users need to set the address of every HART device between 1 to 15 first. The address 0 is not allowed in HART multi-drop network.

[Step 1] Connect to HRT-710 with “HG_Tool” utility.

[Step 2] Delete the default HART device setting in HRT-710

=> These above two steps are the same with those of the “Only One” HART device.

[Step 3] Add two new HART device setting

- (1) Click “Auto Configure” option to be Disable like Figure 1-6.

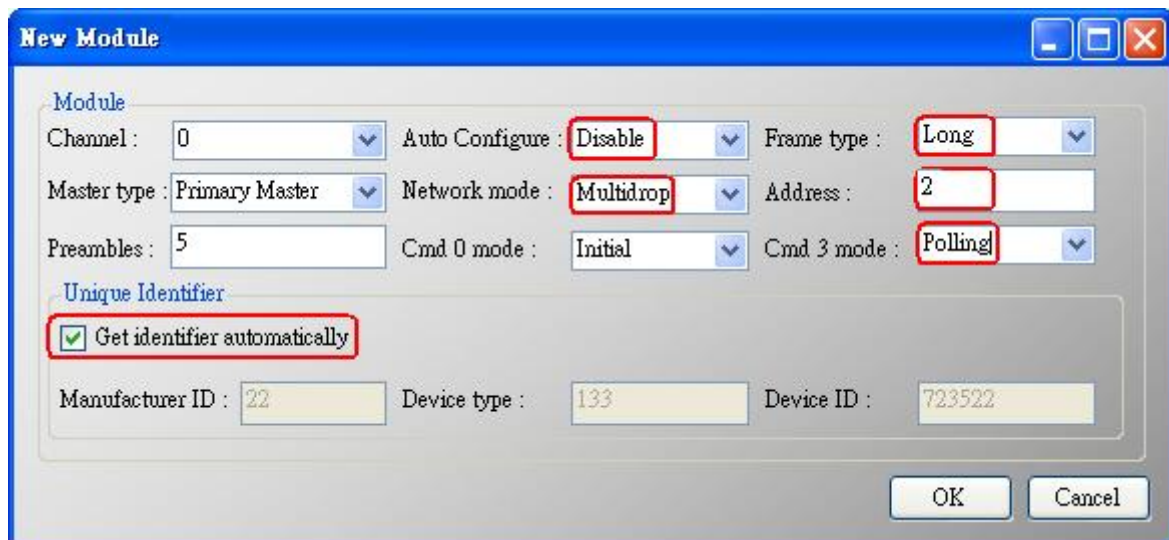
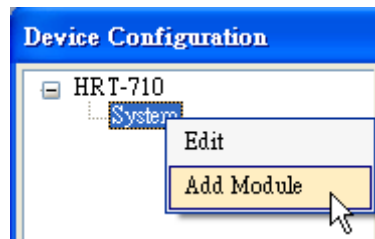

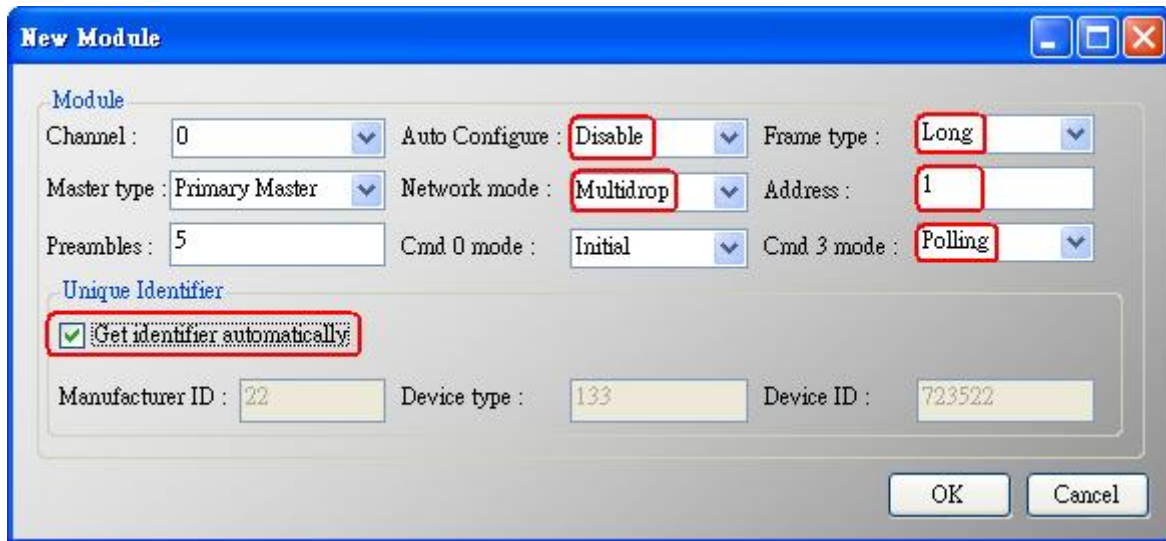

Figure 1-6 Add new HART device setting

[Step 4] Save the HART device setting to HRT-710

- (1) Click the “Save to Device” button to save the new HART device setting to HRT-710 like Figure 1-7.

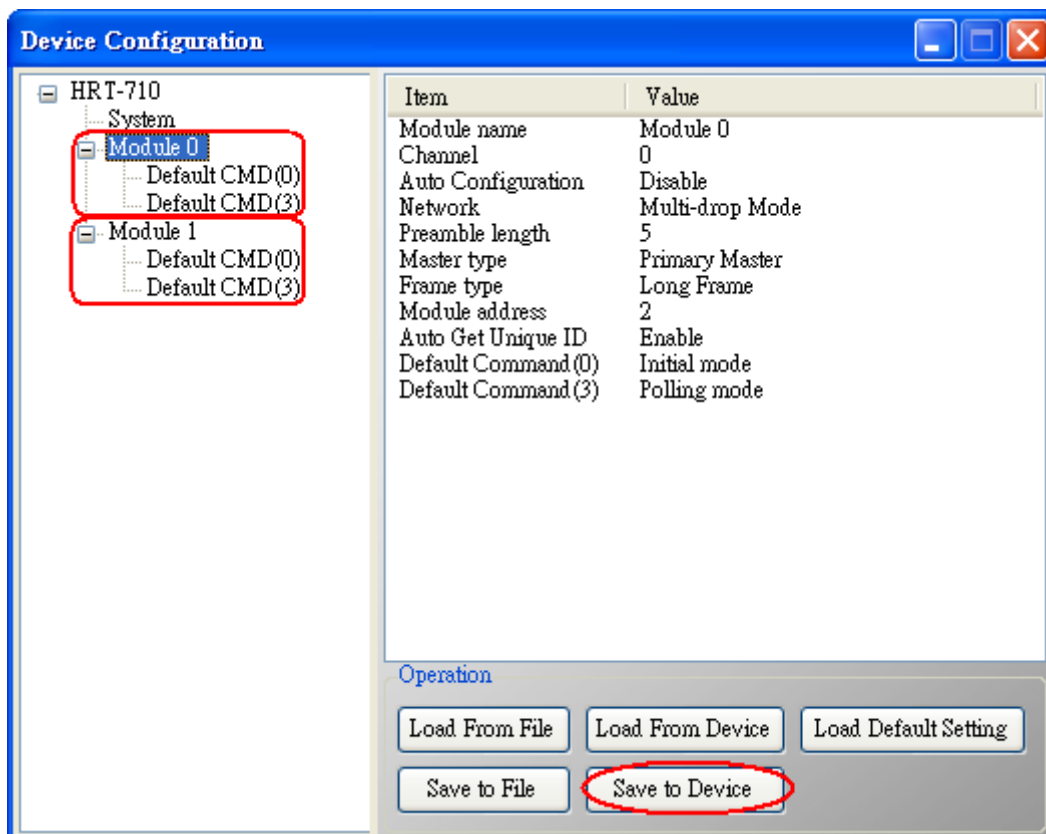

Figure 1-7 “Save to Device” function

Q02 : How to make sure that HRT-710 gets the HART device data correctly ?

A02:

After adding HART device setting to HRT-710 module (refer to the steps of Q01), please follow the steps.

- (1) Make sure connecting to HRT-710 with HG_Tool successfully and then click “Device Information” button like Figure 2-1.



Figure 2-1 “Device Information” screen

[Check I/O Data of the Default CMD(0)]

- (2) Right click the button of mouse on the “Default CMD(0)” item and choose the “Basic operation” option to open the “I/O Data” screen of the “Default CMD(0)” like Figure 2-2.

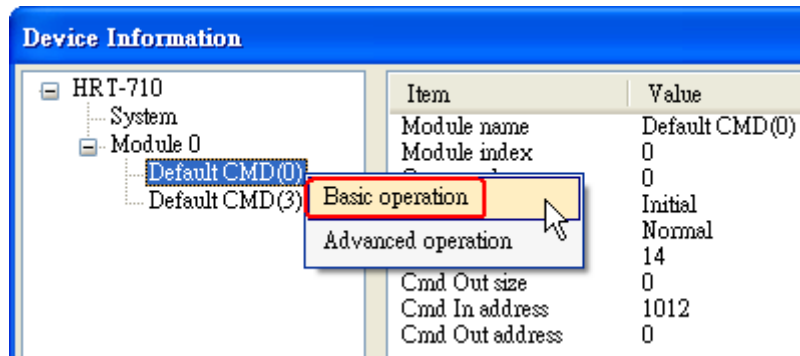

Figure 2-2 The “Basic operation” of the “Default CMD(0)”

(3) The I/O Data of the “Default CMD(0)” is OK like Figure 2-3.

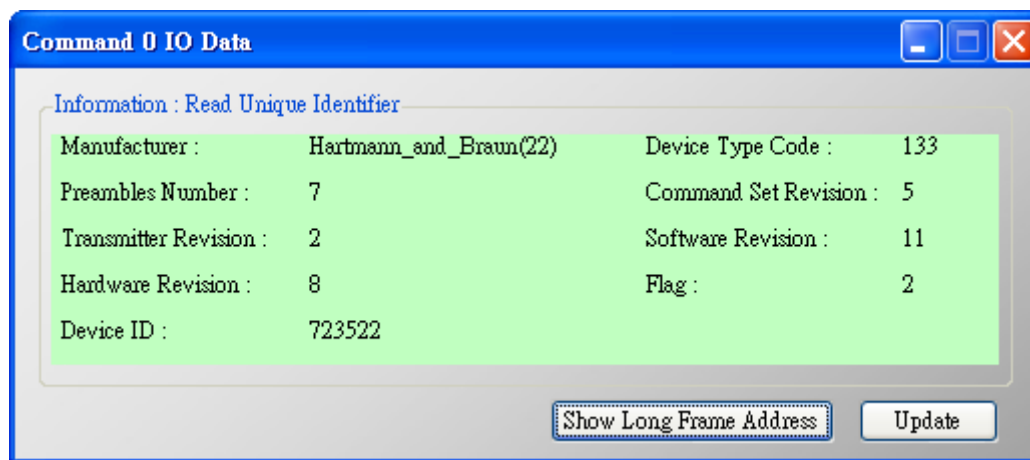

Figure 2-3 The I/O Data screen of the “Default CMD(0)” => OK

(4) The I/O Data of the “Default CMD(0)” is NG like Figure 2-4.

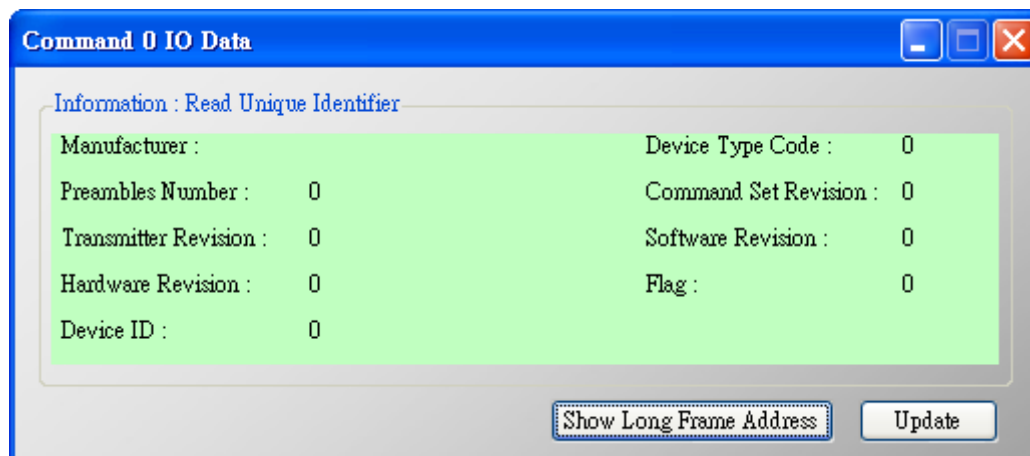

Figure 2-4 The I/O Data screen of the “Default CMD(0)” => NG

[Check I/O Data of the Default CMD(3)]

(5) Right click the button of mouse on the “Default CMD(3)” item and choose the “Basic operation” option to open the “I/O Data” screen of the “Default CMD(3)” like Figure 2-5.

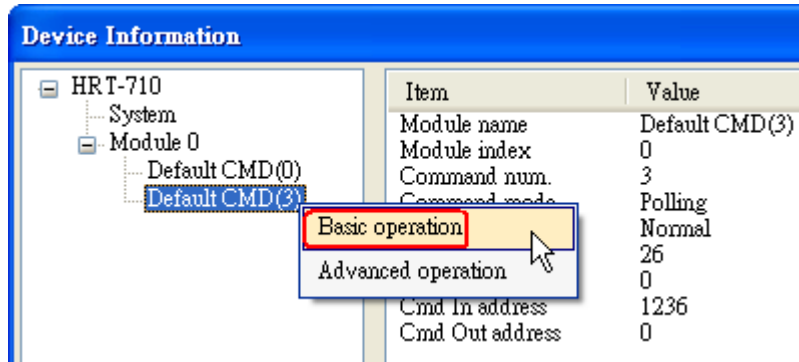

Figure 2-5 The “Basic operation” of the “Default CMD(3)”

(6) The I/O Data of the “Default CMD(3)” is OK like Figure 2-6.

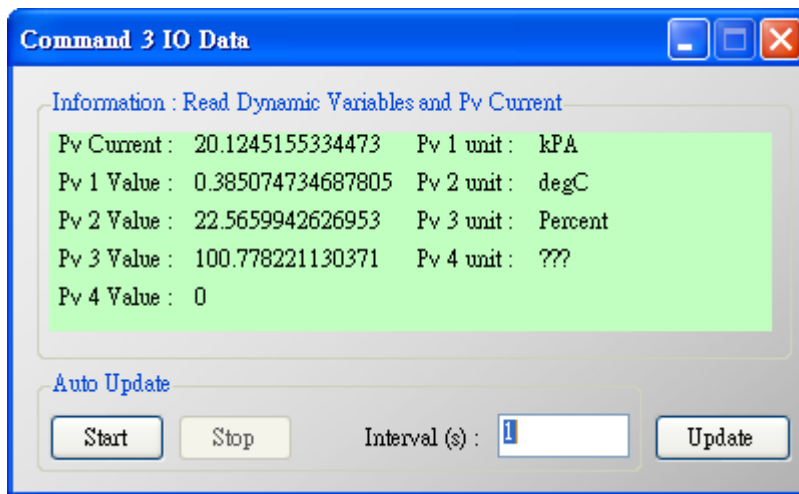

Figure 2-6 The I/O Data screen of the “Default CMD(3)” => OK

(7) The I/O Data of the “Default CMD(3)” is NG like Figure 2-7.

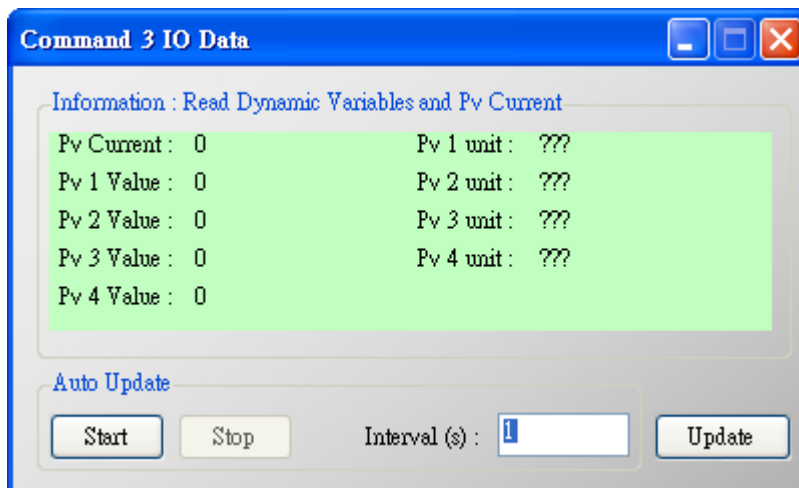

Figure 2-7 The I/O Data screen of the “Default CMD(3)” => NG

=> If the I/O data of the “Default CMD(0)” and “Default CMD(3)” is ok, it means that the communication between HRT-710 and HART devices is ok.

Q03 : How to map HART device CMD(3) data directly to SCADA or HMI ?

A03:

- (1) Make sure that the communication between HRT-710 and HART device is ok. (Refer to the steps of Q02)
- (2) Set “Swap Mode” of system setting in HRT-710 to be “W&B”.
 - [1] In “Device Configuration” screen, right click the button of mouse on “System” item and click the “Edit” option to open “System Edit” screen like Figure 3-1.

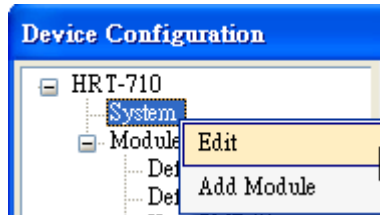

Figure 3-1 Open “System Edit” screen

- [2] Set the “Swap mode” item to be “W&B” and click “OK” button like Figure 3-2.

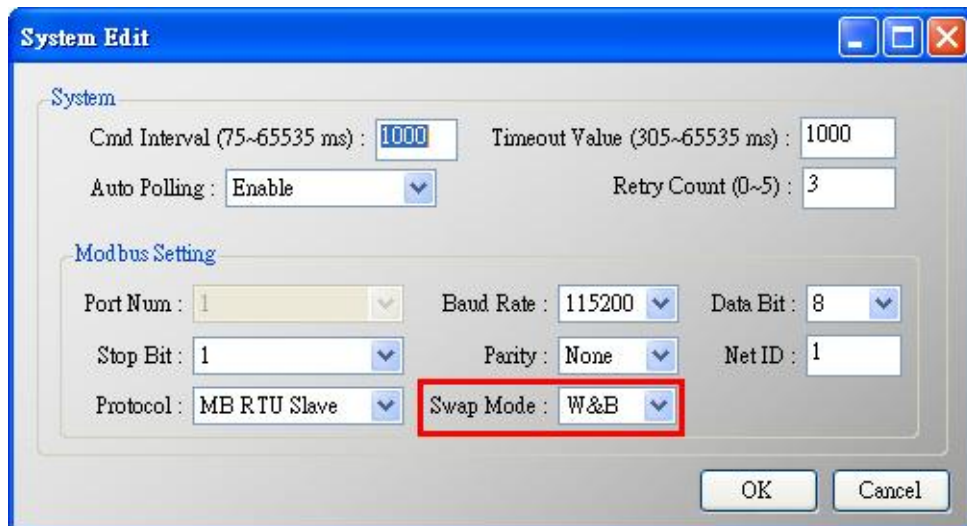

Figure 3-2 Set “Swap mode” to be “W&B”

- [3] Click the “Save to Device” button to save the new system setting to HRT-710 like Figure 3-3.

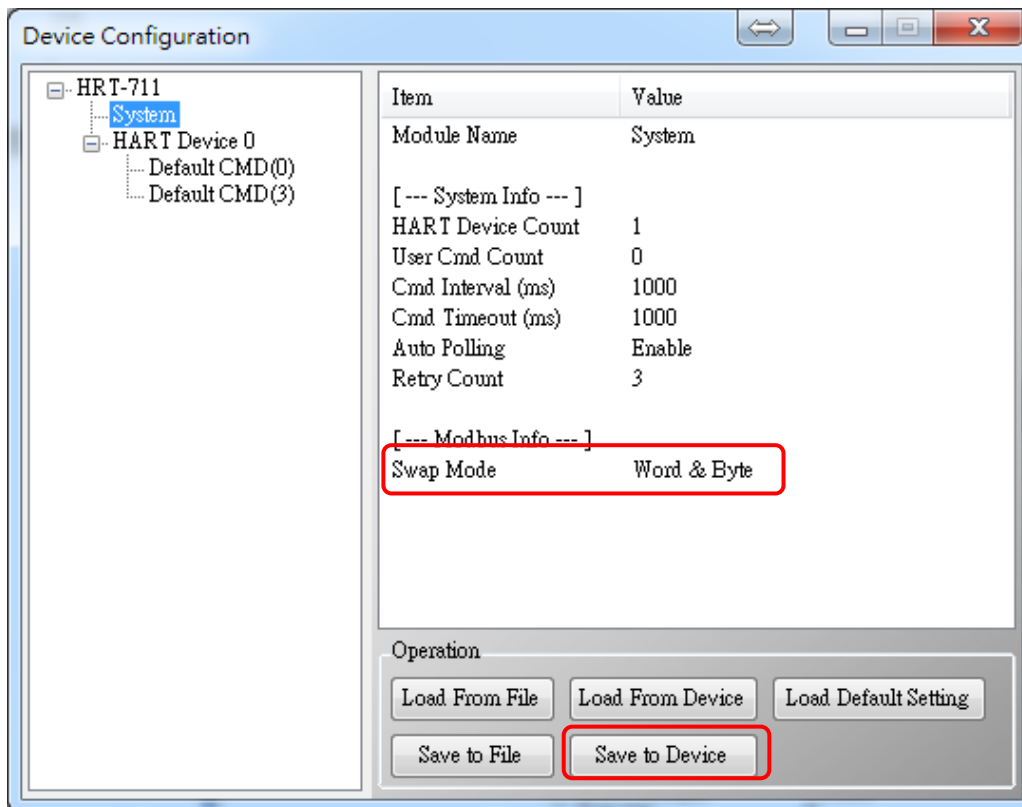

Figure 3-3 “Save to Device” function

(3) Check the firmware version of HRT-710 like Figure 3-4.

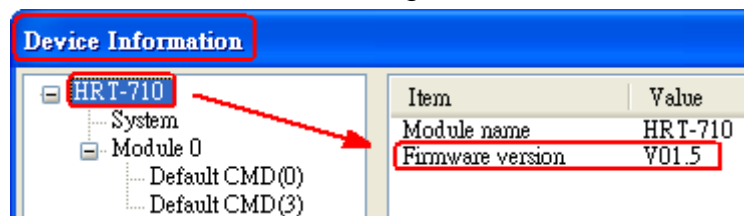

Figure 3-4 Firmware Version of HRT-710

(4) Follow the below steps according to the different firmware version of HRT-710.

[4.1 - The firmware version of HRT-710 is v1.5 or newer]

[1] In firmware v1.5 or newer, HRT-710 provides the MB Address 1300 ~ 1459 (Default CMD(3)(S) Data for Module 0 ~ 15 in HRT-710 => The detailed information refers to the sector 4.3 of users’ manual) and users can map the CMD(3) data of HART device to SCADA directly with these Modbus address 1300 ~ 1459.

[2] For the “Default CMD(3)(S) data of Module 0” in HRT-710, the mapped MB address is 1300 ~ 1309. The below MB/RTU client will use the “ModScan” and “Modbus Poll” tool to show the CMD(3) data of HART device by polling Modbus address 1300 ~ 1309.

<1> Confirm the connection between HG_Tool and HRT-710 is disconnected.

<2> Make sure the HRT-7(3)10 is in the Normal operation. (Set the “Dip Switch” on the

back of HRT-7(3)10 to be “Normal” and reboot HRT-7(3)10.)

<3> Set the “Display” mode to be “Float” format as Figure 3-5

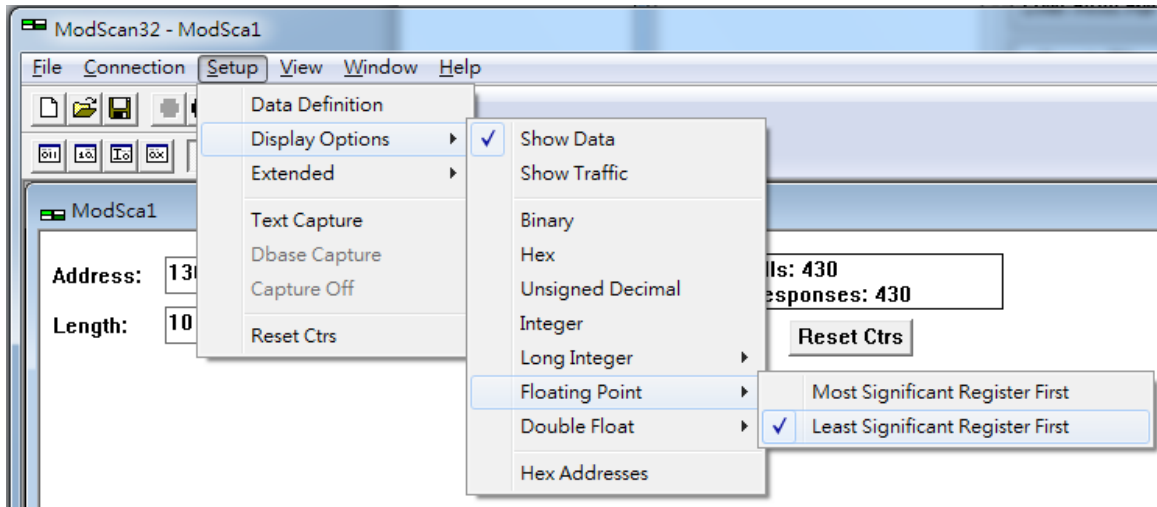

Figure 3-5 Modbus display format

<4> Fill the connection parameters and click “OK” button to connect to HRT-7(3)10, e.g.

Figure 3-6

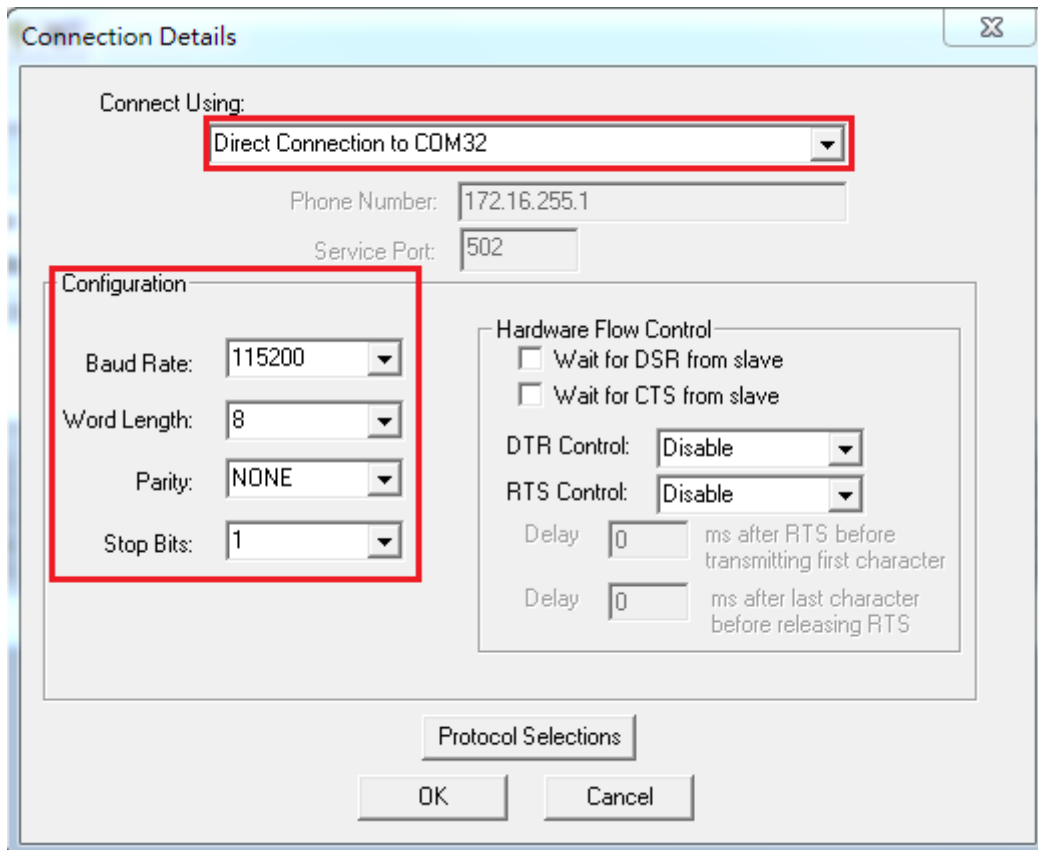

Figure 3-6 Connection parameters

<5> The CMD(3) data of HART device is successfully read, e.g. Figure 3-7

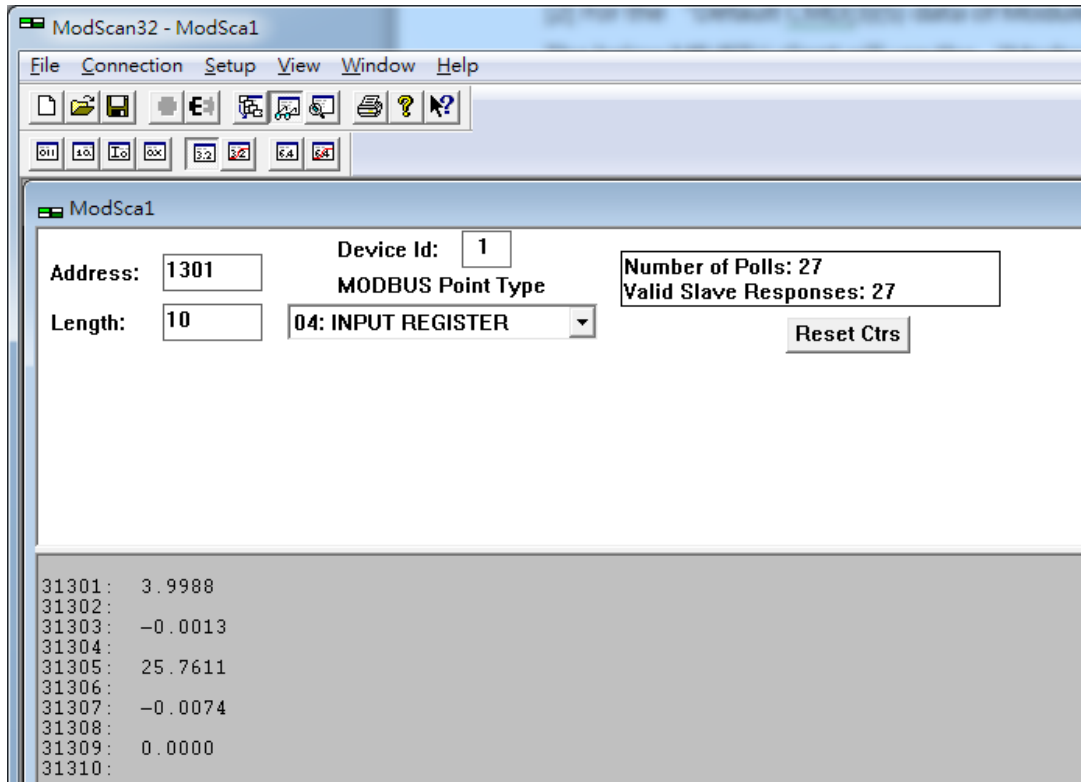

Figure 3-7 The CMD(3) data of HART device

[Note] ModScan designed to use PLC address (Base 1), so the polling address entered needs to be 1301. Users can make sure the actual polling address is [05][14] (1300) by selecting “Show Traffic” of the “Display Option” within “Setup” menu after successful connected, shown as Figure 3-8

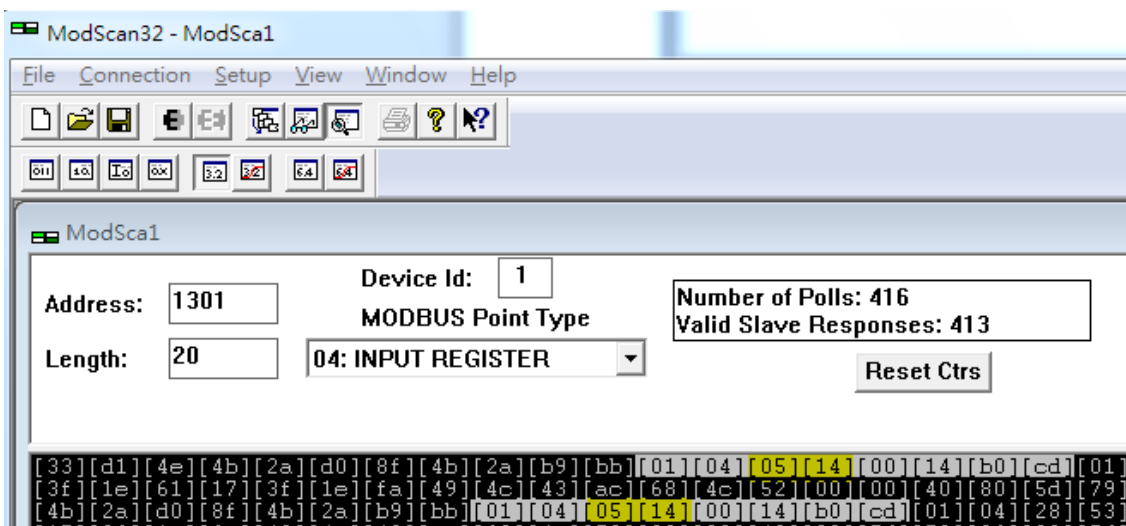

Figure 3-8 The actual polling Modbus address

<6> Check and modify Modbus Poll Address Base types and display formats like Figure 3-9.

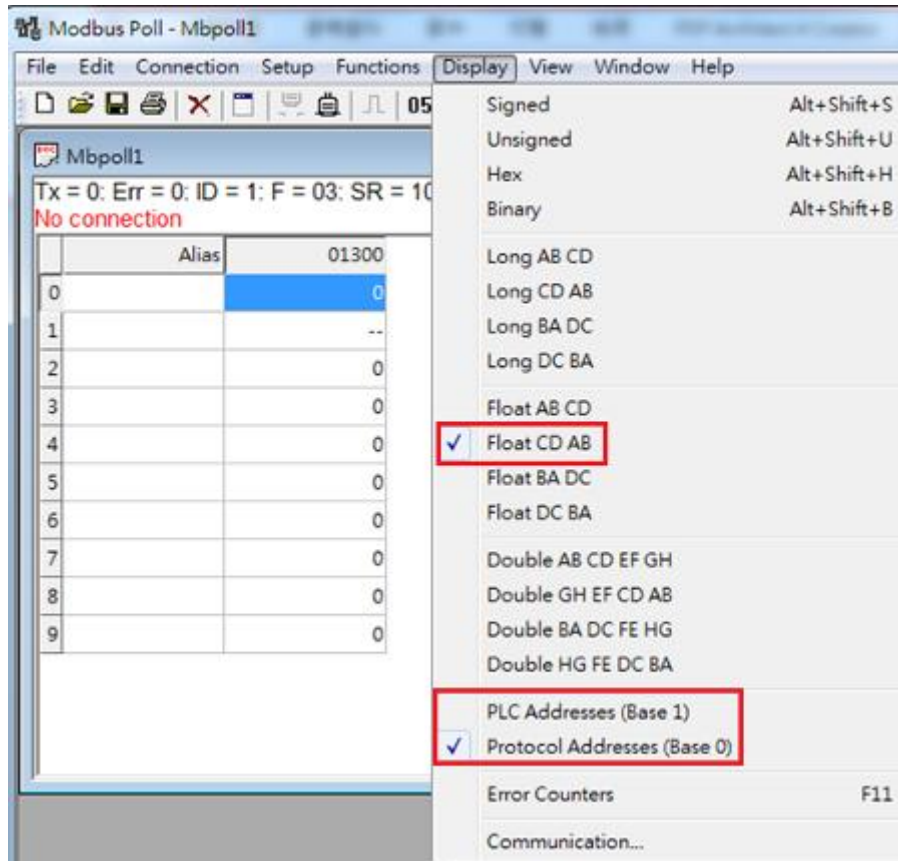

Figure 3-9 Address Base types and display formats

<7> Set the “Read/Write Definition” of Modbus Poll like Figure 3-10.

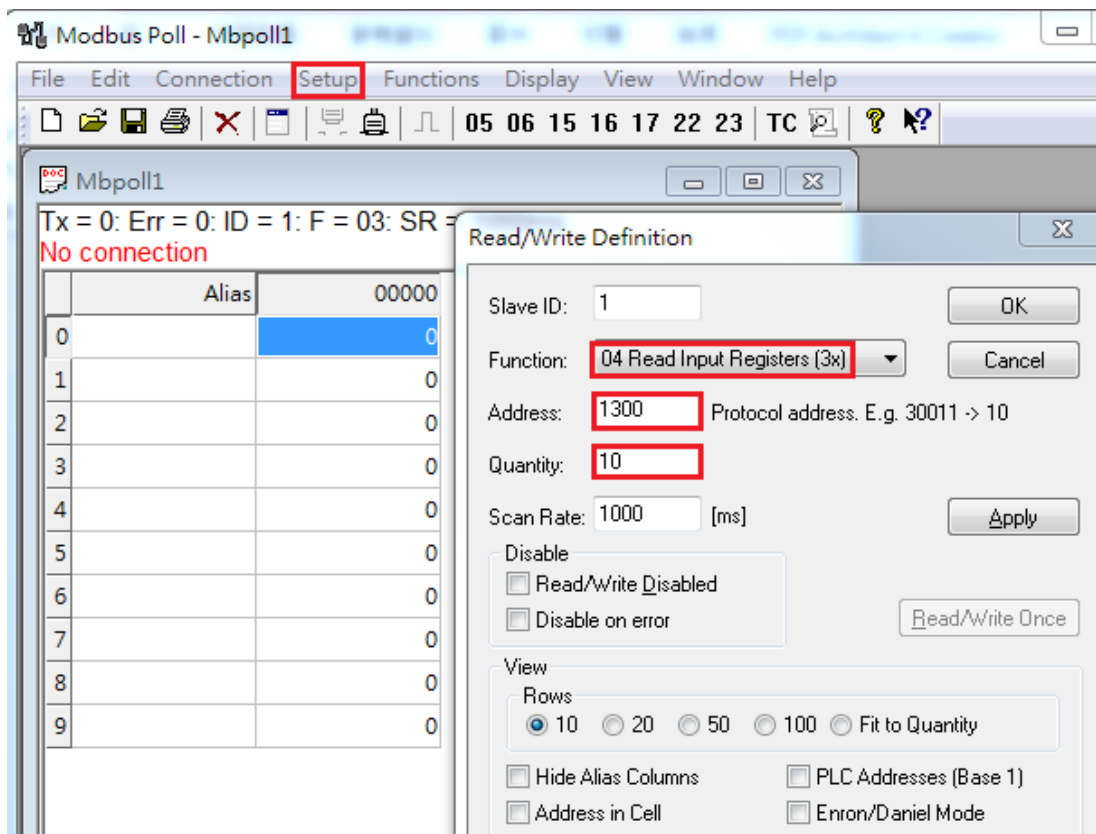

Figure 3-10 “Read/Write Definition” of Modbus Poll tool

[Note] The polling address is 1300 in this case because “Protocol Address (Base 0)” has been selected for Modbus Poll. If “PLC Address Poll (Base 1)” has been selected instead, then the address needs to be set as 1301. Users can make sure the actual polling address is [05][14] (1300) by checking the “Communication” dialog from “Display” menu after successful connected, shown as Figure 3-11

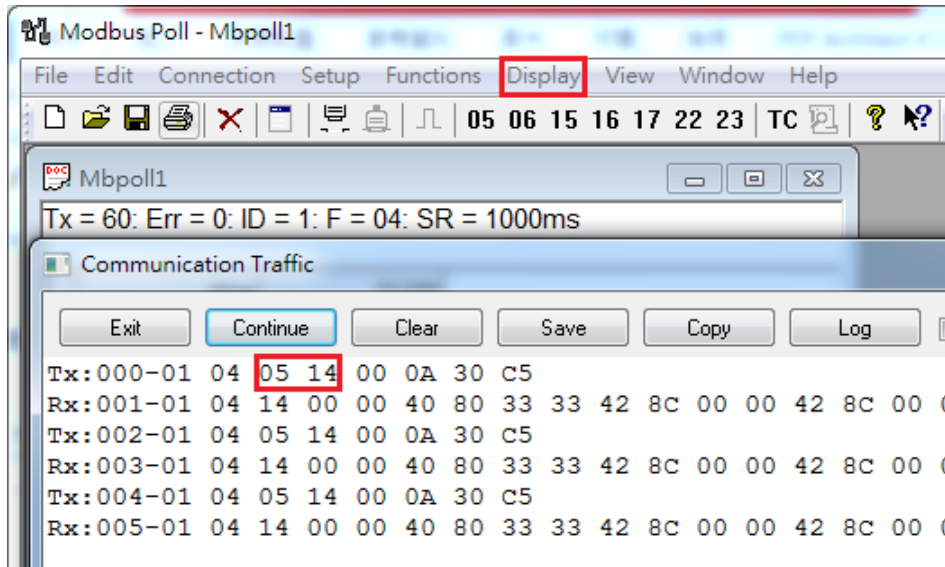

Figure 3-11 Polling address from “Communication Traffic”

<8> Set the “Com Port” parameters and click “OK” button to connect to HRT-710 like Figure 3-12.

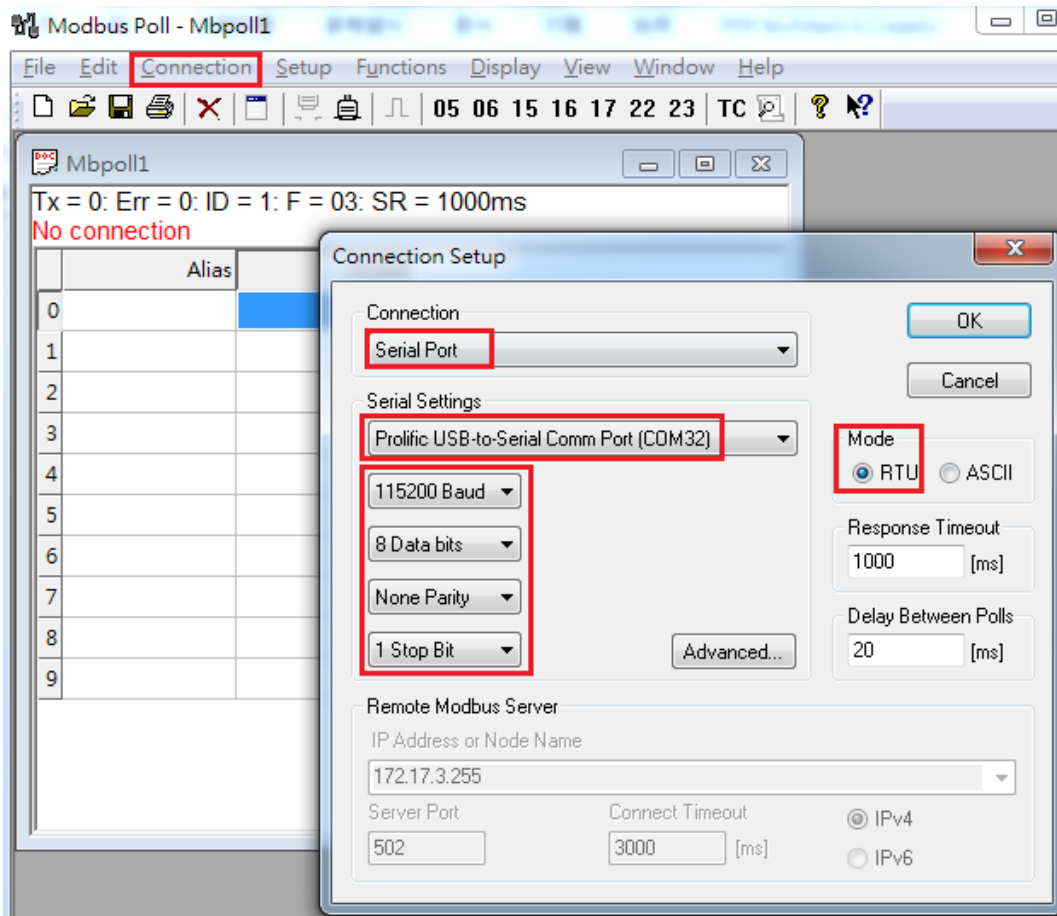

Figure 3-12 Com Port Parameters of “Modbus Poll” tool

<9> The CMD(3) data of HART device is shown like Figure 3-13.

	Alias	Value
		01300
0		4
1		--
2		70.1
3		--
4		70
5		--
6		70
7		--
8		70
9		--

Figure 3-13 The CMD(3) data of HART device

[4.2 - The firmware version of HRT-710 is older than v1.5]

[1] Add “User CMD(3)” with “Simple” format and then click “Save to Device” to save the new HART device setting to HRT-710 like Figure 3-14. The mapped Modbus start address and length of User CMD(3) data can be found in “Cmd In address” and “Cmd In size” field. In the example, they are 0 and 20.

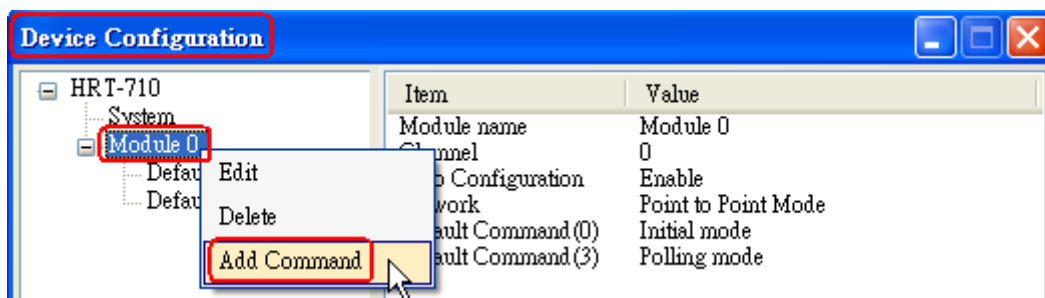

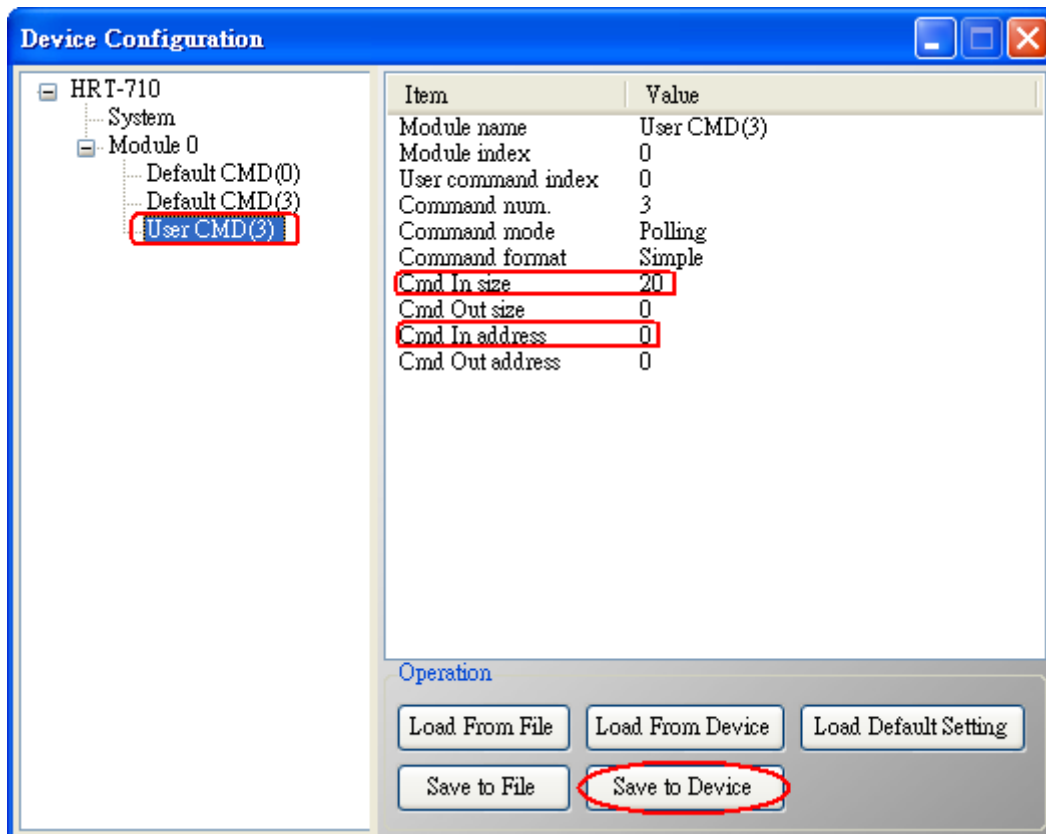
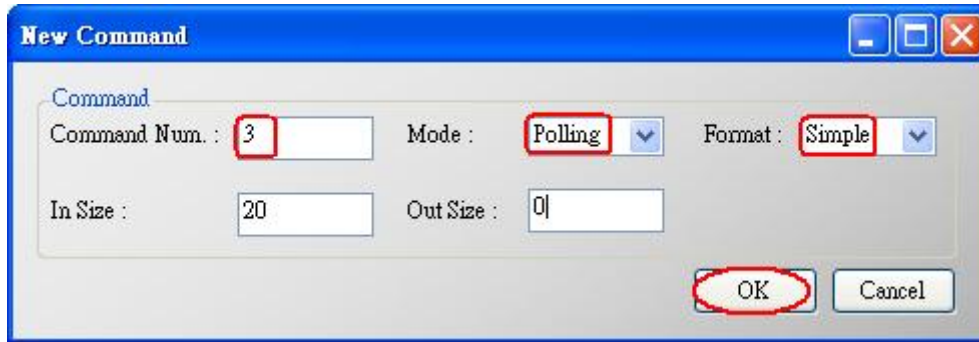

Figure 3-14 Add “User CMD(3)” to HRT-710

[2] The below MB/RTU client will use the “Modbus Poll” tool to show the CMD(3) data of HART device by polling Modbus address 0 ~ 9.

<1> Confirm the connection between HG_Tool and HRT-710 is disconnected.

<2> Set the “Modbus” parameters like Figure 3-15.

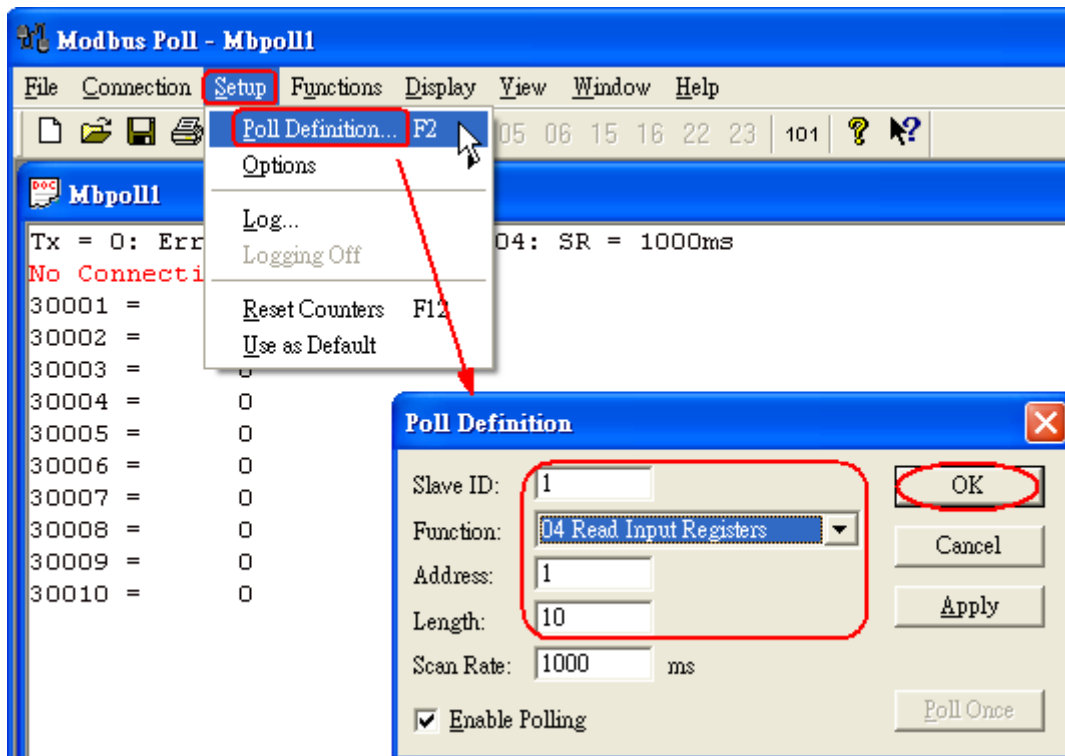

Figure 3-15 Modbus Parameters of “Modbus Poll” tool

<3> Set the “Display” mode to be “Float” format like Figure 3-16.

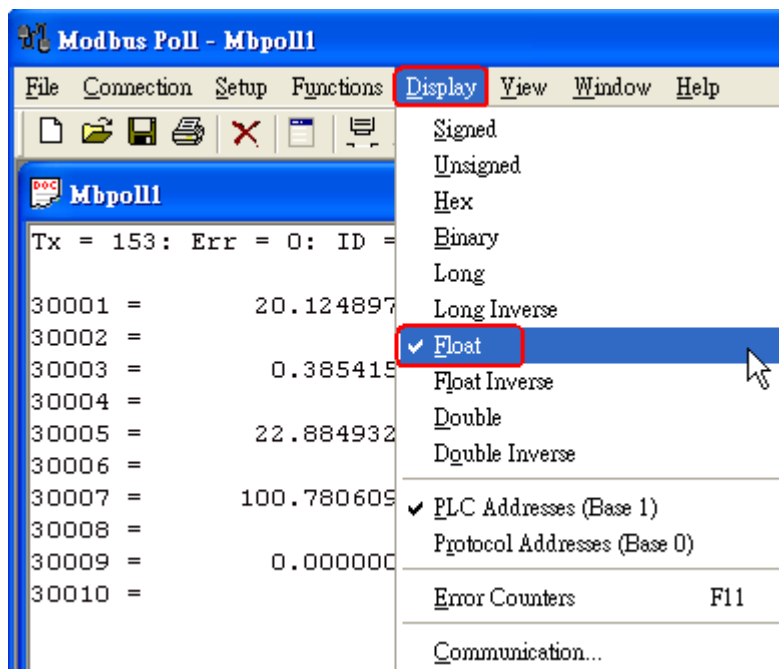

Figure 3-16 “Float” format of “Modbus Poll” tool

<4> Set the “Com Port” parameters and click “OK” button to connect to HRT-710 like Figure 3-17.

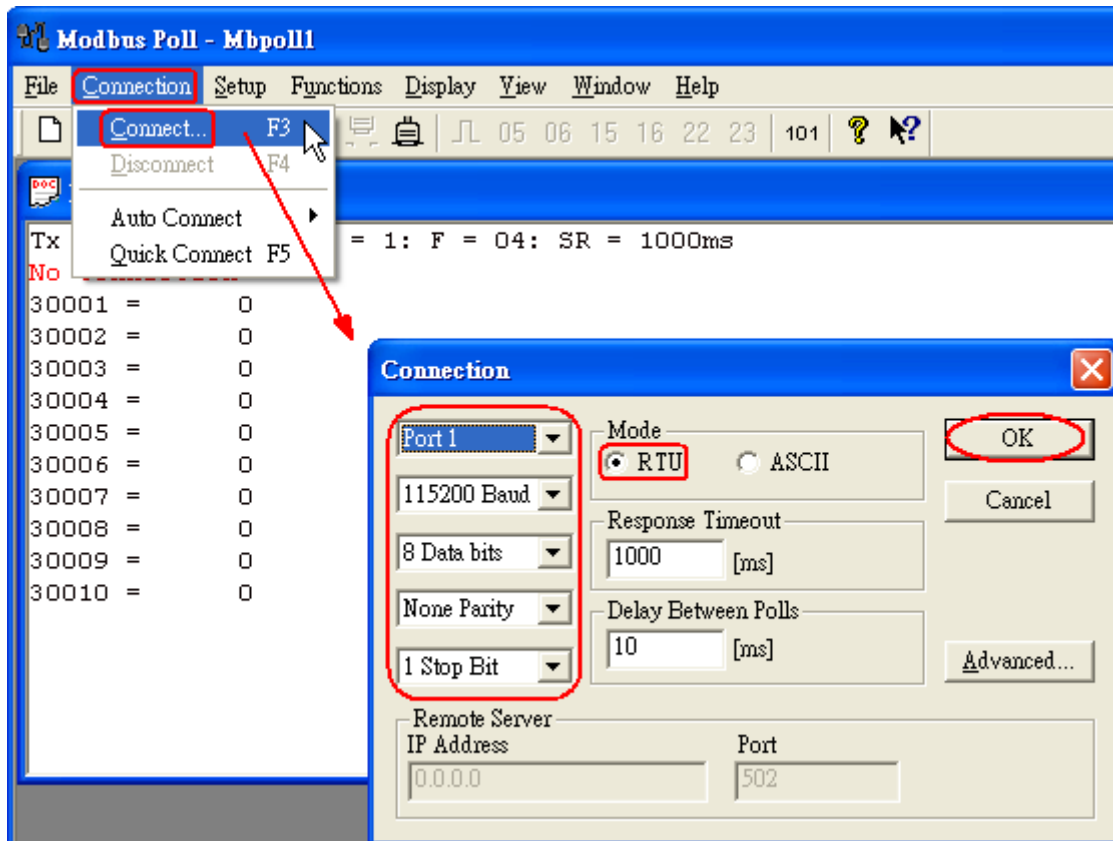

Figure 3-17 Com Port Parameters of “Modbus Poll” tool

<5> The CMD(3) data of HART device is shown like Figure 3-18.

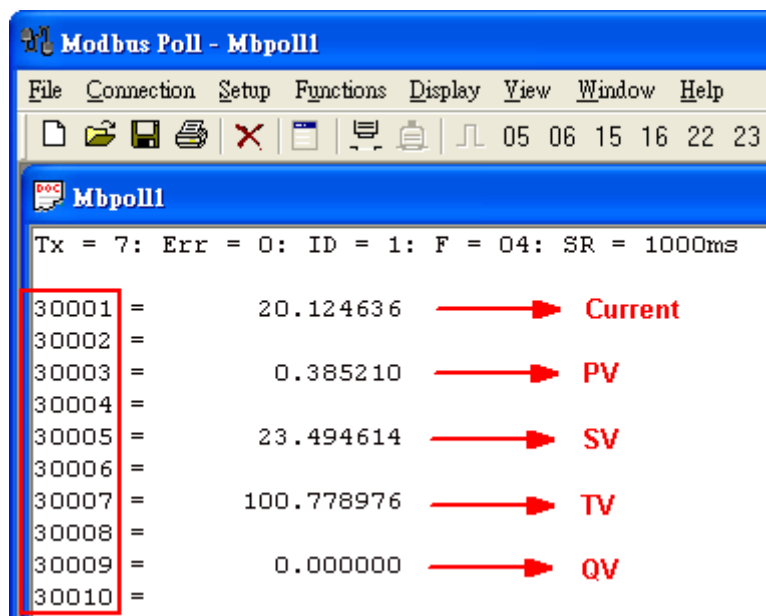

Figure 3-18 The CMD(3) data of HART device

[3] The below MB/RTU client will use the “ModScan” tool to show the CMD(3) data of HART device by polling Modbus address 1300 ~1309.

[Note]

1. The simple CMD(3) data format and value are shown as below.

[Index]	[Format]	[Description]
Byte 00~03:	float	Primary Variable Current
Byte 04~07:	float	Primary Variable
Byte 08~11:	float	Secondary Variable
Byte 12~15:	float	Tertiary Variable
Byte 16~19:	float	4th Variable

The 30001 and 30002 registers mean "Primary Variable Current (20.124636)"

The 30003 and 30004 registers mean "Primary Variable (0.385210)"

The 30005 and 30006 registers mean "Secondary Variable (23.494614)"

The 30007 and 30008 registers mean "Tertiary Variable (100.778976)"

The 30009 and 30010 registers mean "4th Variable (0)"

Q04 : How to update the firmware of HRT-710 ?

A04:

[For HRT-710 hardware v1.1 or firmware v1.1 or below]

The firmware update function is not supported for users and please contact your local dealer.

[For HRT-710 hardware v1.2 and firmware v1.2 or newer]

The firmware update function is supported for users. Please follow the below steps.

※ **HW_v1.xx just supports firmware v1.xx.**

[For HRT-710 hardware v2.2 and firmware v2.0 or newer]

The firmware update function is supported for users. Please follow the below steps.

※ **HW_v2.xx (casing with 'RevB' characters) just supports firmware v2.xx.**

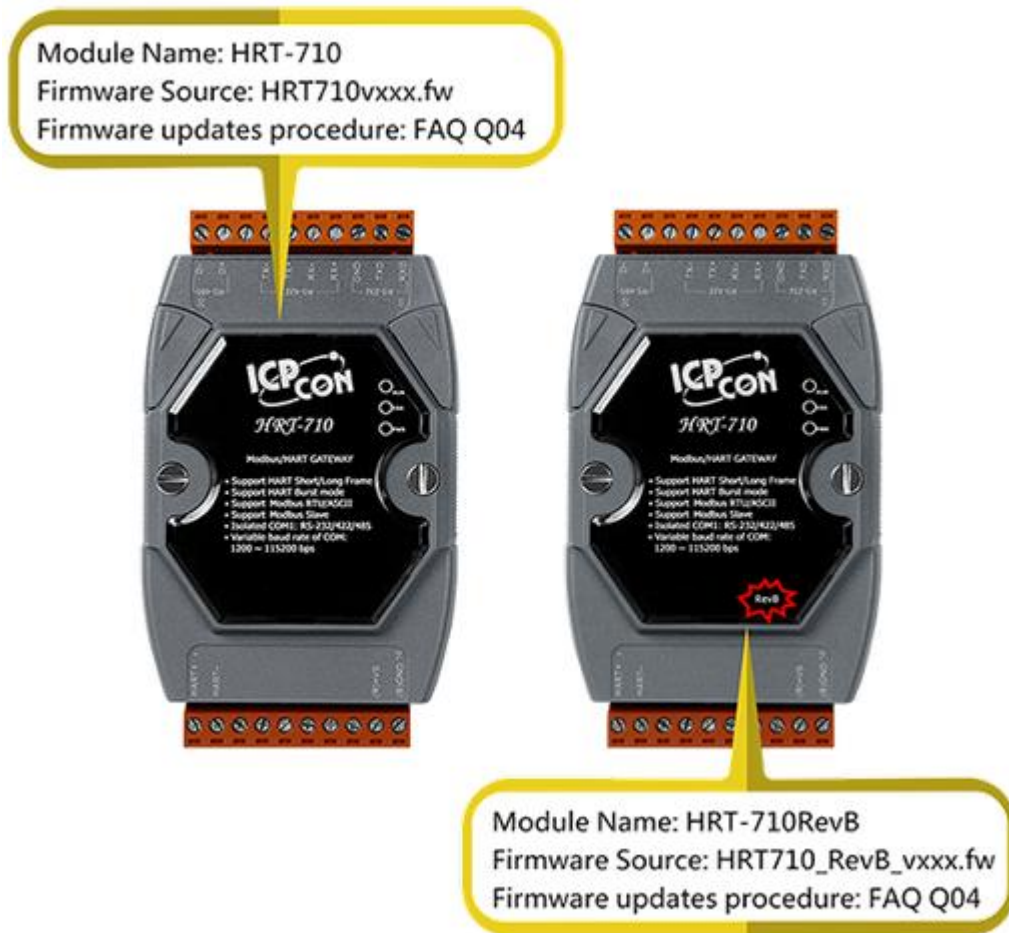

If you accidentally update the firmware to the wrong hardware (Ex. update version 2.0 to hardware version v1.2), it will cause a boot abnormality.

Please refer to the following procedure to update the correct firmware again.

- (1) Download the newest firmware of HRT-710. (Download from <https://www.icpdas.com/en/download/show.php?num=2907&model=HRT-710>)
- (2) Turn off the power and open the shell of HRT-710. Then connect the pin 2 & 3 of JP5 together like Figure 4-1.

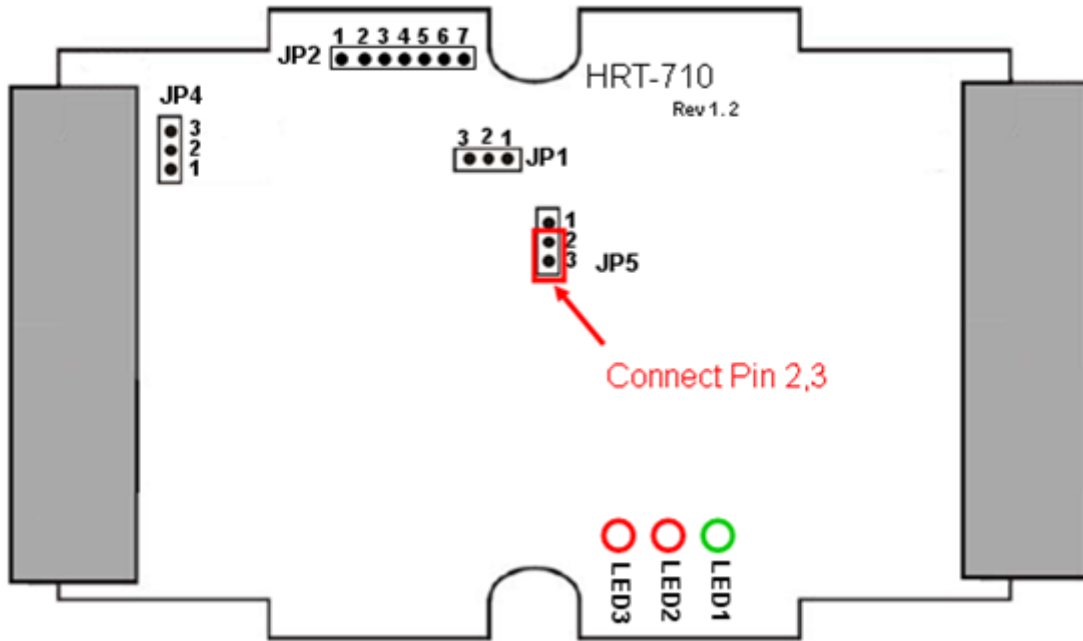

Figure 4-1 Connect pin 2 & 3 of JP5 together

- (3) Connect RS-232 cable between PC and HRT-710 and turn on the power of HRT-710 (LED 1,2,3 will flash every second => Firmware Update Mode) like Figure 4-2.

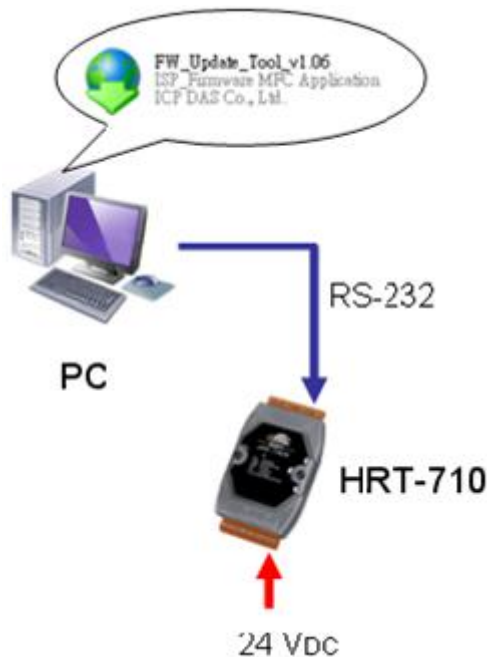

Figure 4-2 RS-232 Connection between PC and HRT-710

- (4) Run “FW_Update_Tool” like Figure 4-3 (Download from : <https://www.icpdas.com/tw/download/show.php?num=4892&model=HRT-710>).
- [1] Choose “COM” option and select “Com Port number”.
 - [2] Click “Browser” button to choose the firmware of HRT-710.
 - [3] Click “Firmware Update” button to start firmware update process.
 - [4] Wait for "Firmware Update Success" message.

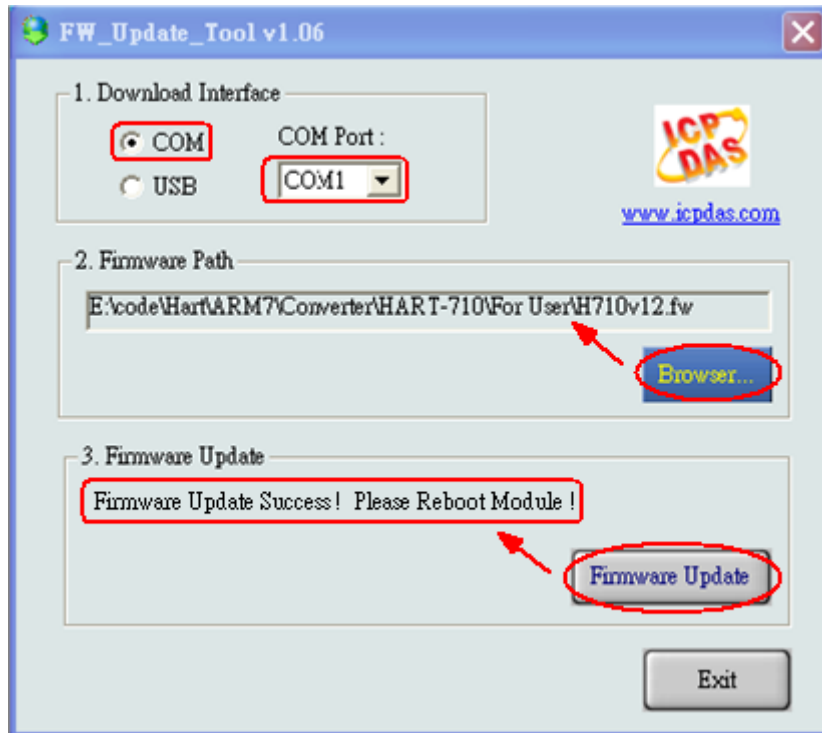

Figure 4-3 “FW_Update_Tool”

- (5) Turn off the power and connect the pin 1 & 2 of JP5 together like Figure 4-4.

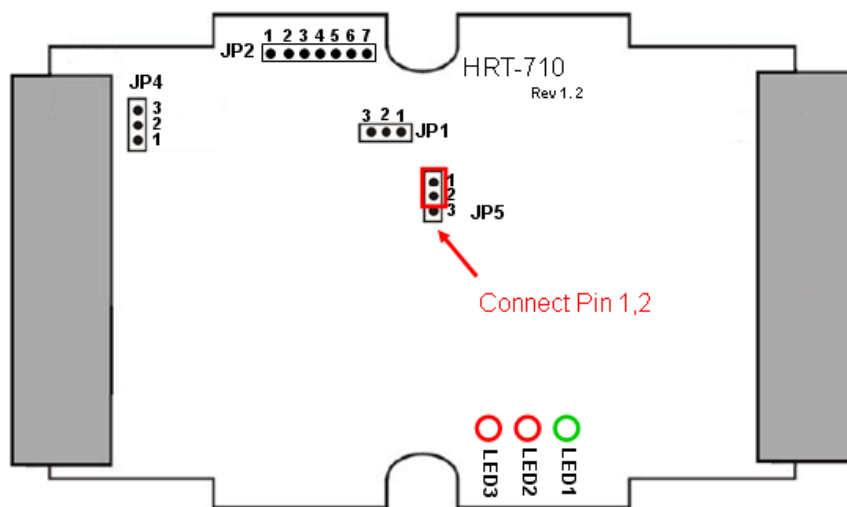

Figure 4-4 Connect pin 1 & 2 of JP5 together

- (6) Close the shell and turn on the power of HRT-710. Then users can check the firmware

version of HRT-710 by using “HG_Tool” like Figure 4-5.

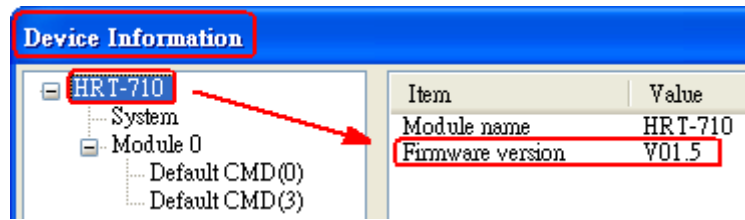

Figure 4-5 Firmware Version of HRT-710

[Note]

1. If the result of firmware update process always failed, please follow the below steps.
 - [1] Turn off the power and open the shell of module.
 - [2] Adjust the jumper of **JP1 to the position 2,3**.
 - [3] Turn on the power of module and test firmware update again.
 - [4] When firmware update process succeeds, adjust the jumper of JP1 to the position 1,2.

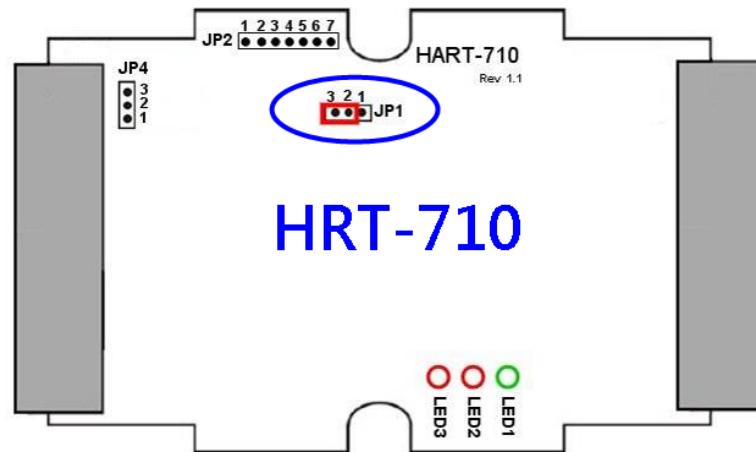

Figure 4-6: JP1 of HRT-710

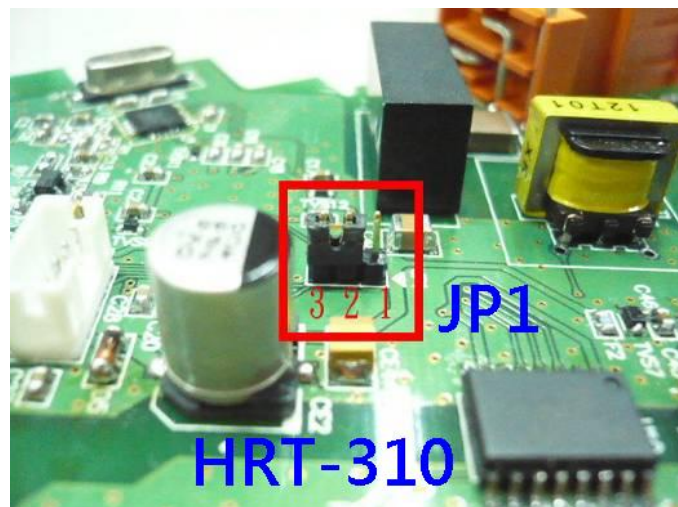
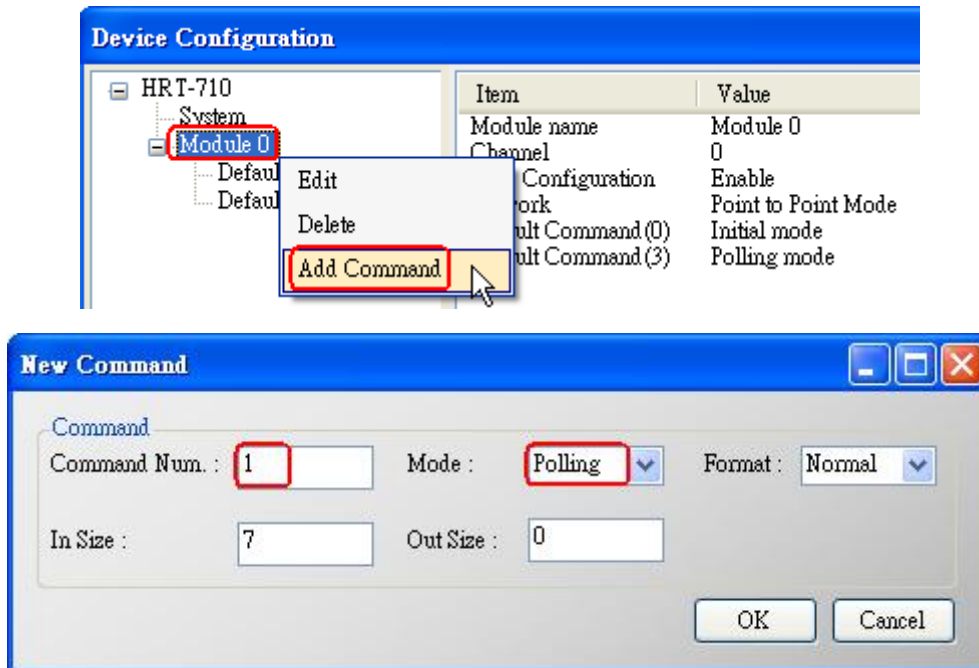

Figure 4-7: JP1 of HRT-310

Q05 : How to read HART device CMD1 data with standard format by Modbus ?

A05:

- (1) By using “HG_Tool” to add “User CMD(1)” of HART device and save settings to HRT-710. The Modbus start address and length of the “User CMD(1)” will show in the “Cmd In address” and “Cmd In size” field like Figure 5-1. In the example they are 0 and 7 (byte count=7 => word count=4).



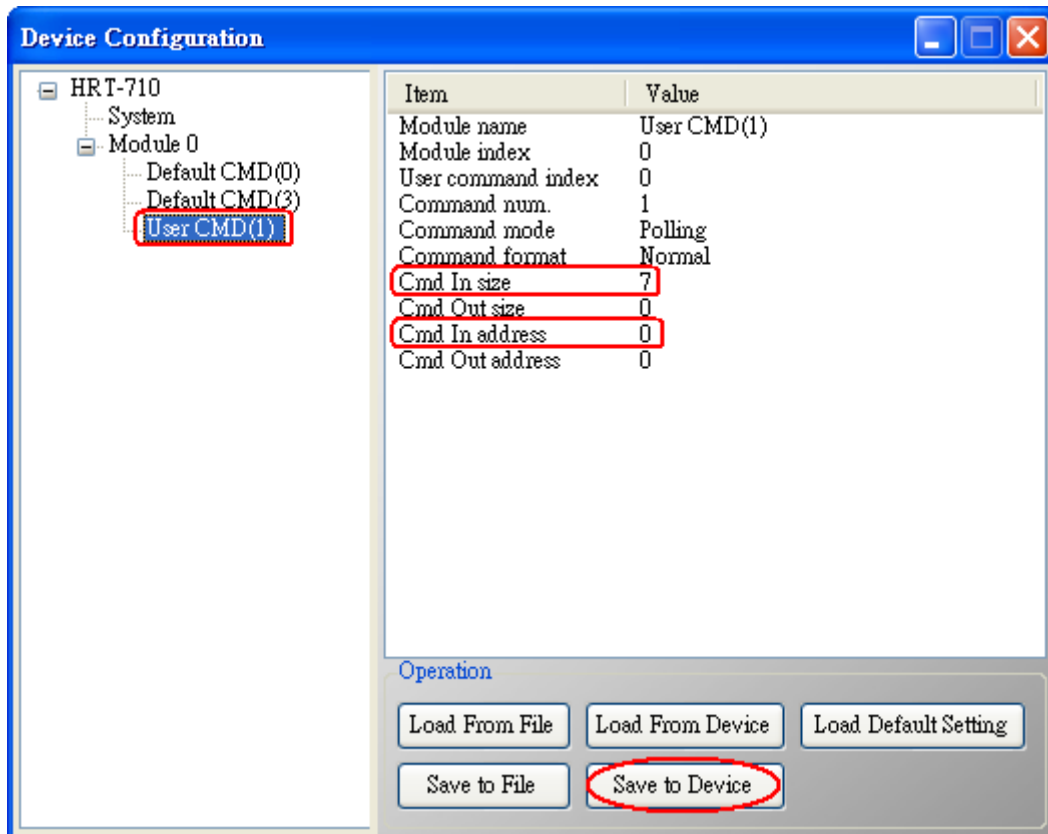

Figure 5-1 Add “User CMD(1)” of HART device to HRT-710

- (2) The below demo will use the free MB/RTU tool provided by ICP DAS to show HART command 1 data. (Download from http://ftp.icpdas.com.tw/pub/cd/8000cd/napdos/modbus/modbus_utility/)
- (3) Run “MB/RTU” tool. Set the com port settings the same with HART-710 (Baud Rate / Data Bits / Stop Bits / Parity) and then click “Open” button to connect to HRT-710 like Figure 5-2.
- (4) Input “1 4 0 0 0 4” in “Command” field and click “Send Command” button to send the modbus command. The HART command 1 data will be received in “Responses” field => “01 04 08 00 00 3E 0C 20 C5 00 A4 2A 94” like Figure 5-2.
 Send Modbus Command : 01 04 00 00 00 04 F1 C9
 Get Response : 01 04 08 00 00 3E 0C 20 C5 00 A4 2A 94

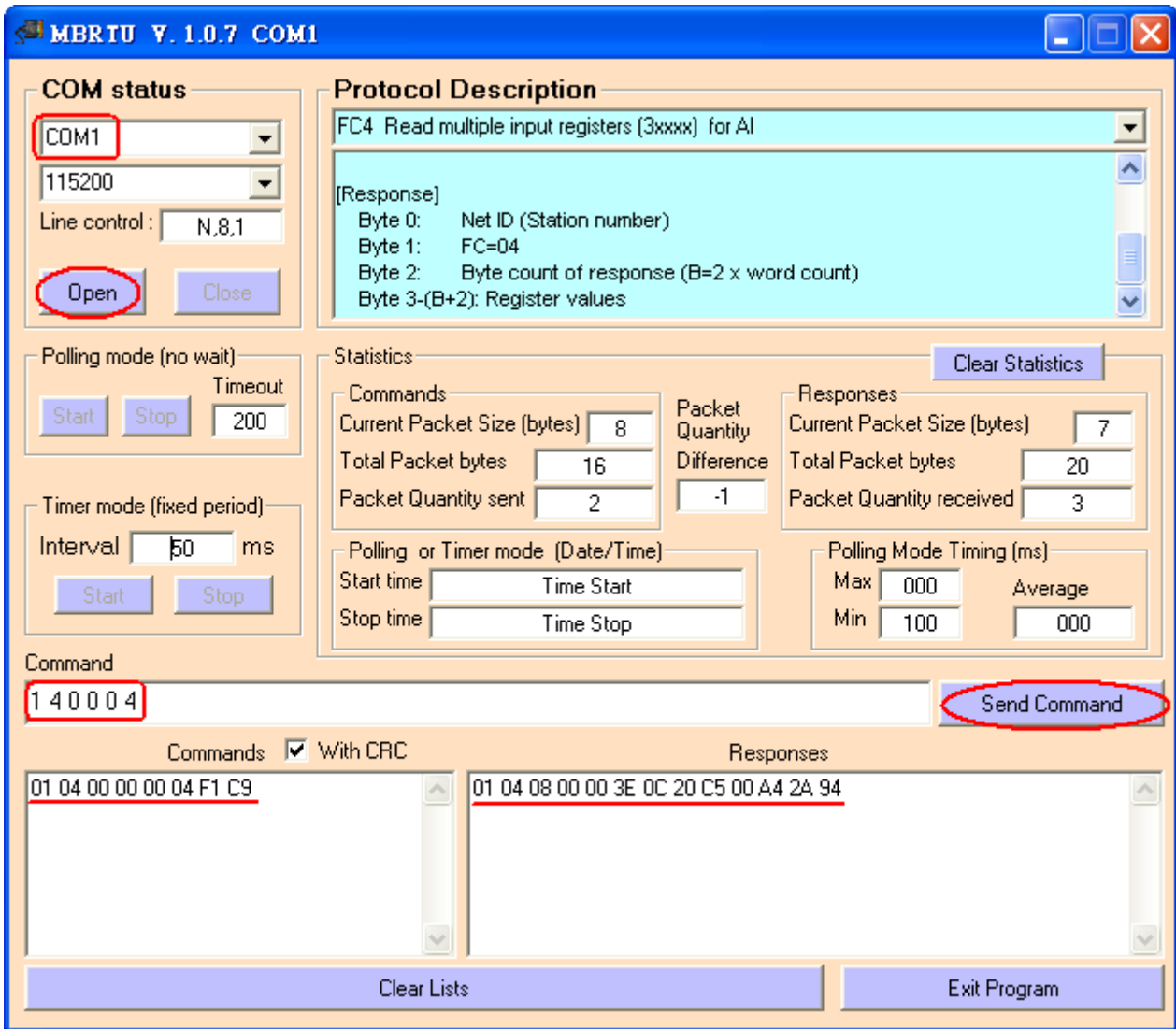

Figure 5-2 Receive HART Command 1 data

(5) Parse the Modbus response data.

Response Data => 01 04 08 00 00 3E 0C 20 C5 00 A4 2A 94

Register data => 00 00 3E 0C 20 C5 00 A4

Because the unit of HART-710's database is byte and the unit of Modbus register is word and the Modbus register is composed of database's byte and the order is low byte first.

(For example: Modbus register0 = 0x3412, database byte0 = 0x12, byte1 = 0x34).

So we need to change the byte order.

So the data will be 00 00 0C 3E C5 20 A4 00.

According to the data count is 7, so the actual data will be 00 00 0C 3E C5 20 A4

About the format of HART Command 1, it is shown as below.

Command 1: Read Primary Variable

Request data bytes: None

Response data bytes: 2+5 = 7

Index format description

Byte 0: uint8 Response code 1

Byte 1: uint8 Response code 2

Byte 2: uint8 Unit code

Byte 3~6: float Primary Variable

So the data of HART command 1 is parsed as below.

Response code1 = 0x00

Response code2 = 0x00

Primary Variable Unit code = 0x0C (kPA)

Primary Variable = 0x3E 0xC5 0x20 0xA4 (0.385 => IEEE754)

Q06 : How to read HART device CMD 3 data with standard format by Modbus ?

A06:

- (1) When adding a new HART device to HRT-710, the “Default CMD(3)” will be added automatically. The Modbus start address and length of the “Default CMD(3)” will show in the “Cmd In address” and “Cmd In size” field like Figure 6-1. In the example they are 1236 (For MB Addr = 618 = 0x026A) and 26 (byte count=26 => word count=13).

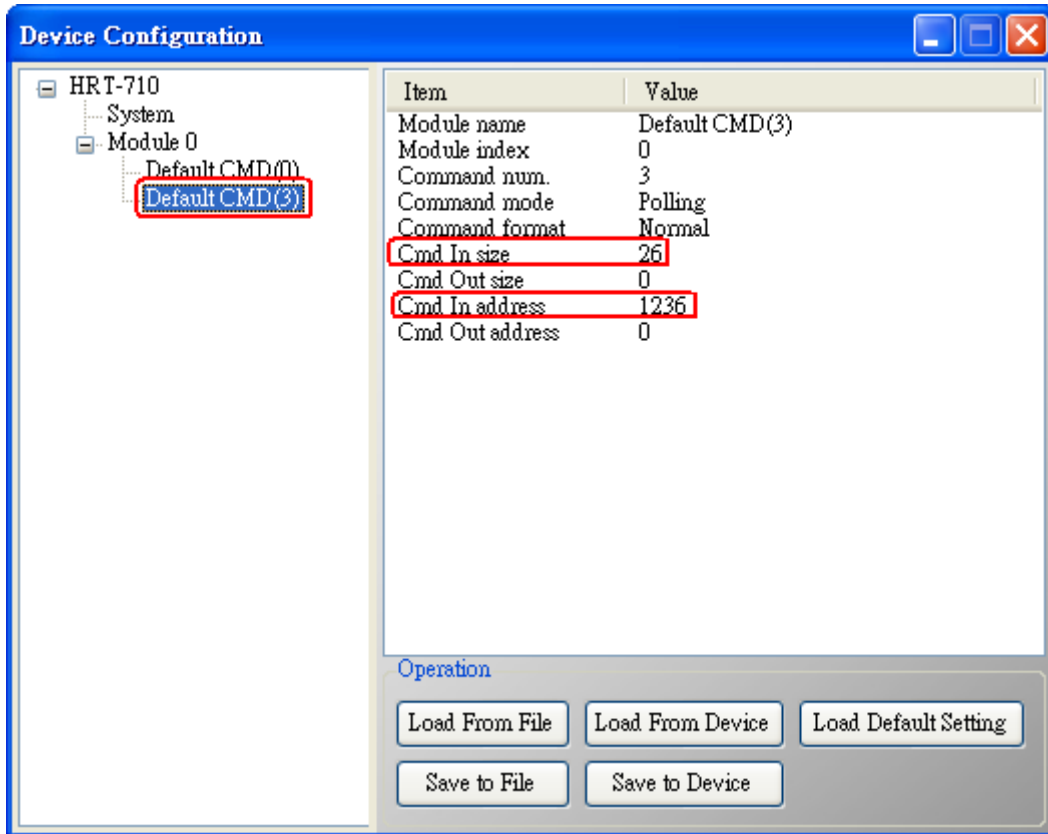

Figure 6-1 “Default CMD(3)” of HART device in HRT-710

- (2) The below demo will use the free MB/RTU tool provided by ICP DAS to show HART command 1 data. (Download from http://ftp.icpdas.com.tw/pub/cd/8000cd/napdos/modbus/modbus_utility/)
- (3) Run “MB/RTU” tool. Set the com port settings the same with HART-710 (Baud Rate / Data Bits / Stop Bits / Parity) and then click “Open” button to connect to HRT-710 like Figure 6-2.
- (4) Input “01 04 02 6A 00 0D” in “Command” field and click “Send Command” button to send the Modbus command. The HART command 3 data will be received in “Responses” field => “01 04 1A 00 00 A1 41 22 01 3E 0C C5 C5 20 B0 B6 41 C0 78 42 39 91 C9 00 C5 00 00 00 00 E5 B0” like Figure 6-2.

Send Modbus Command : 01 04 02 6A 00 0D 10 6B

Get Response : 01 04 1A 00 00 A1 41 22 01 3E 0C C5 C5 20 B0 B6 41 C0 78 42 39 91 C9
00 C5 00 00 00 00 E5 B0

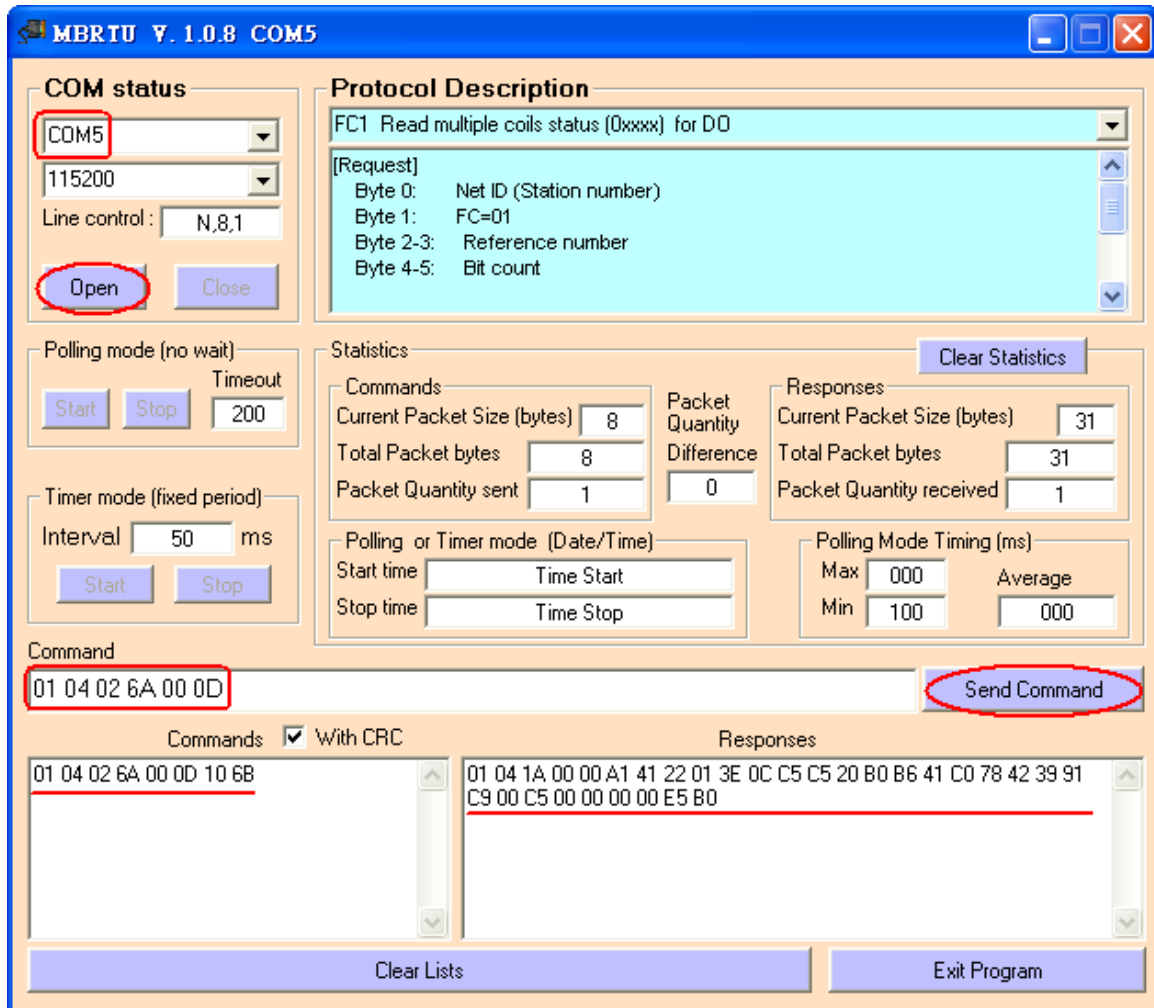

Figure 6-2 Receive HART Command 3 data

(5) Parse the Modbus response data.

Response Data => 01 04 1A 00 00 A1 41 22 01 3E 0C C5 C5 20 B0 B6 41 C0 78 42 39 91 C9 00 C5 00 00 00 00 E5 B0

Register data =>

00 00 A1 41 22 01 3E 0C C5 C5 20 B0 B6 41 C0 78 42 39 91 C9 00 C5 00 00 00 00

Because the unit of HART-710's database is byte and the unit of Modbus register is word and the Modbus register is composed of database's byte and the order is low byte first.

(For example: Modbus register0 = 0x3412, database byte0 = 0x12, byte1 = 0x34).

So we need to change the byte order. So the data will be as below.

00 00 41 A1 01 22 0C 3E C5 C5 B0 20 41 B6 78 C0 39 42 C9 91 C5 00 00 00 00 00

About the format of HART Command 3, it is shown as below.

Command 3: Read Dynamic Variables and P.V. Current

Request data bytes: None

Response data bytes: $2+24 = 26$

Index format description

Byte 2~5: float Primary Variable Current

Byte 6: uint8 Primary Variable Unit code

Byte 7~10: float Primary Variable

Byte 11: uint8 Secondary Variable Unit code

Byte 12~15: float Secondary Variable

Byte 16: uint8 Tertiary Variable Unit code

Byte 17~20: float Tertiary Variable

So the data of HART command 3 is parsed as below.

Response code1 = 0x00

Response code2 = 0x00

Primary Variable Current = 0x41 0xA1 0x01 0x22 (20.125553)

Primary Variable Unit code = 0x0C (kPA)

Primary Variable = 0x3E 0xC5 0xC5 0xB0 (0.386274)

Secondary Variable Unit code = 0x20 (degC)

Secondary Variable = 0x41 0xB6 0x78 0xC0 (22.808960)

Tertiary Variable Unit code = 0x39 (Percent)

Tertiary Variable = 0x42 0xC9 0x91 0xC5 (100.784706)

4th Variable Unit code = 0x00 (???)

4th Variable = 0x00 0x00 0x00 0x00 (0)

Q07 : How to know the connection status between HRT-710 and HART devices ?

A07: (2013/01/30)

The communication status description of HART command in HRT-710 is as below.

- 0 — No error
- 1 — Means the command has never be executed
- 2 — Receive timeout, can't receive any HART data from HART device.
- 3 — Receive HART data is too short
- 4 — The delimiter of HART data has some error
- 5 — The address (the bit of master type) of HART data has some error
- 6 — The address (the bit of burst mode) of HART data has some error
- 7 — The command of HART data has some error
- 8 — The parity of HART data has error.
- 9 — The communication with HART slave device has some error and The error messages are recorded in the responses codes.

[Ex1 => The Default CMD(3) of “HART Device 0 & 1” in HRT-710 is Polling Mode]

< 1. The setting of SWAP Mode is “None” (without Byte and WORD swap) >

(1) Address 1000 (Unit: WORD) : Show the comm. status of “Device 0”.

[1] High Byte : “The comm. status of Default CMD(3) in device 0.

[2] Low Byte : “The comm. status of Default CMD(0) in device 0.

(2) Address 1001 (Unit: WORD) : Show the comm. status of “Device 1”.

[1] High Byte : “The comm. status of Default CMD(3) in device 1.

[2] Low Byte : “The comm. status of Default CMD(0) in device 1.

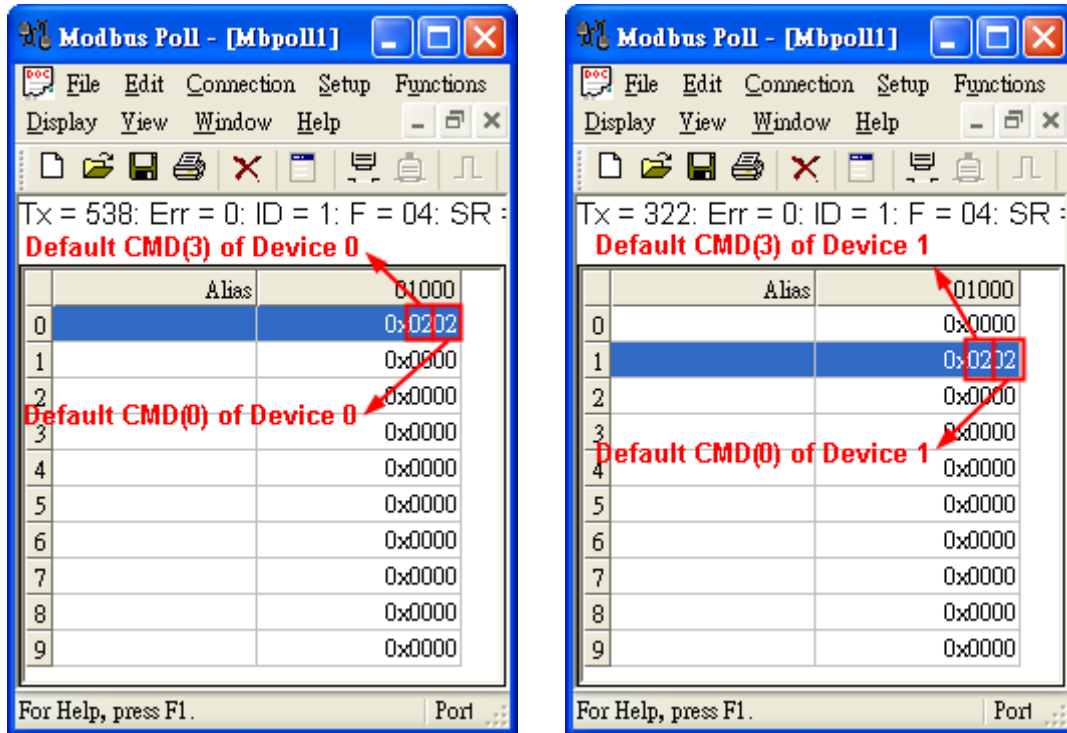

Figure 7-1.1 The status of Default CMD(0&3) in Device 0 and Device 1

< 2. The setting of SWAP Mode is “W&B” (with Byte and WORD swap) >

(1) Address 1001 (Unit: WORD) : Show the comm. status of “Device 0”.

[1] High Byte : “The comm. status of Default CMD(0) in device 0.

[2] Low Byte : “The comm. status of Default CMD(3) in device 0.

(2) Address 1000 (Unit: WORD) : Show the comm. status of “Device 1”.

[1] High Byte : “The comm. status of Default CMD(0) in device 1.

[2] Low Byte : “The comm. status of Default CMD(3) in device 1.

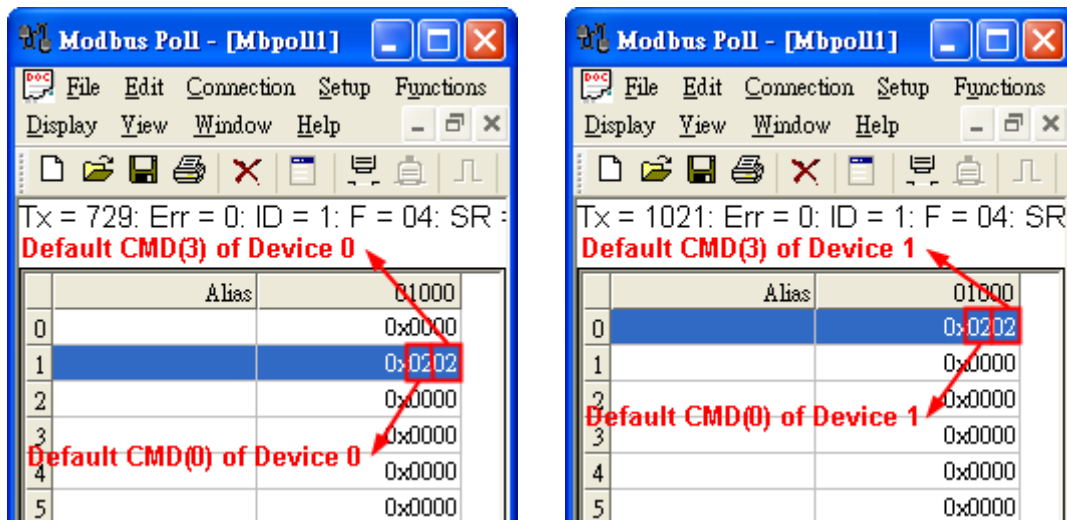

Figure 7-1.2 The status of Default CMD(0&3) in Device 0 and Device 1

In the Figure 7-1, the status of the Default CMD(3) in device 0 is 0x02 and it means that the HART device for the Default CMD(3) is disconnected from HRT-710. (In the Figure 7-1, the status of the Default CMD(0) is 0x02, too.)

[Ex2 => The “User CMD Index = 0” is Polling Mode]

< The setting of SWAP Mode is “None” (No Byte and WORD swap) >

(1) By using the Lo-Byte value of MB address 1050 (unit:WORD) (refer to sector 4.3 – Modbus / HART Mapping Table), users can get the communication status of the User CMD Index = 0.

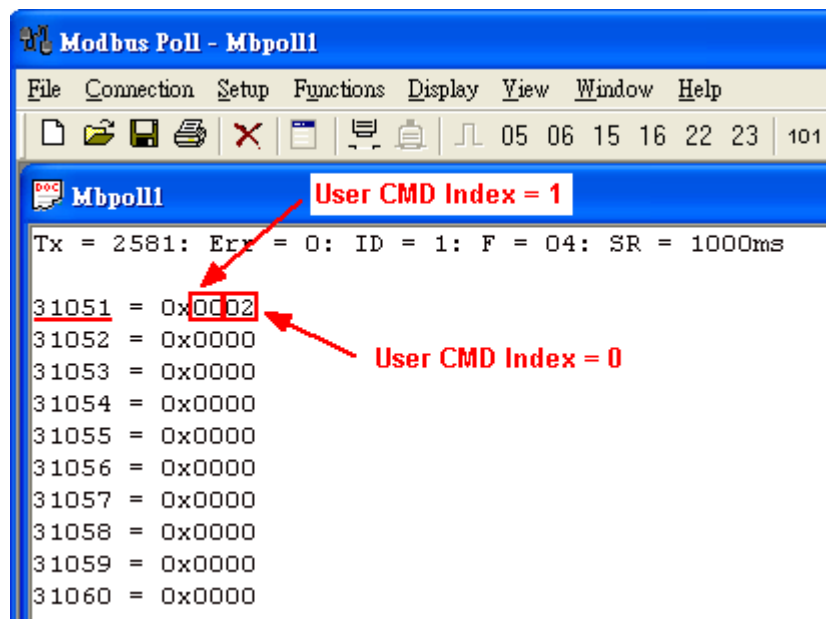

Figure 7-2 The status of the User CMD Index = 0&1

In the Figure 7-2, the status of the User CMD Index = 0 is 0x02. It means that the HART device for the User CMD Index = 0 is disconnected from HRT-710.

[Ex3 => The “User CMD Index = 1” is Polling Mode]

< The setting of SWAP Mode is “None” (No Byte and WORD swap) >

(1) By using the Hi-Byte value of MB address 1050 (unit:WORD) (refer to sector 4.3 – Modbus / HART Mapping Table), users can get the communication status of the User CMD Index = 1.

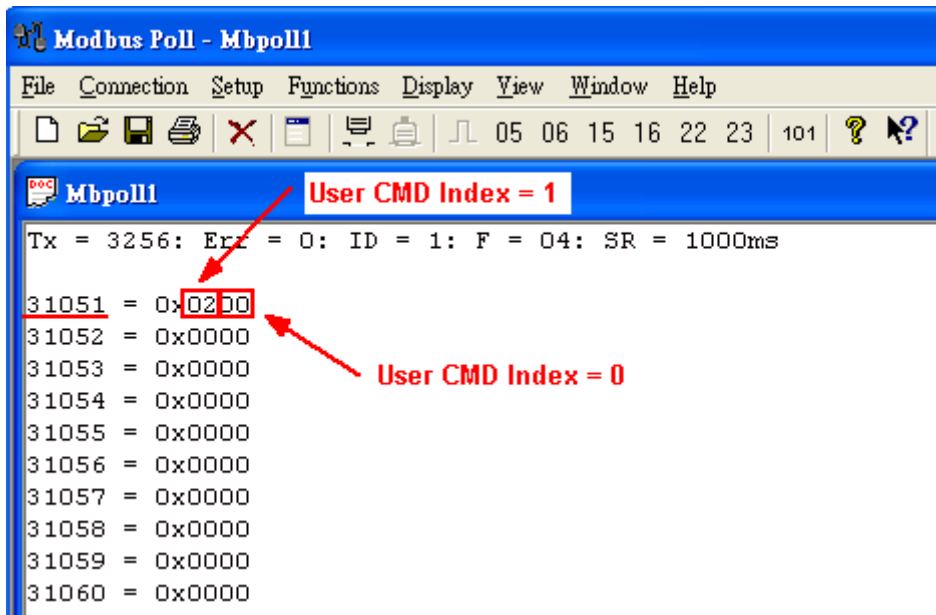

Figure 7-3 The status of the User CMD Index = 0&1

In the Figure 7-3, the status of the User CMD Index = 1 is 0x02. It means that the HART device for the User CMD Index = 1 is disconnected from HRT-710. (In the Figure 7-3, the status of the User CMD Index = 0 is 0x00. It means that the HART device for the User CMD Index = 0 is connected to HRT-710.)

[Note]

(1) Read the HART device status with Modbus Single Address :

[1] No matter “WORD Swap” enabled or not, the HART device status address will be always as below. The method will be easy for users.

[Default CMD(0&3) Status Data]		
3E8	1000	“Default CMD(0&3)” status of “Device 0”
3E9	1001	“Default CMD(0&3)” status of “Device 1”
3EA	1002	“Default CMD(0&3)” status of “Device 2”
3EB	1003	“Default CMD(0&3)” status of “Device 3”
3EC	1004	“Default CMD(0&3)” status of “Device 4”
3ED	1005	“Default CMD(0&3)” status of “Device 5”
3EE	1006	“Default CMD(0&3)” status of “Device 6”
3EF	1007	“Default CMD(0&3)” status of “Device 7”
3F0	1008	“Default CMD(0&3)” status of “Device 8”
3F1	1009	“Default CMD(0&3)” status of “Device 9”
3F2	1010	“Default CMD(0&3)” status of “Device 10”

[Default CMD(0&3) Status Data]		
3F3	1011	“Default CMD(0&3)” status of “Device 11”
3F4	1012	“Default CMD(0&3)” status of “Device 12”
3F5	1013	“Default CMD(0&3)” status of “Device 13”
3F6	1014	“Default CMD(0&3)” status of “Device 14”
3F7	1015	“Default CMD(0&3)” status of “Device 15”

(2) Read the HART device status with Modbus Multiple Address :

[1] If the “WORD Swap” is enabled with Modbus multiple address for reading, then the status address for HART devices will be different from the above table. If the starting Modbus address is different, then the status address for HART devices will be also different. The result will be as the below table.

Swap Type	WORD swap disabled		WORD swap enabled	
	From 999	From 1000	From 999	From 1000
Modbus Start Addr	From 999	From 1000	From 999	From 1000
Dev00_Status Addr	1000	1000	999	1001
Dev01_Status Addr	1001	1001	1002	1000
Dev02_Status Addr	1002	1002	1001	1003
Dev03_Status Addr	1003	1003	1004	1002
Dev04_Status Addr	1004	1004	1003	1005
Dev05_Status Addr	1005	1005	1006	1004
Dev06_Status Addr	1006	1006	1005	1007
Dev07_Status Addr	1007	1007	1008	1006
Dev08_Status Addr	1008	1008	1007	1009
Dev09_Status Addr	1009	1009	1010	1008
Dev10_Status Addr	1010	1010	1009	1011
Dev11_Status Addr	1011	1011	1012	1010
Dev12_Status Addr	1012	1012	1011	1013
Dev13_Status Addr	1013	1013	1014	1012
Dev14_Status Addr	1014	1014	1013	1015
Dev15_Status Addr	1015	1015	1016	1014

Q08 : How to integrate Active and Passive HART devices in multi-drop network ?

A08: (2013/12/06)

1. If there are more than 7 HART devices in the HART network, users need to disable the internal resistor (250 Ohm, 1/4W) of HRT-710 (adjust JP4 to be pin2 and pin3, refer to the section 2.6 for detailed). Then add the external resistor (250 Ohm, 1W) in HART network.
2. The HART wiring of the Active and Passive HART devices, please refer to the figure 8-1.

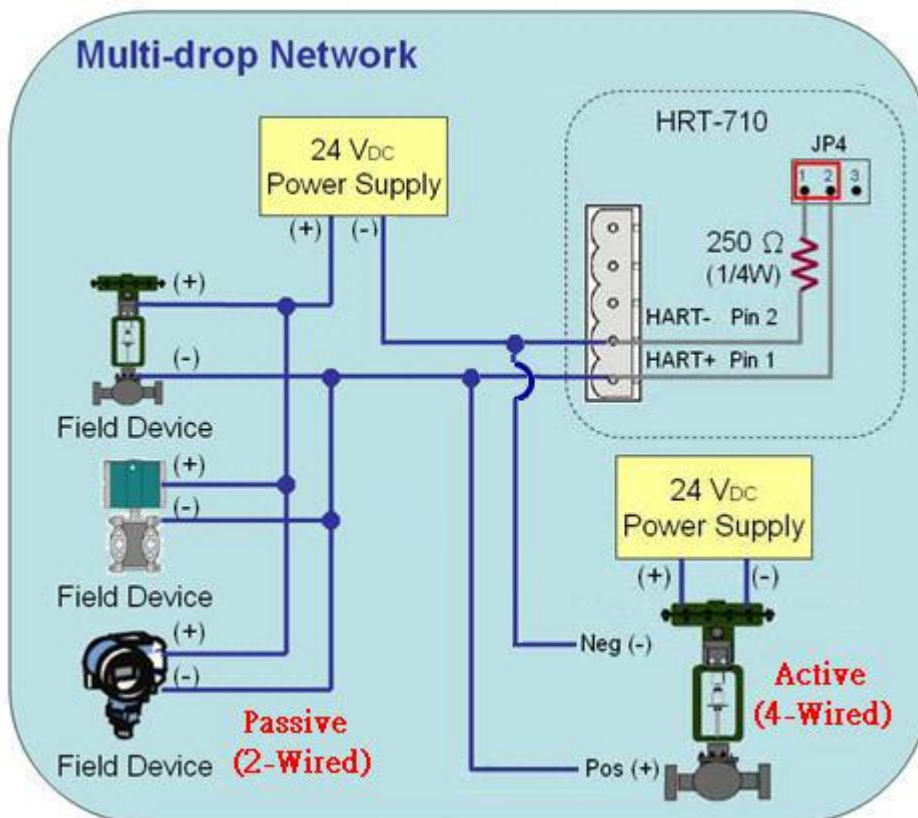

Figure 8-1 The HART wiring of the Active and Passive HART devices

Q09 : How to integrate multiple HRT-710 in the same RS-485 ?

A09: (2013/12/06)

[Case Example]

A user wants to integrate 20 HART devices (Ultrasonic Water Level) in the same RS-485 network via Modbus RTU communication and HART network between HRT-710 and HART device is point to point.

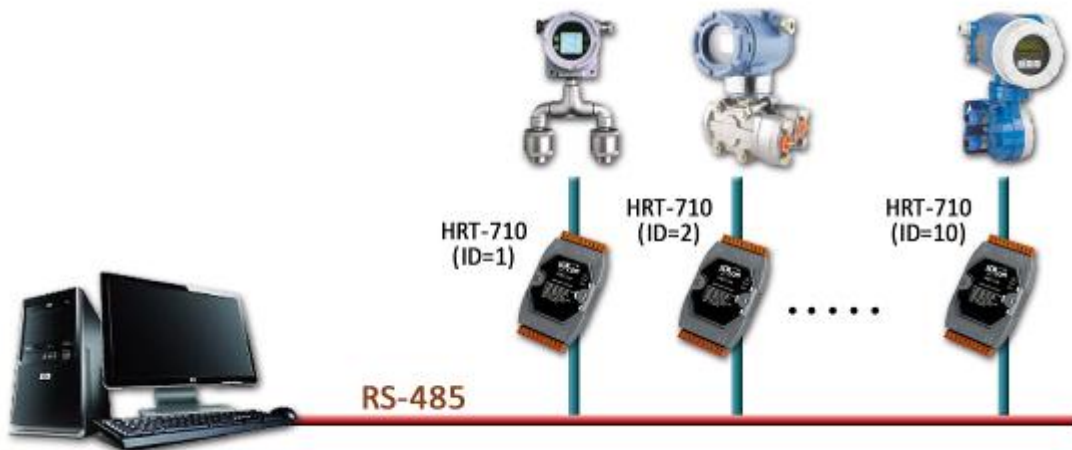

[Solution]

< Hardware >

We suggest the user to use 20 HRT-710 modules to connect to 20 HART devices with point to point wiring.

< Software >

1. Set the RS-485 station No. (Net ID) of these twenty HRT-710 modules from 1 to 20. Please follow the below steps.
 - (1) Run the “HG_Tool” and connect to HRT-710.
 - (2) Click the “Device Configuration” item and then right click on the “System” item to choose the “Edit” option.

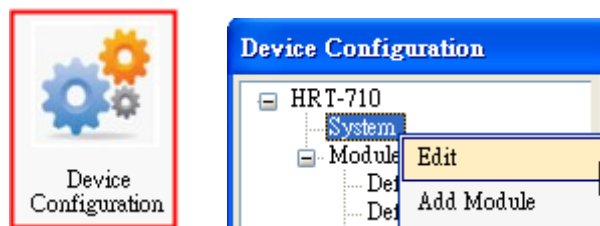

Figure 9-1 “Device Configuration” Screen

- (3) In the “System Edit” screen, please input the RS-485 station No. of HRT-710 in the “Net ID” field.

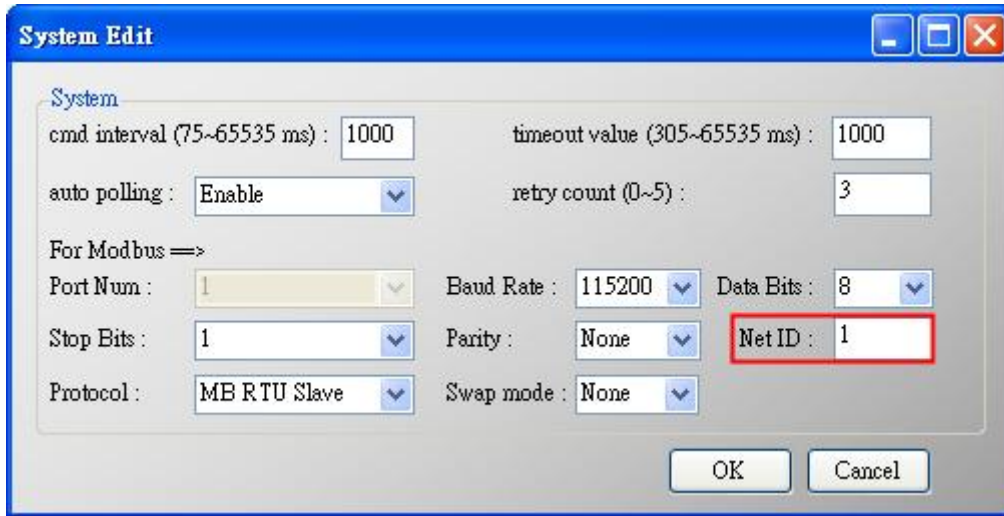

Figure 9-2 Setting for the RS-485 Station No. of HRT-710

- (4) After the settings are finished, in the “Device Configuration”, please click the “Save to Device” button to save the parameters to HRT-710.

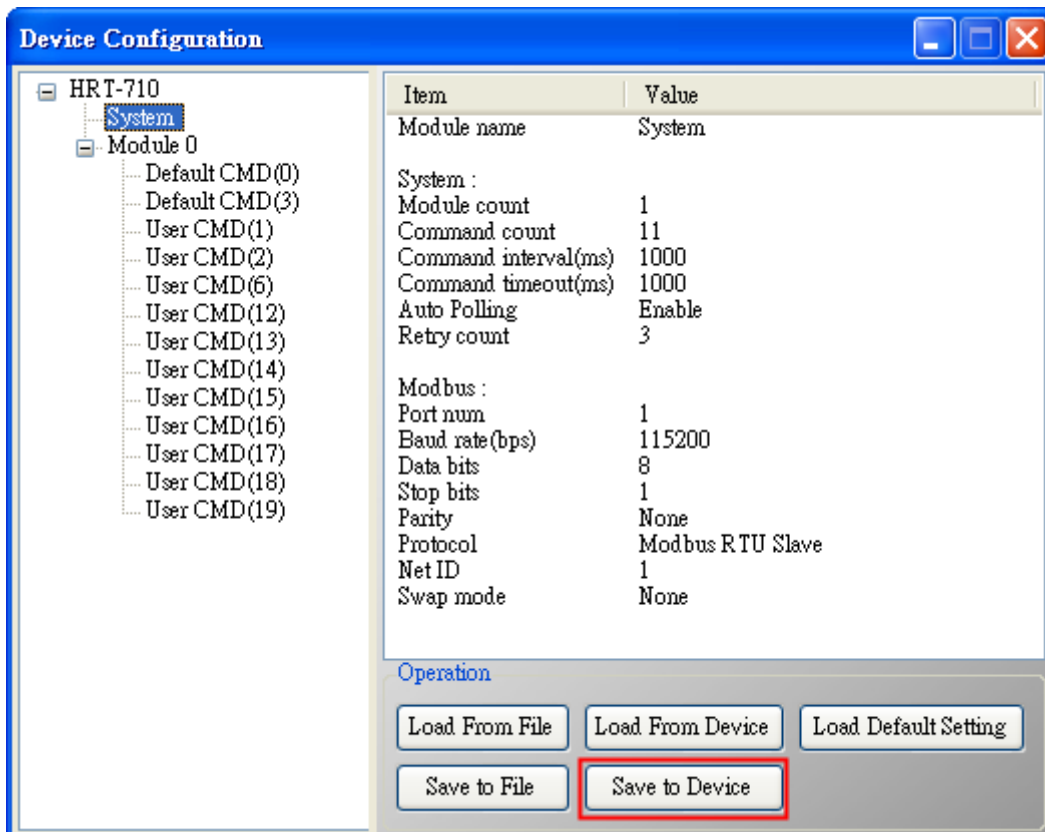

Figure 9-3 Save the parameters to HRT-710

=> As a result, these twenty HRT-710 modules can be integrated in the same RS-485 network to gather these HART devices information.

Q10 : How to integrate HART comm. device with RS-232 hardware interface ?

A10: (2013/12/06)

[Case Example]

A user wants to integrate HART communication device (Flowmeter, Mobrey MCU900) with RS-232 hardware interface.

[Solution]

< Hardware >

We suggest the user to use HRT-710 and I-7570 to do that and the wiring for this case is like figure 10-1.

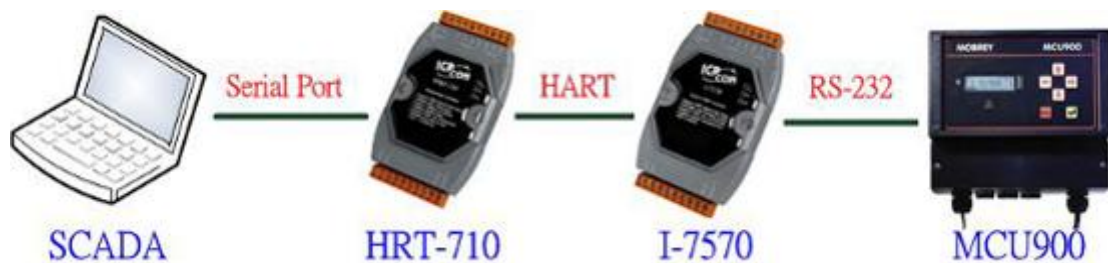

Figure 10-1 The Hardware Wiring for MCU900

< Software >

Please refer to the steps in the Q01, Q02 and Q03 of HRT-710 FAQ to integrate HART device information to SCADA.

[Note]

In MCU900, please choose HART protocol not “Mobreyspecific LogDownload” protocol.

Q11 : How to add the HART Device-Specific command to HRT-710 ?

A11: (2013/12/06)

[Case Example]

A user wants to get the HART command No.149 data from Emerson 8800D HART device.

[Solution]

< Software >

1. Users must get the HART Device-Specific command first. The HART command No.149 format of Emerson 8800D is like Figure 11-1.

Item	Value
Module name	Module 0
Channel	0
Configuration	Enable
Work	Point to Point Mode
Default Command (0)	Initial mode
Default Command (3)	Polling mode

Figure 11-1 The HART command No.149 format of Emerson 8800D

2. Add the HART command No.149 to HRT-710 like Figure 11-2.

Item	Value
Module name	Module 0
Channel	0
Configuration	Enable
Work	Point to Point Mode
Default Command (0)	Initial mode
Default Command (3)	Polling mode

Figure 11-2 Add the HART command No.149 to HRT-710

3. After the setting is finished, in the “Device Configuration” screen, please click the “Save to Device” button to save the parameters to HRT-710.

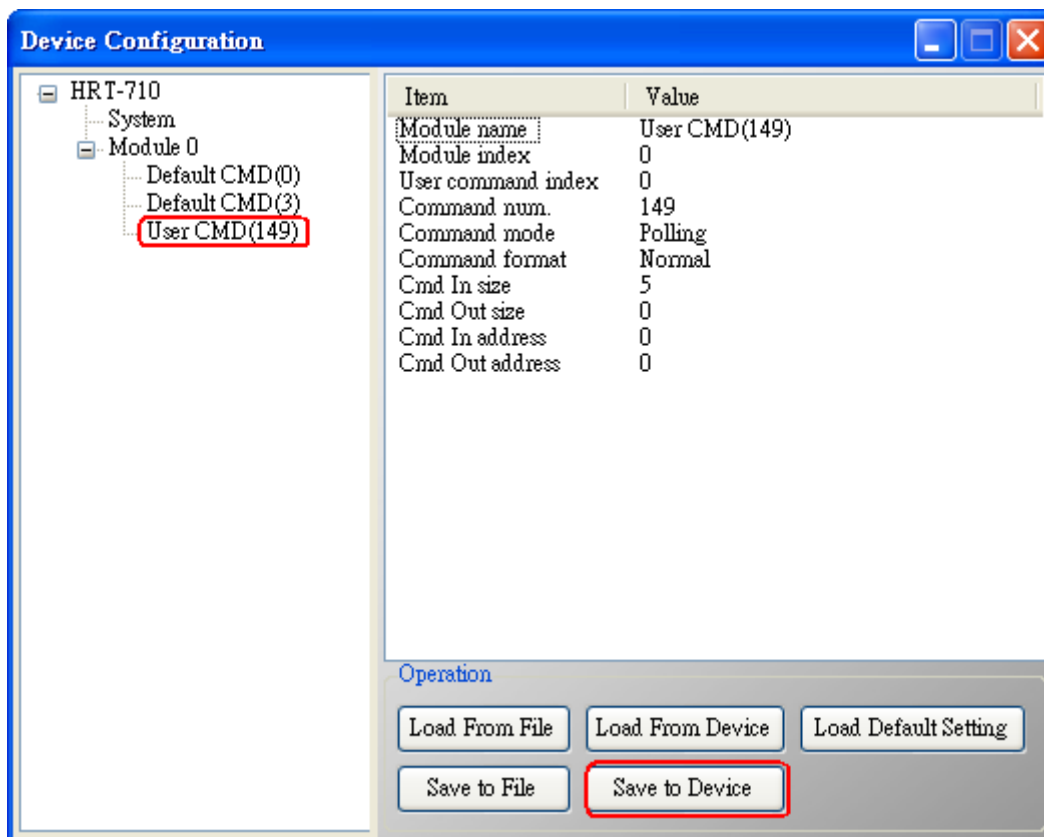

Figure 11-3 Save the parameters to HRT-710

4. Get the Modbus address for the HART command No.149 data.

(1) Open the “Address Map” screen and click the “UserCMD(149)” item.

[1] In the “Modbus AO” area, the light blue grid means the Modbus address for data sending.

[2] In the “Modbus AI” area, the light blue grid means the Modbus address for data receiving.

=> In the case, the HART command No.149 is used for reading data. Therefore, the light blue grid just show in “Modbus AI” area and the Modbus address for receiving data is from 0 to 2.

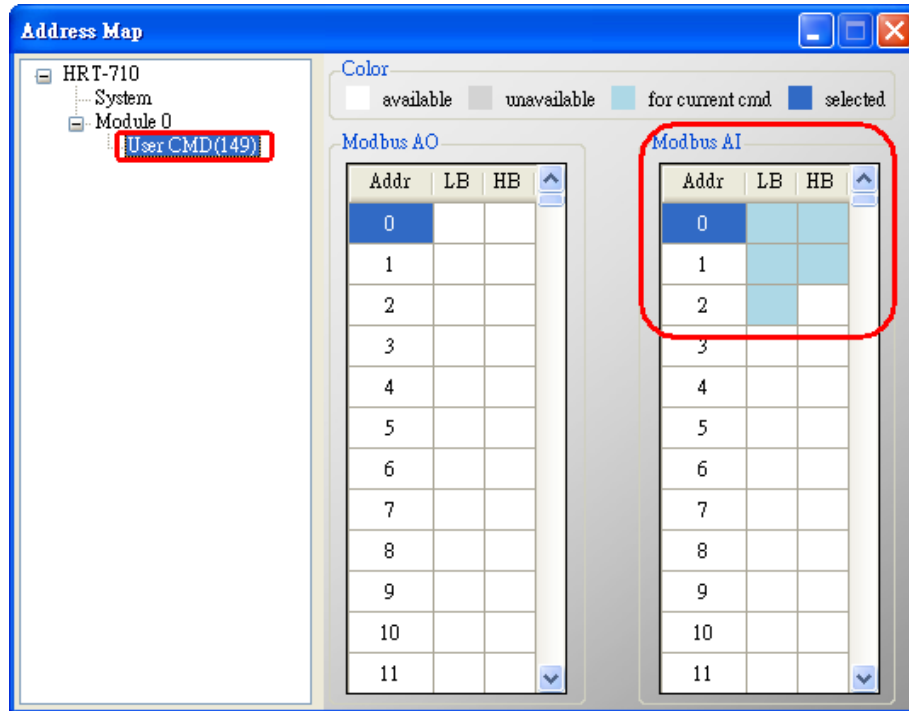

Figure 11-4 The Modbus address for UserCMD

- (2) Users can use the Modbus Function Code 4 and address from 0 to 2 to get the HART command No.149 data.
 (Ex: Request Cmd => 0x01 0x04 0x00 0x00 0x00 0x03)

Q12 : How to set HART device address by HRT-710 utility ?

A12: (2014/03/05)

[Please just connect one HART device in HART network every time.]

1. Add the “UserCMD(6)” to HRT-710 :
 - (1) Run “HG_Tool” and connect to HRT-710.
 - (2) Open the “Device Configuration” page.
 - (3) Add “UserCMD(6)” and choose “Manual” option in “Mode” field. (Figure 12-1)
 - (4) Click “Save to Device” button. (Figure 12-2)

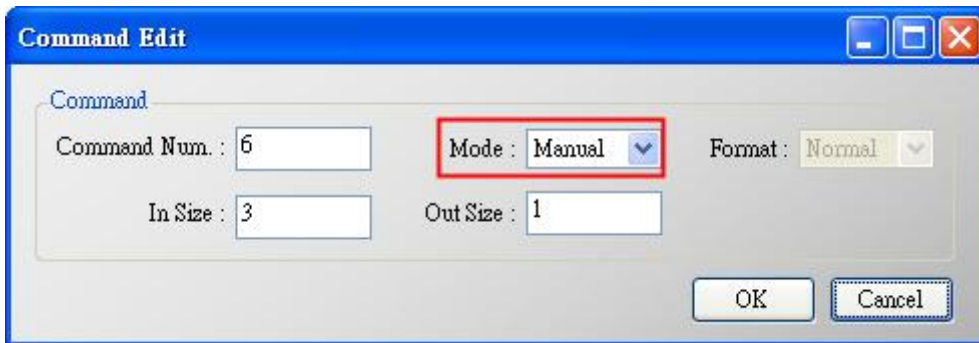

Figure 12-1 Add UserCMD(6)

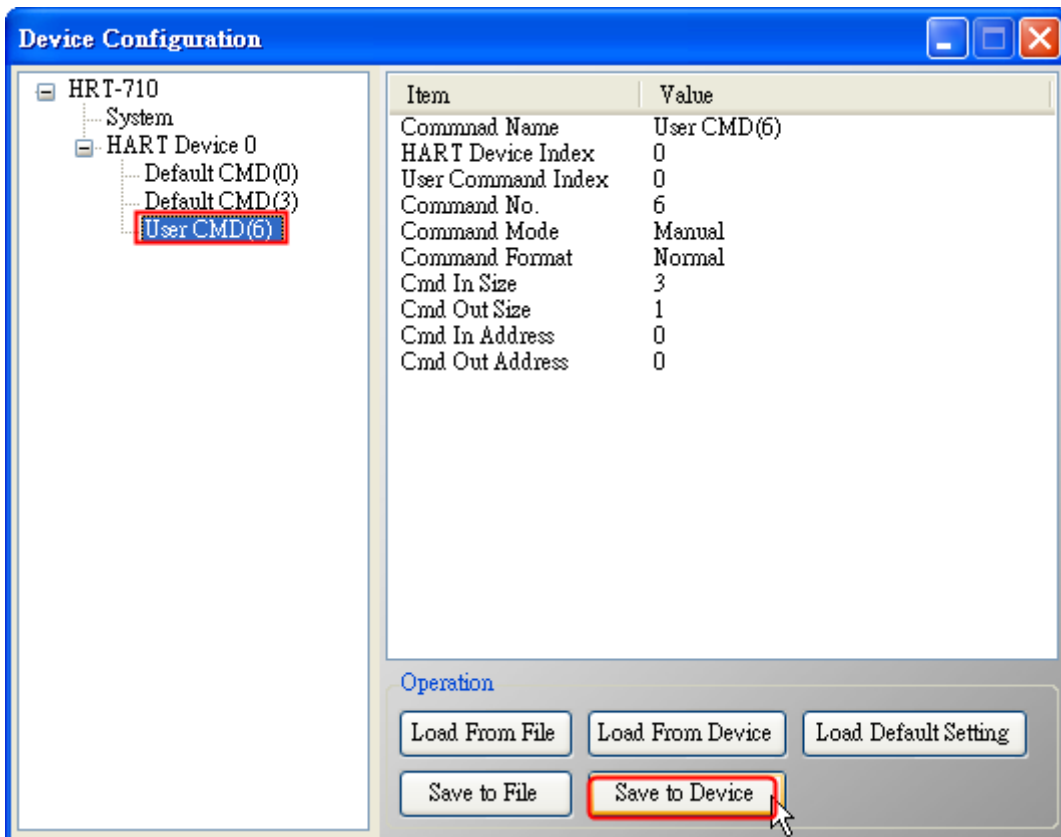

Figure 12-2 “Save to Device”

2. Set HART device address and send the UserCMD(6) :

- (1) Open "Device Information" page.
- (2) Right click on the "UserCMD(6)" item and choose the "Basic Operation".
(Figure 12-3, in the demo, the command index is 0 for the UserCMD(6).)
- (3) Input the HART device address value and click the "Send" button.
(Figure12-4, in the demo, HART device address will be set to be 2. Now the setting value is just saved in HRT-710 not sent out yet.)

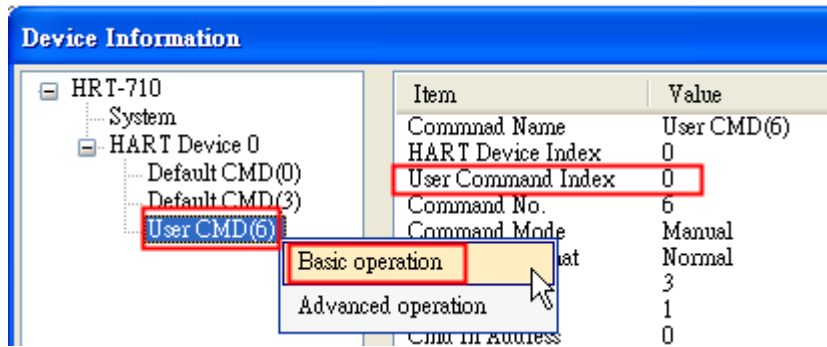

Figure 12-3 The "Basic Operation" of UserCMD(6)

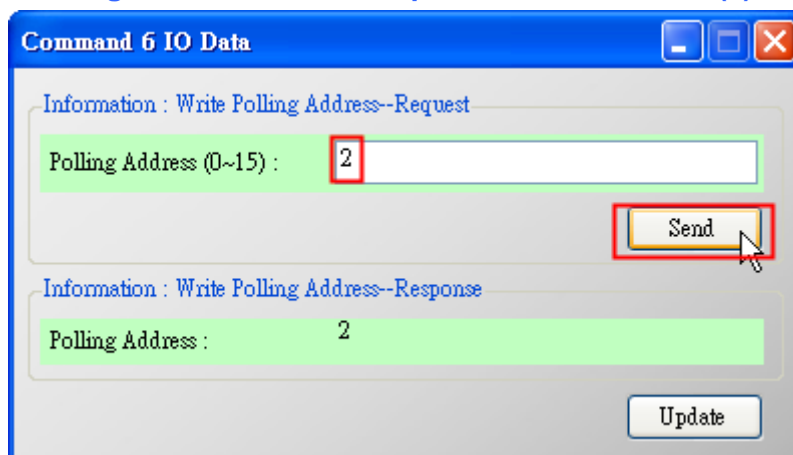

Figure 12-4 The "I/O Data" screen of UserCMD(6)

- (4) Right click on the "System" item and choose the "Basic Operation".
- (5) After finish the below settings, click "Send Data" button to send the UserCMD(6) to HART device. (Figure 12-6)
 - [1] "Auto Polling" field => "Disable"
 - [2] "Manual Trigger" field => "Enable"
 - [3] "Trigger Index of User Command" field => Input "0" (UserCMD(6) Index)

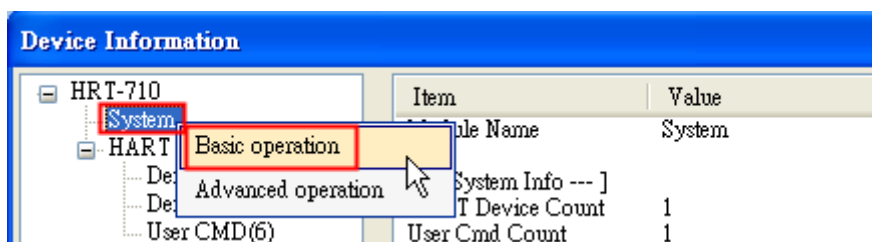

Figure 12-5 The “Basic Operation” of System

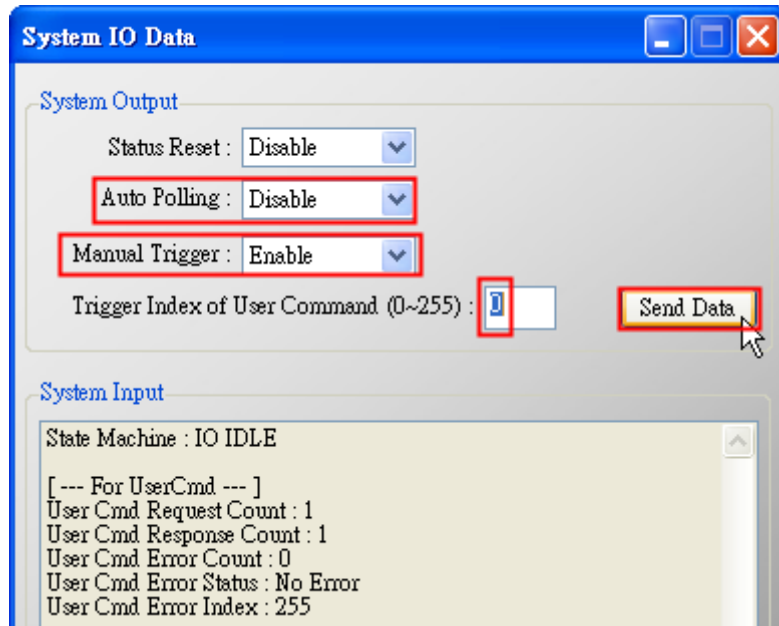

Figure 12-6 The “I/O Data” screen of System

3. Now the HART device address should be set to be 2. Then please reboot HRT-710.

Q13 : All kinds of HART network wiring ?

A13: (2015/10/26)

[1] The wiring of "Point to Point" :

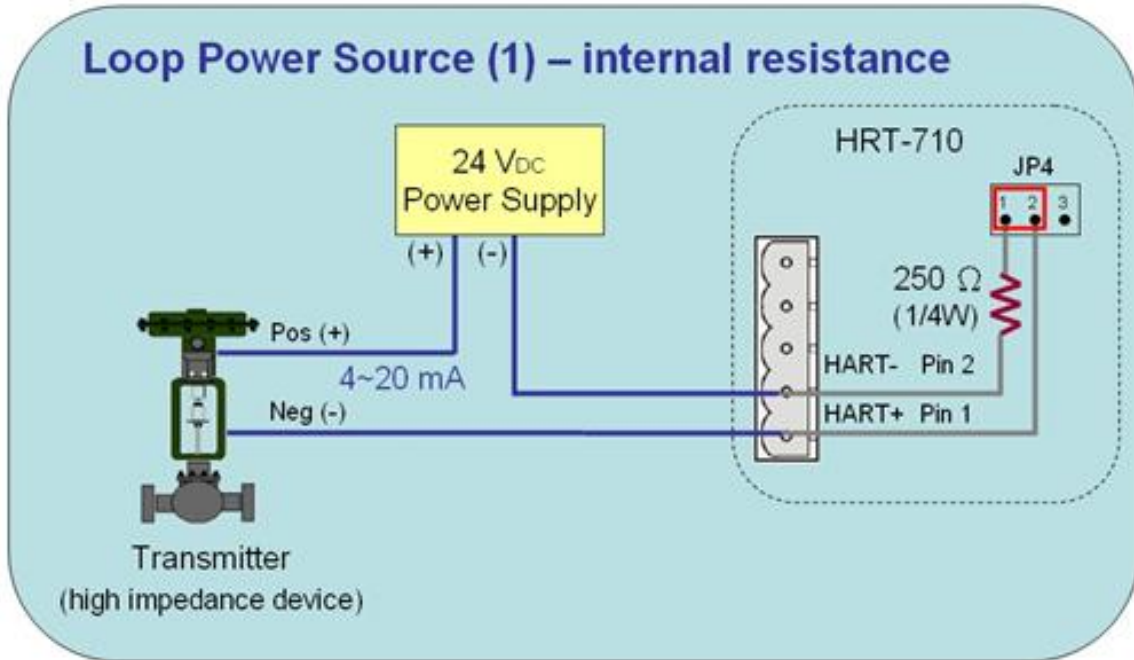

Figure 13-1 HART_P2P_Network_Passive (Built-In-Resistor)

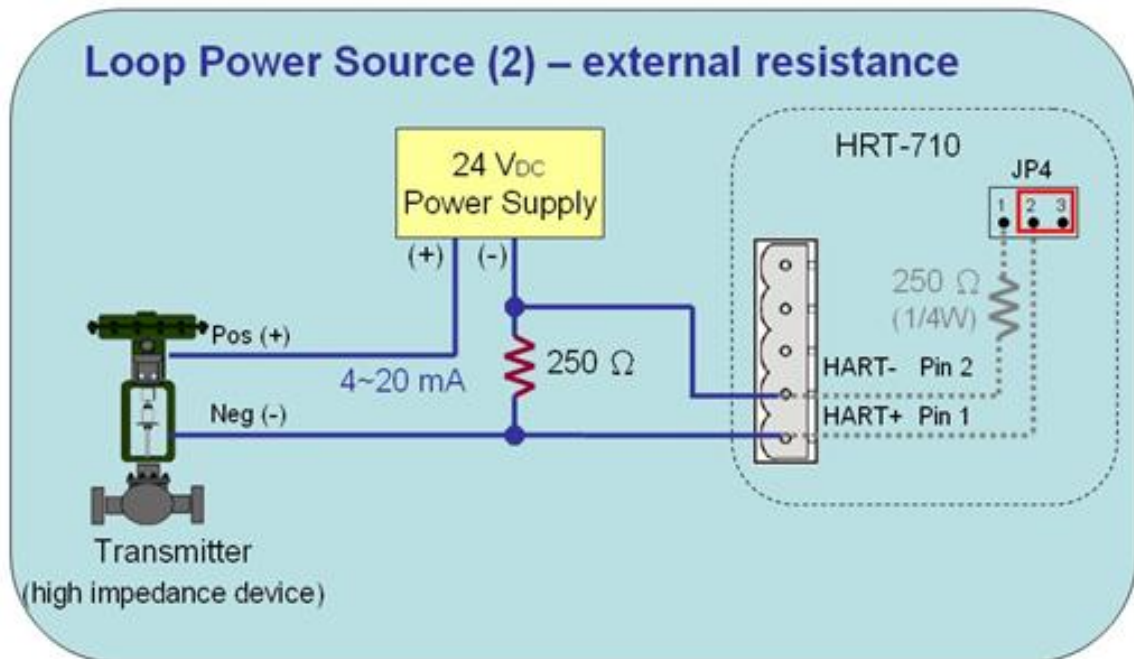

Figure 13-2 HART_P2P_Network_Passive (External-Resistor)

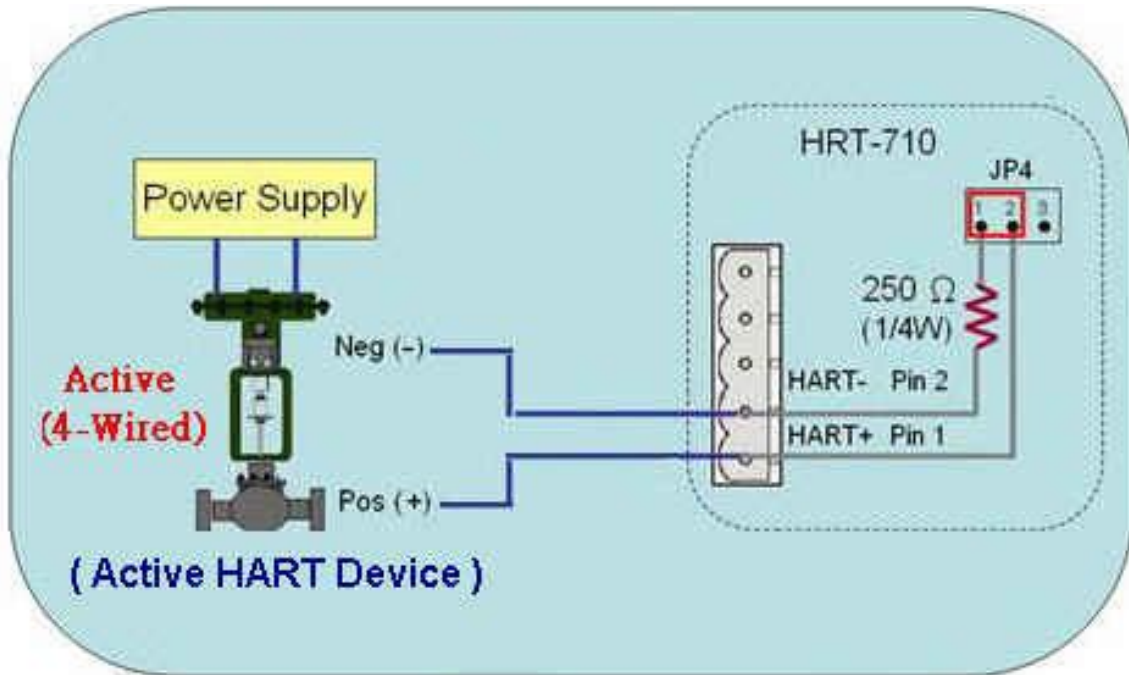

Figure 13-3 HART_P2P_Network_Active (Built-In-Resistor)

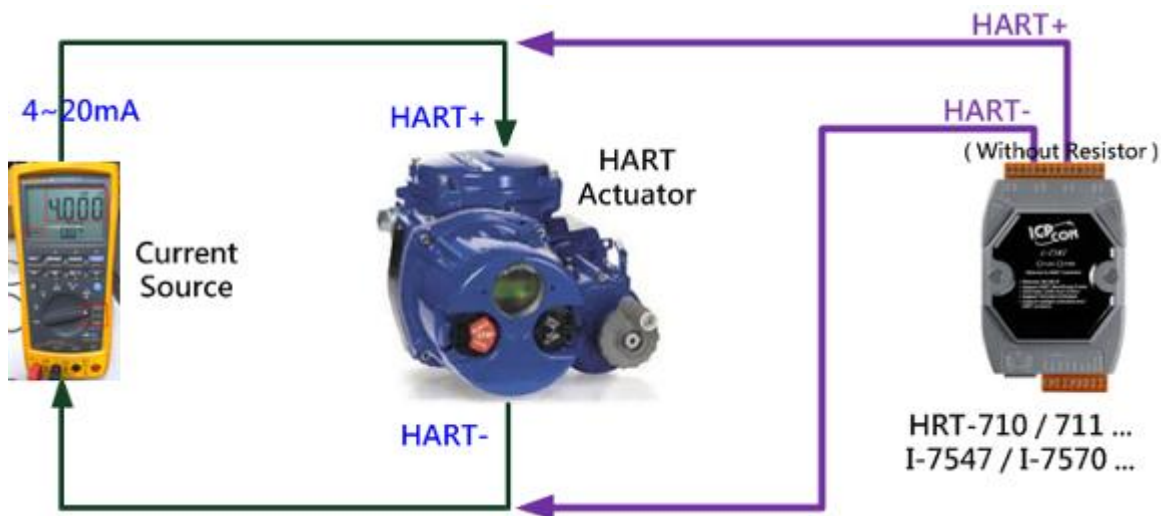

Fig 13-3-1 : "P2P" mode (HART Actuator, Without Resistor)

[2] The wiring of “Multi-Drop”:

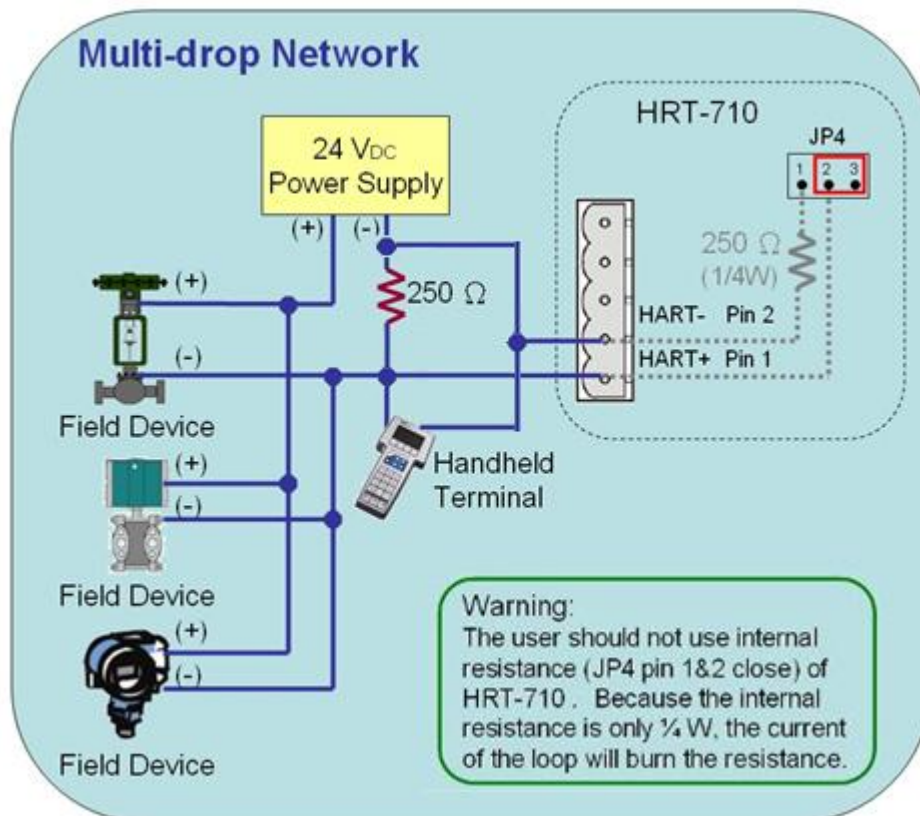

Figure 13-4 HART_Multi-Drop_Network_Passive

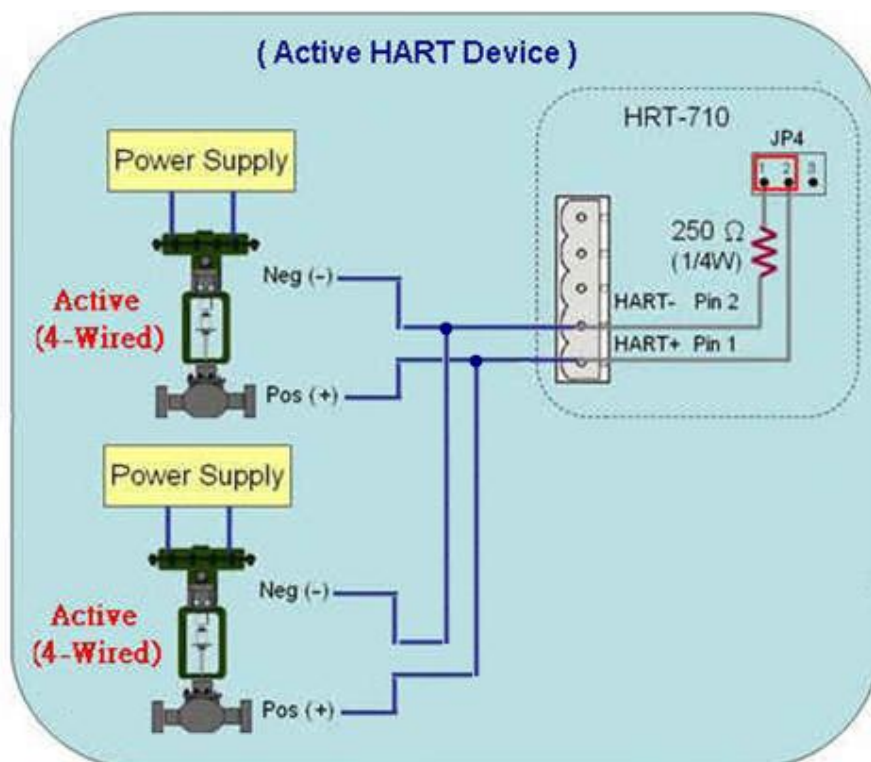

Figure 13-5 HART_Multi-Drop_Network_Active

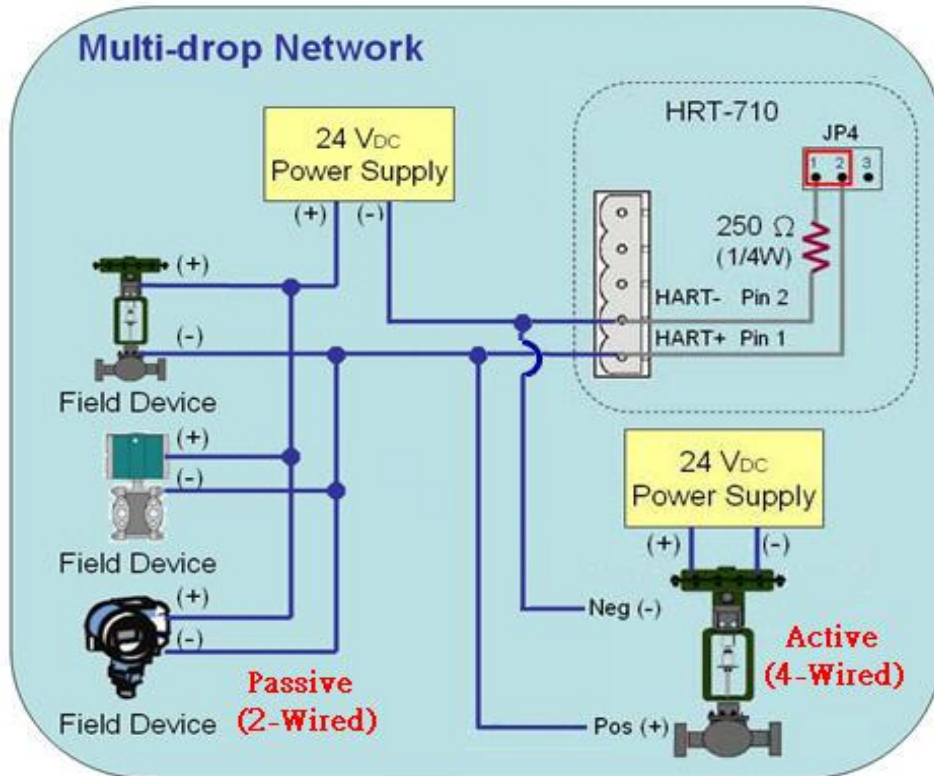
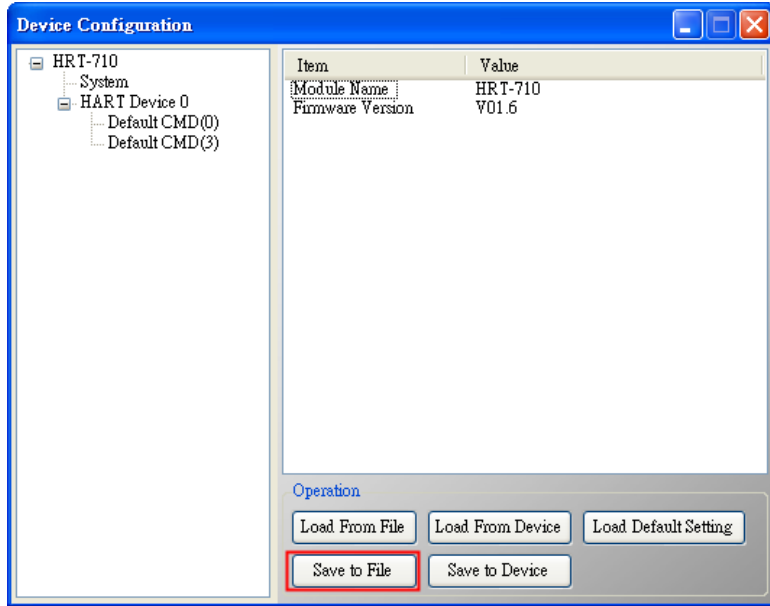

Figure 13-6 HART_Multi-Drop_Network_Active & Passive

Q14 : Apply the same settings to the other HRT-710 rapidly ?

A13: (2015/12/21)

- 1. Save HRT-710 settings to file.
 - (1) Run the HRT-710 utility, HG_Tool.
 - (2) In the “Device Configuration” page, click the “Save to File” button to save the current settings of HRT-710 to file.



- 2. Load the settings from HRT-710 file to the other HRT-710 module.
 - (1) In the “Device Configuration”, click the “Load From File” button and choose the setting file of HRT-710. Then it will show all the settings in the HG_Tool.

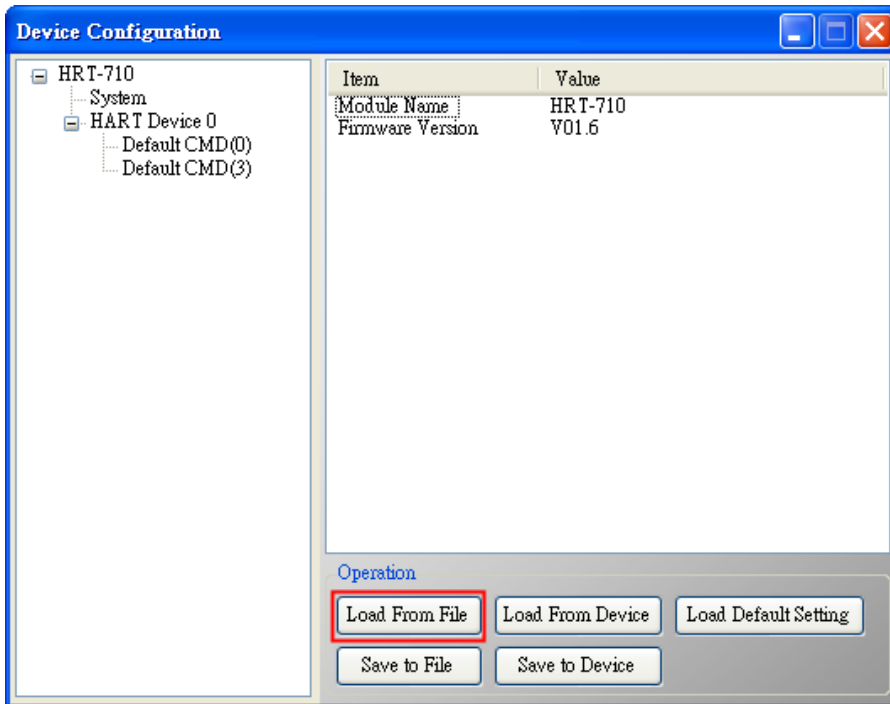

(2) Click the “Save to Device” button to set the settings to HRT-710 module.

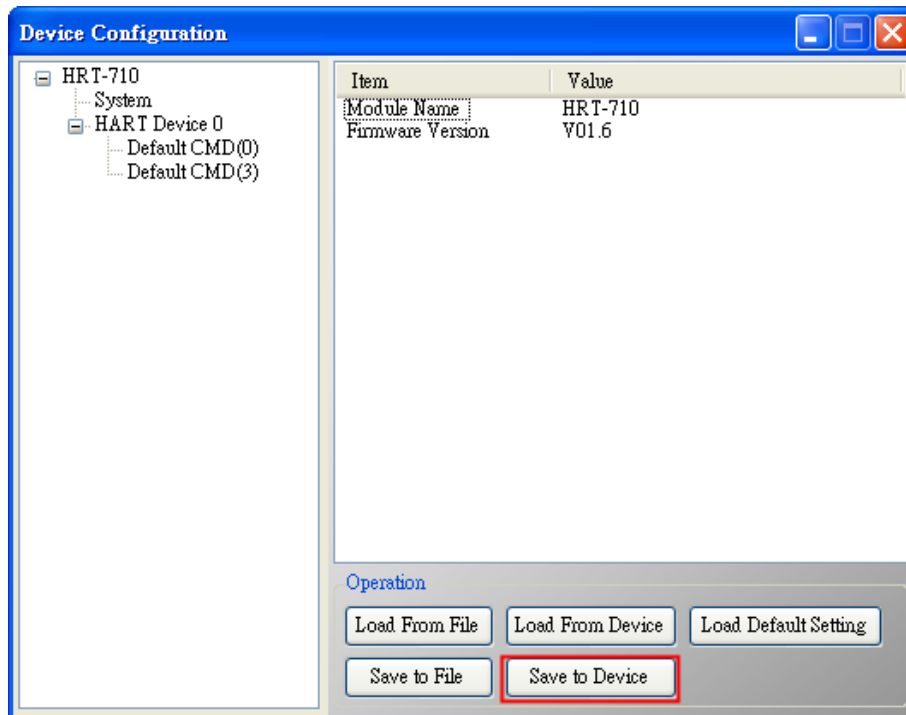

Q15 : How to send HART command for writing ? (Ex: CMD19)

A13: (2015/12/23)

1. Add the HART command for writing in HRT-710.

(The HART cmd 19 is used in the below example => Final Assembly Number)

(1) In the “Device Configuration” page, click the right button of mouse on the “HART Device 0” item and choose the “Add Command” option.

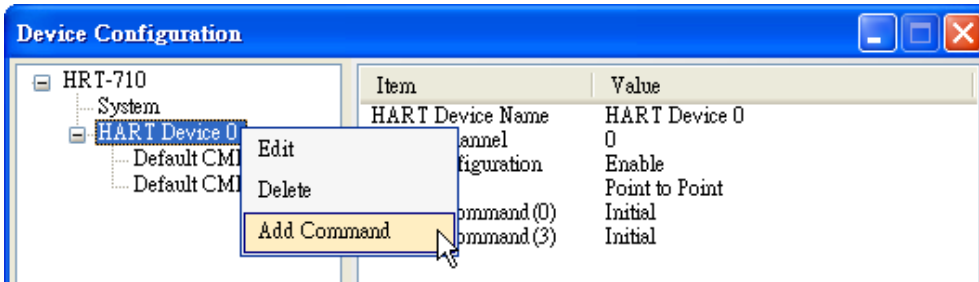

(2) Input the value “19” in the “Command Num” field and choose the “Manual” option in the “Mode” field. Click the “OK” button to add the HART command 19 (Now the User Command Index is 0) and click the “Save to Device” button to save the current settings to HRT-710.

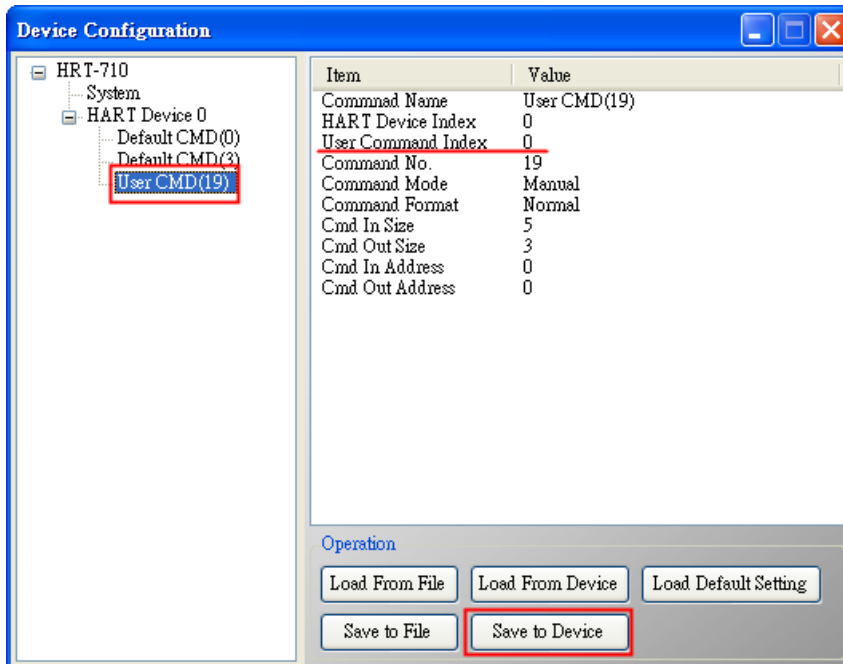
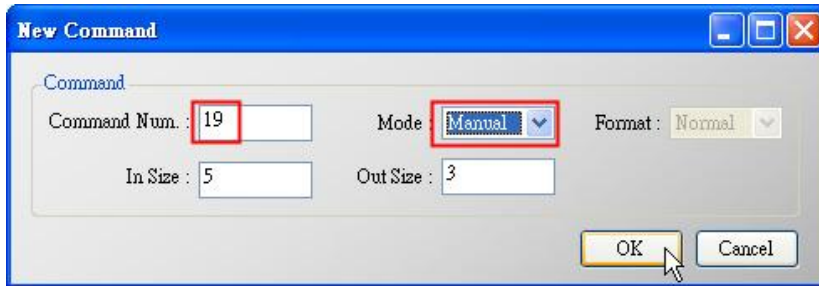

2. Set the value for the HART writing command. (HART command not yet sent)
 - (1) There are three bytes parameters for HART command 19.
 - (2) For example, the value for these three bytes parameters is 11(0x0B), 22(0x16), 33(0x21) for writing, and the Modbus command will be as below.
 => 01 **06** 00 00 **0B 16** 0F 34
 => 01 **06** 00 01 **21 00** C0 5A
 - (3) The below figure is the assigned value for writing in HART command 19 by using ModScan software for testing.

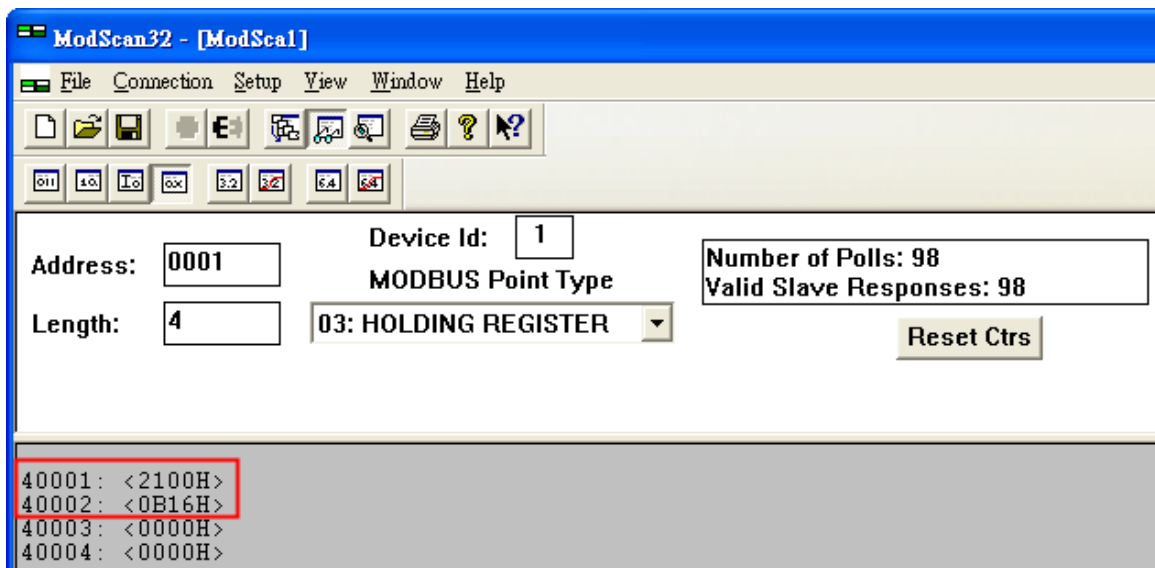

- (4) After sending the above Modbus command, users can check if these values have been set successfully via HG_Tool.
 - [1] In the “Device Information” page, click the right button of mouse on the “User CMD(19)” item and choose the “Advanced operation” option.

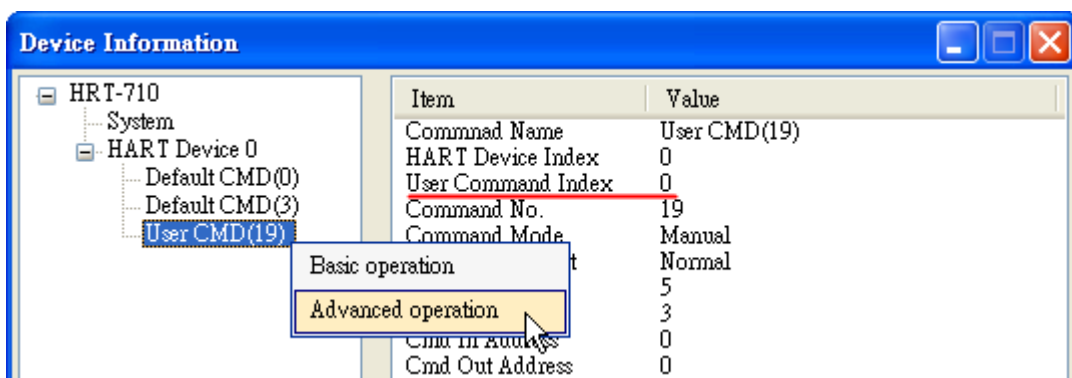

- [2] In the “I/O Data” page, click the “Update” button and it will show the value for sending of UserCMD in the corresponding byte address in the “Output Data” area. Users can see these values of “11”, “22” and “33” been set successfully.

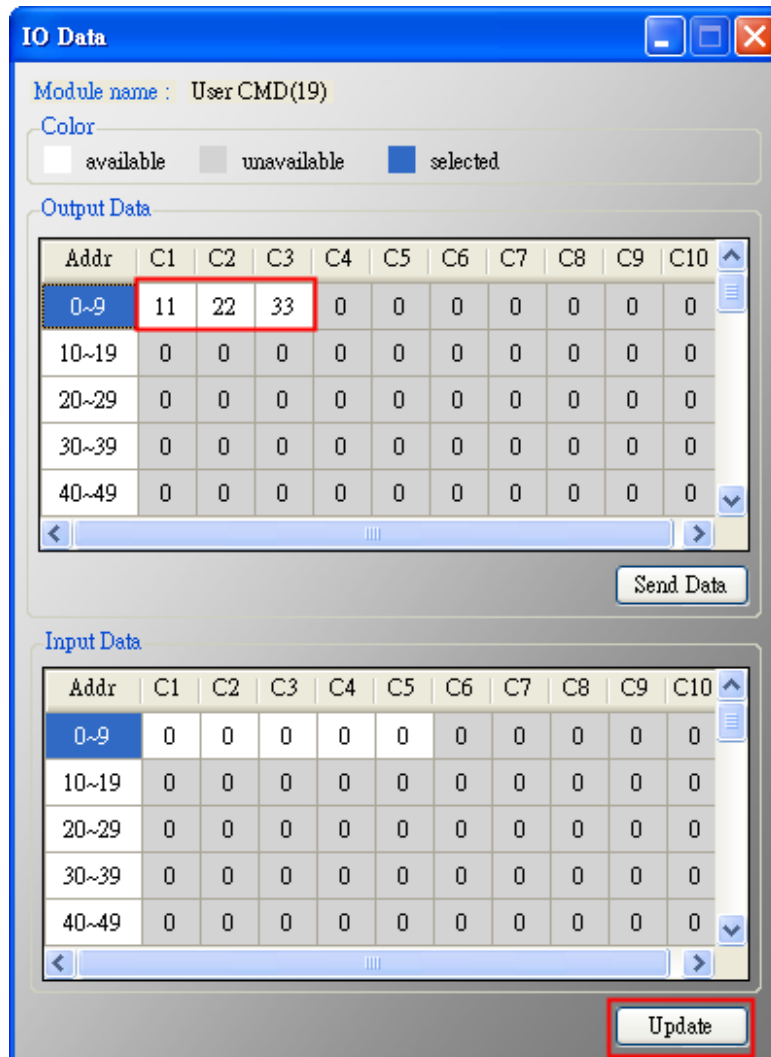

3. Trig the HRT-710 to send the UserCMD0 (HART command 19).

(1) Stop the original HART polling command and send the UserCMD0.

The Modbus command will be as below.

=> 01 06 **01 F5 00 00 98 04**

=> 01 06 **01 F6 01 00 69 94**

[1] **00** : Stop all the original HART polling command.

[2] **00** : Set the no. of UserCMD for sending.

[3] **01** : Trig to send the UserCMD and it needs the different value every time.

(Ex: the next value will be 2, 3, 4 ...)

=> Now the UserCMD0 (HART command 19) has been sent.

(2) Recover the original HART polling command.

The Modbus command will be as below.

=> 01 06 **01 F5 01 00 99 94**

[1] **01** : recover all the original HART polling command.

Q16 : Integrate GT-540/ GT-541M to get HART device data via 3G/ 4G?

A16: (2018/07/03)

[Application Structure]

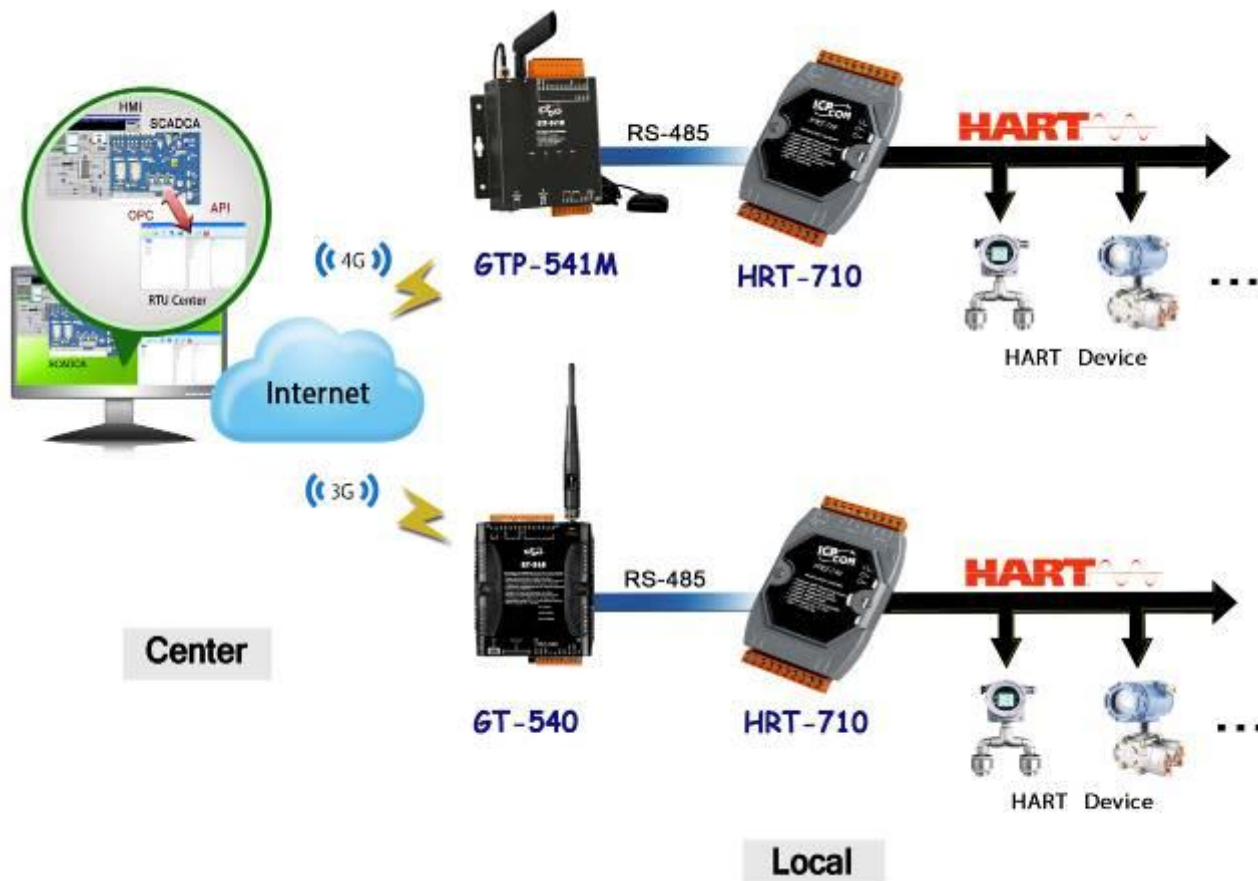

[HART Device Simulation]

(1) The below adopts HDS (HART Device Simulator) to simulator two HART devices.

(About HDS :

http://www.icpdas.com/root/product/solutions/industrial_communication/fieldbus/hart/convertor/hds.html)

(2) The simulation value of HART Device 1 and 2 are as below table.

Enable	Short Addr	Long Addr (HEX)	PV_Value	PV_Unit	SV_Value	SV_Unit	TV_Value	TV_Unit	QV_Value	QV_Unit
<input type="checkbox"/>	00	0x16850B0A42	0.111111	psi	0.222222	bar	0.333333	mbar	0.444444	g/cm2
<input checked="" type="checkbox"/>	01	0x0A01000000	11.111111	kg/cm2	11.222222	Pa	11.333333	kPa	11.444444	torr
<input checked="" type="checkbox"/>	02	0x0D14000000	22.111111	MPa	22.222222	gal/sec	22.333333	gal/min	22.444444	gal/hr
<input type="checkbox"/>	03	0x1190000000	33.111111	l/sec	33.222222	l/min	33.333333	l/hr	33.444444	m3/sec

	Current	PV	SV	TV	QV
HART Dev1	4.00	11.11111	11.22222	11.33333	11.44444
HART Dev2	4.00	22.11111	22.22222	22.33333	22.44444

[Steps]

GT-540 is used here as 3G network example, 4G network settings are identical for GT-541M.

1. Connect the RS-485 between GT-540 and HRT-710.

(The Modbus/RTU communication of GT-540 just supports RS-485 interface.)

2. Connect the RS-232 between PC and GT-540.

3. Run the GT-540 utility to configure the below settings.

(1) Main Info -> RTU Mode -> Machine ID => 1 (adjustable) ◦

Main Info -> RTU Mode -> Data Update Period (sec) => 2 (adjustable) ◦

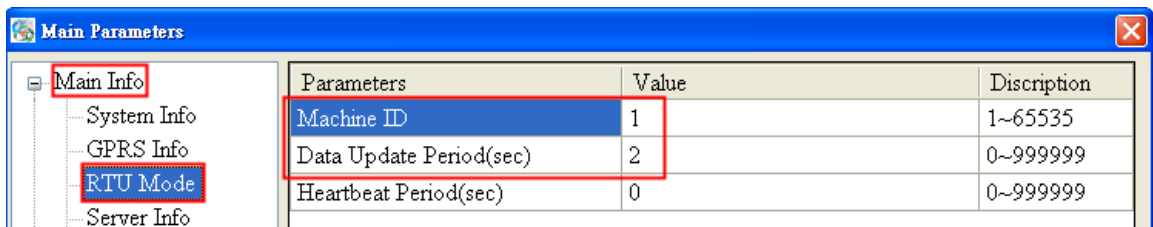

(2) Main Info -> Server Info -> Server IP => The fixed IP address of PC that running RTU_Center software.

Main Info -> Server Info -> Server Port => 10000. (default)

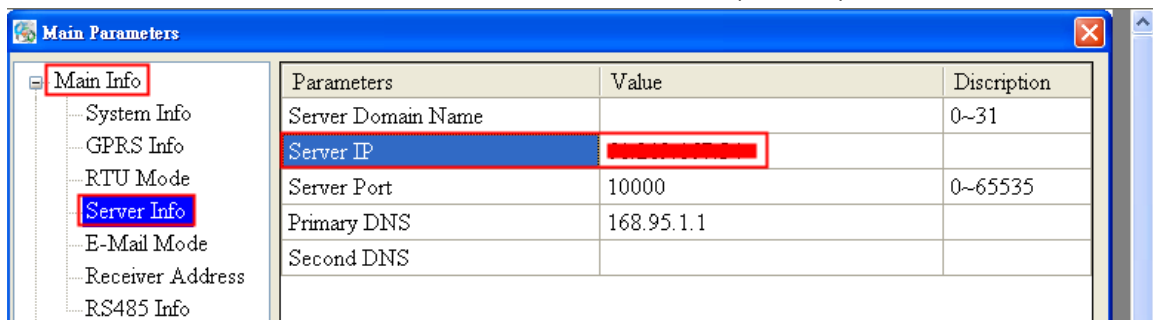

(3) Main Info -> RS485 Info => The same serial port comm. settings of HRT-710.

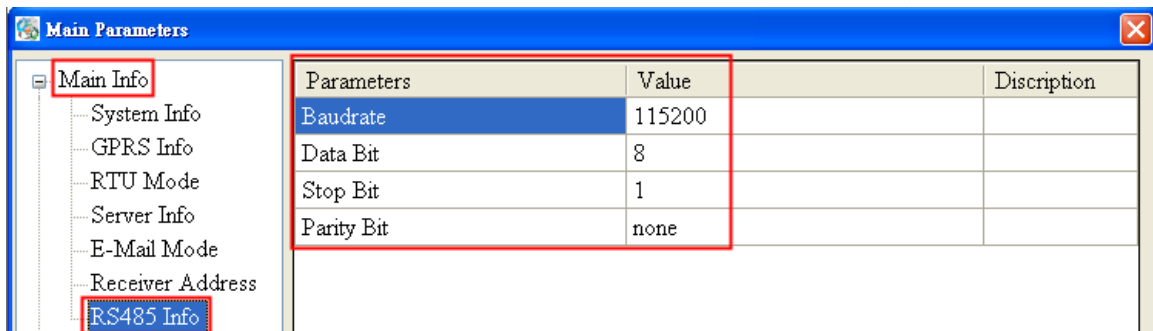

(4) Modbus Device => Add the Modbus address of HART device data.

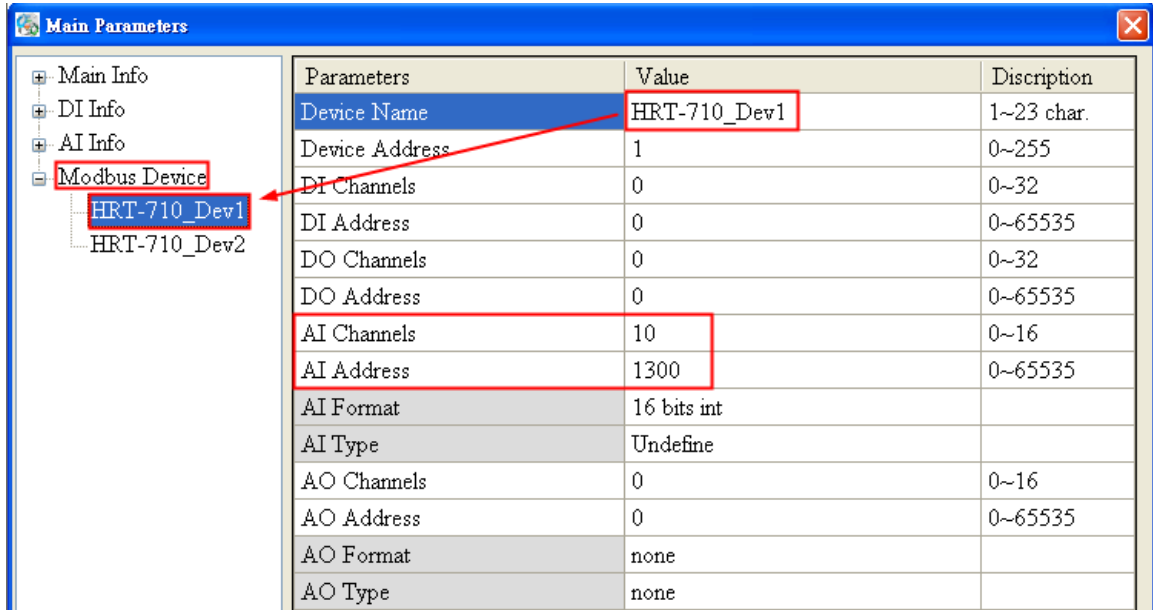

(5) If using multi HART devices, then add the next Modbus address table in sequence.

(Note : AI Address =>It needs to add 10 in the second HART device and it will be 1310 and the third will be 1320 and so on.

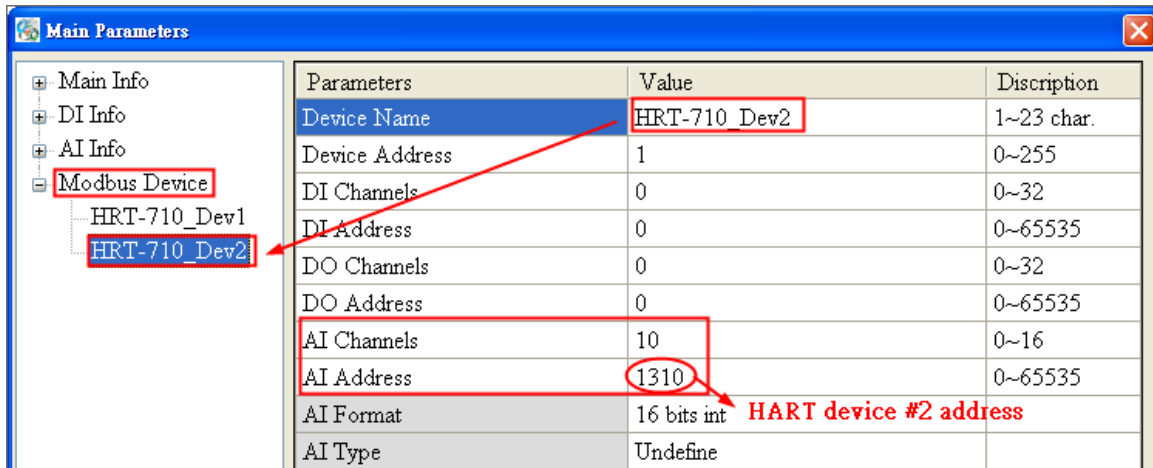

(6) After finish, click the “Write to Device” button to save settings to GT-540.

4. Run the “M2M RTU Center” software in the data center server.

(1) Create a new 3G connection device for the GT-540.

[1] Module : choose the “GT-540” option.

[2] Station ID : Set to be “1” (The same with Machine ID in GT-540 utility)

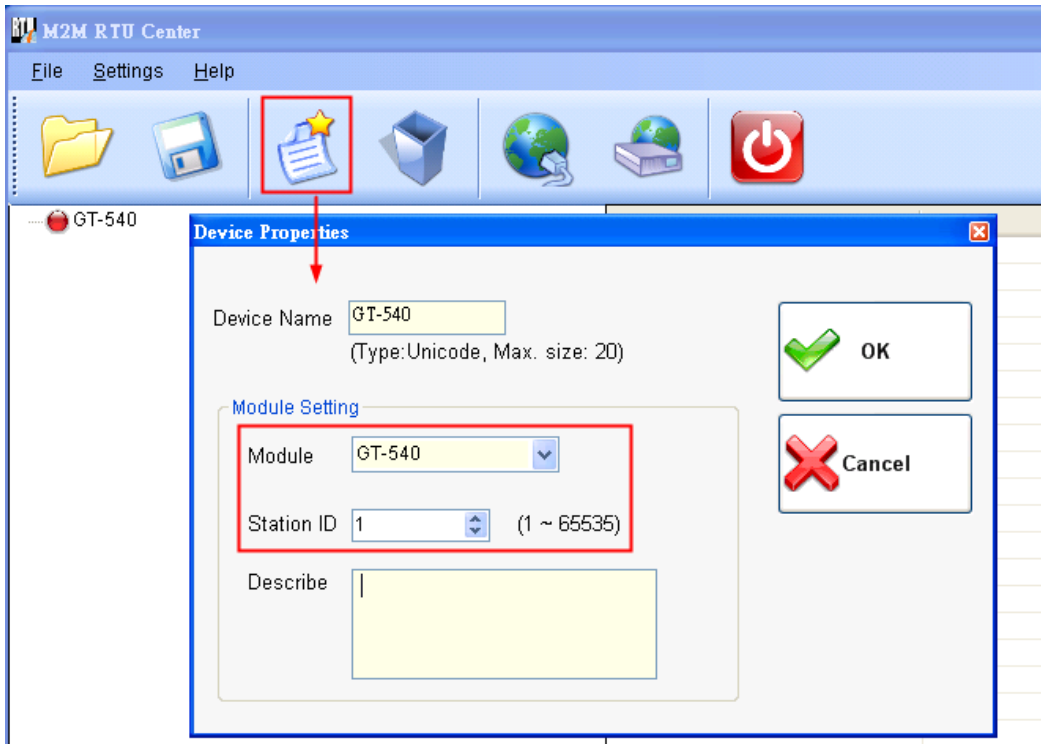

(2) After GT-540 connects to RTU_Center software successfully, click the “GT-540 -> HRT-710_Dev1” item in RTU_Center and it will show the HART device 1 data in the AI0~AI9 fields as below.

- [1] Current : AI0 and AI1 (DWORD: 0x40800000 -> Float: 4.00000)
- [2] PV : AI2 and AI3 (DWORD: 0x4131C717 -> Float: 11.11111)
- [3] SV : AI4 and AI5 (DWORD: 0x41338E39 -> Float: 11.22222)
- [4] TV : AI6 and AI7 (DWORD: 0x41355555 -> Float: 11.33333)
- [5] QV : AI8 and AI9 (DWORD: 0x41371C71 -> Float: 11.44444)

Parameter	Status
Modbus Module Name	HRT-710_Dev1
Modbus Slave ID	1
Date&Time	2016/02/18 10:02:12
DI Count	0
DO Count	0
AI Count	10
AO Count	0
Counts	0
Data Valid	1
AI0	0h
AI1	4080h
AI2	C71Ch
AI3	4131h
AI4	8E39h
AI5	4133h
AI6	5555h
AI7	4135h
AI8	1C71h
AI9	4137h

(3) Click the “GT-540 -> HRT-710_Dev2” item in RTU_Center and it will show the HART device 2 data in the AI0~AI9 fields as below.

- [1] Current : AI0 and AI1 (DWORD: 0x40800000 -> Float: 4.00000)
- [2] PV : AI2 and AI3 (DWORD: 0x41B0E38E -> Float: 22.11111)
- [3] SV : AI4 and AI5 (DWORD: 0x41B1C71C -> Float: 22.22222)
- [4] TV : AI6 and AI7 (DWORD: 0x41B2AAAA -> Float: 22.33333)
- [5] QV : AI8 and AI9 (DWORD: 0x41B38E39 -> Float: 22.44444)

Parameter	Status
Modbus Module Name	HRT-710_Dev2
Modbus Slave ID	1
Date&Time	2016/02/18 10:02:47
DI Count	0
DO Count	0
AI Count	10
AO Count	0
Counts	0
Data Valid	1
AI0	0h
AI1	4080h
AI2	E38Eh
AI3	41B0h
AI4	C71Ch
AI5	41B1h
AI6	AAAAh
AI7	41B2h
AI8	8E39h
AI9	41B3h

5. In Server PC, show the HART device data in HIM or SCADA.

There are two methods to get the data from M2M RTU_Center software.

[Method 1] Using OPC Client : (“InduSoft OPC Client” Demo)

- [1] Run the OPC Server (M2M DA Server) .
- [2] Click the “Search” function, it will add all the data in RTU_Center to OPC server automatically and then click the “Monitor” button to show the real-time info.

Name	Device Type	Location	Channel Type	Channel	Value
Ch00	HRT-710_Dev1	1	Analog Input	0	0
Ch01	HRT-710_Dev1	1	Analog Input	1	16512
Ch02	HRT-710_Dev1	1	Analog Input	2	50972
Ch03	HRT-710_Dev1	1	Analog Input	3	16689
Ch04	HRT-710_Dev1	1	Analog Input	4	36409
Ch05	HRT-710_Dev1	1	Analog Input	5	16691
Ch06	HRT-710_Dev1	1	Analog Input	6	21845
Ch07	HRT-710_Dev1	1	Analog Input	7	16693
Ch08	HRT-710_Dev1	1	Analog Input	8	7281
Ch09	HRT-710_Dev1	1	Analog Input	9	16695

[3] In InduSoft, add the “OPC DA Client worksheet” and the OPC server data can be saved in InduSoft tag.

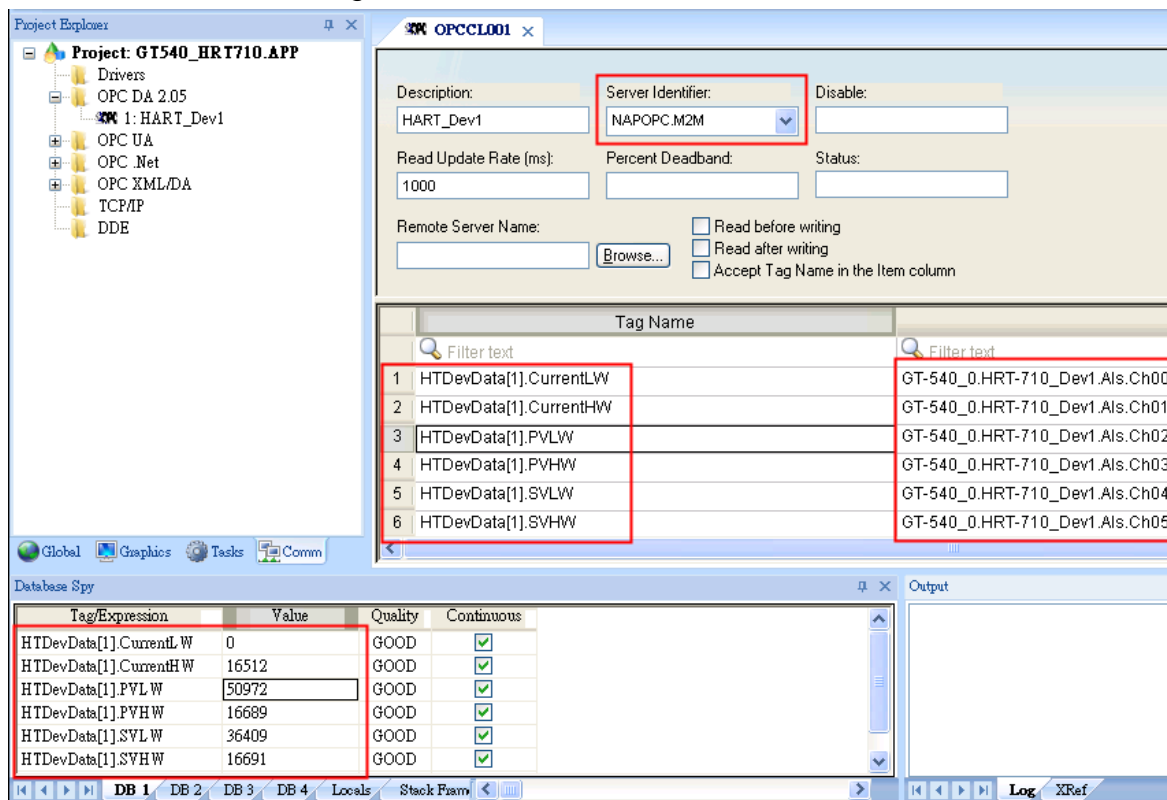

[Method 2] Using the API library of RTU_Center software.

[1] API Library Manual:

http://ftp.icpdas.com/pub/cd/usbcd/napdos/m2m/rtu/m2m_rtu_win32_api/manual/

[2] API Library Demo:

http://ftp.icpdas.com/pub/cd/usbcd/napdos/m2m/rtu/m2m_rtu_win32_api/software/demo/

Q17 : How to get HART command 48 information?

A17: (2016/10/07)

1. Add HART CMD 48 to HRT-710.

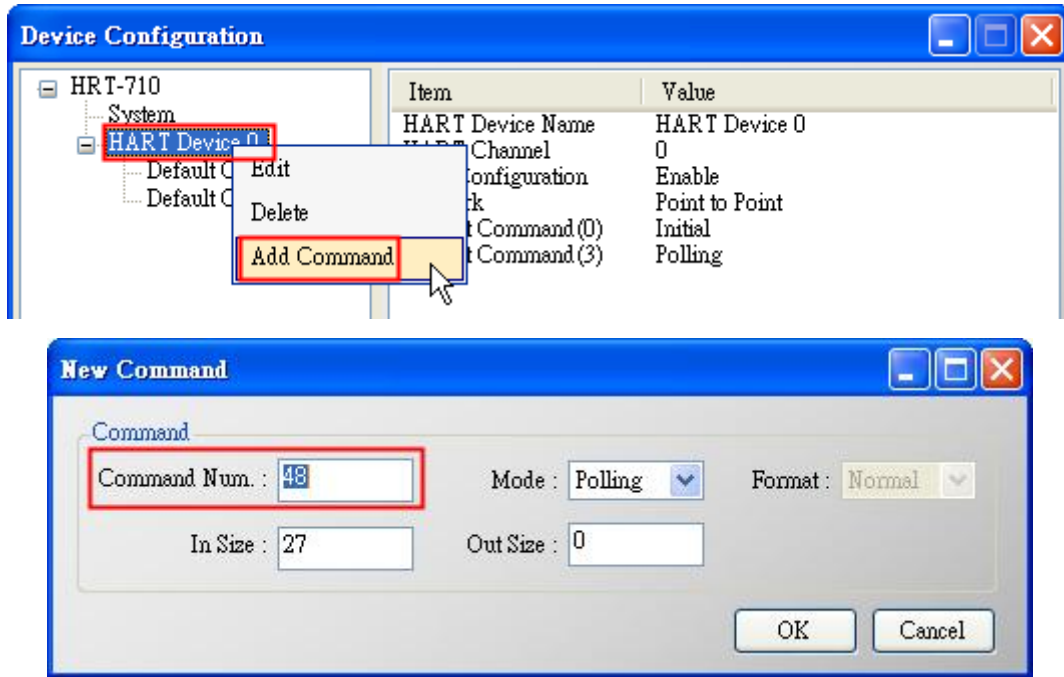

Figure 17-1 Add HART CMD 48 to HRT-710

2. In the “Device Configuration” screen, click the “Save to Device” button to save the settings to HRT-710.

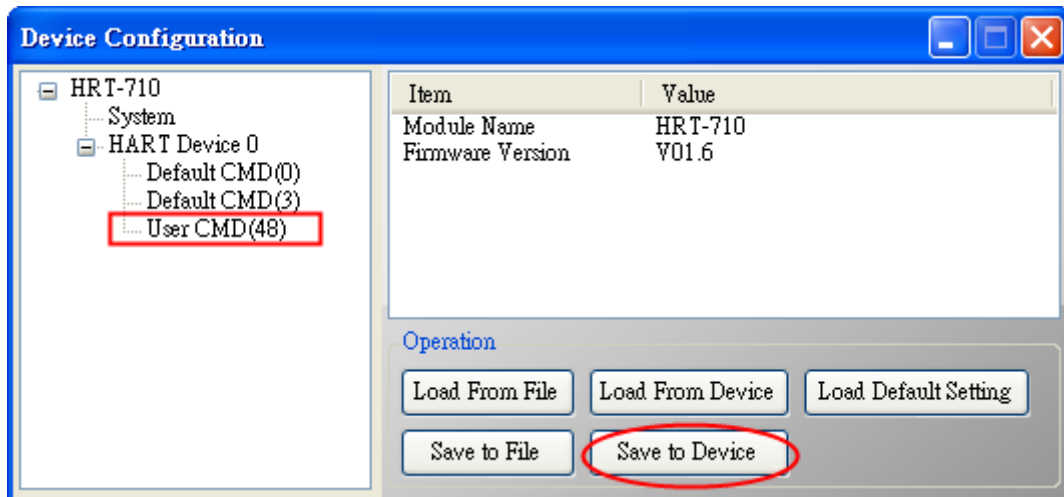

Figure 17-2 Save the settings to HRT-710

3. Get HART CMD48 data via Modbus.

(1) Open the “Address Map” screen and click the “UserCMD(48)” item. In the “Modbus AI” area, it will show the Modbus data address of UserCMD(48) with blue grid.

=> The response data length of HART CMD 48 will be 27Bytes (ResCode(2) and

ResData(25)). Therefore, it will occupy 14 WORD Modbus address as below address 0 ~ 13.

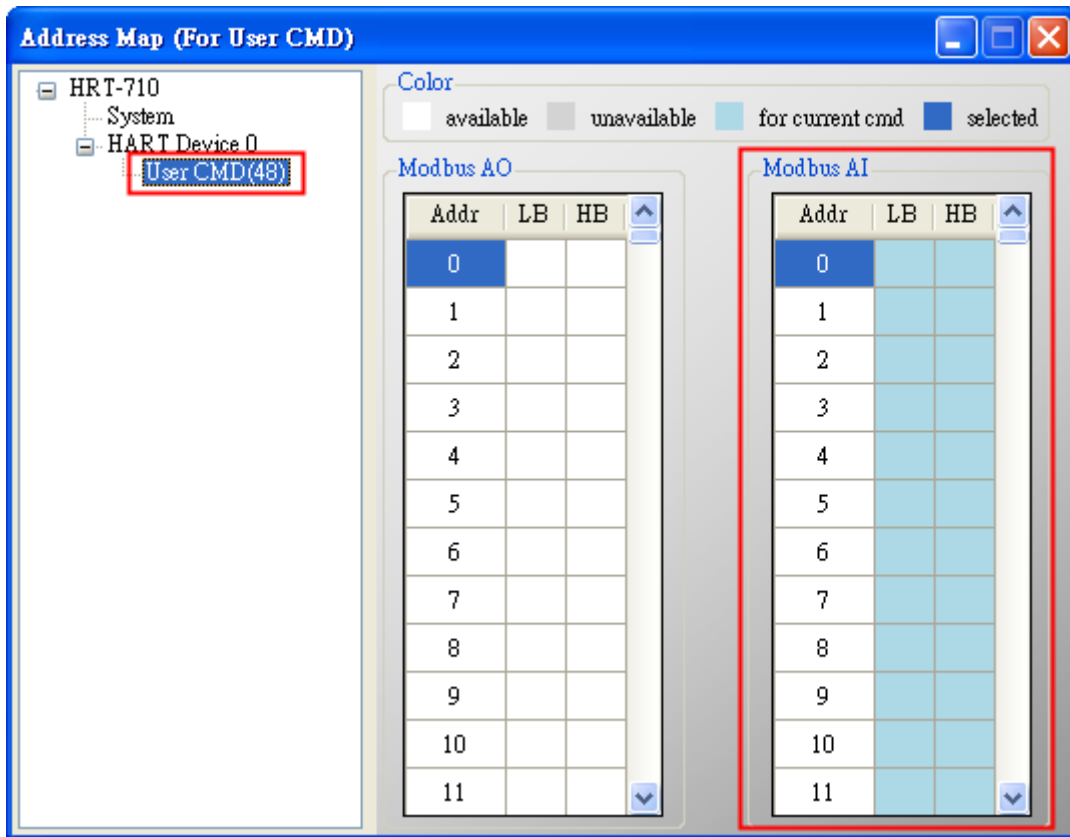

Figure 17-3 The modbus address occpied by UserCMD(48)

(2) Using Modbus Function Code 4 and address 0~13 to get the data of HART CMD 48.

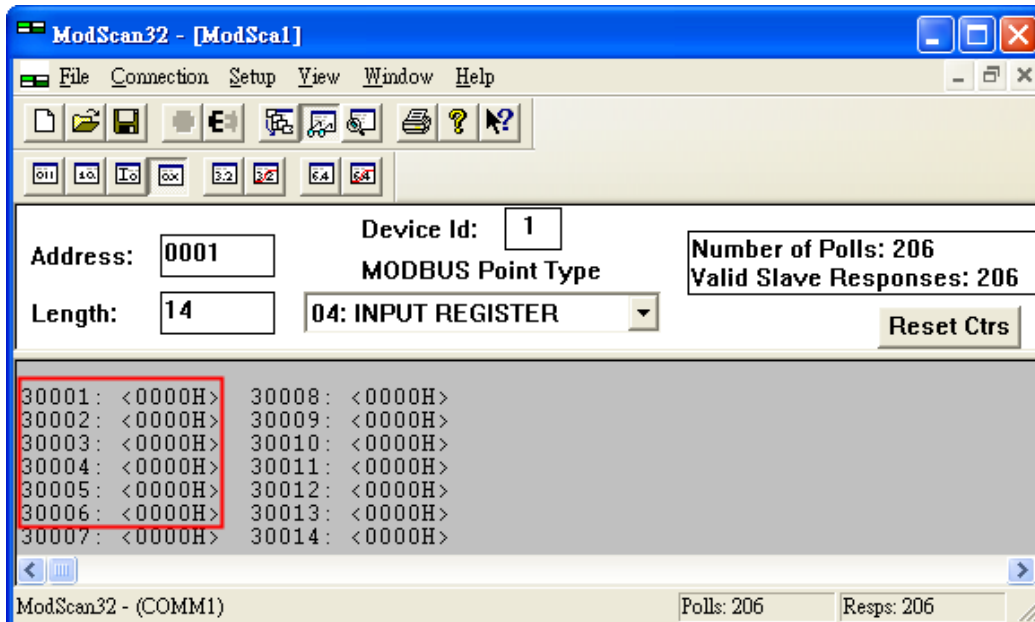

Figure 17-4 Get the HART CMD 48 data by using “ModScan”

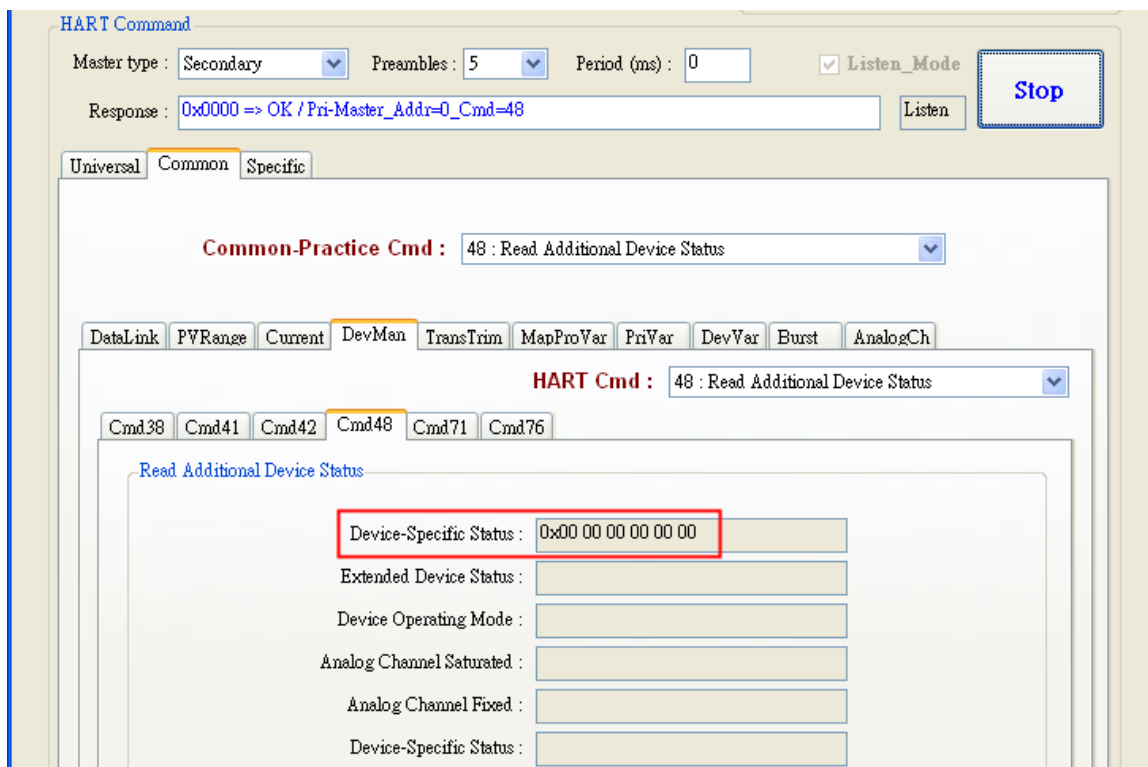

Figure 17-5 Get the HART CMD 48 data by using “HC_Tool (HART Master)”

Q18 : How to send HART “Burst Mode” CMD? (CMD108/109)

A18: (2017/01/09)

1. The below is the description for HART burst command function.

(1) HART CMD 108 (Write Burst Mode Command Number)

=>Used to set the response HART command no. when HART device burst mode is enabled.

(2) HART CMD 109 (Burst Mode Control)

=>Used to set HART device burst mode enabled or disabled.

2. Add HART CMD 108 and 109 to HRT-710

(1) In the “**Device Configuration**” page, click the right button of mouse on the “**HART Device 0**” item and choose the “**Add Command**” option.

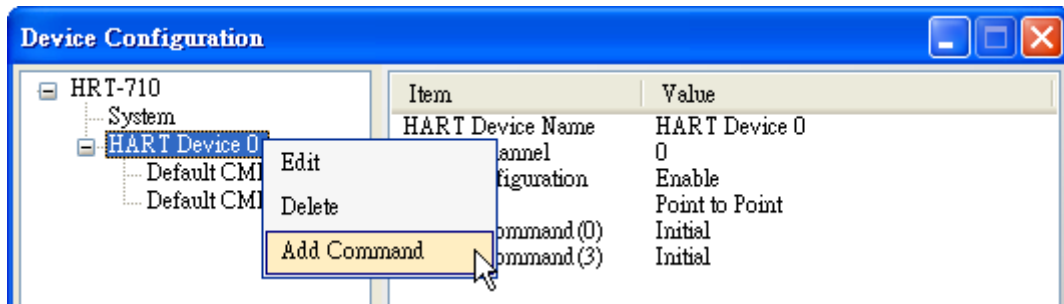

(2)[1] Input the value “**108**” in the “**Command Num**” field and choose the “**Manual**” option in the “**Mode**” field. Click the “**OK**” button to add the HART command 108 (Now the User Command Index is 0)

[2] Input the value “**109**” in the “**Command Num**” field and choose the “**Manual**” option in the “**Mode**” field. Click the “**OK**” button to add the HART command 109 (Now the User Command Index is 1)

[3] Click the “**Save to Device**” button to save the current settings to HRT-710.

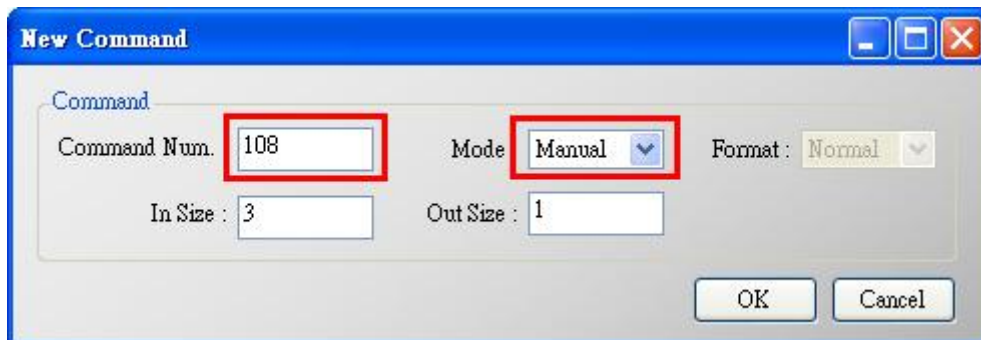

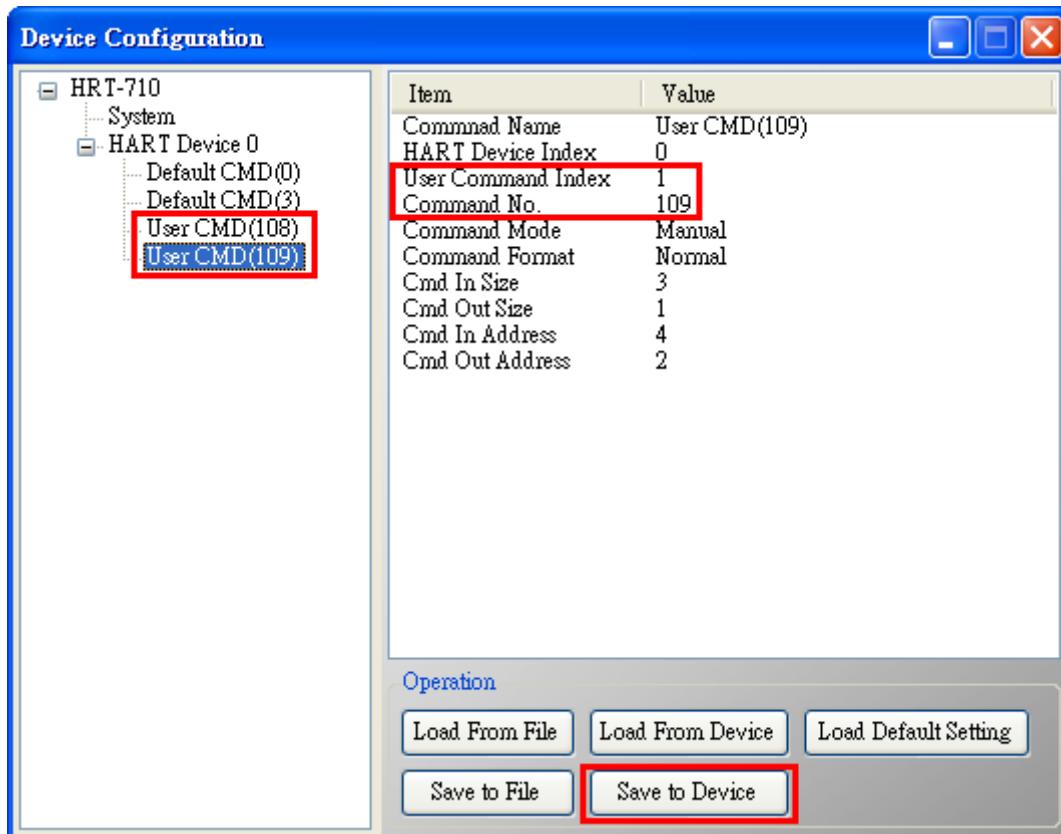
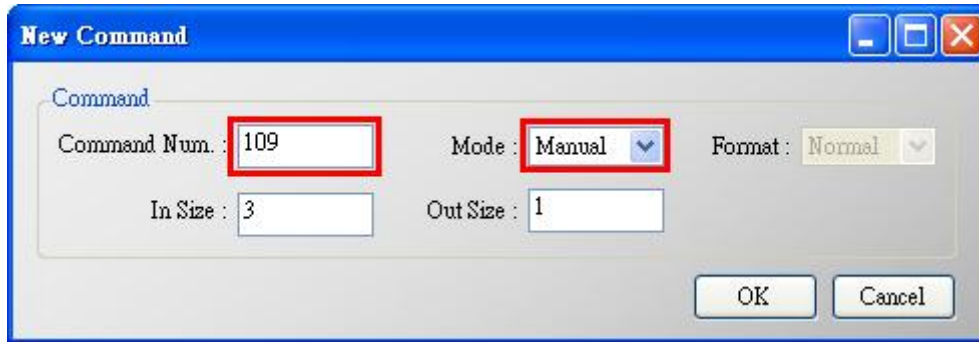

3. Set the value for the HART CMD 108. (HART CMD 108 sent not yet)

(1) There are one byte parameter in HART CMD 108.

(Ex: **The writing value 3(0x03)**=> It means that when HART device is in the burst mode, HART CMD 3 data will be sent from HART device automatically and periodically.

(2) Modbus command for the function is as below.

=> 01 06 00 00 03 00 89 3A

(3) After sending the above Modbus command, users can check if these values have been set successfully via HG_Tool..

[1] In the “**Device Information**” page, click the right button of mouse on the “**User CMD(108)**” item and choose the “**Advanced operation**” option.

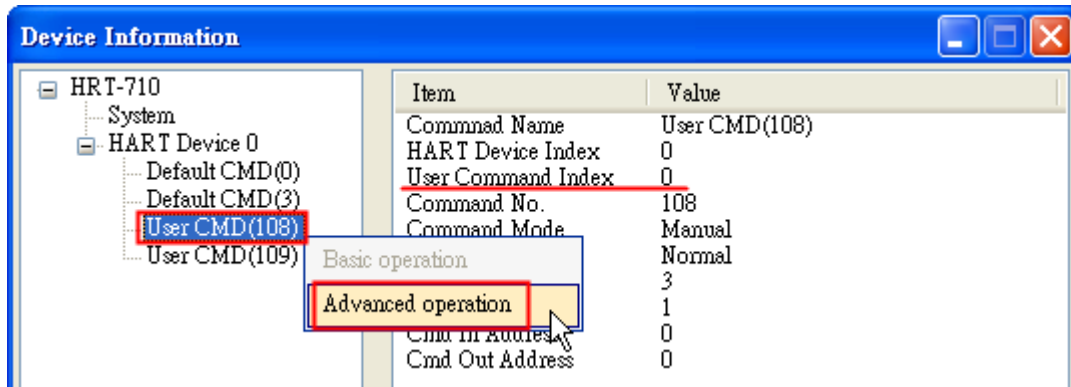

[2] In the “I/O Data” page, click the “Update” button and it will show the value for sending of UserCMD in the corresponding byte address in the “Output Data” area. Users can see the value of “3” been set successfully.

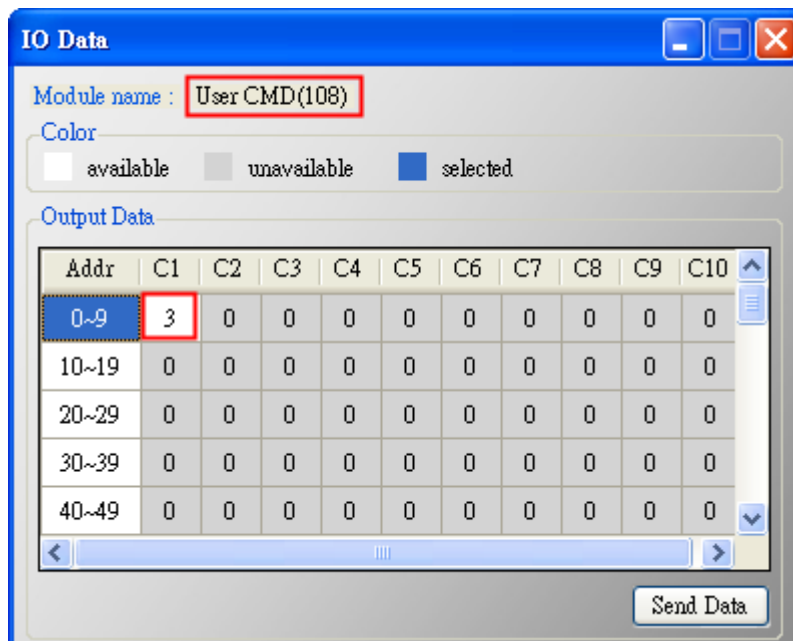

4. Trig the HRT-710 to send the UserCMD0 (HART command 108)

(1) Stop the original HART polling command and send the UserCMD0.

The Modbus command will be as below.

=> 01 06 **01 F5** **00 00** 98 04

=> 01 06 **01 F6** **01 00** 69 94

[1] **00** : Stop all the original HART polling command.

[2] **00** : Set the UserCMD no. for sending.

[3] **01** : Trig to send the UserCMD and it needs the different value every time.

(Ex: the next value will be 2, 3, 4 ...)

=> Now the UserCMD0 (HART command 108) has been sent.

5. Set the value for the HART CMD 109. (HART CMD 109 sent not yet)

(1) There are one byte parameter in HART CMD 109.

[1] **The writing value 1(0x01)**=> It means HART device burst mode will be enabled.

[2] **The writing value 0(0x00)**=> It means HART device burst mode will be disabled.

(2) Modbus command for the function is as below.

[1] Enable Burst mode => 01 06 00 01 01 00 D9 9A

[2] Disable Burst mode => 01 06 00 01 00 00 D8 0A

(3) After sending the above Modbus command, users can check if these values have been set successfully via HG_Tool..

[1] In the “**Device Information**” page, click the right button of mouse on the “**User CMD(109)**” item and choose the “**Advanced operation**” option.

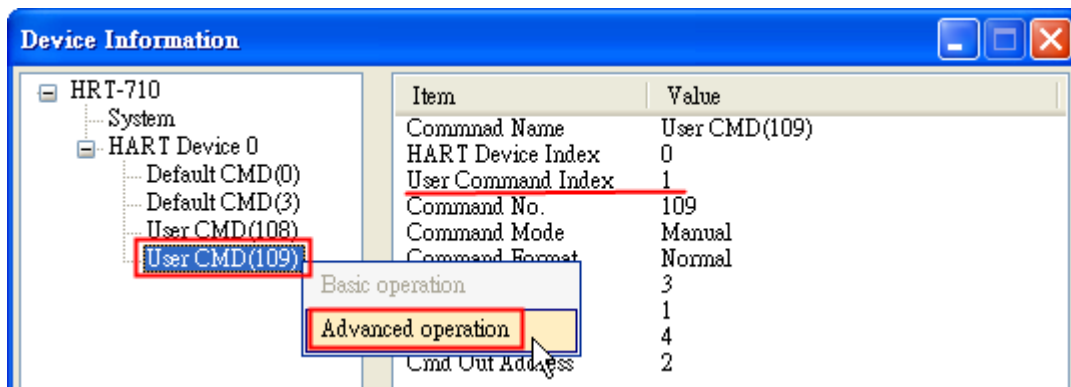

[2] In the “**I/O Data**” page, click the “**Update**” button and it will show the value for sending of UserCMD in the corresponding byte address in the “**Output Data**” area. Users can see the value of “1” been set successfully.

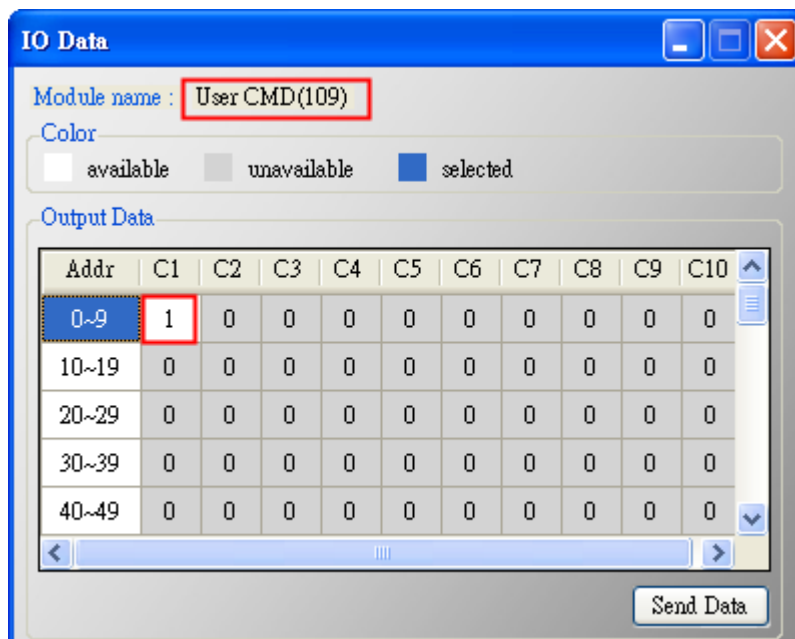

6. Trig the HRT-710 to send the UserCMD1 (HART command 109)

(1) Stop the original HART polling command and send the UserCMD1.

The Modbus command will be as below.

=> 01 06 **01 F5** **00 00** 98 04

=> 01 06 **01 F6** **02 01** A8 A4

[1] **00** : Stop all the original HART polling command.

[2] **01** : Set the UserCMD no. for sending.

[3] **02** : Trig to send the UserCMD and it needs the different value every time.

(Ex: the next value will be 3, 4, 5 ...)

=> Now the UserCMD1 (HART command 109) has been sent.

7. Recover the original HART polling command.

(1) The Modbus command will be as below.

=> 01 06 **01 F5** **01 00** 99 94

[1] **01** : recover all the original HART polling command.

Q19 : How to reset totalizer value by sending Device-Specific command?

A19: (2017/11/28)

[Case Example]

1. A user wants to use HRT-710 to reset the totalizer value from instrument KROHNE ESK4 by sending HART command 137.

[Solution]

1. Users must get the HART Device-Specific command first. The HART command No.137 format of KROHNE ESK4

Command #137: Reset Totalizer

Request Data Bytes

Byte	Format	Description
None		Resets the Totalizer Value to Zero

Response Data Bytes

Byte	Format	Description
None		

Figure 19-1 CMD137's frame format of KROHNE ESK

2. Add UserCMD CMD137 of ROHNE ESK4 to HRT-710:

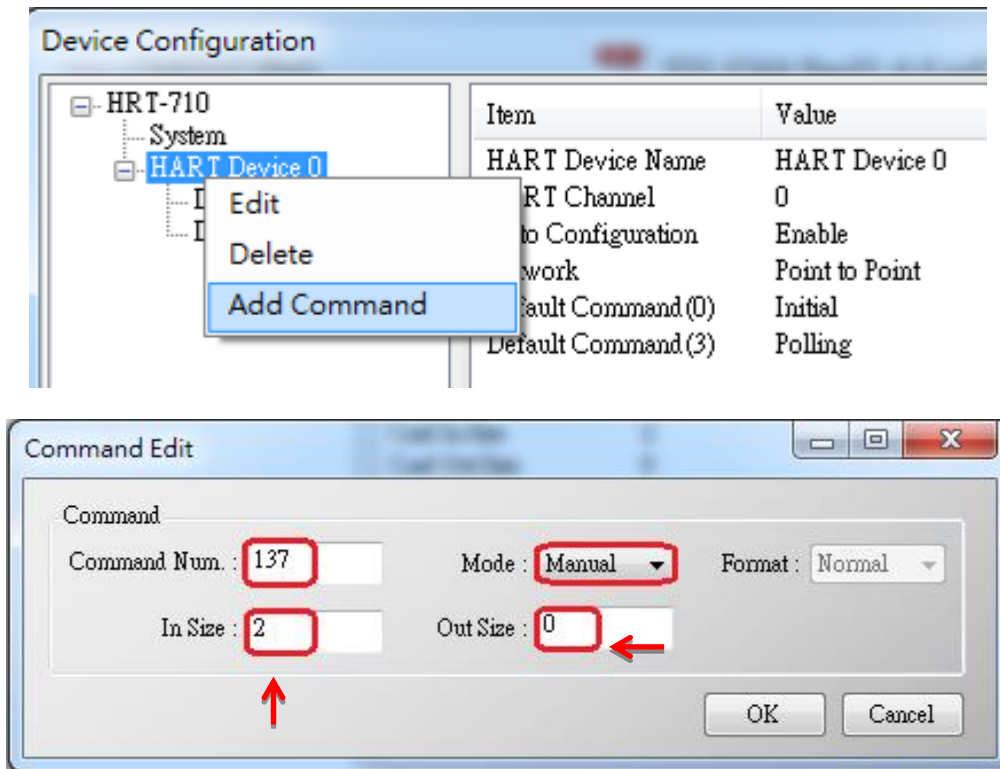

Figure19-2 Add HART command 137 to HRT-710

3. After finished settings, click **“Save to Device”** button in Device Configuration to save all the settings.

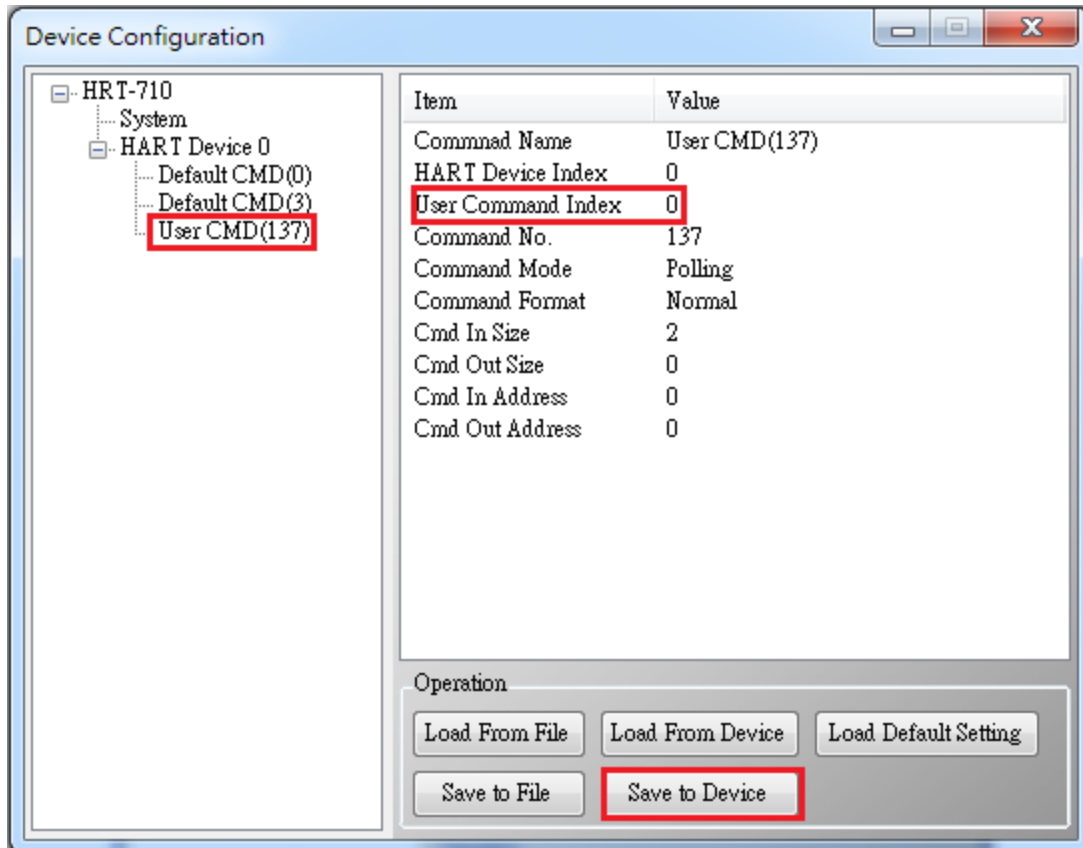

Figure19-3 Save settings to HRT-710

4. Trig the HRT-710to send UserCMD0 (HART command 137) ◦

(1)Stop the original HART polling command and send UserCMD0

(2)The Modbus command will be as below:

=> 01 06 01 F5 00 00 98 04

=> 01 06 01 F6 01 00 69 94

[1] 00 : Stop all the original HART polling command

[2] 00 : Set the no. of UserCMD for sending

[3] 01 : Trig to send the UserCMD and it needs the different value every time. (Ex: the next value will be 2,3,4 ...)

=> Now the UserCMD0 (HART command 137) has been sent.

5. Recover the original HART polling command

(1)The Modbus command will be as below:

=> 01 06 01 F5 01 00 99 94

[1] 01 : recover all the original HART polling command

Q20 : How to read total-flow data from flow-meter?

A20: (2018/04/10)

[Case Example]

1. A user wants to use HRT-710 to read the total-flow value from SIEMENS instrument FUS060.

[Solution]

1. According to the user manual of FUS060, device specific CMD130 is for reading total value and there are 3 values with 4 bytes length each, so the total data length is 3*4 = 12 bytes

HART command list					
Command #	Name	Operation	Parameters	Type	Bytes
130	read_HART_dynamic_variables	read	func6_TOT_total_value, func7_TOT_total_value, func3_TOT_total_value	FLOAT FLOAT FLOAT	4 4 4

Adding device specific command to HG_Tool requires to enter in and out data bytes, the in and out data here should include a 2 bytes response code.

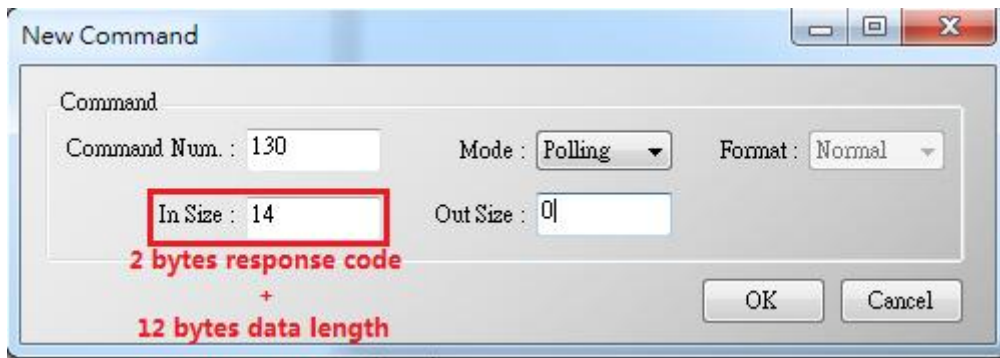

2. After adding the CMD130, please check whether it works properly by checking from the Advanced operation from Device Information and analyse with the IEEE754 Converter provided by HG_Tool Format Translation function.

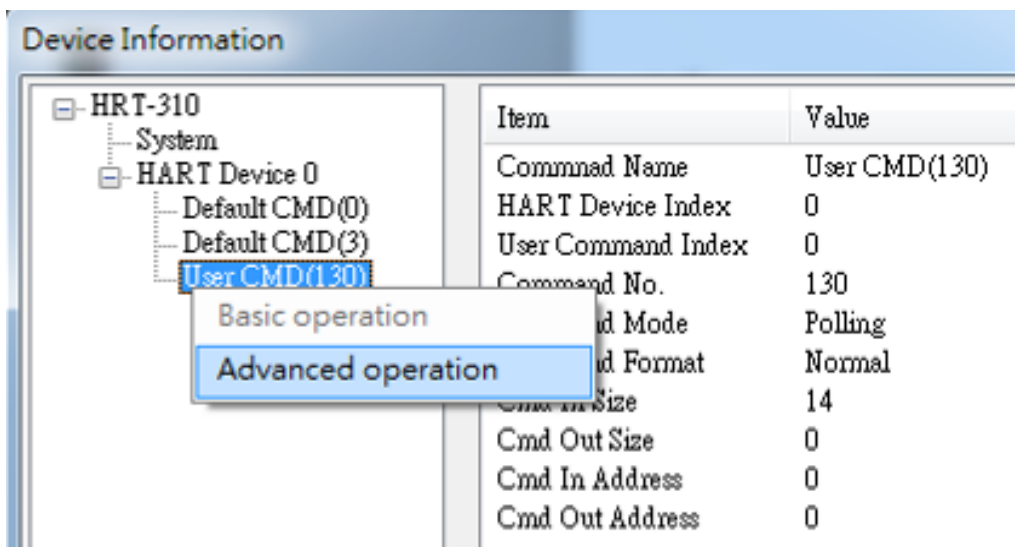

3. After making sure the settings in HG_Tool are all properly done, Modbus tools can be used to testify. ModScan has been used as an example here:

(1) HRT-710 records device specific command data from Modbus address 0~499

MB_Addr (HEX)	MB_Addr (Decimal)	Description
[User CMD Data]		
0~1F3	0~499	"User CMD" data

(2) Because ModScan is a 1-based (instead of starting from 0) software, so the address should be from 1~500

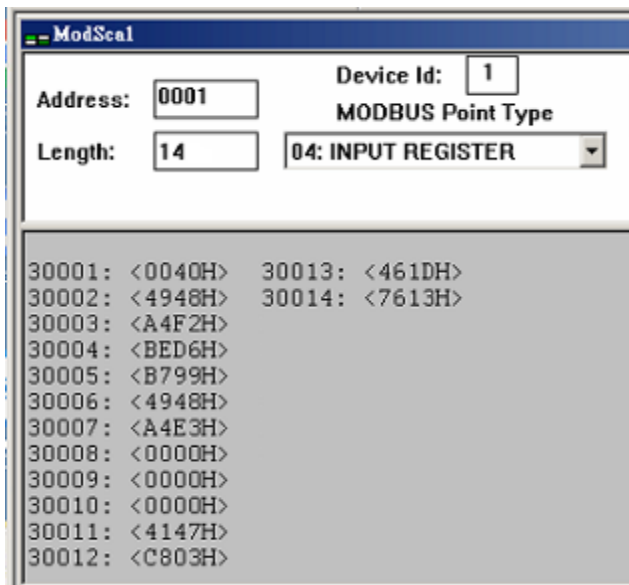

(3) The first 2 Bytes are response code, so the data starts from address 2

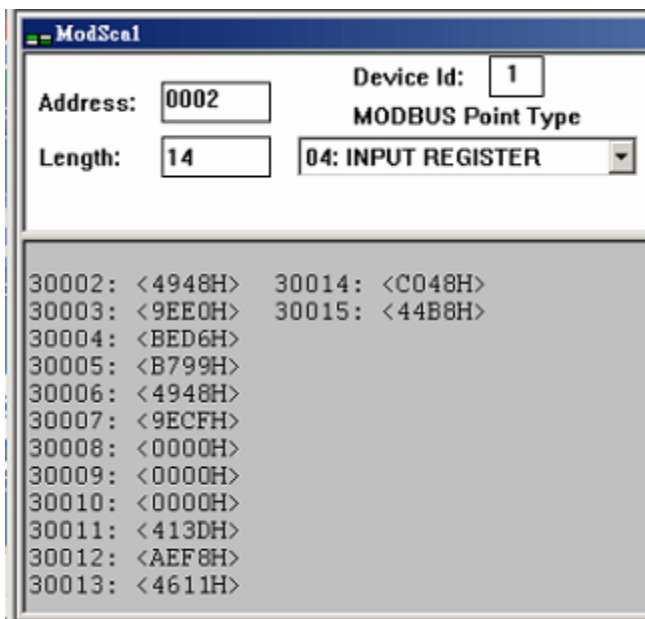

Q21 : HART communication update period calculation and adjustment

A21: (2018/08/02)

1. HART communications update period calculation :

Settings shown as below will be used as example: (HRT-310 with 2 HART devices)

1) HRT-310 parameters setting as below:

- [1] HRT-310 sends CMD0 and CMD3 to both HART instruments
- [2] CMD0 sets as Init mode, CMD3 sets as Polling mode
- [3] Cmd Interval sets as 1000 ms

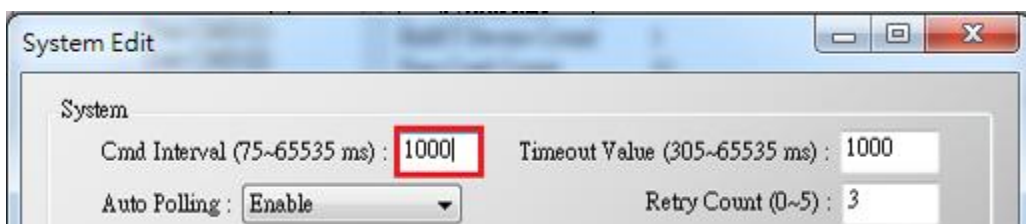
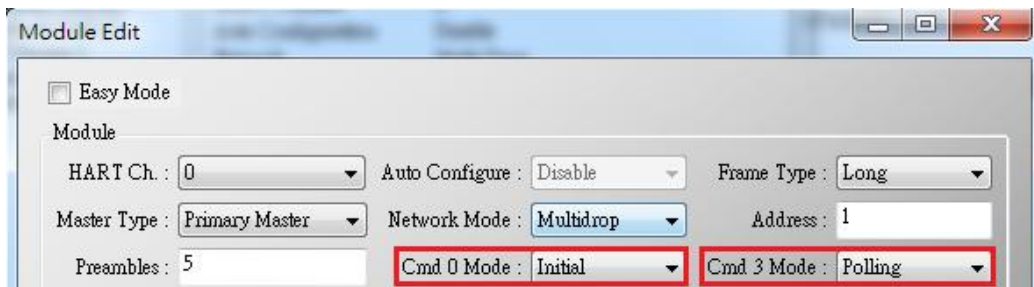
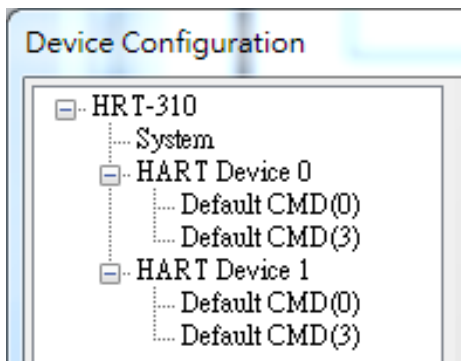

2) The HRT-310's update period of all HART instruments' data is:

[1] Init commands (CMD0) communication time:

HRT-310 will send CMD0 to short frame address from 0 and stops until finds all devices. As the settings shown above, Device 0 and 1 has short frame address of 1 and 2, so CMD0 will be sent 3 times. Communication time is:

$$3 * 1000 = 3000 \text{ ms}$$

Note: Because CMD0 is Init command, it will only be executed when HRT-310 booted up, so it **does not affect HART communication update period**.

[2] Polling commands (e.g. CMD3) communication time:

HRT-310 will send Polling commands to each HART device sequentially. As the settings shown above, there are total of 2 HART instruments and only 1 Polling command (CMD3) is required to be sent for each device. Therefore communication time is:

$$2(\text{Devices}) * 1(\text{Polling CMD}) * 1000(\text{ms}) = 2000 \text{ ms}$$

=>Conclusion: HART communication update period is the total time taken to send all Polling commands. So the update period here is 2000 ms

2. HART communication update period adjustment :

1) Shorten HART communication update period

[1] Delete unnecessary HART polling commands

The default settings of HART gateway contains 1 HART device and multiple HART commands, shown as below

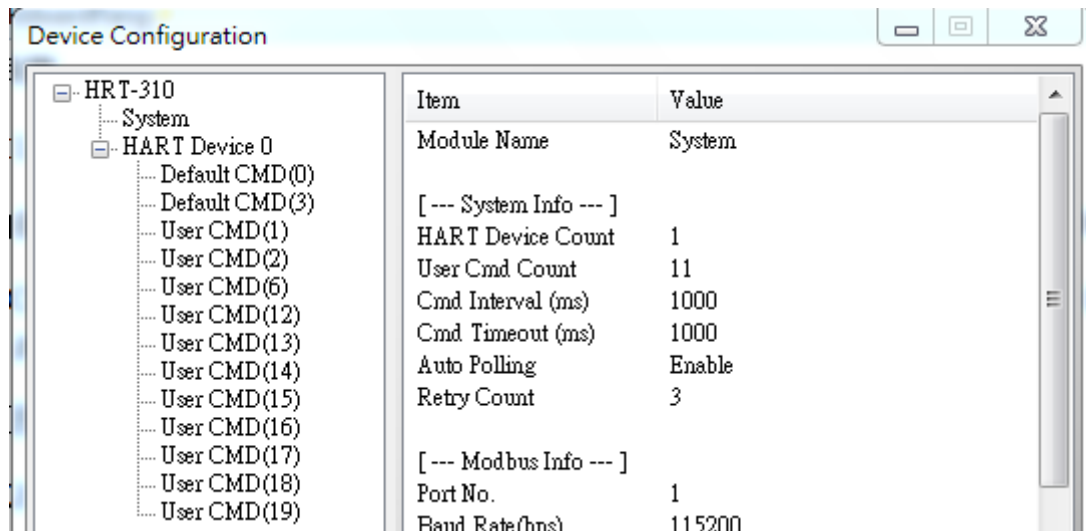

In order to shorten HART device update period, it is recommended to delete the whole device and then add a new device setting. (Refer to FAQ Q01)

[2] Shorten HART command interval

Right click on the System item and select Edit, reduce the time for Cmd Interval, 500 ms is suggested to be the minimum command interval.

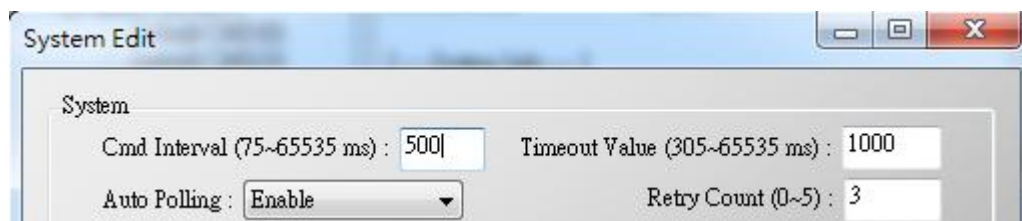

2) The communication update period for HRT-310 to collect all devices data is:

$$2(\text{Devices}) * 1(\text{Polling CMD}) * 500(\text{ms}) = 1000 \text{ ms}$$

Q22 : Integrate HART communication to traditional AI structure

A22: (2018/10/29)

1. The existing AI loop system:

1) Device analog signal collected by AI module

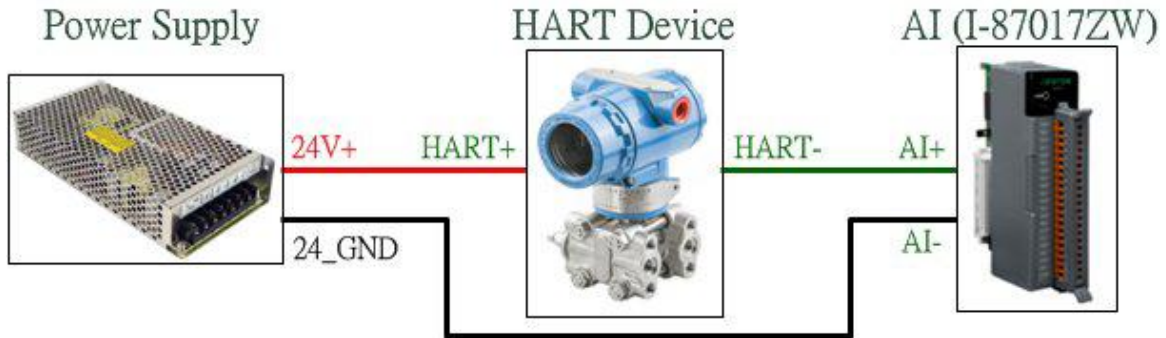

2. Integrating HART communication to collect more HART device information:

1) Integrating HART Gateway to the existing system, new system as follow:

2) Switch off HART Gateway built-in resistor and parallel connecting to AI module

=> Additional HART communication function integrated to existing system.

Note: The HART loop resistor in HRT-310/HRT-710 needs to be set disabled.

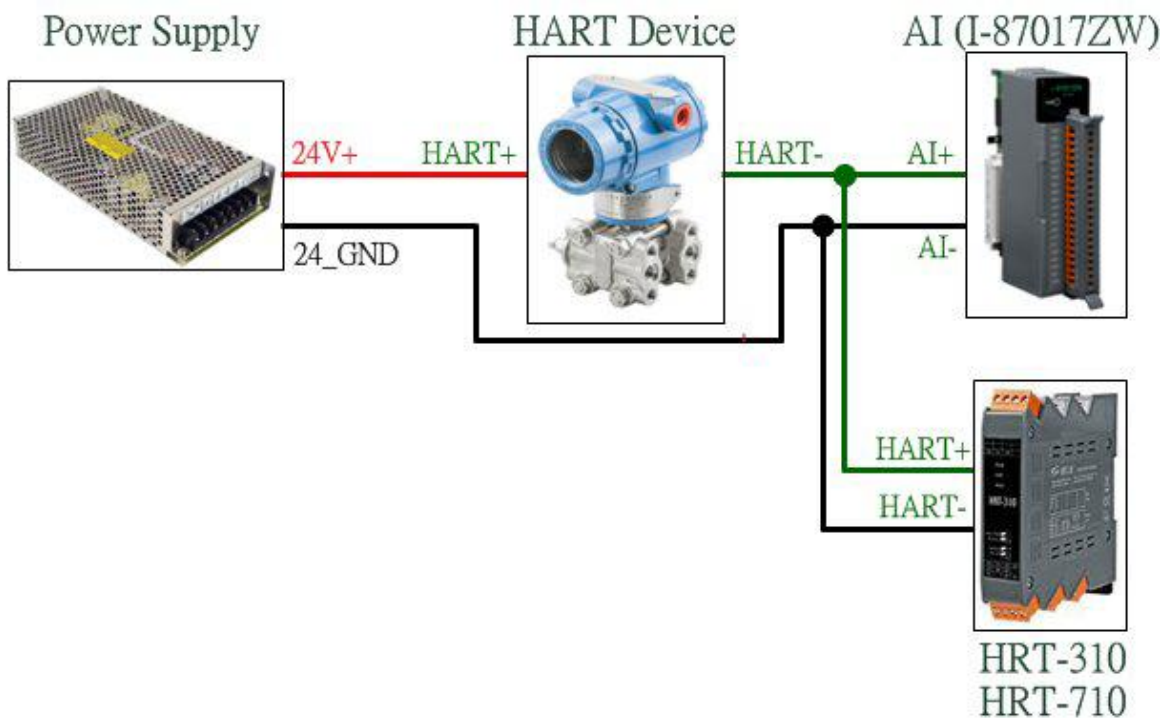

3. If AI readings of the initial system get disturbed after HART gateway added:

1) Using HART Filter (HRT-370) to split HART digital signal and AI analog signal

=> new system as follow:

Note: The HART loop resistor in HRT-310/HRT-710 needs to be set disabled.

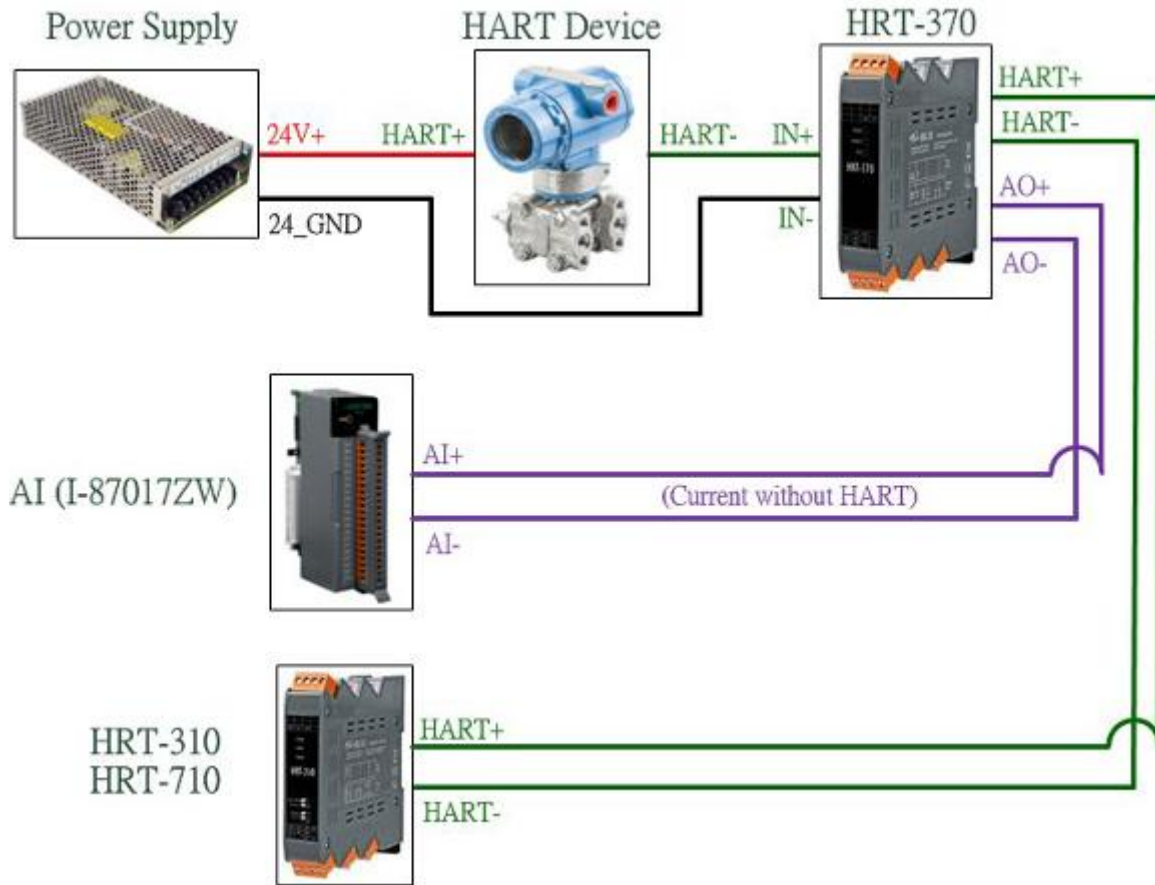

Q23 : HART Multi-drop mode precautions

A23: (2018/10/29)

Hardware:

1. HART devices address must set in between 1~15 and no repeated.

1) Please first set the HART address for each HART device one by one, then adding all to the HART Multi-drop loop.

2. Wiring for HART Multi-drop mode is as follow:

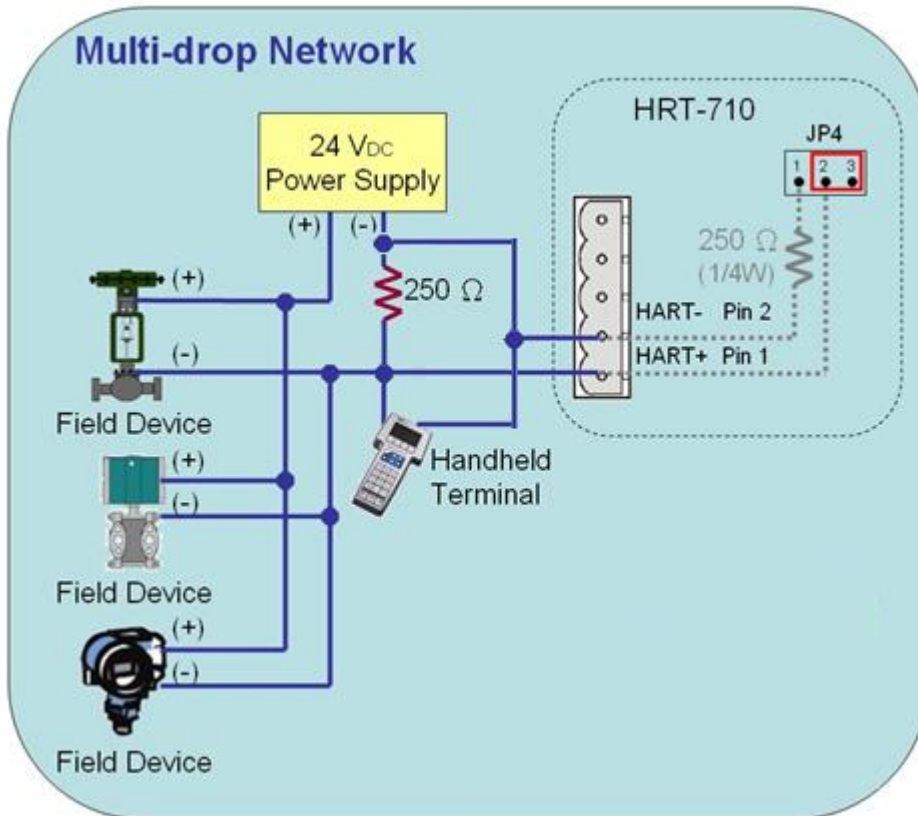

3. Start building structure from 2 HART devices

1) To avoid situation that when error occurs and not knowing how to debug, it is recommended to start building structure with only 2 devices and adding 1 more device at a time if no error occurs until all devices been added.

4. Make sure the HART loop resistance is 250 Ω

1) Please measure if the resistance is around 250 Ω in between Module's (ex. HRT-710) HART+ / HART-

5. Choose HART loop resistor when connecting to 7 or more HART devices

1) HRT-710 and HRT-711 with hardware version earlier than V1.30:

When connecting more than 7 HART devices, built-in resistor (250 Ω , 1/4W) may be burned, therefore suggesting use an external resistor (250 Ω , 1W)

2) HRT-710 and HRT-711 with hardware version from V1.30 and later:

Module upgraded built-in resistor to $250\ \Omega$ (2W), therefore no need to worry

=> HRT-310 designed to use built-in resistor of $250\ \Omega$ (2W) at first place, therefore no need to worry about this issue

6. Check the voltage in between HART device (Be aware of voltage drop)

When connecting more HART devices, the voltage available between devices + / - drops and devices may not be able to turned on. Example as follow:

In Multi-drop mode, every HART device provides extra 4mA to HART loop, if customer uses a 24V power supply, the voltage between HART devices should be as follow:

1) Connecting 1 HART device:

Loop current: **4mA**; Loop resistance: **$250\ \Omega$** => Voltage drop in the resistor: **1V**; therefore voltage left for devices: **$24V-1V=23V$**

2) Connecting 10 HART devices:

Loop current: **40mA**; Loop resistance: **$250\ \Omega$** => Voltage drop in the resistor: **10V**; therefore voltage left for devices: **$24V-10V=14V$**

3) Connecting 11 HART devices:

Loop current: **44mA**; Loop resistance: **$250\ \Omega$** => Voltage drop in the resistor: **11V**; therefore voltage left for devices: **$24V-1V=13V$**

(If HART device needs 14V or above voltage to work well, then the case will cause HART communication failed)

=> When connecting to multi HART devices, all HART devices can't be communicated. (For example, when connecting to 9 HART devices, HART communication is ok. But connecting to 10 HART devices, all HART devices can't be communicated.) Please follow the below method to improve the problem.

< Method 1: Adopt the external resistor > (refer to section 2.3.4 for HART wiring)

[1] Disable the internal resistor of HRT-310 / HRT-710. (refer to section 2.6)

[2] Adopt the external resistor 150 ohm or 100 ohm for testing. (It is used to reduce the voltage drop in the loop resistor.)

< Method 2: Adopt the power supply with higher voltage >

[1] Adopt the power supply more than 24V (like 28V or 36V).

Software Configuration (HG_Tool):

1. Set Module Address between 1~15 in Module Configuration.

Module

HART Ch. :	0	Auto Configure :	Disable	Frame Type :	Long
Master Type :	Primary Master	Network Mode :	Multidrop	Address :	1
Preambles :	5	Cmd 0 Mode :	Initial	Cmd 3 Mode :	Polling

Q24 : HART communication distance issues

A24: (2019/02/23)

1. When installing HART network, communication distance needs to be considered. Please refer to below table for information about cable capacitance and length

No. Network Devices	Cable Capacitance – pf/ft (pf/m)			
	20 pf/ft (65 pf/m)	30 pf/ft (95 pf/m)	50 pf/ft (160 pf/m)	70 pf/ft (225 pf/m)
1	9,000 ft (2,769 m)	6,500 ft (2,000 m)	4,200 ft (1,292 m)	3,200 ft (985 m)
5	8,000 ft (2,462 m)	5,900 ft (1,815 m)	3,700 ft (1,138 m)	2,900 ft (892 m)
10	7,000 ft (2,154 m)	5,200 ft (1,600 m)	3,300 ft (1,015 m)	2,500 ft (769 m)
15	6,000 ft (1,846 m)	4,600 ft (1,415 m)	2,900 ft (892 m)	2,300 ft (708 m)

Source:

https://www.fieldcommgroup.org/sites/default/files/technologies/hart/ApplicationGuide_r7.1.pdf

2. If communication distance needs to be extended, please try following methods:

(1) Use Fiber to extend HART communication distance

HRT-227CS is HART to Single-Mode Fiber converter, specially designed to extend HART communication distance.

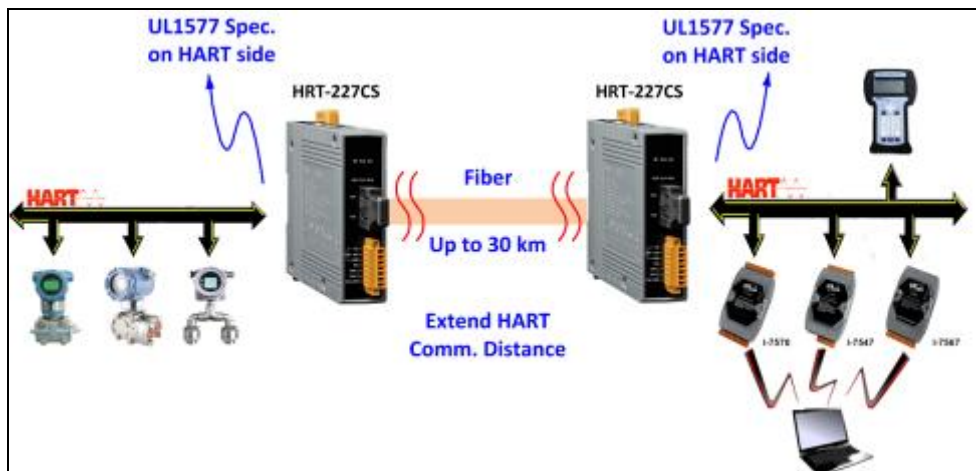

For more information, please refer to:

HRT-227CS user manual:

ftp://ftp.icpdas.com/pub/cd/fieldbus_cd/hart/converter/hrt-227cs/manual/

(2) Use Fiber to extend RS-485 communication distance

I-2541 and **I-2542 series** are RS-232/ 422/ 485 to Single-Mode Fiber converters, specially designed to extend Serial communication distance.

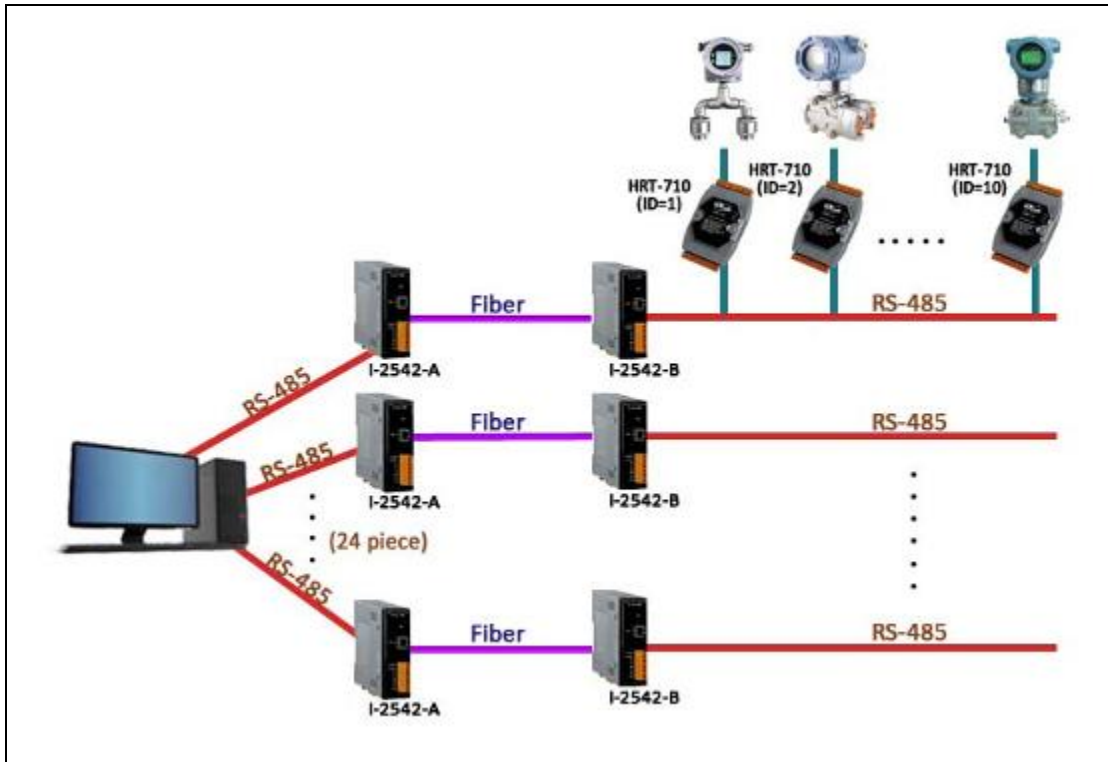

For more information, please refer to:

I-2541 user manual:

<http://www.icpdas.com/download/converter/manual/net-i2541.pdf>

I-2542 series user manual:

http://www.icpdas.com/root/product/solutions/datasheet/industrial_communication/I-2542-Release%20Note_V1%2000.pdf

(3) Use Fiber to extend Ethernet communication distance

ICP DAS provides various Ethernet to Fiber switch, below is an example of using **NS-205F** and **NS-209F** Ethernet switch to extend communication distance

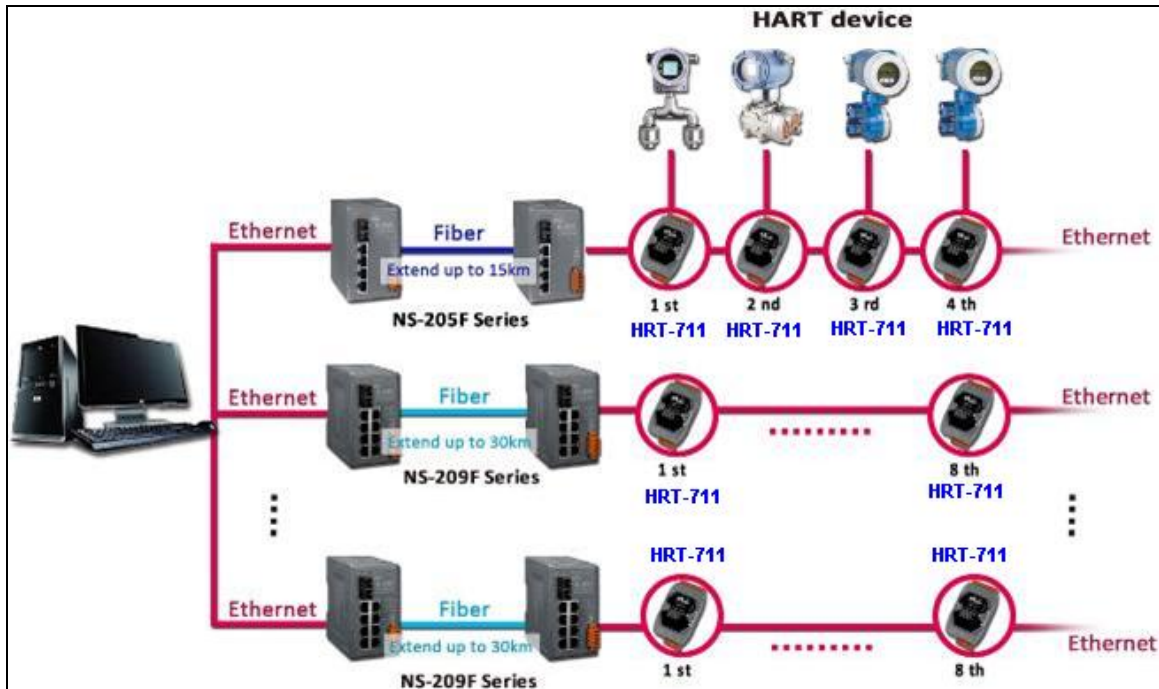

To find suitable Ethernet & Fiber switch, please check from:

http://www.icpdas.com/root/product/solutions/industrial_ethernet_switch/switch_selection.html#a

(4) Use Ethernet Switch to extend Ethernet communication distance

Similar to previous method, instead of using Fiber, simple Ethernet switch can also extend the communication distance

To find suitable Ethernet switch, please check from:

http://www.icpdas.com/root/product/solutions/industrial_ethernet_switch/switch_selection.html#a

Q25 : Using Through Mode of HG_Tool to Stop Burst Mode of HART Device

A25: (2019/08/28)

1. Run the HG_Tool and connect to HRT-710.

(1) Disable all the Polling command.

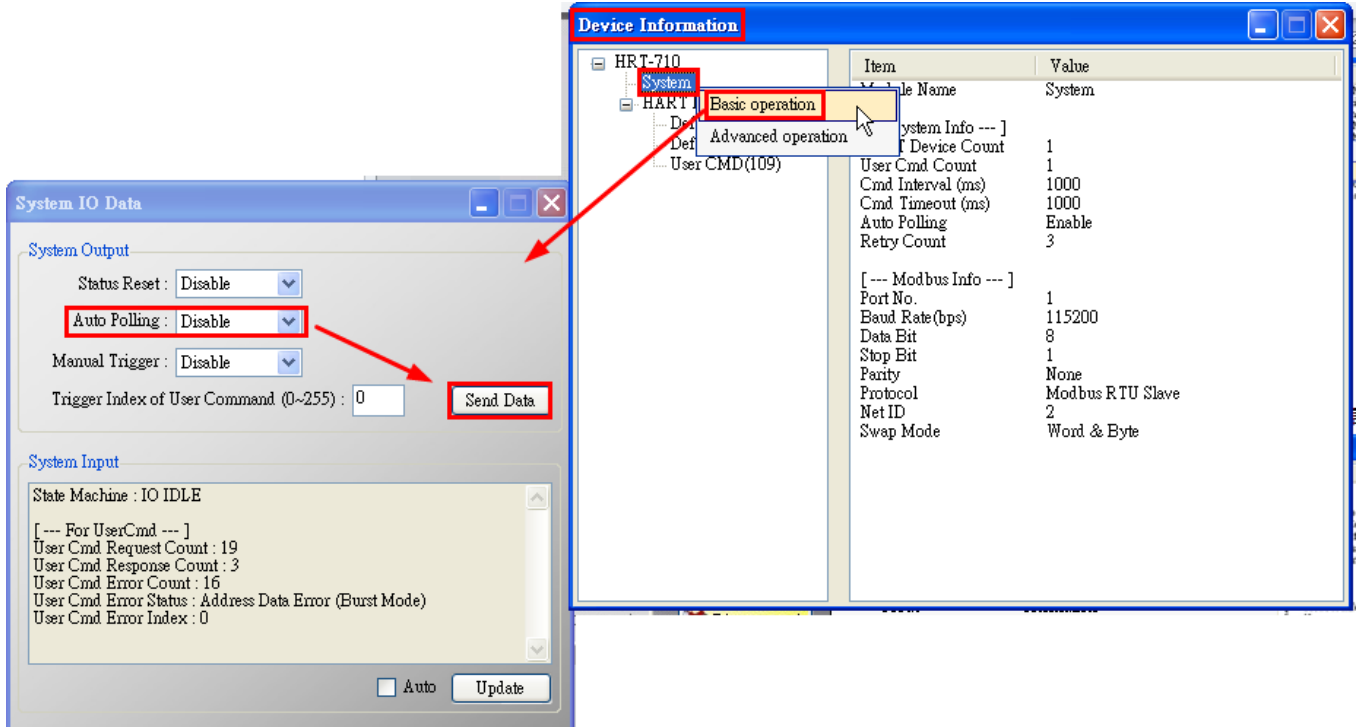

(2) Open the “Through Mode” and send HART CMD0 to get the “Long Frame Address” of HART device.

[1] HART CMD0 : FF FF FF FF FF 02 80 00 00

[2] Long Frame Address : 1A 0B 50 EB CD (As the below figure)

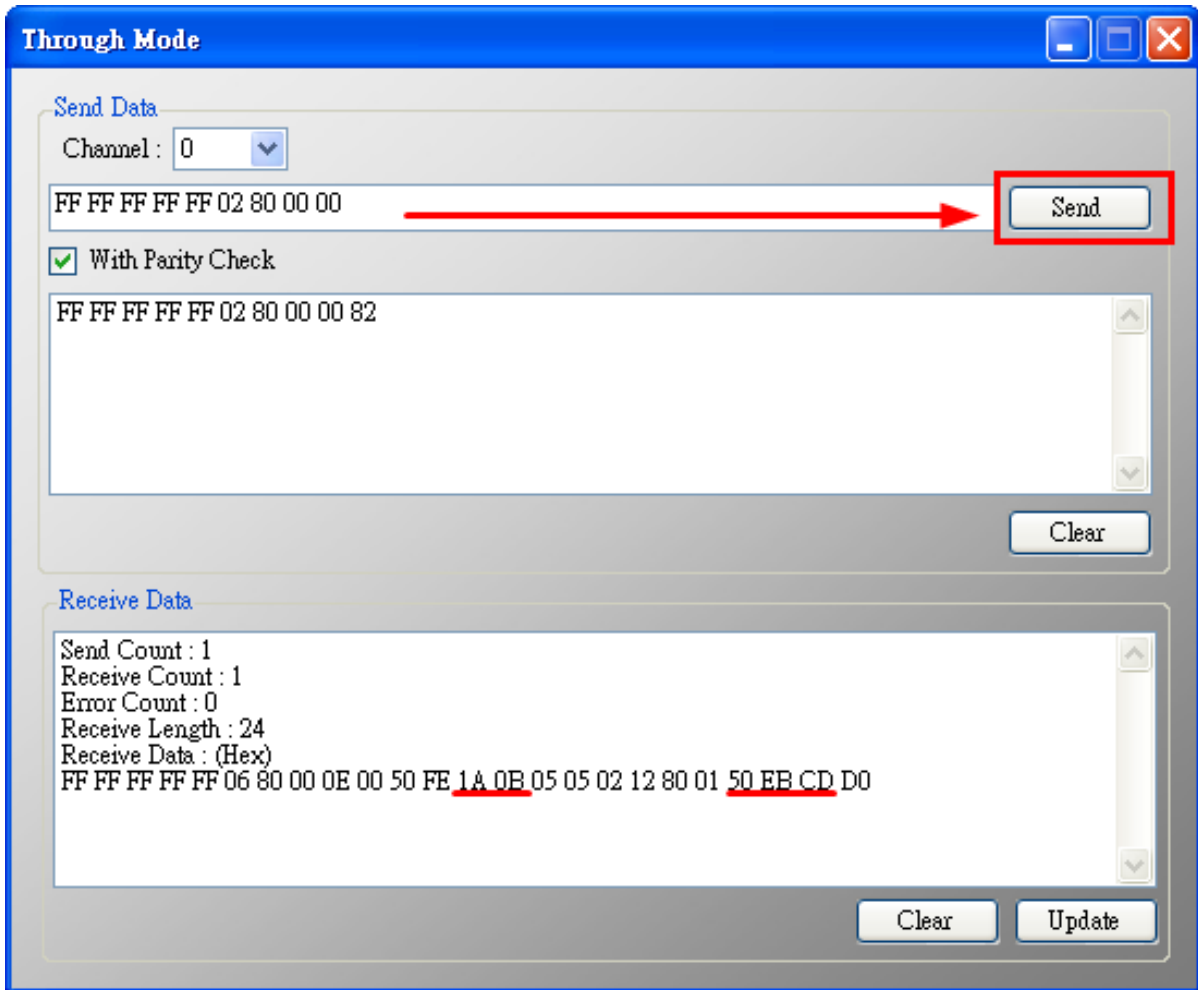

(3) Configure HART command 109 and send it to disable the burst mode of HART device.

[1] HART CMD 109 => Ex : **FF FF FF FF FF 82 DA 0B 50 EB CD 6D 01 00**

<1> FF FF FF FF FF : Preamble

<2> **82** : Delimiter (0x02 need to add **0x80** = 0x82)

<3> **DA 0B 50 EB CD** : Long Frame Address (Different from every HART device)
(0x1A need to add **0xC0** = 0xDA)

<4> 6D : HART command no. (0x6D = 109)

<5> 01 : Byte Count (HART command parameter byte)

<6> 00 : Data (HART command parameter content. 00 for)

Q26 : How to use the In_Offset field of the UserCMD ?

A26: (2020/08/19)

[Example]

1. A user wants to use HRT-710 to read the float data from instrument Endress-Hauser Promass F300 by sending HART command 158. (The float data doesn't arranged in two WORD of Modbus address) °
2. Run the example, users need to update the firmware of HRT-710 to be v1.09 and use HG_Tool_v1.5.0.

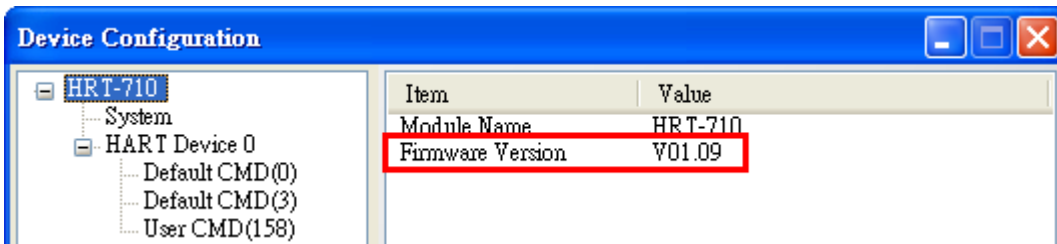

3. The format of HART command 158 is as below.
 (1) The start byte of the response float data is in byte3.

Request Data Bytes		
Byte	Format	Description
0-1	Unsigned-16	Parameter HART Index
2	Unsigned-8	Parameter Instance

Response Data Bytes		
Byte	Format	Description
0-1	Unsigned-16	Parameter HART Index
2	Unsigned-8	Parameter Instance
3-n	Value	float data

Fig 26-1 HART 158 format of Endress-Hauser Promass F300

4. Add the UserCMD of HART command 158 to HRT-710.

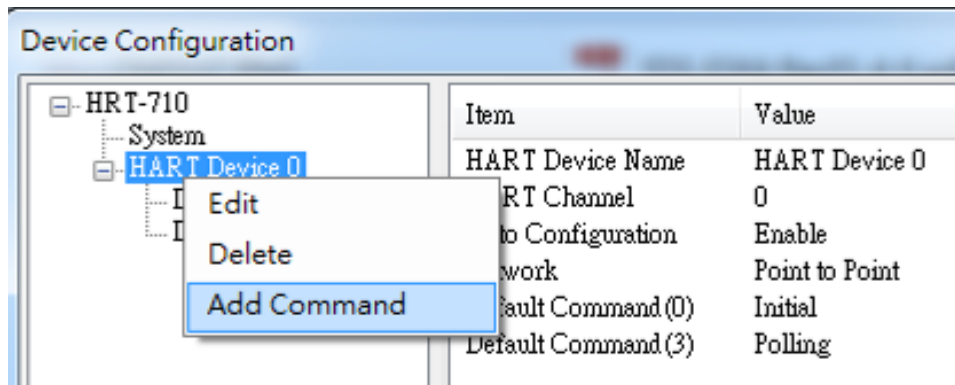

(1) Owing to the start byte of the response float data is byte3, so in the "In_Offset" field, users can fill with 3 to ignore HART response data byte0, 1, and 2. Then the response float data can be shown in the Modbus address easily.

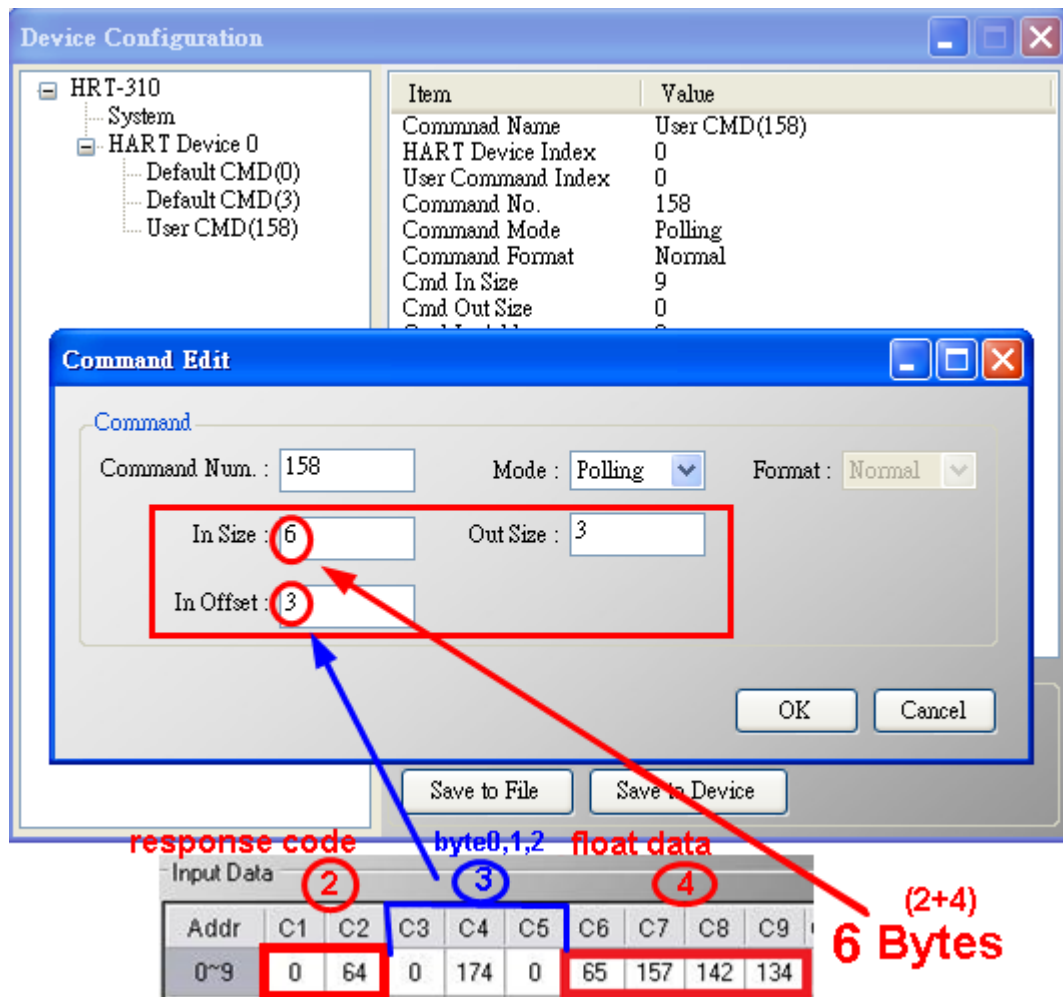
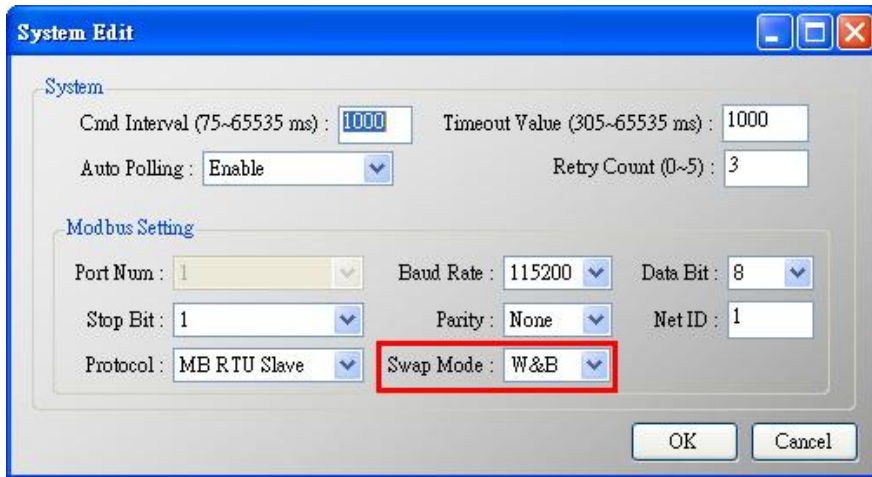

Fig 26-2 Add the UserCMD of HART command 158 to HRT-710

(2) In "System Edit" page, please set the "W&B" in the Swap Mode field.



5. After finished the settings, click “**Save to Device**” button in Device Configuration to save all the settings.

6. Trig the HRT-710 to send UserCMD0 (HART command 158). (refer to the steps of FAQ15)

7. Get the response data of HART command 158 via HG_Tool.

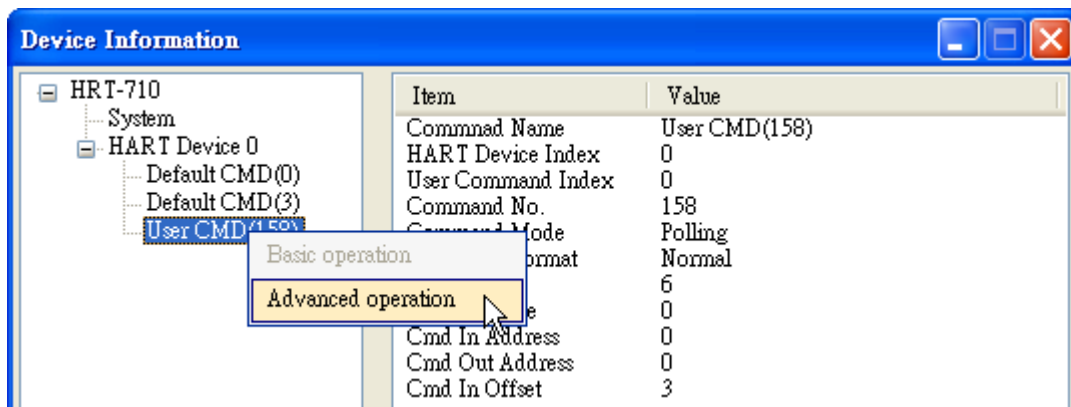

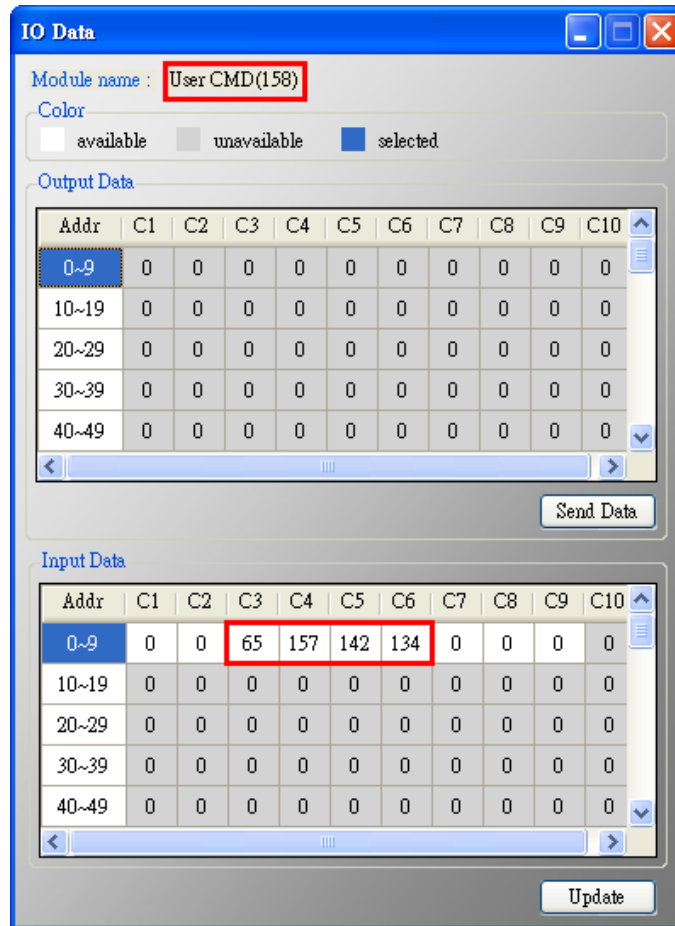

Fig 26-3 The response data of HART command 158

8. Get the response data of HART command 158 via modscan tool.

- (1) The Modbus first WORD data: the response code of HART command 158.
- (2) The Modbus second and third WORD data: the float data of HART command 158.

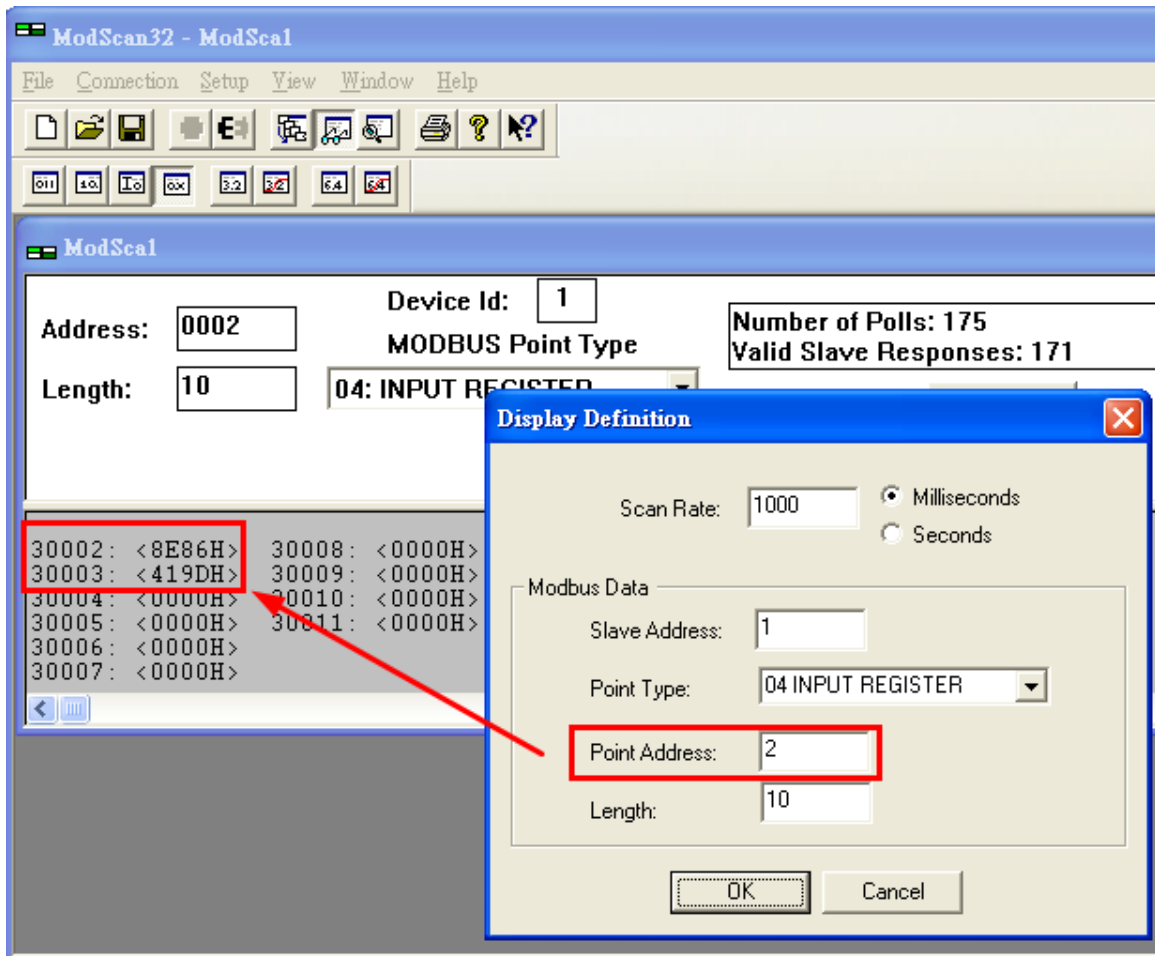

Fig 26-4 The response data of HART command 158 (Hex format)

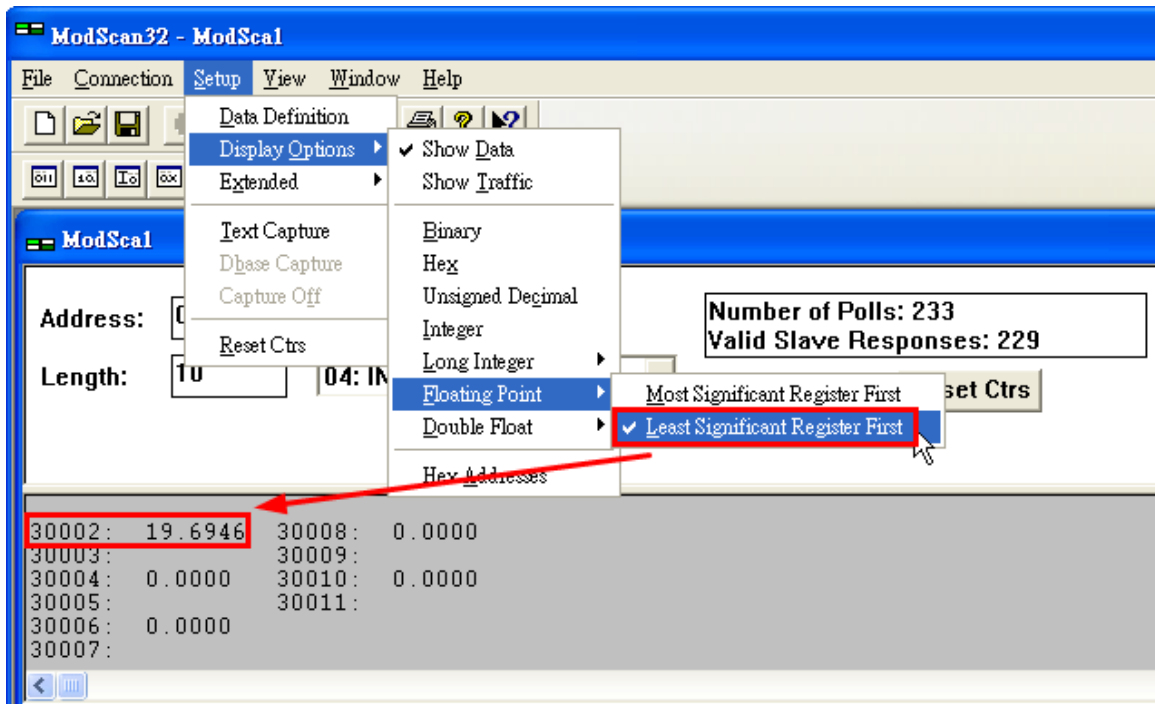

Fig 26-4 The response data of HART command 158 (float format)

Q27: How to use “Listen Only” function to get HART data?

A27: (2020/08/20)

[Example]

A user wants to get HART device data (like HART command3) in another PC via Modbus/RTU via the original HART network without interfering the original HART communication.

[Solution]

1. The HART “Listen Only” function had been supported in HRT-710 firmware v1.09. It means that HRT-710 doesn't send any HART command and just receive HART communication and then can get HART device data via Modbus.

2. Example-1: (There is just only one HART device in HART network)

(1) Using HDS (HART Device Simulator) software to set HART command 3 and 158 data as the below figure for HART device.

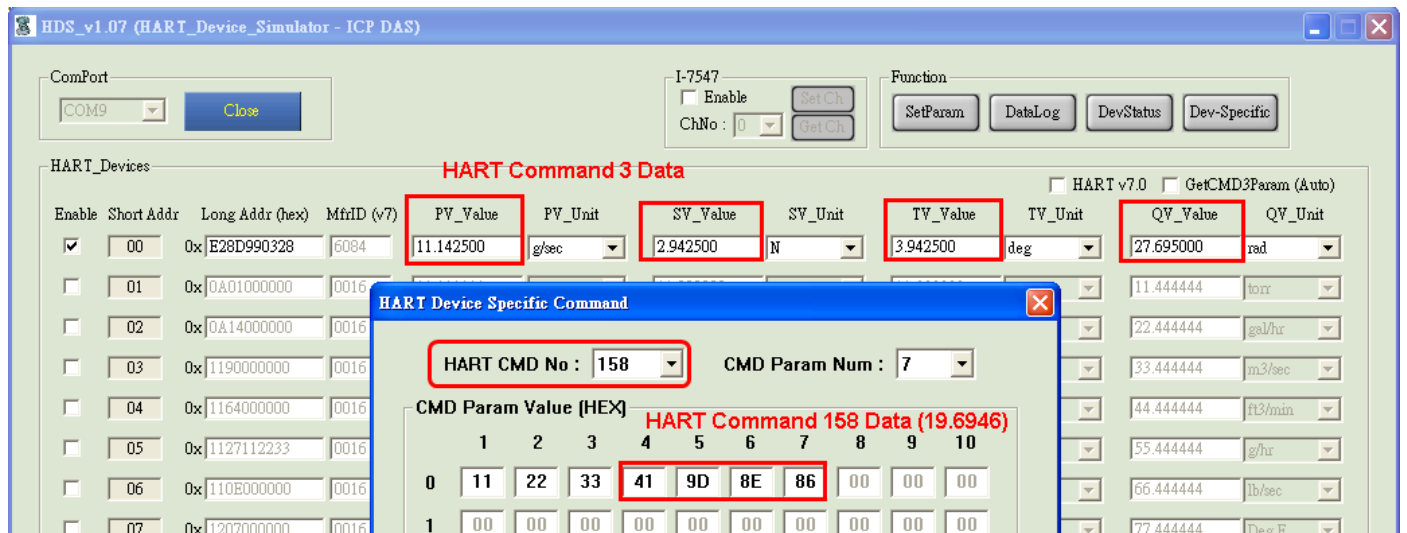

Fig 27-1 Set HART command 3 and 158 data in the HDS

(2) Add HART command 3 and 158 to HRT-710.

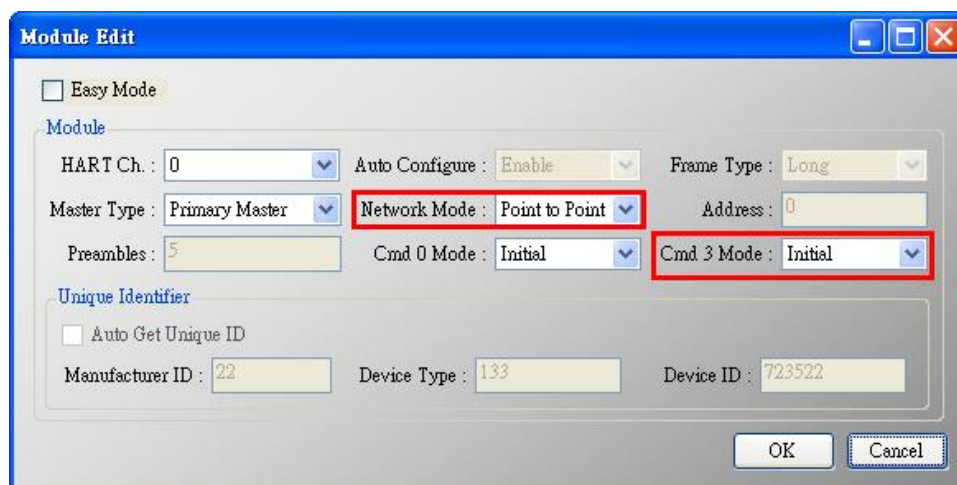

Fig 27-2 HART command 3 setting

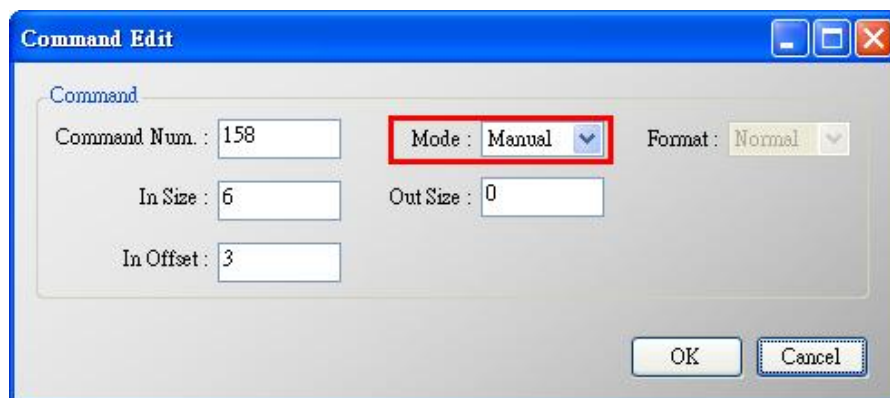

Fig 27-3 Add HART command 158 (UserCMD)

(2) In the "System Edit" page, Set "Auto Polling" to be "Disable"(HRT-710 will not send HART command) and set the "Swap Mode" to be "W&B".

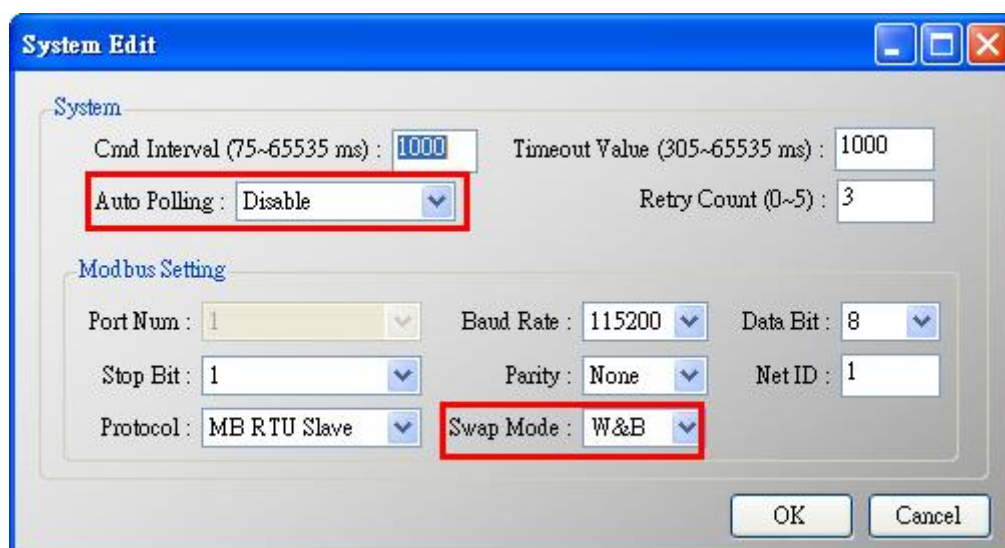

Fig 27-4 Set "Auto Polling" to be "Disable"

(3) After finished the settings, click "**Save to Device**" button in Device Configuration to save all the settings.

(4) Get the response data of HART command 3 and 158 via Modscan tool.

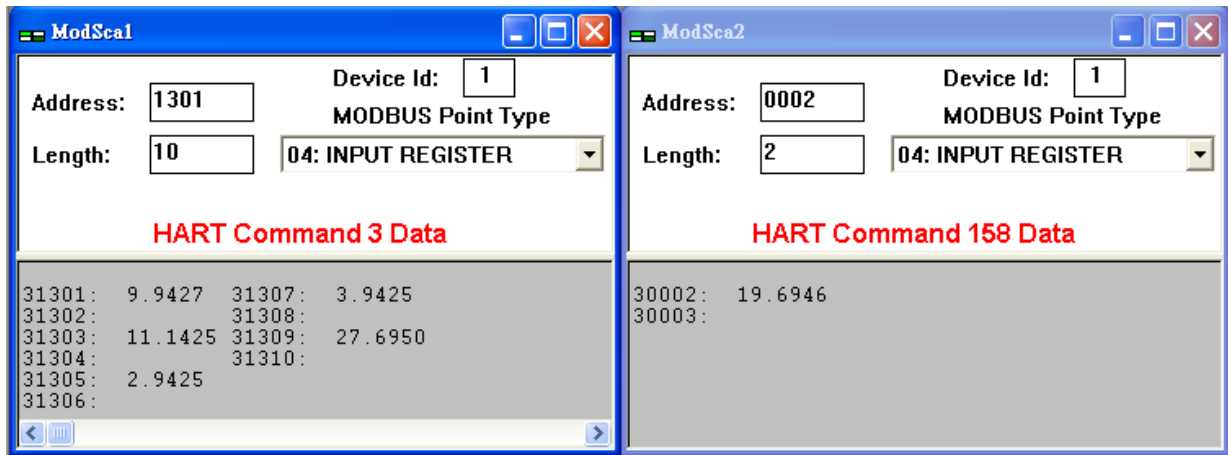

Fig 27-5 HART command 3 and 158 data shown in Modscan

3. Example-2: (There two HART devices in HART network)

- (1) Using HDS (HART Device Simulator) software to set HART device address 1 and address 3 and HART command 3 data as the below figure for these two HART devices.

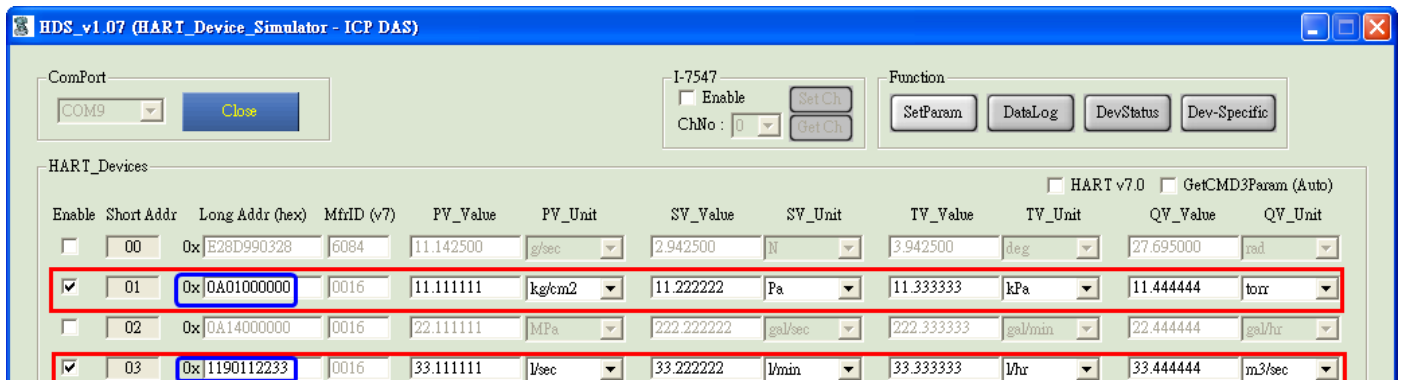

Fig 27-6 Set HART device address and command 3 data in HDS

- (2) Add HART device with address 1 and address 3 to HRT-710.

[1] Users need to un-check the “Auto Get Unique ID” checkbox and fill with the long frame address of HART device.

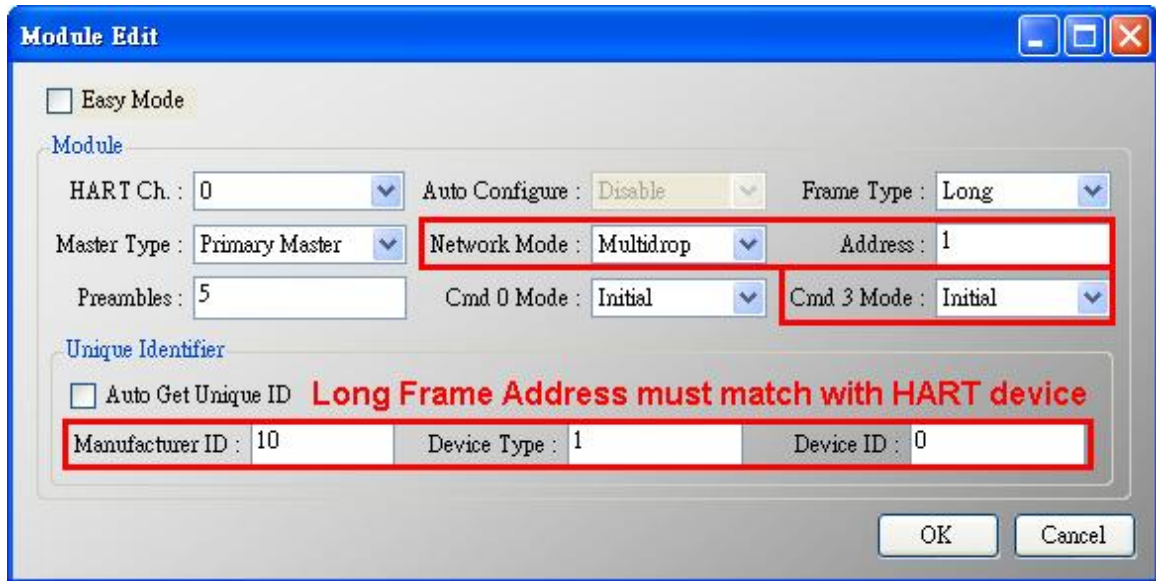

Fig 27-7-1 Add HART device with address 1 (0x0A0100000)

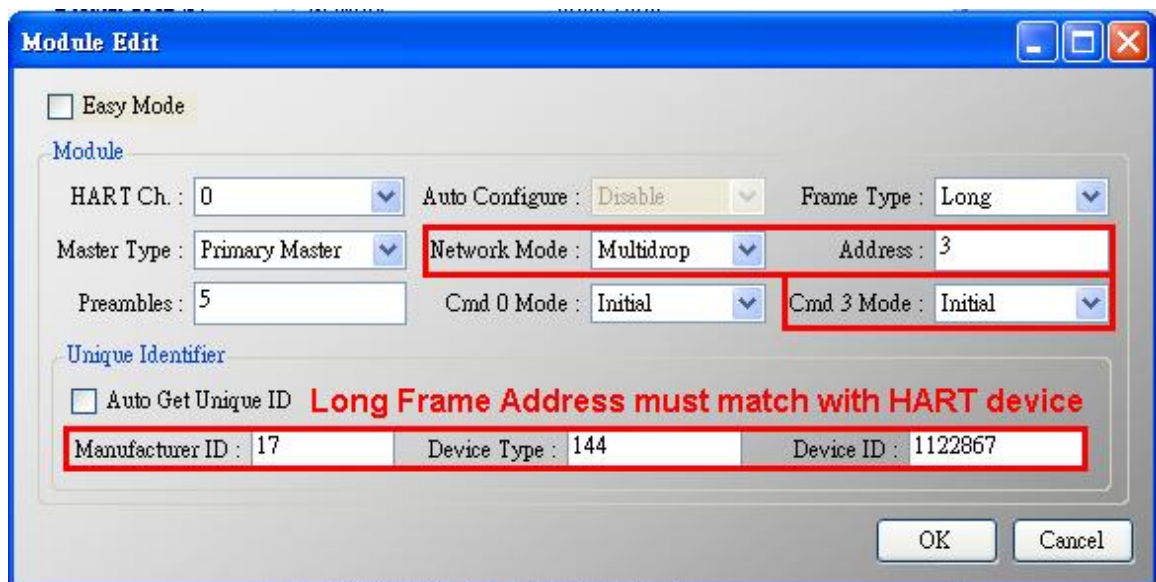

Fig 27-7-1 Add HART device with address 3 (0x1190112233)

(2) In the "System Edit" page, Set "Auto Polling" to be "Disable"(HRT-710 will not send HART command) and set the "Swap Mode" to be "W&B".

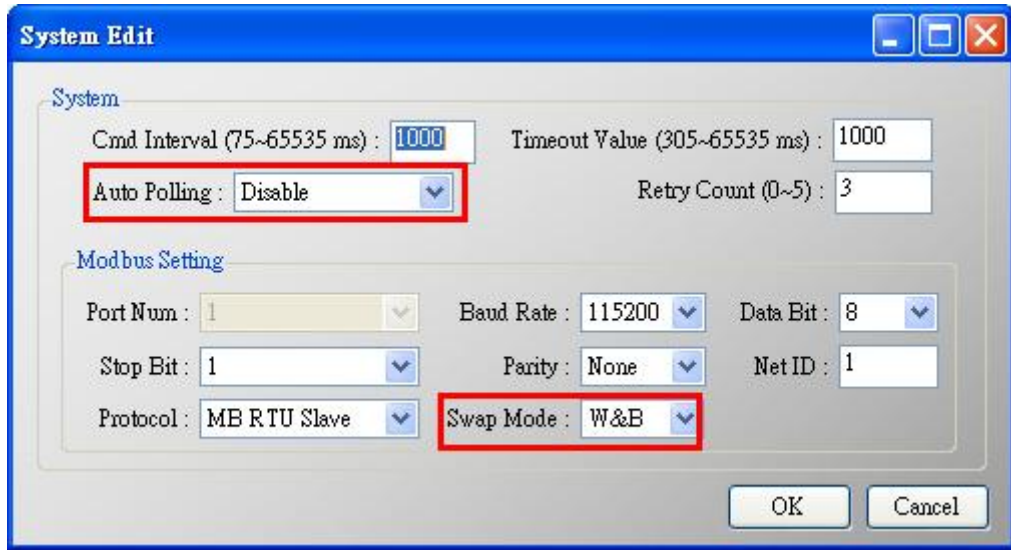

Fig 27-8 Set "Auto Polling" to be "Disable"

- (3) After finished the settings, click **"Save to Device"** button in Device Configuration to save all the settings.
- (4) Get the response data of HART command 3 of these two HART devices via Modscan tool.

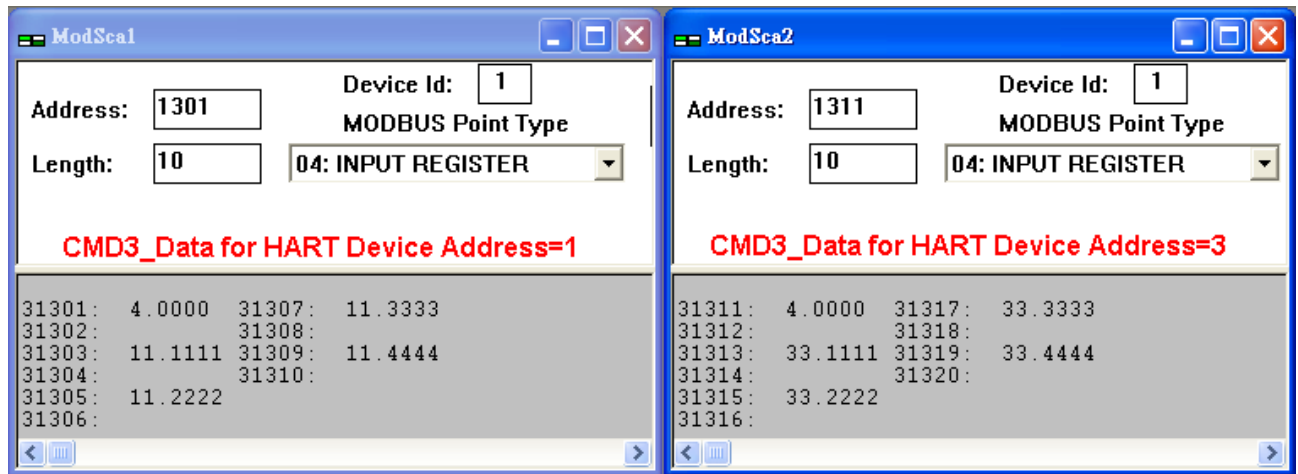

Fig 27-9 HART command 3 data of HART device address 1 and 3 shown in Modscan

Q28 : Using multiple HART CMD33 in “Listen Only” mode ?

A28: (2023/01/03)

[Example]

Owing to the different data of Request Data in HART CMD33, the response data will be different in HART CMD33. If users want to put the different response data in the corresponding Modbus address, users can add the multiple HART CMD33 to do that (need to set the data in the “Default Output Data” page). The below will use three HART CMD33 for example. (The function is supported in firmware v1.15 or above)

[Solution]

1. According the steps of FAQ Q27 , set HRT-7(3)10 to be “Listen Only” mode.
2. Add three HART command 33 ◦

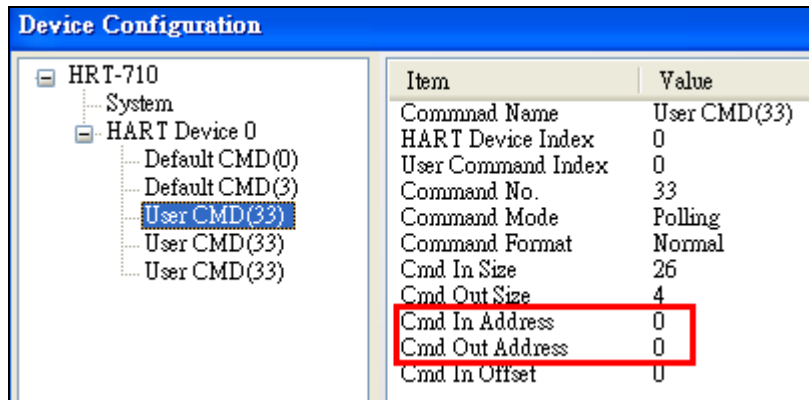

The screenshot shows the 'Device Configuration' window for HRT-710. The left pane shows a tree view with 'HART Device 0' expanded, and 'User CMD(33)' selected. The right pane shows the configuration for this command:

Item	Value
Commnad Name	User CMD(33)
HART Device Index	0
User Command Index	0
Command No.	33
Command Mode	Polling
Command Format	Normal
Cmd In Size	26
Cmd Out Size	4
Cmd In Address	0
Cmd Out Address	0
Cmd In Offset	0

Fig 28-1: Add the first HART command 33

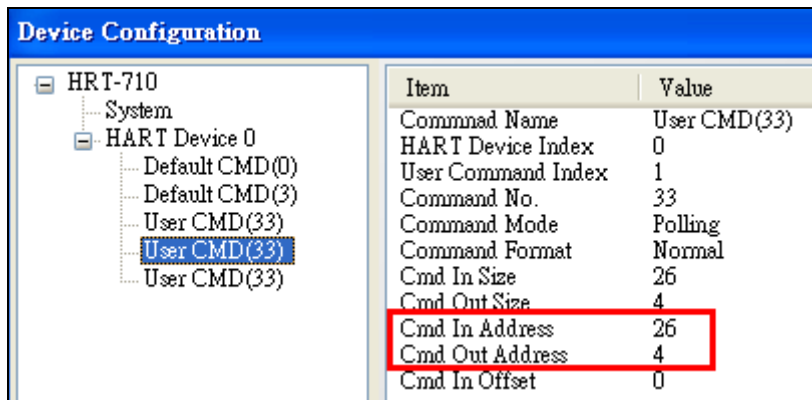

The screenshot shows the 'Device Configuration' window for HRT-710. The left pane shows a tree view with 'HART Device 0' expanded, and 'User CMD(33)' selected. The right pane shows the configuration for this command:

Item	Value
Commnad Name	User CMD(33)
HART Device Index	0
User Command Index	1
Command No.	33
Command Mode	Polling
Command Format	Normal
Cmd In Size	26
Cmd Out Size	4
Cmd In Address	26
Cmd Out Address	4
Cmd In Offset	0

Fig 28-2: Add the second HART command 33

Device Configuration																									
<ul style="list-style-type: none"> [-] HRT-710 <ul style="list-style-type: none"> System <ul style="list-style-type: none"> [-] HART Device 0 <ul style="list-style-type: none"> Default CMD(0) Default CMD(3) User CMD(33) User CMD(33) User CMD(33) 	<table border="1"> <thead> <tr> <th>Item</th> <th>Value</th> </tr> </thead> <tbody> <tr><td>Commnad Name</td><td>User CMD(33)</td></tr> <tr><td>HART Device Index</td><td>0</td></tr> <tr><td>User Command Index</td><td>2</td></tr> <tr><td>Command No.</td><td>33</td></tr> <tr><td>Command Mode</td><td>Polling</td></tr> <tr><td>Command Format</td><td>Normal</td></tr> <tr><td>Cmd In Size</td><td>26</td></tr> <tr><td>Cmd Out Size</td><td>4</td></tr> <tr><td>Cmd In Address</td><td>52</td></tr> <tr><td>Cmd Out Address</td><td>8</td></tr> <tr><td>Cmd In Offset</td><td>0</td></tr> </tbody> </table>	Item	Value	Commnad Name	User CMD(33)	HART Device Index	0	User Command Index	2	Command No.	33	Command Mode	Polling	Command Format	Normal	Cmd In Size	26	Cmd Out Size	4	Cmd In Address	52	Cmd Out Address	8	Cmd In Offset	0
Item	Value																								
Commnad Name	User CMD(33)																								
HART Device Index	0																								
User Command Index	2																								
Command No.	33																								
Command Mode	Polling																								
Command Format	Normal																								
Cmd In Size	26																								
Cmd Out Size	4																								
Cmd In Address	52																								
Cmd Out Address	8																								
Cmd In Offset	0																								

Fig 28-3: Add the third HART command 33

3. Open the "Default Output Data" page.

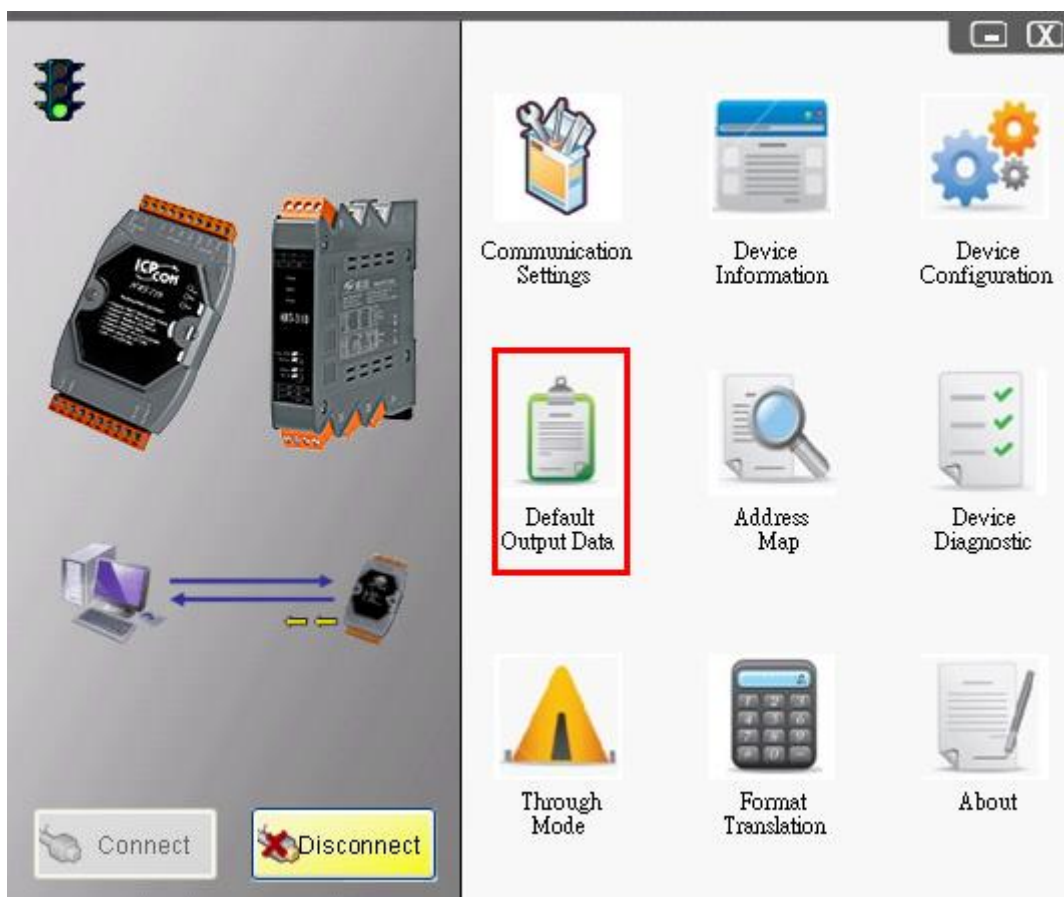

Fig 28-4: Click the "Default Output Data" item

4. Set the request data of these three HART command 33.

[1] The first UserCMD(33) – Red: 4 bytes are all 0.

[2] The second UserCMD(33) – Pink: The first byte is 1 and the others are all 0.

[3] The third UserCMD(33) – Blue: The first byte is 2 and the others are all 0.

=> After finish, click the "Save to Device" button.

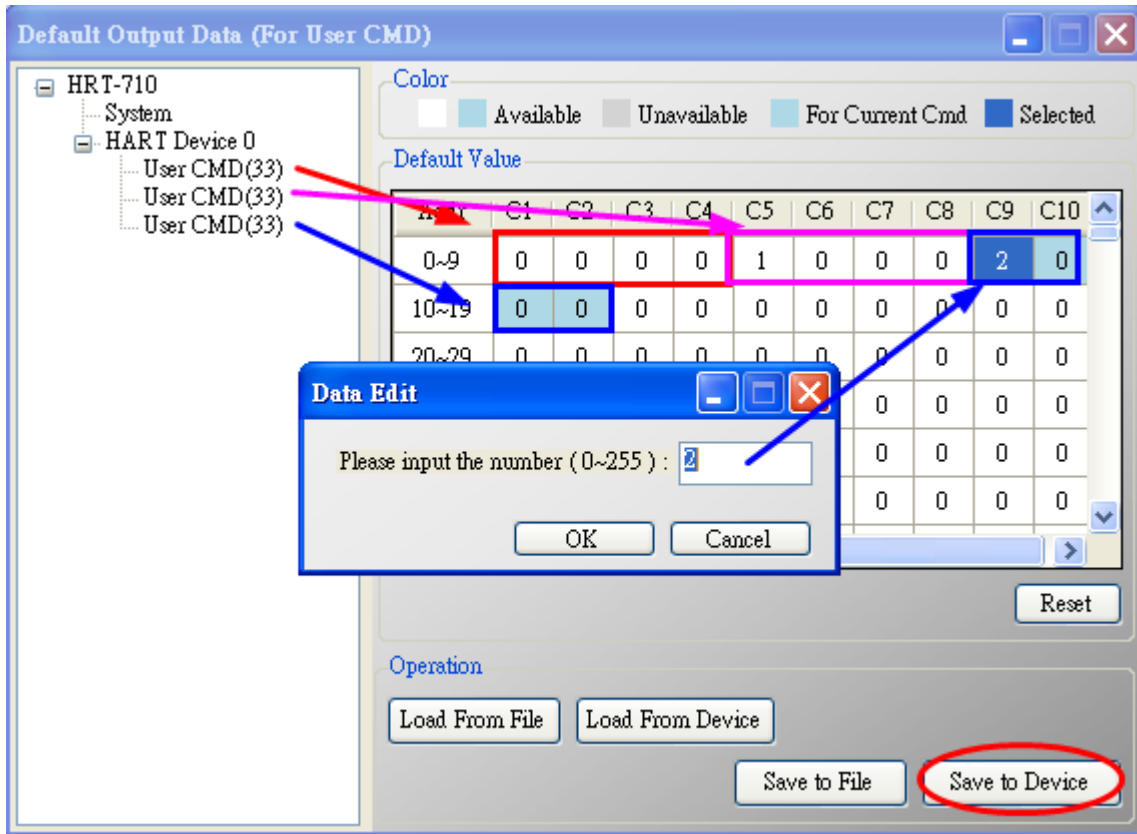
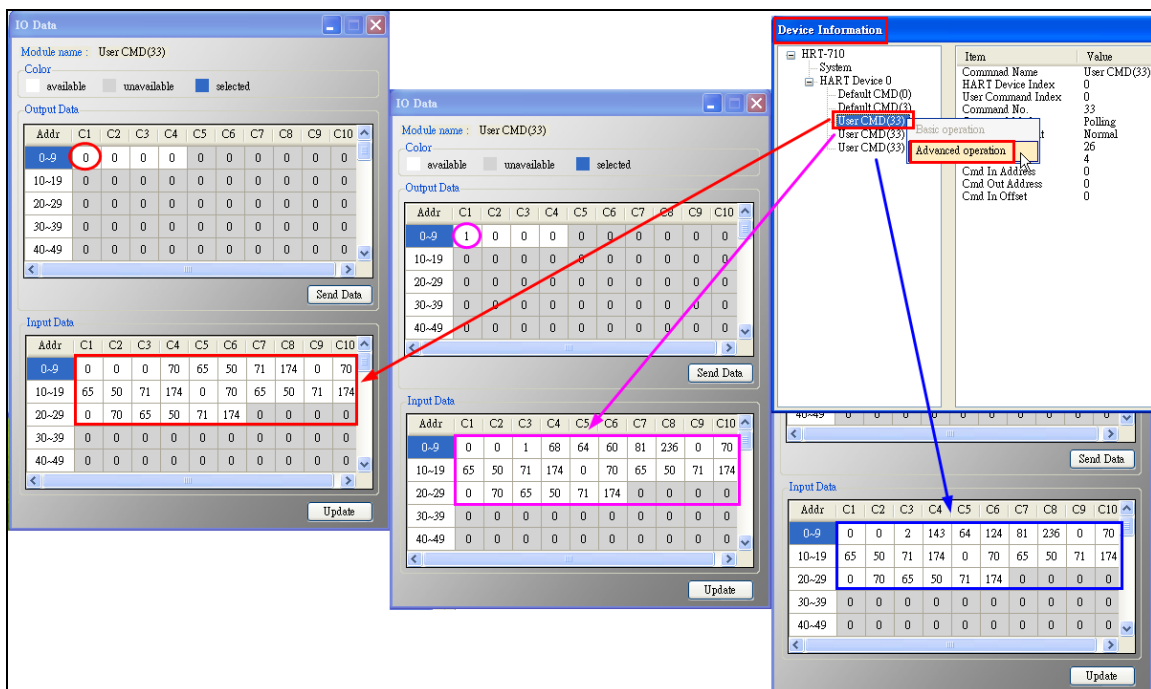

Fig 28-5: Set the “Request Data” of these three HART command 33

5. When HRT-710/310 receives HART request command 33, it will compare the “Request Data” value and if match, it will save HART response command 33 data to the correct Modbus address. (If no match, it will ignore the HART command 33 data)

[1] In the “Device Information” page, open the “Advanced operation” of UserCMD(33).



[2] Using "Modscan" software to get these three HART command 33 data.
 (The data format in Modscan is hex and in "IO Data" page is decimal.)

ModScan32 - [ModScan]

File Connection Setup View Window Help

Address: 0001 Device ID: MODBUS
 Length: 39 04: INPUT RE

30001: <0046H> 30021: <4132H>
 30002: <0000H> 30022: <0046H>
 30003: <47AEH> 30023: <0046H>
 30004: <4132H> 30024: <47AEH>
 30005: <4132H> 30025: <47AEH>
 30006: <0046H> 30026: <4132H>
 30007: <0046H> 30027: <U28FH>
 30008: <47AEH> 30028: <0000H>
 30009: <47AEH> 30029: <51ECH>
 30010: <4132H> 30030: <407CH>
 30011: <4132H> 30031: <4132H>
 30012: <0046H> 30032: <0046H>
 30013: <0000H> 30033: <0046H>
 30014: <47AEH> 30034: <47AEH>
 30015: <403CH> 30035: <47AEH>
 30016: <0144H> 30036: <4132H>
 30017: <0046H> 30037: <4132H>
 30018: <51ECH> 30038: <0046H>
 30019: <47AEH> 30039: <47AEH>
 30020: <4132H>

IO Data

Module name: UserCMD(33)

Color: available unavailable selected

Output Data

Addr	C1	C2	C3	C4	C5	C6	C7	C8	C9	C10
0~9	0	0	0	0	0	0	0	0	0	0
10~19	0	0	0	0	0	0	0	0	0	0
20~29	0	0	0	0	0	0	0	0	0	0
30~39	0	0	0	0	0	0	0	0	0	0
40~49	0	0	0	0	0	0	0	0	0	0

Send Data

Input Data

Addr	C1	C2	C3	C4	C5	C6	C7	C8	C9	C10
0~9	0	0	0	70	65	50	71	174	0	70
10~19	65	50	71	174	0	70	65	50	71	174
20~29	0	70	65	50	71	174	0	0	0	0
30~39	0	0	0	0	0	0	0	0	0	0
40~49	0	0	0	0	0	0	0	0	0	0

Update

IO Data

Module name: UserCMD(33)

Color: available unavailable selected

Output Data

Addr	C1	C2	C3	C4	C5	C6	C7	C8	C9	C10
0~9	1	0	0	0	0	0	0	0	0	0
10~19	0	0	0	0	0	0	0	0	0	0
20~29	0	0	0	0	0	0	0	0	0	0
30~39	0	0	0	0	0	0	0	0	0	0
40~49	0	0	0	0	0	0	0	0	0	0

Send Data

Input Data

Addr	C1	C2	C3	C4	C5	C6	C7	C8	C9	C10
0~9	0	0	1	68	64	60	81	236	0	70
10~19	65	50	71	174	0	70	65	50	71	174
20~29	0	70	65	50	71	174	0	0	0	0
30~39	0	0	0	0	0	0	0	0	0	0
40~49	0	0	0	0	0	0	0	0	0	0

IO Data

Module name: UserCMD(33)

Color: available unavailable selected

Output Data

Addr	C1	C2	C3	C4	C5	C6	C7	C8	C9	C10
0~9	2	0	0	0	0	0	0	0	0	0
10~19	0	0	0	0	0	0	0	0	0	0
20~29	0	0	0	0	0	0	0	0	0	0
30~39	0	0	0	0	0	0	0	0	0	0
40~49	0	0	0	0	0	0	0	0	0	0

Send Data

Input Data

Addr	C1	C2	C3	C4	C5	C6	C7	C8	C9	C10
0~9	0	0	2	143	64	124	81	236	0	70
10~19	65	50	71	174	0	70	65	50	71	174
20~29	0	70	65	50	71	174	0	0	0	0
30~39	0	0	0	0	0	0	0	0	0	0
40~49	0	0	0	0	0	0	0	0	0	0

Q30 : How to get HART command 9 information ?

A30: (2023/10/11)

- 1. The request data format of HART command 9 is as Figure 30-1.

Request data bytes		
Byte	Format	Description
0	Unsigned-8	Slot 0: Device variable code
1	Unsigned-8	Slot 1: Device variable code (optional)
2	Unsigned-8	Slot 2: Device variable code (optional)
3	Unsigned-8	Slot 3: Device variable code (optional)
4	Unsigned-8	Slot 4: Device variable code (optional)
5	Unsigned-8	Slot 5: Device variable code (optional)
6	Unsigned-8	Slot 6: Device variable code (optional)
7	Unsigned-8	Slot 7: Device variable code (optional)

Figure 30-1

- 2. The response data format of HART command 9 is as Figure 30-2.

Response data bytes		
Byte	Format	Description
0	Unsigned-8	Extended device status
1	Unsigned-8	Slot 0: Device variable code
2	Unsigned-8	Slot 0: Device variable classification
3	Unsigned-8	Slot 0: Device variable unit
4..7	Float	Slot 0: Device variable value
8	Unsigned-8	Slot 0: Device variable status
9	Unsigned-8	Slot 1: Device variable code
10	Unsigned-8	Slot 1: Device variable classification
11	Unsigned-8	Slot 1: Device variable unit
12..15	Float	Slot 1: Device variable value
16	Unsigned-8	Slot 1: Device variable status
17	Unsigned-8	Slot 2: Device variable code
18	Unsigned-8	Slot 2: Device variable classification
19	Unsigned-8	Slot 2: Device variable unit
20..23	Float	Slot 2: Device variable value
24	Unsigned-8	Slot 2: Device variable status
25	Unsigned-8	Slot 3: Device variable code
26	Unsigned-8	Slot 3: Device variable classification
27	Unsigned-8	Slot 3: Device variable unit
28..31	Float	Slot 3: Device variable value
32	Unsigned-8	Slot 3: Device variable status
33	Unsigned-8	Slot 4: Device variable code
34	Unsigned-8	Slot 4: Device variable classification
35	Unsigned-8	Slot 4: Device variable unit
36..39	Float	Slot 4: Device variable value
40	Unsigned-8	Slot 4: Device variable status
41	Unsigned-8	Slot 5: Device variable code
42	Unsigned-8	Slot 5: Device variable classification
43	Unsigned-8	Slot 5: Device variable unit
44..47	Float	Slot 5: Device variable value
48	Unsigned-8	Slot 5: Device variable status
49	Unsigned-8	Slot 6: Device variable code
50	Unsigned-8	Slot 6: Device variable classification
51	Unsigned-8	Slot 6: Device variable unit
52..55	Float	Slot 6: Device variable value
56	Unsigned-8	Slot 6: Device variable status
57	Unsigned-8	Slot 7: Device variable code
58	Unsigned-8	Slot 7: Device variable classification
59	Unsigned-8	Slot 7: Device variable unit
60..63	Float	Slot 7: Device variable value
64	Unsigned-8	Slot 7: Device variable status
65..68(*)	Time	Slot 0: Data time stamp

(*) Timestamp is always present, even if less than 8 device variables were requested. Its position is always at the end of the frame. Timestamp is in format 1/32 ms since midnight (Unsigned-32).

Changes from Revision 6.1 to Revision 7.0
 Added time stamp to Command 9

Figure 30-2

[1] When the request data length is **1**, the response data length will be **13**. The response data format will be “Extended device status (1B)” + “Slot 0 Data (8B)” + “Time stamp (4B)”.

[2] When the request data length is **2**, the response data length will be **21**. The response data format will be “Extended device status (1B)” + “Slot 0 Data (8B)” + “Slot 1 Data (8B)” + “Time stamp (4B)”.

...

[8] When the request data length is **8**, the response data length will be **69**. The response data format will be “Extended device status (1B)” + “Slot 0~7 Data (64B)” + “Time stamp (4B)”.

=> If HART command version of HART device is lower than v7.0, then the time stamp (4B) of the response data should be removed.

3. The below example adopts that HART command version of HART device is v7.0 and the request data length is 2 for HART command 9. So the response data length will be 21.

[1] In the HG_Tool, add command number 9. The “In Size” and “Out Size” fields fill in 23 and 2 (The data length of the “In Size” field should include the response code (2B) like Figure 30-4.)

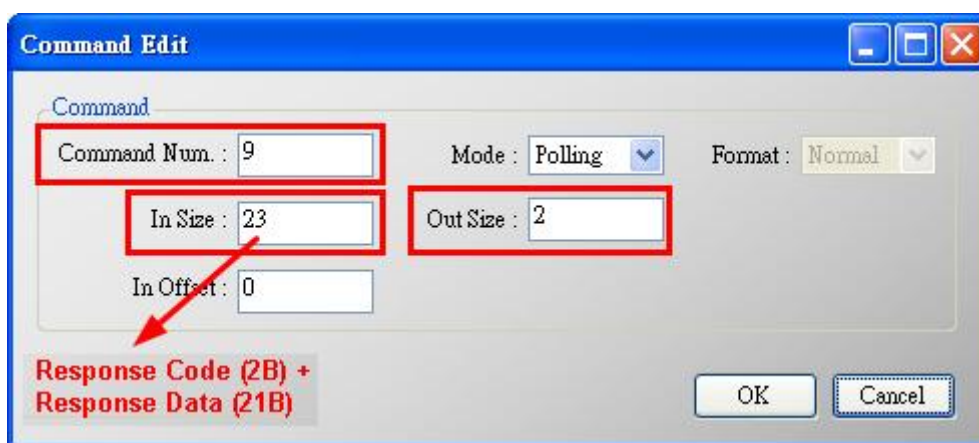

Figure 30-4

[2] Click the “Save to Device” button to save the settings to HRT-710 like Figure 30-5.

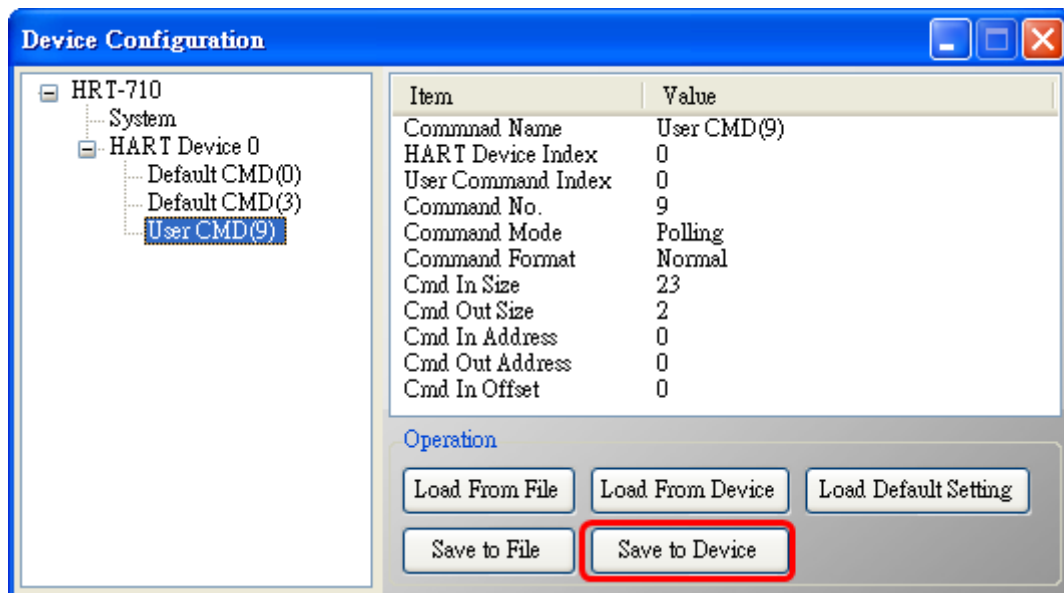
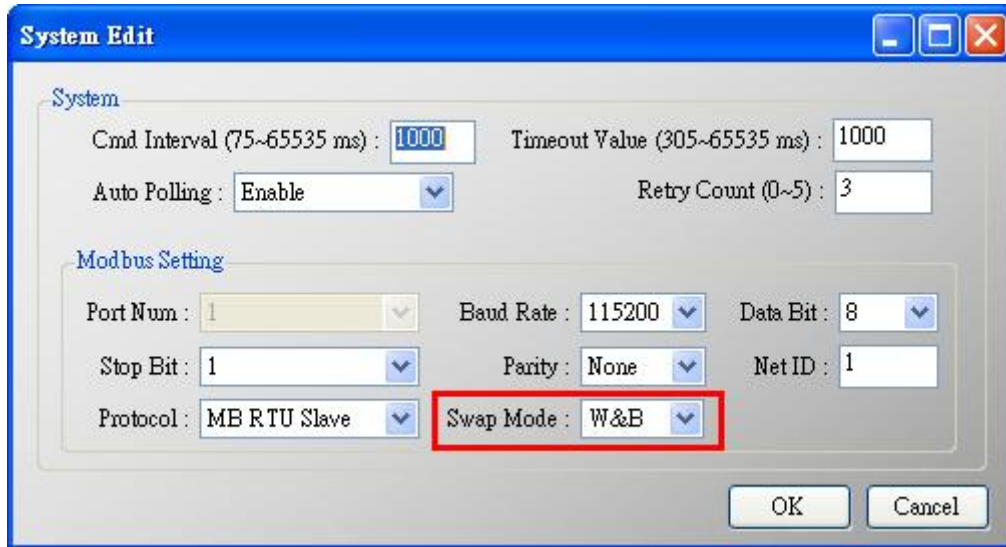

Figure 30-5

[3] In the “Device Information” of HG_Tool, right click the “User CMD9” and choose the “Advanced operation” option (like Figure 30-6) to show the received data of CMD9 (like Figure 30-7).

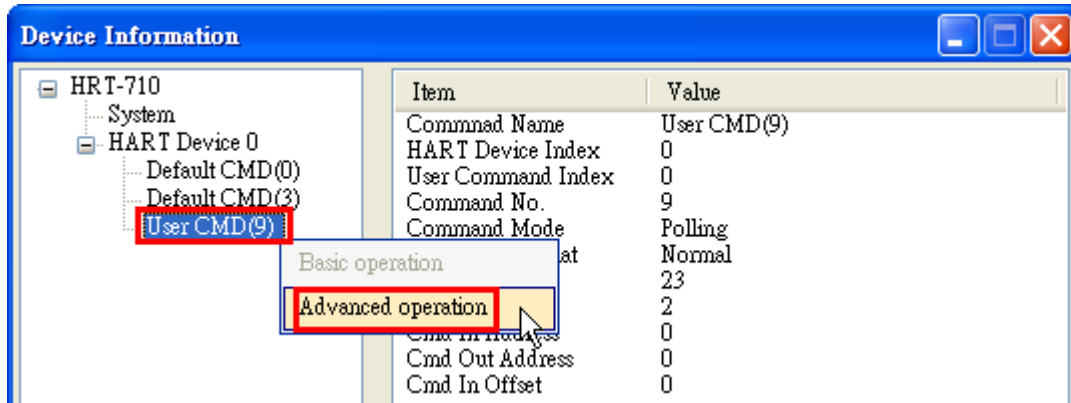

Figure 30-6

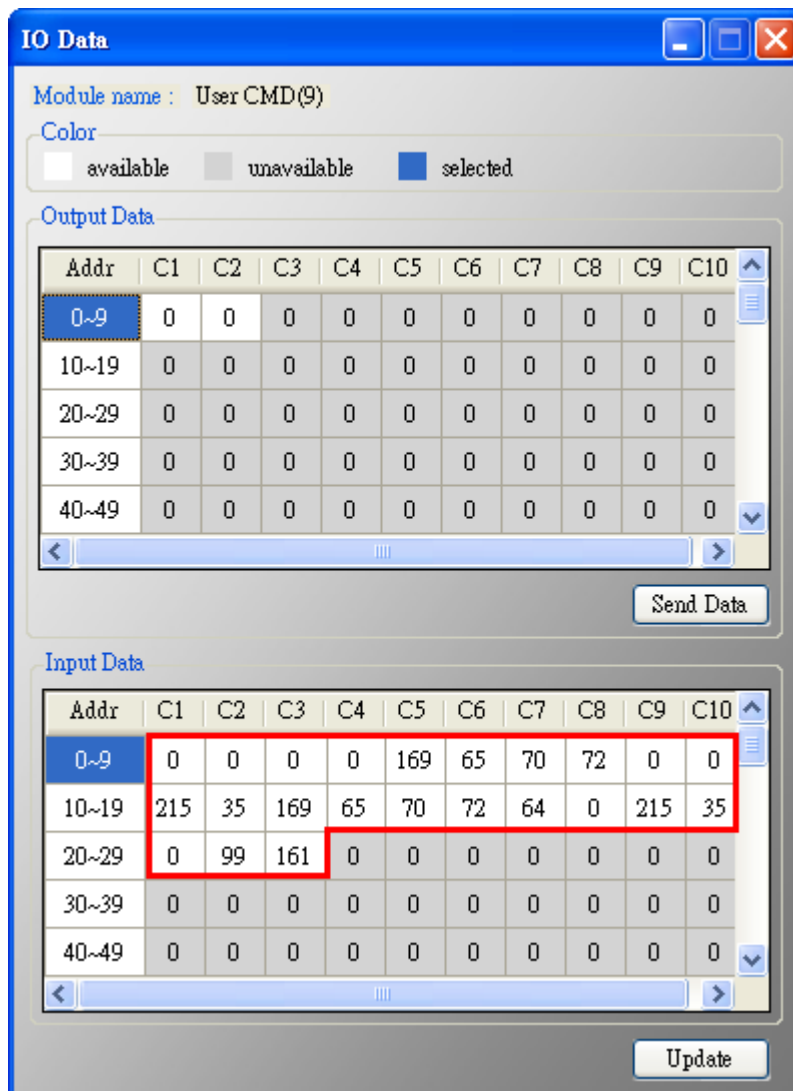

Figure 30-7

[4] In Figure 30-8, using HART converter (like I-7567) with HC_Tool software to read HART command 9 data of HART device. The data will be the same with Figure 30-7 except the data of Time Stamp.

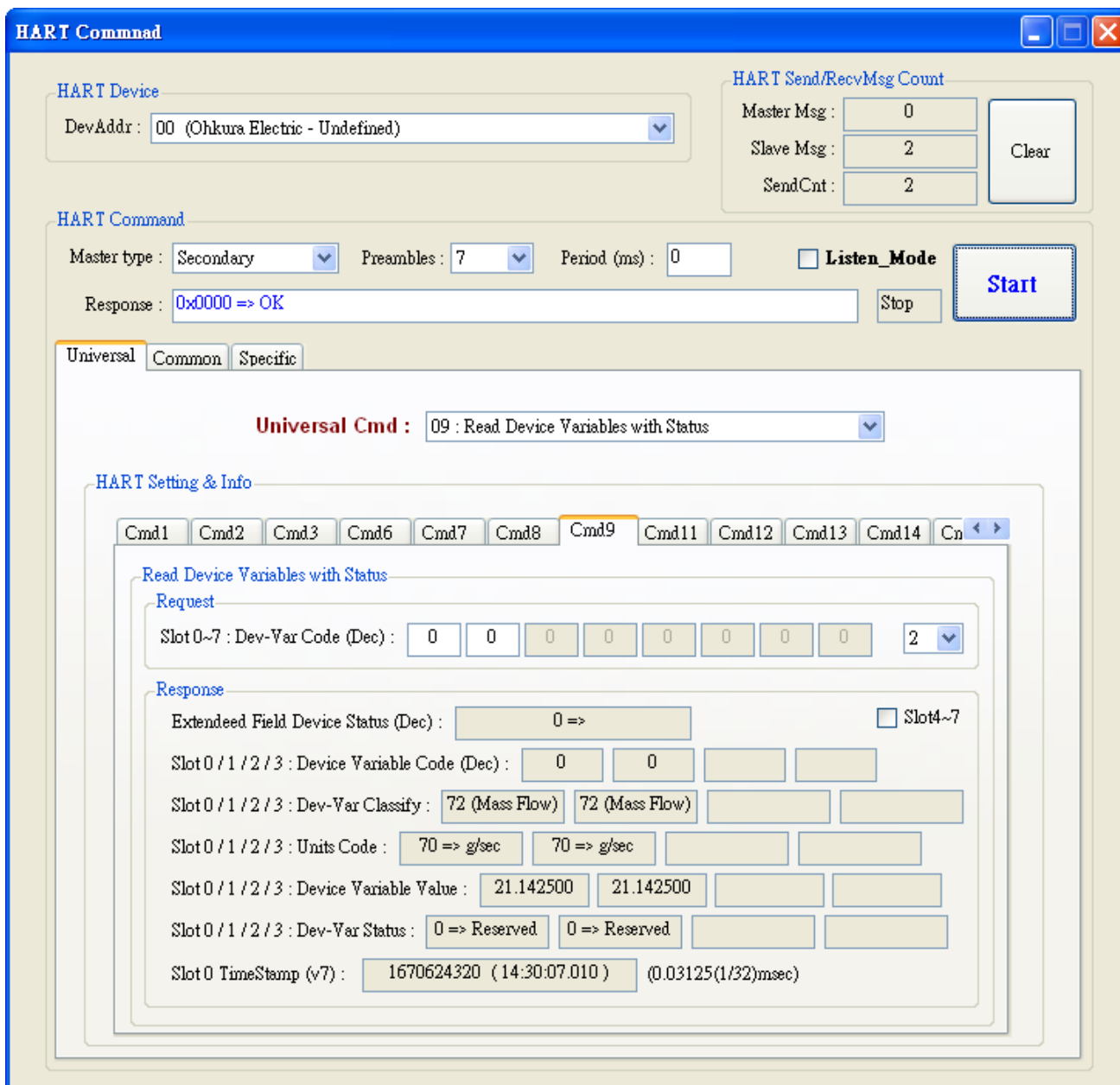

Figure 30-8

[5] Get HART command 9 data via Modbus communication:

<1> In the "Address Map" screen, click the "UserCMD(9)" item. In the "Modbus AI" area, the blue grid will be the address of the received data of UserCMD(9) like Figure 30-9. In the example, it needs 23 bytes (response code (2B) + response data (21B)) for HART command 9. Therefore, it will occupy 12 modbus address from 0 to 11.

<2> In Figure 30-10, they are the Modbus data received from address 0~11 (30001~30012) by using Modscan software.

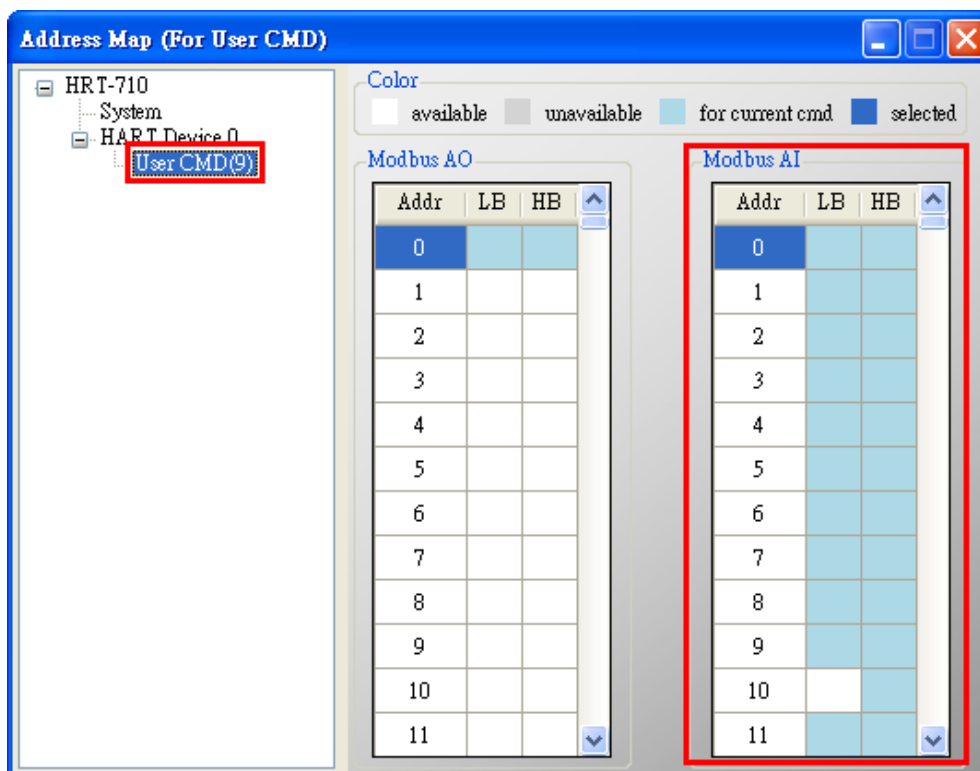

Figure 30-9

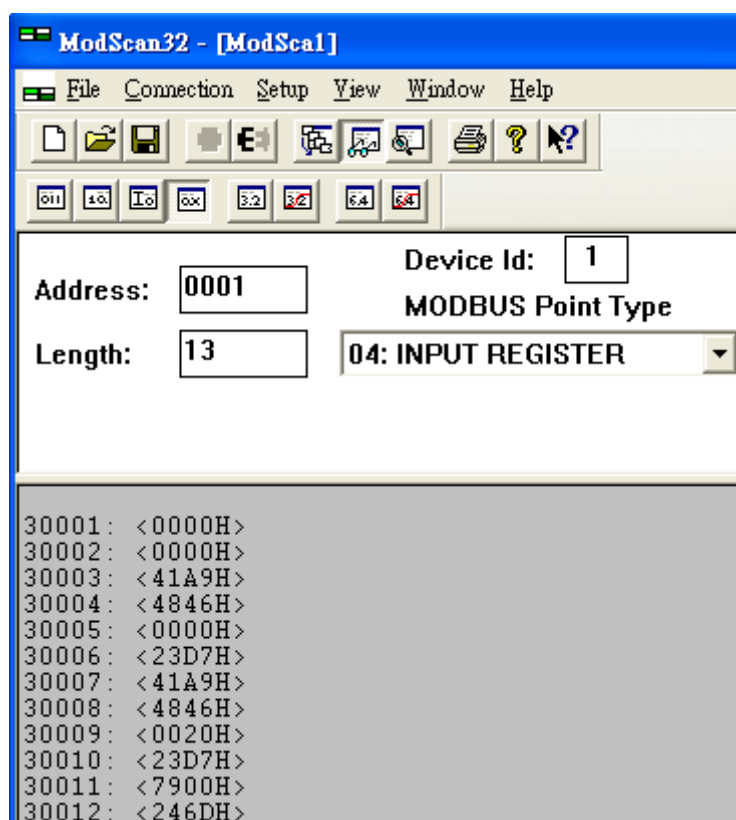

Figure 30-10

Q31 : Integrate HART device with burst mode ?

A31: (2024/03/07)

[Example]

[1] A user wants to get two HART device data.

- <1> One HART device works in the burst mode.
- <2> Another HART device works in the send/receive mode.

[Note]

[1] Need to know the **long frame address** and **which HART command** sent by HART device in the **burst mode**.

[Solution]

1. Set these two short address of HART devices to be 1 and 2.

- [1] The long address of **HART device 1** is **0x1A 0B 50 EB CD** and the **burst mode** command no. is command 3.
- [2] The **HART device 2** is in the **send/receive mode**.

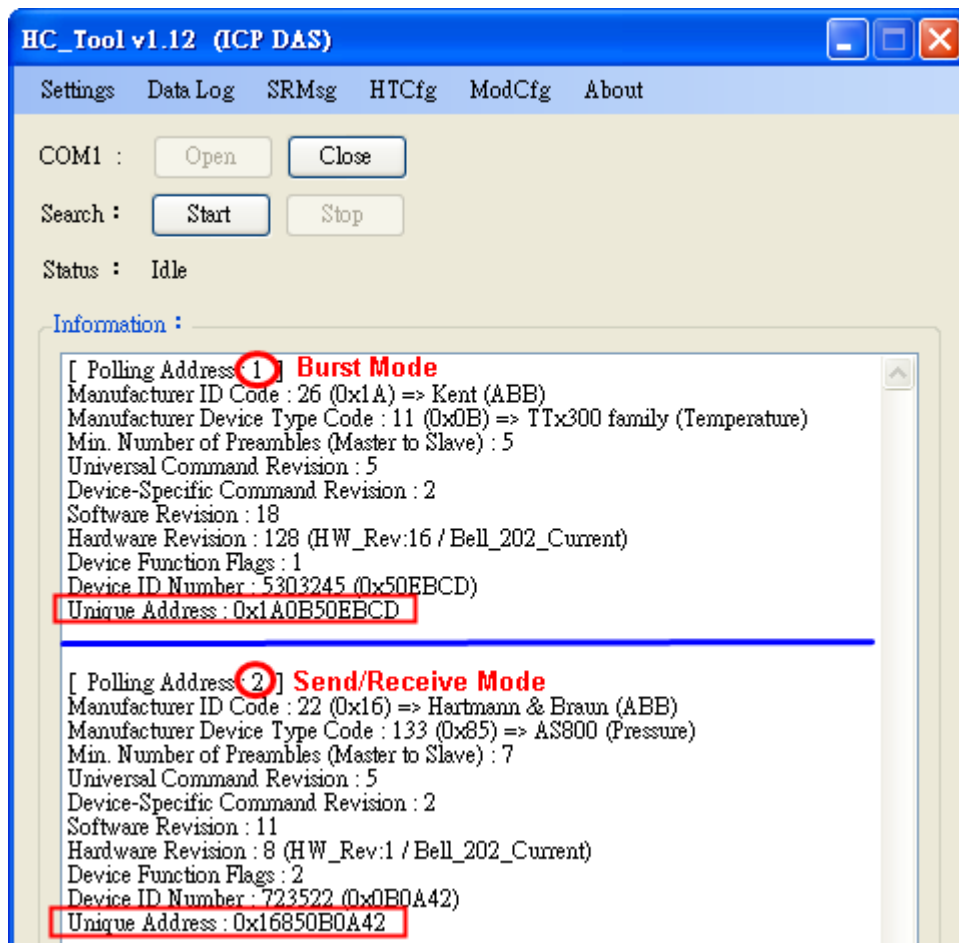

Fig 31-1 Two HART devices information

2. Add these two HART devices with address 1 and 2 to HRT-7(3)10.

(1) In the "Module Edit" page, add these two HART devices.

The screenshot shows the "Module Edit" dialog box. The "Easy Mode" checkbox is unchecked. Under the "Module" section, "HART Ch." is set to 0, "Auto Configure" is Disable, and "Frame Type" is Long. "Master Type" is Primary Master, "Network Mode" is Multidrop, and "Address" is 1. "Preambles" is 5, "Cmd 0 Mode" is Initial, and "Cmd 3 Mode" is Initial. Under the "Unique Identifier" section, "Auto Get Unique ID" is unchecked. The "Manufacturer ID" is 26, "Device Type" is 11, and "Device ID" is 5303245. The values 0x1A, 0x0B, and 0x50EB CD are displayed in red above the respective fields. "OK" and "Cancel" buttons are at the bottom right.

Fig 31-2 Add HART device with address 1 (0x1A 0B 50 EB CD) (Burst Mode)

The screenshot shows the "Module Edit" dialog box. The "Easy Mode" checkbox is unchecked. Under the "Module" section, "HART Ch." is set to 0, "Auto Configure" is Disable, and "Frame Type" is Long. "Master Type" is Primary Master, "Network Mode" is Multidrop, and "Address" is 2. "Preambles" is 5, "Cmd 0 Mode" is Initial, and "Cmd 3 Mode" is Polling. Under the "Unique Identifier" section, "Auto Get Unique ID" is checked. The "Manufacturer ID" is 22, "Device Type" is 133, and "Device ID" is 723522. "OK" and "Cancel" buttons are at the bottom right.

Fig 31-3 Add HART device with address 2

(2) In the "System Edit" page, set the "Swap Mode" to be "W&B".

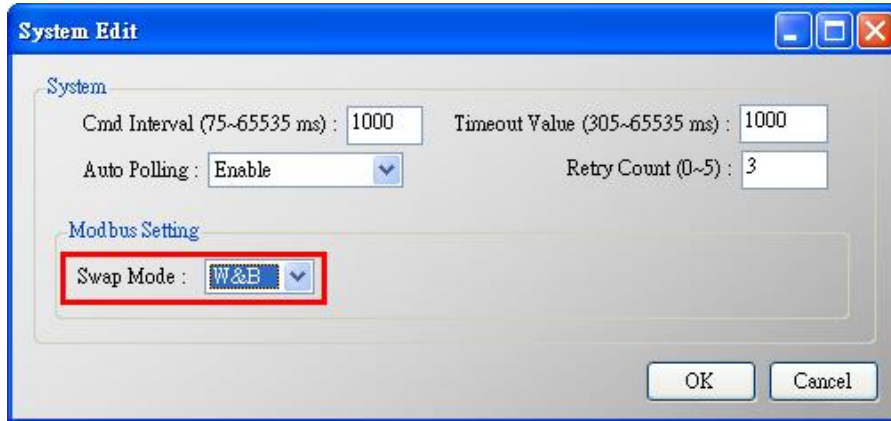

Fig 31-4 Set "Swap Mode" to "W&B".

(3) After finished the settings, in "Device Configuration" page, click "Save to Device" button to save all the settings to HRT-7(3)10.

3. Get these two HART device data.

(1) Get HART command 3 data of these two HART devices by using HG_Tool.

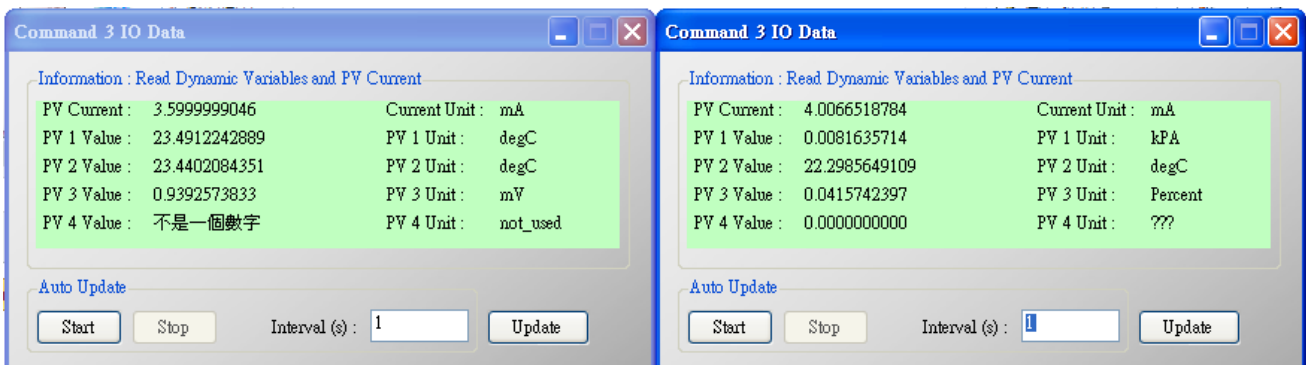

Fig 31-5 Command 3 data in HG_Tool

(2) Get HART command 3 data of these two HART devices by using Modscan software.
(HART command 3 data are all the same in HG_Tool and Modscan.)

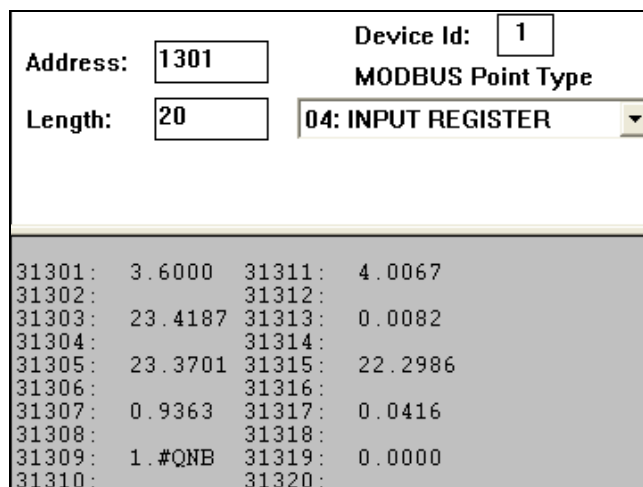

Fig 31-6 Command 3 data in Modscan software

Appendix A. HART Command

The often HART universal commands are listed as below.

Command 0: Read Unique Identifier

Request data bytes: none

Response data bytes: $2+12 = 14$

Index	Format	Description
Byte 0	uint8	Response code 1
Byte 1	uint8	Response code 2
Byte 2	uint8	254
Byte 3	uint8	Manufacturer ID
Byte 4	uint8	Manufacturer' s device ID
Byte 5	uint8	Number of preambles needed in the request
Byte 6	uint8	Command set revision number
Byte 7	uint8	Transmitter specific revision code
Byte 8	uint8	Software revision
Byte 9	uint8	Hardware revision
Byte 10	uint8	Flags
Byte 11~13	uint24	Device ID number (MSB first)

Command 1: Read Primary Variable

Request data bytes: none

Response data bytes: $2+5 = 7$

Index	Format	Description
Byte 0	uint8	Response code 1
Byte 1	uint8	Response code 2
Byte 2	uint8	Unit code
Byte 3~6	float	Primary Variable

Command 2: Read P.V. Current and Percentage of Range

Request data bytes: none

Response data bytes: $2+8 = 10$

Index	Format	Description
Byte 0	uint8	Response code 1
Byte 1	uint8	Response code 2
Byte 2~5	float	Primary Variable Current
Byte 6~9	float	Primary Variable Percentage of Range

Command 3: Read Dynamic Variables and P.V. Current

Request data bytes: none

Response data bytes: $2+24 = 26$

Index	Format	Description
Byte 0	uint8	Response code 1
Byte 1	uint8	Response code 2
Byte 2~5	float	Primary Variable Current
Byte 6	uint8	Primary Variable Unit code
Byte 7~10	float	Primary Variable
Byte 11	uint8	Secondary Variable Unit code
Byte 12~15	float	Secondary Variable
Byte 16	uint8	Tertiary Variable Unit code
Byte 17~20	float	Tertiary Variable
Byte 21	uint8	4th Variable Unit code
Byte 22~25	float	4th Variable

Command 6: Write Polling Address

Request data bytes: 1

Index	Format	Description
Byte 0	uint8	Polling Address

Response data bytes: $2+1 = 3$

Index	Format	Description
Byte 0	uint8	Response code 1
Byte 1	uint8	Response code 2
Byte 2	uint8	Polling Address

Command 11: Read Unique Identifier Associated with TAG

Request data bytes: 6

Index	Format	Description
Byte 0~5	PA6	TAG Name

Response data bytes: 2+12 = 14

Index	Format	Description
Byte 0	uint8	Response code 1
Byte 1	uint8	Response code 2
Byte 2	uint8	254
Byte 3	uint8	Manufacturer ID
Byte 4	uint8	Manufacturer's device ID
Byte 5	uint8	Number of preambles needed in the request
Byte 6	uint8	Command set revision number
Byte 7	uint8	Transmitter specific revision code
Byte 8	uint8	Software revision
Byte 9	uint8	Hardware revision
Byte 10	uint8	Flags
Byte 11~13	uint24	Device ID number (MSB first)

Command 12: Read Message

Request data bytes: none

Response data bytes: 2+24 = 26

Index	Format	Description
Byte 0	uint8	Response code 1
Byte 1	uint8	Response code 2
Byte 2~25	PA24	Message

Command 13: Read Tag, Descriptor, Date

Request data bytes: none

Response data bytes: 2+21 = 23

Index	Format	Description
Byte 0	uint8	Response code 1
Byte 1	uint8	Response code 2
Byte 2~7	PA6	TAG Name
Byte 8~19	PA12	Descriptor
Byte 20	uint8	Day of month
Byte 21	uint8	Month of year
Byte 22	uint8	Year as offset to 1900

Command 14: Read Primary Variable Sensor Information

Request data bytes: none

Response data bytes: 2+16 = 18

Index	Format	Description
Byte 0	uint8	Response code 1
Byte 1	uint8	Response code 2
Byte 2~4	uint24	Sensor Serial Number (MSB first)
Byte 5	uint8	Sensor limits unit
Byte 6~9	float	Upper sensor limit
Byte 10~13	float	Lower sensor limit
Byte 14~17	float	Minimum span

Command 15: Read Primary Variable Output Information

Request data bytes: none

Response data bytes: 2+17 = 19

Index	Format	Description
Byte 0	uint8	Response code 1
Byte 1	uint8	Response code 2
Byte 2	uint8	Alarm select code
Byte 3	uint8	Transfer function code
Byte 4	uint8	PV range value unit code
Byte 5~8	float	Upper range value
Byte 9~12	float	Lower range value

Index	Format	Description
Byte 13~16	float	Damping value
Byte 17	uint8	Write protect code
Byte 18	uint8	Private label distribution code

Command 16: Read Final Assembly Number

Request data bytes: none

Response data bytes: 2+3 = 5

Index	Format	Description
Byte 0	uint8	Response code 1
Byte 1	uint8	Response code 2
Byte 2~4	uint24	Final assembly number (MSB first)

Command 17: Write Message

Request data bytes: 24

Index	Format	Description
Byte 0~23	PA24	Message

Response data bytes: 2+24 = 26

Index	Format	Description
Byte 0	uint8	Response code 1
Byte 1	uint8	Response code 2
Byte 2~25	PA24	Message

Command 18: Write Tag, Descriptor, Date

Request data bytes: 21

Index	Format	Description
Byte 0~5	PA6	TAG Name
Byte 6~17	PA12	Descriptor
Byte 18	uint8	Day of month
Byte 19	uint8	Month of year
Byte 20	uint8	Year as offset to 1900

Response data bytes: 2+21 = 23

Index	Format	Description
Byte 0	uint8	Response code 1
Byte 1	uint8	Response code 2

Index	Format	Description
Byte 2~7	PA6	TAG Name
Byte 8~19	PA12	Descriptor
Byte 20	uint8	Day of month
Byte 21	uint8	Month of year
Byte 22	uint8	Year as offset to 1900

Command 19: Write Final Assembly Number

Request data bytes: 3

Index	Format	Description
Byte 0~2	uint24	Final assembly number (MSB first)

Response data bytes: 2+3 = 5

Index	Format	Description
Byte 0	uint8	Response code 1
Byte 1	uint8	Response code 2
Byte 2~4	uint24	Final assembly number (MSB first)

[Note]

Uint8	8-bit unsigned integer
Uint24	24-bit unsigned integer
Float	IEEE 754 format
PA6	Packed-ASCII 6 octets = 8 characters
PA12	Packed-ASCII 12 octets = 16 characters
PA24	Packed-ASCII 24 octets = 32 characters

Appendix B. Command Format

The HART data format of MB address is divided into the “Normal” and “Simple” format.

1. Normal format :

When read / write HART data by Modbus, the MB data format is HART standard command format.

2. Simple format :

When read / write HART data by Modbus, the MB data format is simple format (omit the “Response Code” and “Unit” data). In this mode, the HMI or SCADA software can read or write HART data easily. Now, it only supports HART command number 1, 2 and 3.

The simple format of HART command is shown as below:

(1) Command 1: (Read Primary Variable)

Request data bytes: none

Response data bytes: 4

Index	Format	Description
Byte 0~3	float	Primary Variable

(2) Command 2: (Read P.V. Current and Percentage of Range)

Request data bytes: none

Response data bytes: 8

Index	Format	Description
Byte 0~3	float	Primary Variable Current
Byte 4~7	float	Primary Variable Percentage of Range

(3) Command 3: (Read Dynamic Variables and P.V. Current)

Request data bytes: none

Response data bytes: 20

Index	Format	Description
Byte 0~3	float	Primary Variable Current
Byte 4~7	float	Primary Variable
Byte 8~11	float	Secondary Variable
Byte 12~15	float	Tertiary Variable
Byte 16~19	float	4th Variable

Appendix C: Version History

Ver.	Author	Date	Description
1.00	Raiden	2010/07/08	1. First Version
1.10	Raiden	2011/10/24	1. FW update to v1.2: [1]Add FW update via Com Port
1.20	Raiden	2012/03/06	1. FW update to v1.3 [1]Add “Simple Format” function
1.23	Edward	2012/12/04	1. Modify the product name to HRT-710. 2. FW update to v1.5: [1]Add on-line replacement of HART devices. [2]Add Long Frame Address acquisition automatically. [3]Add new MB_Addr:1300~1459 (The simple format of Default CMD(3)) 3. HG_Tool update to v1.3
1.24	Edward	2015/06/16	1. Add the “FAQ” chapter
1.25	Edward	2015/12/23	1. Add the Q13~15 of “FAQ” .
1.30	Edward	2016/08/31	1. Add the Q16 of “FAQ” . 2. Add the description of HRT-310.
1.31	Peter	2017/5/11	1. Add Modbus starting address explanation to FAQ Q03
1.32	Peter	2017/12/20	1. Add FAQ Q18, Q19
1.33	Peter	2018/04/10	1.Add FAQ Q20
1.34	Peter	2018/05/22	1.Modify FAQ Q15, 18, 19 with Modbus command FC06
1.35	Peter	2018/10/29	1. Modify FAQ Q16 with additional 4G contents 2. Add FAQ Q21 3. Add FAQ Q22 4. Add FAQ Q23
1.36	Peter	2019/02/23	1. Add FAQ Q24 / Q25
1.37	Edward	2020/08/19	1.Add Fig 2.3.4-4 2.Add FAQ Q26 3.Add the “In Offset” field in the UserCMD setting.
1.38	Edward	2022/04/19	1.Update Q22 2.Removal of Q25 misspellings 3.Update Q04 (Add the “RevB”)
1.39	Edward	2022/06/15	1.Exchange the function description of the output data Modbus Address 0x1F4 and 0x1F5.

1.40	Edward	2024/03/07	1.Add the description of FAQ Q04, Q23. 2.Add FAQ Q28~31
------	--------	------------	--