



# Full Product Catalog

## 2018 - 2019





# Automation T

## Machine Automation



Motionnet Solutions



ET-M8194H

Motion Card

## Energy Solutions



PMC

PM-3133/PM-3133-MTCP



Current Sensor Voltage Attenuator

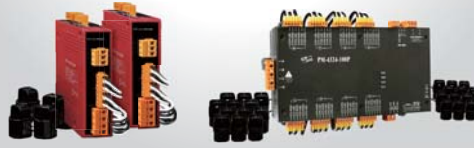

PM-3112/PM-3114

PM-4324

## IoT Solutions



UA-5200



WISE-7500



WISE-7000



DL Series



MiniOS7



Linux



IoTstar



ISaGRAF/Win-GRAF



HMIWorks



RTU Center



NAPOPC



InduSoft

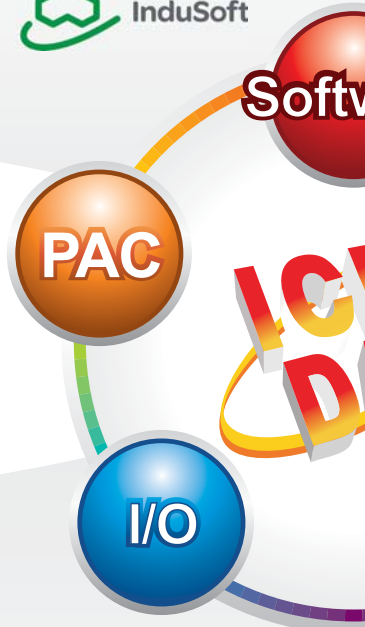

Multi-Port Serial Card



PDS/DS/tDS



Switch

## EXPANSION



RU-87Pn

ET-87Pn



iDCS-8830



PROFIBUS

CAN



I-8K/I-87K



X-board



XW-board  
XV-board



RS-485/RS-422/  
RS-232



# otal Solutions



WISE-5800  
MQ-7200 PIR/RPIR Series  
ICAM series

## M2M



SMS series (GT-500 series) RTU series (GT-540/G-4500) GRP series (GRP-500 series)  
G-4500 series GTM-20x series RMV series (M2M-700 series)

## Building Automation



HMI & ViewPAC (SV-2201-CE7/VP-25W1/VP-4131)  
Tiny I/O Series  
IR-310-RM  
LC series  
TouchPAD

## ware



Microsoft Windows Embedded  
Microsoft Windows CE  
UniDAQ  
VxComm  
Visual Studio.NET  
WISE  
VCE  
eLogger  
EzDataLogger  
SMS\_DB

## PC Card



PO-104  
ISA  
PCI  
PCI EXPRESS

## Communication



Gateway Converter RF GSM/GPRS ZigBee Wi-Fi

## WIRED



Ethernet CAN PROFIBUS PROFINET USB EtherCAT BACnet EtherNet/IP HART WISE

## WIRELESS



3G/4G ZigBee (ZT Series) IR Wi-Fi



# ICP DAS

ICP DAS was established in 1993 and is strongly focused on innovation and the enhancement of industrial automation technology. ICP DAS continuously endeavors to develop a comprehensive selection of products ranging from remote I/O controllers, distributed I/O modules, I/O data acquisition boards, programmable automation controllers, industrial communication modules, web-related products, motion control systems, SCADA/HMI software to automation solutions for applications critical to energy management, motion automation, smart factories, intelligent buildings, and smart cities. Our ambition is to provide a wide range of high-quality products and versatile applications, together with prompt and efficient service, that can be implemented to assist in the continued success of our clients worldwide.



**Taiwan Headquarters & 1st Factory (Hsinchu)**

## **Our Intelligent Solutions and Comprehensive Service, Your Key to Success.**

The inevitable trend toward the implementation of the Internet of Things (IoT) and Industry 4.0 currently leads global cooperation and technology development, and the future demands and business opportunities in this area are potentially unlimited. We believe that one of the key success factors in the advancement of the automation industry is intelligence. Now, however, the evolution of the industry has entered into a phase of intelligent automation, ranging from a single domain with a limited scale to encompassing multiple domains on a significantly expanded scale. Consequently, ICP DAS has transformed itself from simply a hardware provider to a provider of total automation solutions and service integration. As a result, our role in this industry has also been constantly evolving.

When looking back on our past development, we have come to realize that ICP DAS has already been intrinsically involved in the world of IoT and Industry 4.0. The integrated solutions provided by ICP DAS are a combination of both tangible products and intangible services which cover a variety of integrated application services and industry-oriented fields, including:

- ▶ M2M /IOT
- ▶ Machine Automation
- ▶ Panel Solutions
- ▶ Energy Management
- ▶ Building Automation
- ▶ SCADA, InduSoft Solutions

In addition to our close cooperation with worldwide distributors, ICP DAS has forged strong partnerships with those clients who have domain knowledge. We integrate the expertise of our clients with our ability for customization to offer products and services in line with needs. ICP DAS helps our customers to achieve success and that is both our goal and our passion.

At ICP DAS, we are committed to leveraging our considerable experience, our highly professional R&D capabilities, and our innovative products, as well as our dedication to service, in order to work together with you to seize the unquestionable future business opportunities that will arise from the increasing adoption of both IoT and Industry 4.0.



**Taiwan 2nd Factory (Hsinchu)**



**China Training Center (Wuhan)**



# Table of Contents

# 1

## PAC Products and BoxPC

1. Compact PAC	P 1-1
2. 7188/7186 Series $\mu$ PAC	P 1-31
3. 5000 Series $\mu$ PAC	P 1-36
4. 2000 series PAC	P 1-44
5. iBPC Series BoxPC	P 1-46

# 2

## Panel Products

1. iPPC (Industrial Panel PC)	P 2-2
2. ViewPAC	P 2-4
3. IWS (InduSoft)	P 2-8
4. SmartView	P 2-11
5. TouchPAD, ViewPAD	P 2-14
6. Industrial Modbus LED Display	P 2-21
7. Touch Monitor	P 2-23

# 3

## Remote I/O Module and Unit

1. RS-485 I/O Products	P 3-2	2.3 Tiny-Size Modbus TCP I/O Modules	P 3-31
1.1 I-7000 and M-7000 Series	P 3-3	2.4 Slim-Type Modbus TCP I/O Modules	P 3-35
1.2 RS-485 I/O Expansion Unit	P 3-14	2.5 EtherNet/IP I/O Modules	P 3-36
1.3 M-2000 Series I/O Modules	P 3-15	2.6 EtherCAT Products	P 3-37
1.4 M-6000 Series I/O Modules	P 3-16	2.7 BACnet/IP I/O Modules	P 3-38
1.5 tM Series Modules	P 3-17	2.8 PROFINET Products	P 3-39
1.6 LC/SC/DALI Series	P 3-18	3. PROFIBUS I/O Products	P 3-41
2. Ethernet I/O Products	P 3-23	4. CAN Bus I/O Products	P 3-44
2.1 Ethernet Modbus TCP I/O Modules	P 3-24	5. USB I/O Modules	P 3-46
2.2 High Speed Data Logger – ET-7H16	P 3-30		

# 4

## IIoT

1. IoTstar: IIoT Cloud Management Software	P 4-2	9. Bluetooth LE Gauge Master for Mitutoyo Gauges	P 4-28
2. UA-5200 IIoT Communication Server	P 4-5	10. Stack Light Monitoring Module	P 4-29
3. WISE Series	P 4-7	11. Accelerometer Data Logger Module	P 4-31
4. iCAM Series	P 4-15		
5. MQTT I/O Module	P 4-17		
6. CL Series	P 4-18		
7. DL Series	P 4-21		
8. PIR/RPIR Series: Motion Detector	P 4-26		

# 5

## Industrial Communication

1. Multiport Serial Cards	P 5-1
2. Serial Device Server	P 5-2
3. Converter/Repeater/Hub/Splitter	P 5-19
4. Termination Resistor/DC Bias Voltage	P 5-21
5. Ethernet Switch	P 5-22
6. Fieldbus Solution	P 5-28



# Table of Contents

6

## Wireless Solution

1. WLAN Products . . . . .	P 6-1
2. Radio Modems . . . . .	P 6-10
3. 3G/4G Products . . . . .	P 6-11
4. GPS Products . . . . .	P 6-14
5. Bluetooth LE Converters . . . . .	P 6-14
6. ZigBee Products . . . . .	P 6-15
7. Infrared Wireless Modules . . . . .	P 6-18
8. Wireless Modbus Data Concentrators . . . . .	P 6-21

7

## Machine Automation

1. Motionnet Solutions . . . . .	P 7-1
2. EtherCAT Motion Control Solutions . . . . .	P 7-6
3. Ethernet & Serial Communication Motion Control Solutions . . . . .	P 7-10
4. PC-based Motion Control Cards . . . . .	P 7-13
5. PAC Solutions - Motion Modules . . . . .	P 7-15
6. Features of Motion Function . . . . .	P 7-17

8

## Energy Management Solution

1. Energy Management Solution . . . . .	P 8-1		
2. Power Meter Concentrator . . . . .	P 8-2		
3. Smart Power Meter & Devices . . . . .	P 8-6		
4. Software Utility . . . . .	P 8-7		
• Power Meter Concentrator . . . . .	P 8-8		
• Power Meter Concentrator With Display . . . . .	P 8-9		
		• Three-phase Smart Power Meter	
		▼ PM-3133-RCT/-MTCP/-CPS . . . . .	P 8-10
		▼ PM-3133/-MTCP/-CPS . . . . .	P 8-12
		▼ PM-3033/-MTCP/-CPS . . . . .	P 8-14
		• Single-phase Smart Power Meter . . . . .	P 8-16
		• Multi-circuit Smart Power Meter . . . . .	P 8-18
		• 8-channel True RMS Input Module . . . . .	P 8-21
		• Industrial Multi-power-meter Display . . . . .	P 8-23

9

## DAQ Card

1. PCI Express Data Acquisition Boards . . . . .	P 9-3	2.6 Non-Isolated Digital I/O Boards . . . . .	P 9-8
1.1 Analog I/O Boards . . . . .	P 9-3		
1.2 Digital I/O Boards . . . . .	P 9-4	3. ISA Bus Data Acquisition Boards . . . . .	P 9-9
2. PCI Bus Data Acquisition Boards . . . . .	P 9-5		
2.1 Multi-Function Boards . . . . .	P 9-5		
2.2 Memory Boards . . . . .	P 9-6		
2.3 Counter/Frequency Board . . . . .	P 9-6		
2.4 Analog Output Boards . . . . .	P 9-6		
2.5 Isolated Digital I/O Boards . . . . .	P 9-7		

10

## Accessories

1. Signal Conditioning Modules (SG-3000 Series) . . . . .	P 10-1
2. 3-channel DC Current Signal Splitter . . . . .	P 10-2
3. EMI Ferrite Split/Snap-On Core . . . . .	P 10-2
4. Surge Protection Module (SG-770) . . . . .	P 10-3
5. Relay Modules . . . . .	P 10-4
6. Enclosures and Mounting Kit . . . . .	P 10-5
7. MISC . . . . .	P 10-6



# PAC Products and BoxPC

# 1

1

## Compact PAC

P 1-1

- 1.1 XP-9000, WP-9000, LX-9000 and LP-9000 Series - - - - - P 1-10
- 1.2 XP-8000 Series - - - - - P 1-14
- 1.3 WinPAC-8000 Series - - - - - P 1-17
- 1.4 LinPAC-8000 Series - - - - - P 1-19
- 1.5 iPAC-8000 Series- - - - - P 1-21
- 1.6 Industrial I/O Modules - - - - - P 1-23

2

## 7188/7186 Series $\mu$ PAC

P 1-31

- 2.1 I/O Expansion Boards for 7188/7186 Series - - - - - P 1-34

3

## 5000 Series $\mu$ PAC

P 1-36

- 3.1  $\mu$ PAC-5000 Series - - - - - P 1-36
- 3.2 WinPAC-5000 Series - - - - - P 1-39
- 3.3 LinPAC-5000 Series - - - - - P 1-42
- 3.4 I/O Expansion Boards - - - - - P 1-43

4

## 2000 series PAC

P 1-44

- WP-2241M-CE7 (WinCE 7.0) /LP-2241M (Linux Kernel 3.2.x) - - - - - P 1-44
- XP-2031-CE6 (WinCE 6.0)/LX-2031 (Linux Kernel 3.2.x) - - - - - P 1-45

5

## iBPC Series BoxPC

P 1-46



# 1. Compact PAC

## PAC family



**iBPC**

- 3-6100U or Atom E3845 CPU
- Optional XV-board

Compact PAC	XP-9x71-WES7/XP-9x81-WES7	XP-9x3x-WES7	XP-2031-CE6	WP-9x2x-CE7
	LX-9x71/LX-9x81	LX-9x31	LX-2031	LP-9x21
Pictures				
OS	Windows Embedded Standard 7			WinCE 7.0
	Linux Kernel 3.2			
Software Development Tool	VS .NET 2008, VC6, VB6, Delphi, BCB			VS .NET 2008, Win-GRAF, InduSoft
	C language for Linux platform			
CPU	E3827 (1.75 GHz, dual core) or E3845 (1.91 GHz, quad core)	x86 CPU (1 GHz, dual core)		Cortex-A8 (1 GHz)
I/O Expansion	I/O Slots (for I-9K modules) or XV-board, RS-232/485, Ethernet			

Compact PAC	XP-8x71-WES7	XP-8x3x-WES7	XP-8x4x	WP-8x2x-CE7	WP-8x3x	iP-8000
	LX-8x71	XP-8x3x-CE6	XP-8x4x-CE6	LP-8x21	WP-8x4x	
Pictures						
	OS	Windows Embedded Standard 7	Windows Embedded Standard 7	Windows Embedded Standard 2009	WinCE 7.0	WinCE 5.0
		WinCE 6.0	WinCE 6.0			
Software Development Tool	VS .NET 2008, VC6, VB6, Delphi, BCB			VS .NET 2008 Win-GRAF, InduSoft	VS .NET 2008 ISaGRAF, InduSoft	C language, ISaGRAF
		VS .NET 2008, Win-GRAF, InduSoft	VS .NET 2008 ISaGRAF, InduSoft			
CPU	Linux Kernel 3.2		Linux Kernel 2.6			
	E3827 (1.75 GHz, dual core)	x86 CPU (1 GHz, dual-core)	AMD LX800 (500 MHz)	Cortex-A8 (1 GHz)	Marvell PXA270 (520 MHz)	80186 (80 MHz)
I/O Expansion	I/O Slots (for I-8K and I-87K modules) or XV-board, RS-232/485, Ethernet					

µPAC	WP-5231	WP-2241-CE7	WP-5000	µPAC-5000	I-7188E	I-7188XA/B/C
	LP-5231	LP-2241	LP-5000		uPAC-7186E	
Pictures						
OS	WinCE 7.0		WinCE 5.0	MiniOS7	MiniOS7	MiniOS7
	Linux kernel 3.2		Linux kernel 2.6			
Software Development Tool	VS .NET 2008 Win-GRAF, InduSoft		VS .NET 2005/2008 ISaGRAF, InduSoft	C language, ISaGRAF	C language, ISaGRAF	C language, ISaGRAF
	C language for Linux platform					
CPU	Cortex-A8 (1 GHz)		Marvell PXA270 (520 MHz)	80186 (80 MHz)	80188 (40 MHz)	80188 (40 MHz)
I/O Expansion	XV-board		XW-board		X-board	



## Features:

### 1 Powerful embedded OS

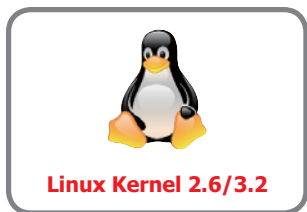

### 2 Powerful Hardware Design

The PAC family of ICP DAS with powerful hardware design can operate in harsh, electrically noisy environments and provide faster & more professional performance. This has been achieved through attention to the following:

### 3 Built-in Dual Watchdog Timers

The integrated watchdog circuit will reset the CPU module if there is a failure in either the hardware or software.

### 4 Wide Operating Temperature

The PAC product is designed to operate under a very wide temperature range from -25°C ~ +75°C.



### 5 Easy-to-Install

The PAC family is easy-to-installed by either DIN-Rail mounting or Rack mounting. Input signals can be connected to the unit with easy using plug in signal connectors.



DIN-Rail Mounting

### 6 Input Protection circuitry

The protection circuitry on both the network and power supply protects the system from external signals such as main spikes and ambient electrical noise. In addition the central processing modules are isolated three ways from external signals. This is through I/O isolation of 3 kV, network isolation to 3 kV and power isolation to 1000 V.

### 7 I/O Expansion Slots

The compact PAC family provide a number of slots. Over 100 I/O, communication and motion control modules are available.



### 8 Cost-effective Display Solution

The user chooses LCD monitor instead of the HMI



**Software:**

**1. Win-GRAF (PAC / Soft PLC Development Kit)**

**Win-GRAF** is a powerful SoftLogic development software and PLC-like SoftLogic package that supports IEC 61131-3 Standard Open PLC Languages running on Windows 7 and Windows 8. The Win-GRAF Runtime application can run on any ICP DAS PAC (Programmable Automation Controller) that supports the Win-GRAF, such as the WinPAC series WP-5238-CE7, WP-8xx8, WP-8xx8-CE7 and WP-9xx8-CE7, or the touch panel ViewPAC series VP-x2x8-CE7, or the advanced CPU XPAC-CE6 series XP-8x48-CE6. Using the Win-GRAF software with ICP DAS Win-GRAF PACs, the control/monitor systems can easily implement industrial level of data acquisition and logic control in various industry fields.



**Applications:**

- Data Acquisition System
- Building Automation
- Factory Automation
- Remote I/O system
- Wireless Monitor/Control System
- Motion Control System ...

**Win-GRAF Workbench Features:**

- ▶ **Support IEC 61131-3 Standard Open PLC Languages:**
  1. Ladder Diagram (LD)
  2. Function Block Diagram (FBD)
  3. Sequential Function Chart (SFC)
  4. Structured Text (ST)
  5. Instruction List (IL)
- ▶ **Using ST Syntax in the FBD or LD Program**
- ▶ **Online Debugging/Control/Monitoring**
- ▶ **Offline Simulation on the PC**
- ▶ **Online Change:**  
Replace the current running project to a new modified one without stopping the project
- ▶ **Event Triggered Data Binding:**  
Exchange data between PACs.
- ▶ **Upload Source Code From the PAC to the PC**
- ▶ **Recipe:**  
Apply multi-recipes pre-defined in PC/Win-GRAF to PAC.
- ▶ **Spy List:**  
Show several selected variables in one Spy List window.

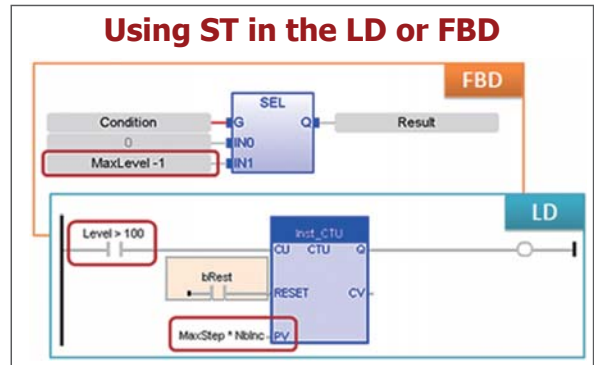
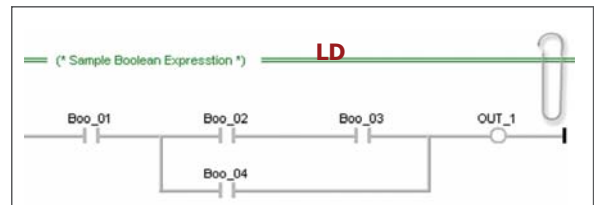

**Online Change**



**Event triggered Data Binding**

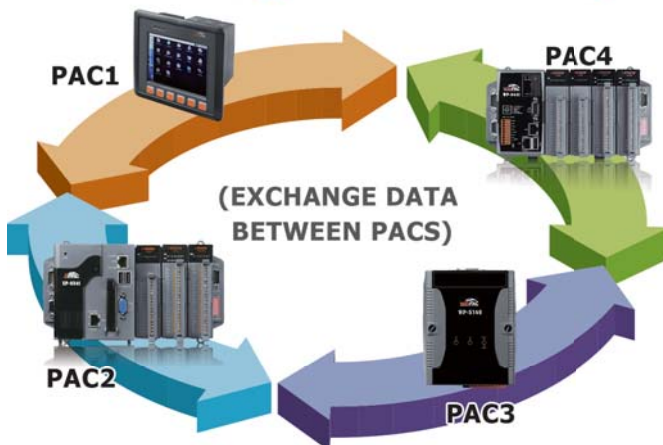



- ▶ **Modbus Master Protocol**
  - Multi-port Modbus RTU, ASCII Master, RS-232/485/422
  - Modbus TCP Master (Multiple connections)
  - Connect other Modbus PLC, Modbus Master, Modbus I/O and Modbus devices
- ▶ **Modbus Slave Protocol**
  - Multi-port Modbus RTU Slave, RS-232/485/422
  - Modbus TCP Slave (Multiple connections)
  - Connect PC/SCADA/HMI
- ▶ **Support File Access & Data Log**
- ▶ **Support eLogger HMI**
- ▶ **Support DCON I/O**

Support RS-485 Port to connect the ICP DAS I-7000 I/O modules, and I-87K4/5/8/9 Expansion Unit plus I-87xxxW I/O boards, and RU-87P4/8 Expansion Unit plus I-87xxxW I/O boards.
- ▶ **Support a Variety of I/O Boards**

Support I-8xxxW and I-87xxxW I/O boards, such as: DI, DO, AI, AO, Relay, AC-IN, Thermistor, Thermocouple, RTD, Strain Gauge, Encoder, PWM output, Counter, Frequency, etc.
- ▶ **Support Temperature/Humidity Modules**

DL-100T485 and DL-100TM485.

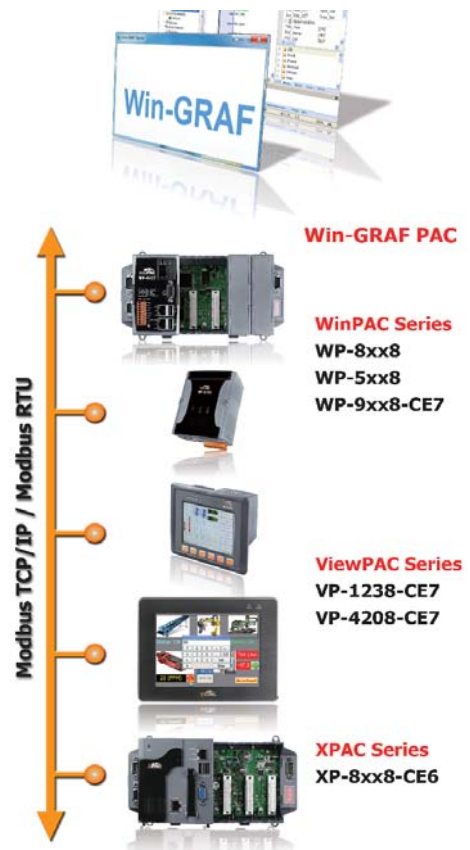

Win-GRAF PAC Series	Win-GRAF PAC Models
ViewPAC Series	VP-1238-CE7, VP-2208-CE7, VP-4208-CE7
WinPAC Series	WP-8148, WP-8448, WP-8848, WP-5238-CE7, WP-8x28-CE7, WP-9xx8-CE7
XPAC-CE6 Series	XP-8x48-CE6

- ▶ **Support Retain Variables**

All Win-GRAF PACs support Suitable to retain the data changed quickly and frequently.
- ▶ **Protect Application by Own Algorithm**

Protect the Win-GRAF application by user-defined algorithm. Even others copy the application to the same model PAC, as long as he cannot get the source code, can not run the application correctly.
- ▶ **Redundant Solution**

XP-8xx8-CE6 support the Win-GRAF redundant system to achieve the more secure engineering applications.
- ▶ **Schedule-Control**

- ▶ **Support VS 2008/VS 2010 Development:**

The Win-GRAF PACs support to use VS 2008 or VS 2010 (VB.net, C#) to develop user own HMI and data management programs, and can exchange variables with the Win-GRAF control programs.

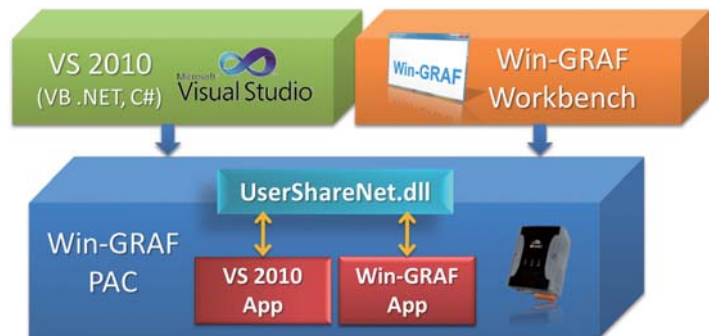

• **Ordering Information:**

Win-GRAF Development Software	
Win-GRAF Workbench	Win-GRAF Workbench Software (Large I/O Tags) with one USB Dongle

## 2. ISaGRAF (SoftPLC Solution)

ISaGRAF is a powerful SoftLogic package on the industrial market. **ISaGRAF Workbench** is a PLC-like development software running on Windows 95/98/NT/2000/XP/Vista/7 and its **ISaGRAF Runtime** application programs can run on any **ISaGRAF PACs**. Using ISaGRAF PACs, the control/monitor systems can easily implement industrial level of real-time data acquisition and data/devices control via wiring or wireless network in various industries.

**Application area:** data acquisition system, distributed control system, factory and building automation, motor control, remote I/O system, wireless control system...

### • ISaGRAF Workbench Features:

- ▶ Support IEC 61131-3 Standard Open PLC Languages
  - + Flow Chart (FC) :
  - 1. Quick Ladder (LD)
  - 2. Function Block Diagram (FBD)
  - 3. Sequential Function Chart (SFC)
  - 4. Structured Text (ST)
  - 5. Instruction List (IL)
  - 6. Flow Chart (FC)
- ▶ Online debugging/control/monitoring
- ▶ Offline simulation
- ▶ Online change (For WP-8xx7, VP-2xW7, XP-8xx7-CE6 only)
- ▶ Spotlight: Simple graphic HMI
- ▶ Auto-Scan I/O
- ▶ Uploading the program in the PAC

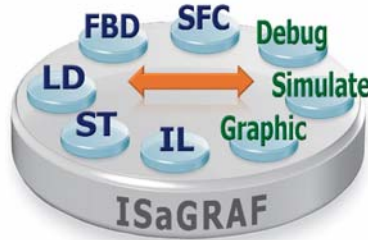

### • ISaGRAF Solution Features:

- ▶ Modbus Master Protocol
  - Modbus RTU, ASCII, RS-232/485/422 Master
  - Modbus TCP Master
  - For connecting other Modbus PLCs, meters, I/Os and devices
- ▶ Modbus Slave Protocol
  - Modbus RTU (RS-232/485/422) Slave
  - Modbus TCP/IP Slave
  - For connecting other PC/HMI/SCADA (Ex. InduSoft) and touch HMI
- ▶ Data-Recorder & Data-Logger
- ▶ Data Exchange
  - Ebus: Through Ethernet
  - Fbus: Through RS-485
  - PAC to PAC
- ▶ CAN/CANopen
  - Via I-7530 to connect CAN/CANopen devices
  - For connecting other CAN/CANopen meters, I/Os, devices
- ▶ Motion Control
  - For controlling server motors (P-command)
- ▶ PAC can send e-mail to the internet
- ▶ SMS: Short Message Service: GSM modem
  - For reporting data and alarms to the operators
- ▶ Wireless Communication: GPS, ZigBee & Radio
- ▶ Auto-report Acquisition/Control Data
- ▶ Redundant Solution : Hot-swap/Ethernet
- ▶ Construction Stress Monitoring: VW sensor and Carlson strain gauge inputs solutions (Bridge/dam/building...)

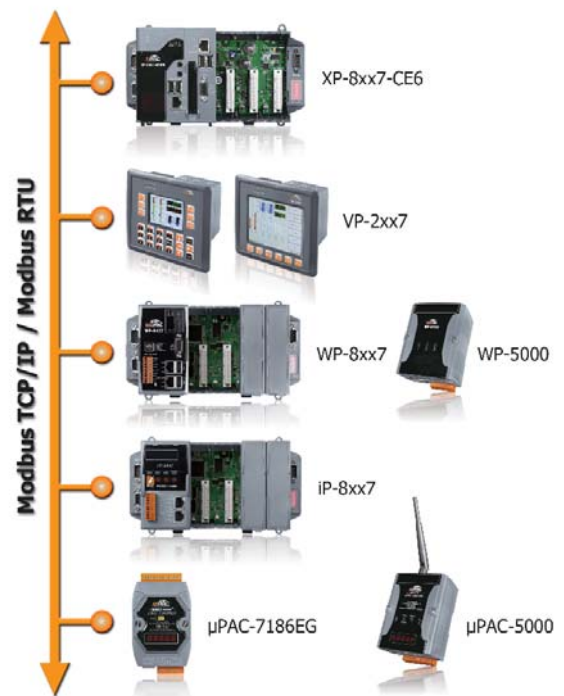

### Software Development: ISaGRAF V.S. C++ and VS.net 2008

Item	ISaGRAF Ver. 3.xx	C++	VS.net 2008
Programming	Easy	Hard	Middle hard
Debug	Easy	Hard	Middle hard
SoftLogic	Yes	No	No
Program I/O	Just connect and play	Hard coding	Hard coding
Communication	Already built-in Modbus TCP, Modbus RTU, Modbus ASCII, DCON, SMS, e-mail, TCP, UDP, ...	Hard coding	Hard coding



### 3. InduSoft (SCADA Solution)



#### Introduction :

InduSoft Web Studio is a powerful, integrated collection of automation tools that includes all the building blocks needed to develop modern Human Machine Interfaces (HMI), Supervisory Control and Data Acquisition (SCADA) systems, and embedded instrumentation and control applications.

InduSoft Web Studio's application runs in native Windows NT, 2000, XP, CE and CE .NET environments and conforms to industry standards such as Microsoft .NET, OPC, DDE, ODBC, XML, and ActiveX. We provide the InduSoft bundled driver to integrate InduSoft software into ICP DAS products (IO Modules: I-7000, I-8000, I-87K ; PACs: WinPAC, WinPAC, XPAC) for SCADA system.

#### Integrated with ICP DAS PACs :

InduSoft has been integrated into ICP DAS various PACs including WinPAC, ViewPAC, XPAC and XPAC-CE6. The following is the advantages when using InduSoft with ICP DAS PACs.

	Features
<b>WinPAC</b>	<ul style="list-style-type: none"> <li>Stable and high performance-to-price ratio small SCADA system</li> <li>Rapidly and easily develop I/O integrated graphic supervisory control system</li> </ul>
<b>ViewPAC</b>	<ul style="list-style-type: none"> <li>Provide integrated touch HMI/SCADA system solution</li> <li>Suitable for spatial narrow and small machine control system</li> </ul>
<b>XPAC</b>	<ul style="list-style-type: none"> <li>High performance and various Win32 API and Tool integrated SCADA system</li> <li>Easily integrate third party software for multi-purpose application</li> </ul>
<b>XPAC-CE6</b>	<ul style="list-style-type: none"> <li>Provide the best choice for high efficiency real time embedded system</li> <li>Suitable for massive data acquisition and processing centralized system</li> </ul>

#### Features:

- Elegant Graphics
- Multi-Language
- Database (Access, Excel, SQL, Oracle...)
- Recipes and Reports
- Online and History Alarm / Trend
- Various Communication Driver (DCON, Modbus, OPC, DDE, TCP/IP...)
- Remote Web Client Control & Security
- ActiveX (GSM / SHM / COM /WEB provided by ICP DAS)
- System Redundancy
- Others (VBScript, E-mail, FTP, SNMP...)

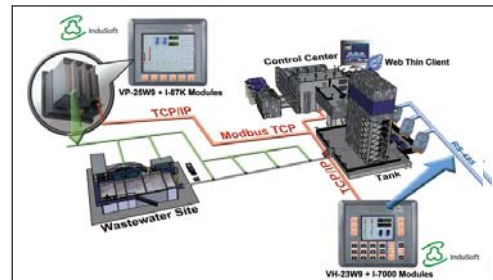
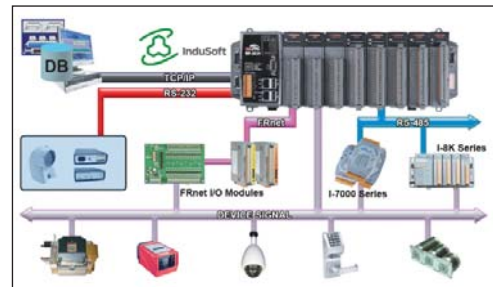
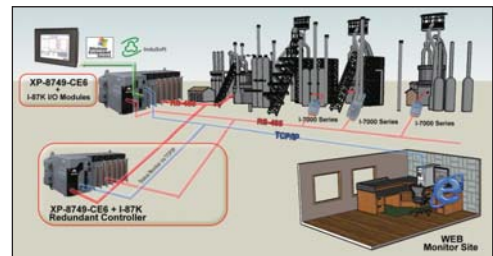
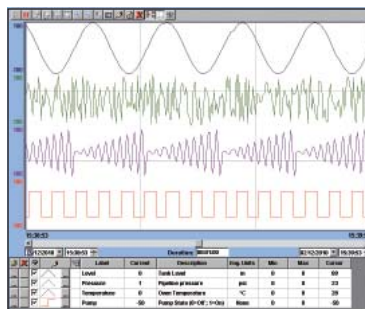
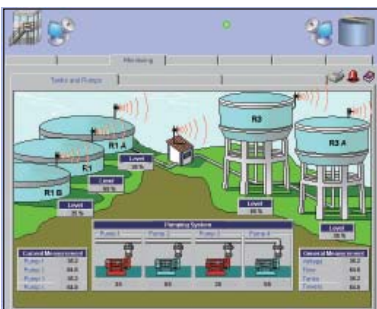

## 4. EZ Data Logger

# EZ Data Logger

**DCON**  
**Modbus TCP**  
**Modbus Serial**

★Virtual Channel Definition

★Control Logic (VB Script)

★Alarm Notifier

High/Low Alarm

★IP Camera Viewer

Layout

Data Trend

Time	Value	Value	Value	Value	Value
10:00	10.00	20.00	30.00	40.00	50.00
10:05	12.00	22.00	32.00	42.00	52.00
10:10	15.00	25.00	35.00	45.00	55.00
10:15	18.00	28.00	38.00	48.00	58.00
10:20	20.00	30.00	40.00	50.00	60.00
10:25	22.00	32.00	42.00	52.00	62.00
10:30	25.00	35.00	45.00	55.00	65.00
10:35	28.00	38.00	48.00	58.00	68.00
10:40	30.00	40.00	50.00	60.00	70.00
10:45	32.00	42.00	52.00	62.00	72.00
10:50	35.00	45.00	55.00	65.00	75.00
10:55	38.00	48.00	58.00	68.00	78.00
11:00	40.00	50.00	60.00	70.00	80.00
11:05	42.00	52.00	62.00	72.00	82.00
11:10	45.00	55.00	65.00	75.00	85.00
11:15	48.00	58.00	68.00	78.00	88.00
11:20	50.00	60.00	70.00	80.00	90.00
11:25	52.00	62.00	72.00	82.00	92.00
11:30	55.00	65.00	75.00	85.00	95.00
11:35	58.00	68.00	78.00	88.00	98.00
11:40	60.00	70.00	80.00	90.00	100.00
11:45	62.00	72.00	82.00	92.00	100.00
11:50	65.00	75.00	85.00	95.00	100.00
11:55	68.00	78.00	88.00	98.00	100.00
12:00	70.00	80.00	90.00	100.00	100.00

Database and Report

EZ Data Logger is the software that ICP DAS provides for users to easily build a SCADA system on Windows 2000/XP/Vista. It comes with two versions, "Lite" & "Professional". The Lite version is not only full-functioned but free to all ICP DAS users!

EZ Data Logger is a small data logger software. It can be applied to small remote I/O system. With its user-friendly interface, users can quickly and easily build a data logger software without any programming skill.

### Features:

- Support DCON, Modbus RTU, Modbus ASCII, Modbus TCP protocols
- Support multiple COM Ports and TCP/IP connections
- Support Virtual Channel definition
- Support Control Logic (VB Script)
- Support Alarm Notifier (by sending SMS to cell phone or E-Mail)
- Flexible module configuration (different description and color)
- Flexible workgroup configuration
- Real time data trend (with zoom in and zoom out)
- Each trend line can store more than 86400 records.
- Provide Layout view
- Provide IP Camera Viewer
- Access database supported (can be exported to Excel file or CVS file)
- Provide Reporter to print trend line or data
- Provide High/Low alarm with audio warning
- Can search for DCON (I-7000/8000/87K) modules and Modbus (M-7000) serial modules
- Provide Value scaling
- All operations are done by click mouse and enter value.

NOW! FREE

# EZ DATA LOGGER Lite

Build your SCADA system with ICP DAS modules in 5 minutes.

Watch the video & Download the "Lite" Version **FOR FREE** now!

The screenshot displays a comprehensive SCADA dashboard with the following components:

- Analog Indicators:** Three circular gauges labeled AI0 (62.608), AI2 (49.047), and AI1 (20.996).
- Control Elements:** A row of buttons for digital outputs: D10, D15, D12 (ON), D17 (Safe), and D00 (On).
- Bar Charts:** Two vertical bar charts for AI3 (49.667%) and AI4 (30.434%).
- Counters:** A digital counter for AI01 showing 25.230 and another for AI0 showing 32.743.
- Other Elements:** A 'Counter 0' display showing 000000141 and a 'Timer 1.000' display.

1-7

ICPDAS CO., LTD.

Professional Provider of High Quality Industrial Computer Products and Data Acquisition Systems

Vol. FPC 2.06.10



## 5. eLogger

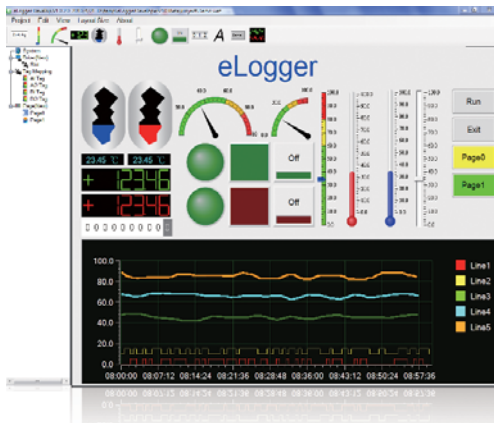

eLogger is an easy-to-use software to implement HMI and data logger on our Windows CE.NET 5.0/6.0 based PACs (XPAC, WinPAC and ViewPAC) for simple I/O monitoring and controlling systems. It can save your money and shorten time-to-market.

eLogger can quickly and easily develop an application with flexible I/O configuration. The developing can be completed in just 5 simple steps:

- Step 1: configuring I/O modules
- Step 2: configuring data logger
- Step 3: designing HMI layout pages
- Step 4: uploading the project to WinPAC/ViewPAC
- Step 5: running it.

In the simple steps, there is no need of software programming knowledge. And if you want to add more powerful functions, eLogger also provides a flexible "shared memory" interface to allow your VS.NET and ISaGRAF programs co-

work with it. eLogger currently supports I-87K series I/O modules on local slots. In the future, it will support I-8K series I/O modules on local slots and remote I/O modules over RS-485, Ethernet with DCON and Modbus protocols. With the various I/O module series, you can find I/O modules to suit various configurations.

### Features:

#### 1. PAC Support:

- Developer: Windows 2K, Windows XP, Windows Vista, Windows 7
- Run time target: Windows CE.NET 5.0/6.0 platform, such as XP-8x4x-CE6 series, WP-8x3x series, WP-8x4x series, VP-25W1

#### 2. Driver Support:

- Module on slot
  - ▷ I-8K series: I-8017HW, I-8024W, and all I-8K DIO module.
  - ▷ I-87K series: DI, DO, AI, AO, counter, frequency, DI with latch function.
- Modbus serial master( support Modbus RTU/ Modbus ASCII)
  - ▷ M-7000.
  - ▷ Modbus RTU devices/Modbus ASCII devices.

- Modbus TCP master
  - ▷ ET-7000/PET-7000 series.
  - ▷ Modbus TCP devices.
- Modbus TCP server

#### 3. HMI

- Elements: button, text box, linear gauge, angular gauge, LED numeral, LED indicator, tank, label, trend line.



#### 4. Web Server

- Support elements: Text Box, Seven Segment, Label, Button, Picture Toggle.
- Support administrator login.
- Support browsers: Google Chrome, Internet Explorer, Firefox, Safari.



#### 5. Real Time Data Trend

- Zoom in and zoom out
- Max. of 5 trend lines in one page.

#### 6. Value Scaling

#### 7. Account Management

#### 8. Remote Maintenance

#### 9. Data Base

- Local data base: SQL embedded.
- Remote data base: SQL 2005 on Windows platform.

#### 10. Logic Control Programming

Via the " shared memory " , you can choose ISaGRAF or VS.Net to develop a logic control program and co-work with the eLogger. Your programs can access the data of I/O module and exchange other temporary data through the "shared memory". You can focus on the logic control programming.

- Win-GRAF  
(IEC61131-3 standard PLC languages) (Refer to Win-GRAF FAQ-018)
- ISaGRAF  
(IEC61131-3 standard PLC languages) (Refer to ISaGRAF FAQ-115)
- Visual Studio .NET (C#, VB.NET) for  
Window CE.NET 5.0/6.0

#### 11. Support ISAPI

- You can read/write the shared memory by calling ISAPI URL.  
It helps you to design a HMI web page with javascript.

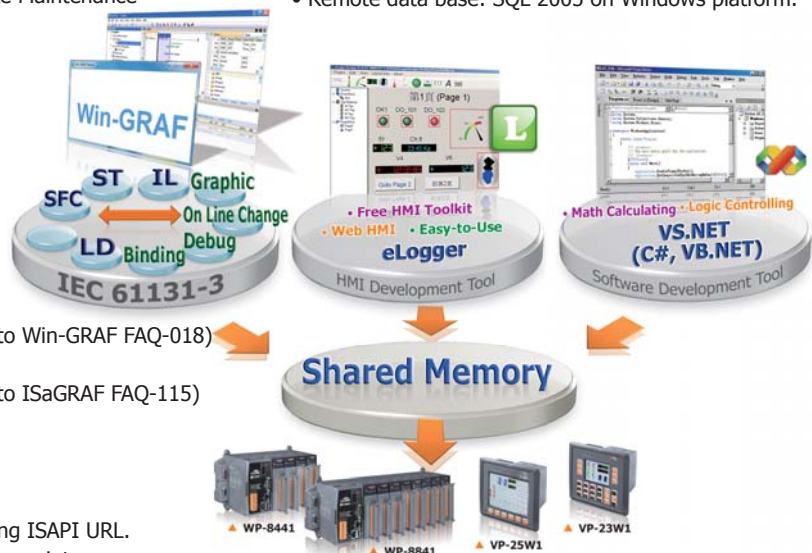

## 6. NAPOPC DA Server

**NAPOPC DA Server** is a **free** OPC DA Server (**The "OPC" stands for "OLE for Process Control" and the "DA" stands for "Data Access"**) provided by ICP DAS running on WinPAC, ViewPAC, XPAC, WinCon and PC with Windows 95/98/ME/2000/NT/XP operating systems. **NAPOPC DA Server** provides many benefits to users such as reduce time through lower system integration costs, integrate easily with plug-and-play SCADA/HMI/Database, connect and interoperate easily to custom applications, access to data by anyone in the automation hierarchy, reduce troubleshooting and maintenance cost, write to devices synchronously and asynchronously (not possible before OPC).

Using SCADA/HMI/Database software program, system contacts and obtains data from NAPOPC DA Server either on the same computer or on another computer. SCADA/HMI/Database makes a request and NAPOPC DA Server fulfills the request by gathering the data of ICP DAS modules and third-party devices to SCADA/HMI/Database.

For different OS of PAC products, ICP DAS provides several professional DA Servers, such as:

- NAPOPC\_ST DA Server : For Windows 95/98/2000/NT/XP/7 OS
- NAPOPC\_XPE DA Server : For Windows XP Embedded OS
- NAPOPC\_CE5 DA Server : For Windows CE 5.0 OS
- NAPOPC\_CE6 DA Server : For Windows CE 6.0 OS

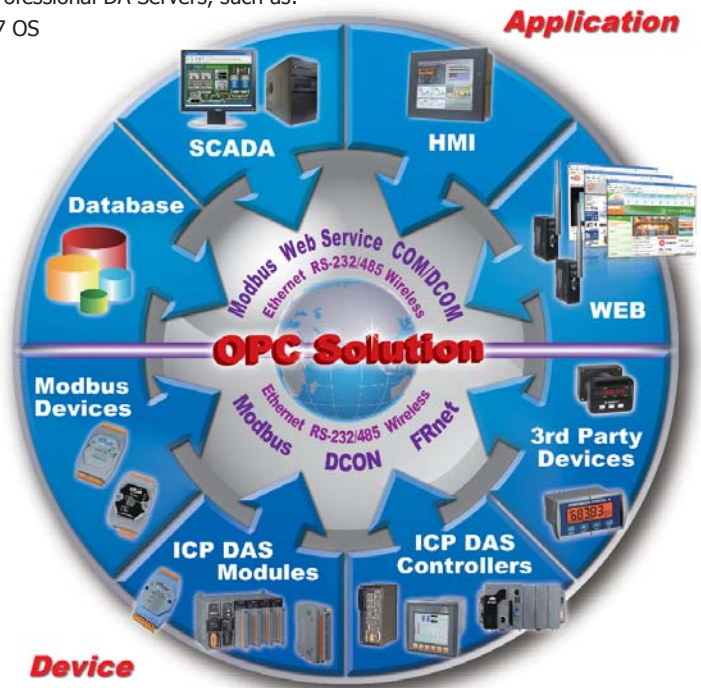

### Features:

- Easy-to-use explorer-style user interface
- Multi-thread communication
- Auto search & Auto generate
- Support Modbus devices
- Provide "OPC to Modbus" service
- Support Host Watchdog
- Unique design:
  - Active data transmission mechanism
  - OPC Client can select the document in the DA Server during runtime
  - Open application programming interface

### Support :

- ICP DAS I-7K/I-8K/I-87K/M-7K/tM Series I/O modules
- ICP DAS ZigBee I/O
- ICP DAS Ethernet I/O
- Support third party Modbus devices
- ICP DAS PACs which support Modbus protocol
- Compatible with most development platforms (Visual C++, Visual Studio .Net)
- Compatible with all local and remote OPC Client (Remote Accessing using DCOM technique)
- Compliant with OPC specification V2.0

### Applications :

- Protocol Conversion Application
- VxComm Application
- Wireless I/O Application
- Active Server to Client Communication Application
- Direct Cross-Process I/O Access Application

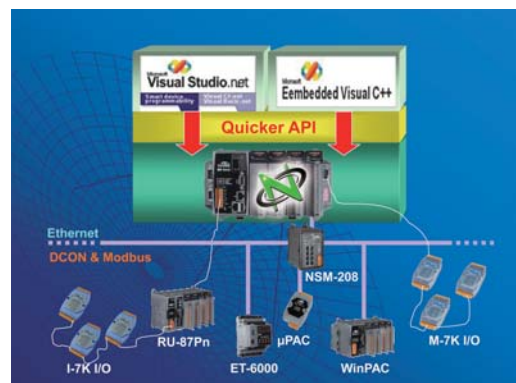
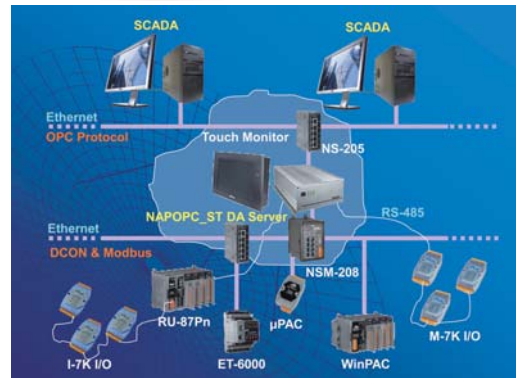



**Open System**

# 1.1 XP-9000, WP-9000, LX-9000 and LP-9000 Series



## Introduction:

The XP-9000 is a compact (3U), rugged PAC. It provides the X86 CPU, dual Gigabit ethernet, four USB ports, LED indicators, VGA ports, CF card slot and redundant power input. It is a upgrade version of XP-8000. The XP-9000 combines the functionality and openness of PC, the reliability of a programmable logic controller (PLC), and the intelligence of I/O modules. Moreover, XP-9000 can be widely used in Factory Automation, Building Automation, Machine Automation, Laboratory Automation, Chemical industry, enviromental monitoring, M2M, IIOT, Industrial 4.0 ...etc

## Selection Guide:

**XP-9**     **X**     **8**     **X**     -     **OS**

**NO. of I/O Slot**     **CPU**     **Software**

**3: x86 CPU, 1.0 GHz**  
**7: E3827**  
**8: E3845**

**1: Standard**  
**9: InduSoft**

**HDMI version coming soon**

**Standard XPAC**

Model Name	OS	CPU	Flash	SDRAM	VGA Resolution	Ethernet Port	RS-232/RS-485	I/O Slot
XP-9181-WES7	WES7	E3845 1.91 GHz, quad core	32 GB	4 GB DDR3	1920 × 1080	2	4	1
XP-9381-WES7								3
XP-9781-WES7								7
XP-9171-WES7		E3827 1.75 GHz, dual-core		2 GB DDR3				1
XP-9371-WES7								3
XP-9771-WES7								7
XP-9131-WES7		x86 CPU, 1.0 GHZ, dual-core						1
XP-9331-WES7								3
XP-9731-WES7								7

**InduSoft Based PAC**

Model Name	OS	CPU	Flash	SDRAM	VGA Resolution	Ethernet Port	RS-232/RS-485	I/O Slot
XP-9189-CE7	CE 7.0	E3845 1.91 GHz, quad core	32 GB	4 GB DDR3	1920 × 1080	2	4	1
XP-9389-CE7								3
XP-9789-CE7								7

XP-9x89-CE7 is InduSoft-CE300R (300 tags and 3 drivers) runtime embedded. InduSoft-CE1500R (1500 tags and 3 drivers) is optional.

1 PAC Products and BoxPC

2 Panel Products

2

3 Remote I/O Module and Unit

3

IIoT

4





**Introduction:**

The WP-9000 is a compact (3U), rugged PAC. It provides Cortex-A8 ARM CPU, dual gigabit ethernet, two USB ports, VGA ports, SD card slot and redundant power input. It is a upgrade version of WP-8000. Moreover, WP-9000 can be widely used in Factory Automation, Building Automation, Machine Automation, Laboratory Automation, Chemical industry, enviromental monitoring, M2M, IIOT, Industrial 4.0 ...etc

**Selection Guide:**

**WP-9**



NO. of I/O Slot



CPU  
2: Cortex-A8, 1 GHz



Software  
1: Standard  
8: Win-GRAF  
9: InduSoft

**- CE7**

Standard PAC

Model Name	OS	CPU	Flash	SDRAM	VGA Resolution	Ethernet Port	RS-232/RS-485	I/O Slot
WP-9221-CE7	CE 7.0	Cortex-A8, 1.0 GHz	256 MB	512 MB DDR3	1024 × 768	2	4	2
WP-9421-CE7								4
WP-9821-CE7								8

Win-GRAF Based PAC

Model Name	OS	CPU	Flash	SDRAM	VGA Resolution	Ethernet Port	RS-232/RS-485	I/O Slot
WP-9228-CE7	CE 7.0	Cortex-A8, 1.0 GHz	256 MB	512 MB DDR3	1024 × 768	2	4	2
WP-9428-CE7								4
WP-9828-CE7								8

InduSoft Based PAC

Model Name	OS	CPU	Flash	SDRAM	VGA Resolution	Ethernet Port	RS-232/RS-485	I/O Slot
WP-9229-CE7	CE 7.0	Cortex-A8, 1.0 GHz	256 MB	512 MB DDR3	1024 × 768	2	4	2
WP-9429-CE7								4
WP-9829-CE7								8

**Introduction:**



The LX-9000 is a compact (3U), rugged PAC. It provides the multi-core or E3845 X86 CPU, dual Gigabit ethernet, four USB ports, LED indicators, VGA ports, CF card slot and redundant power input and running a Linux kernel 3.2 or later version operating system.

The LP-9000 is a compact (3U), rugged PAC. It provides Cortex-A8 ARM CPU, dual gigabit ethernet, two USB ports, VGA ports, SD card slot and redundant power input and running a Linux kernel 3.2 operating system.. The LX-9000 and LP-9000 are upgrade version of LP-8000 and can be widely used in Factory Automation, Building Automation, Machine Automation, Laboratory Automation, Chemical industry, enviromental monitoring, M2M, IIOT, Industrial 4.0 ...etc.

**Selection Guide:**

**LP**  
**LX**     **-9**



		
↓	↓	↓
<b>NO. of I/O Slot</b>	<b>CPU</b>	<b>Software</b>
	2: Cortex-A8, 1 GHz 3: x86 CPU, 1 GHz 7: E3827 8: E3845	1: Standard

 **Standard XPAC**

Model Name	OS	CPU	Flash	SDRAM	VGA Resolution	Ethernet Port	RS-232/RS-485	I/O Slot
LP-9221	Linux kernel 3.2	Cortex-A8, 1.0 GHz	512 MB	512 MB DDR3	1280 × 1024	2	4	2
LP-9421								4
LP-9821								8
LX-9131	Linux kernel 3.2	x86 CPU, 1.0 GHz, dual-core	32 GB	2 GB DDR3	1920 × 1080	2	4	1
LX-9331								3
LX-9731								7
LX-9171	Linux kernel 4.4	E3827 1.75 GHz, dual-core	32 GB	2 GB DDR3	1920 × 1080	2	4	1
LX-9371								3
LX-9771								7
LX-9181	Linux kernel 4.4	E3845 1.91 GHz, quad core	32 GB	4 GB DDR3	1920 × 1080	2	4	1
LX-9381								3
LX-9781								7

## ➤ Analog Modules

### ✓ Analog Input Modules



Model Name	Bus	Analog Input		
		Channels	Input Range	Sensor
I-9014	Parallel	8/16	$\pm 10\text{ V}$ , $\pm 5\text{ V}$ , $\pm 2.5\text{ V}$ , $\pm 1.25\text{ V}$ , $\pm 20\text{ mA}$ (with external $125\ \Omega$ resistor)	-
I-9014C		8	$\pm 20\text{ mA}$ (with built-in $125\ \Omega$ resistor)	
I-97015	Serial	8	-	Pt100, Pt1000, Ni100, Ni120, Cu50, Cu100, Cu1000
I-9017Z	Serial	10/20	$\pm 150\text{ mV}$ , $\pm 500\text{ mV}$ , $\pm 1\text{ V}$ , $\pm 5\text{ V}$ , $\pm 10\text{ V}$ , $0 \sim 20\text{ mA}$ , $4 \sim 20\text{ mA}$ , $\pm 20\text{ mA}$ (Jumper selectable)	-
I-9017	Parallel	8/16	$\pm 10\text{ V}$ , $\pm 5\text{ V}$ , $\pm 2.5\text{ V}$ , $\pm 1.25\text{ V}$ , $\pm 20\text{ mA}$ (with external $125\ \Omega$ resistor)	
I-9017-15		15/30		
I-9017C-15		15		
I-97018	Serial	8	$\pm 2.5\text{ V}$ , $\pm 1\text{ V}$ , $\pm 500\text{ mV}$ , $\pm 100\text{ mV}$ , $\pm 50\text{ mV}$ , $\pm 15\text{ mV}$ , $\pm 20\text{ mA}$ , $0 \sim 20\text{ mA}$ , $4 \sim 20\text{ mA}$ (Jumper selectable)	Thermocouple: J, K, T, E, R, S, B, N, C, L, M, LDIN43710
I-97019	Serial	8	$\pm 15\text{ mV}$ , $\pm 50\text{ mV}$ , $\pm 100\text{ mV}$ , $\pm 150\text{ mV}$ , $\pm 500\text{ mV}$ , $\pm 1\text{ V}$ , $\pm 2.5\text{ V}$ , $\pm 5\text{ V}$ , $\pm 10\text{ V}$ , $0 \sim 20\text{ mA}$ , $4 \sim 20\text{ mA}$ , $\pm 20\text{ mA}$ (Jumper selectable)	

### ✓ Analog Output Modules



Model Name	Bus	Analog Outputs			
		Channels	Resolution	Output Range	Wiring Current Output
I-9024	Parallel	4	14-bit	$\pm 10\text{ V}$ , $0 \sim 20\text{ mA}$	Sink
I-9024U			16-bit	$0 \sim 5\text{ V}$ , $\pm 5\text{ V}$ , $0 \sim 10\text{ V}$ , $\pm 10\text{ V}$ , $0 \sim 20\text{ mA}$ , $4 \sim 20\text{ mA}$	Source
I-97024U	Serial	8	16-bit	$0 \sim 5\text{ V}$ , $\pm 5\text{ V}$ , $0 \sim 10\text{ V}$ , $\pm 10\text{ V}$ , $0 \sim 20\text{ mA}$ , $4 \sim 20\text{ mA}$	Source
I-9028U	Parallel	8	16-bit	$0 \sim 5\text{ V}$ , $\pm 5\text{ V}$ , $0 \sim 10\text{ V}$ , $\pm 10\text{ V}$ , $0 \sim 20\text{ mA}$ , $4 \sim 20\text{ mA}$	Source
I-97028U	Serial				

## ➤ Digital Modules



Model Name	Bus	Digital Input			Digital Output			
		Channels	Sink/Source	ON Voltage Level	Channels	Type	Sink/Source	Max. Load
I-9040P	Parallel	32	Sink/Source	$19 \sim 30\text{ VDC}$	-	-	-	-
I-9041P		-	-	-	32	Open Collector	Sink	100 mA/Channel
I-9048		8	Sink/Source with Interrupt	$+4\text{ V} \sim +30\text{ V}$	-	-	-	-
I-9053P		16	Sink/Source	$19 \sim 30\text{ VDC}$	-	-	-	-
I-9057P		-	-	-	16	Open Collector	Sink	200 mA/Channel
I-9064		-	-	-	8	Power Relay	Form A	5 A/Channel

## ➤ Motion Control Modules



Model Name	Encoder Input						Compare Trigger Output	
	Axis	Counter	Counting Rate (cps)	Signal	Hardware Latch/Reset	Channels	Type	
I-9093	3	32-bit	6 M (CW/CCW, Pulse/Dir) 2 M (A/B)	CW/CCW, Pulse/Dir, A/B	3	3	Open collector	

Model Name	Encoder Input				Command Pulse Output			
	Axis	Counter	Counting Rate (cps)	Signal	Axis	Speed (pps)	Counter	Signal
I-9094F	4	32-bit	4 M	CW/CCW, A/B	4	4 M	32-bit	CW/CCW, Pulse/Dir
I-9196F	6		12 M		6			CW/CCW, Pulse/Dir, A/B

## ➤ Serial Communication Modules

Model Name	Bus	Ports	Type	Isolation
I-9114i	Parallel	4	RS-232	Yes
I-9144i	Parallel	4	RS-422/485	Yes
I-9142i	Parallel	2	RS-422/485	Yes
I-9172	Parallel	2	FRnet	Yes



# 1.2 XP-8000 Series

## Introduction:



The XP-8000 combines the functionality and openness of PC, the reliability of a programmable logic controller (PLC), and the intelligence of I/O modules. Compared to PC and PLC, the price/performance of PAC is the best. Moreover, XP-8000 can be widely used in Factory Automation, Building Automation, Machine Automation, Laboratory Automation, chemical industry, environmental monitoring, M2M, IoT, Industrial 4.0, ...etc.

### XP-8000 ≙ IPC+I/O Cards



## Main Components:

### 1 Main Control Unit (MCU)

The MCU is the powerhouse of the XP-8000. Each MCU comprises a Central Processor Module (CPM), a power supply, and a 1, 3, 7-slot backplane for I/O modules. The CPM is powerful integrated processing engine comprising a CPU, RAM and ROM, and an option of communication interfaces including Ethernet, RS-485, RS-232, and CAN bus.

### 3 I/O Modules

There are two types of I/O communication bus, parallel bus and serial bus. The parallel bus type I/O modules (high profile I-8K series) are high speed ones used only in the PACs including XPAC, WinPAC, iPAC, ViewPAC, etc. And the serial bus type I/O modules (high profile I-87K series) are low speed ones used in both PACs including XPAC, WinPAC, iPAC, ViewPAC, etc., and I/O expansion units including RU-87Pn, ET-87Pn, USB-87Pn, etc.

### 4 Remote I/O Expansion

XP-8000 uses built-in RS-485 and Ethernet ports to connect RS-485/Ethernet remote I/O units (RU-87Pn/ET-87Pn) or modules (I-7000/M-7000/ET-7000). In this configuration, XP-8000 expands the I/O very easily. Using CAN communication module, XP-8000 can connect CAN bus devices, remote I/O units for deterministic control system.

### 2 Embedded OS

#### • Windows Embedded Standard (WES)

Most of the popular features in Windows software are included, such as EWF (Enhanced Write Filter), Remote Desktop Connection, IIS, ASP/ASP.NET, SQL Server 2005 Express Edition, .NET Framework 3.5 and also supports rich development software solutions, such as VS 6.0, VS.NET 2005/2008, VB, Delphi, BCB, InduSoft.

#### • Windows CE6

Windows CE 6 is a compact and real-time OS used to quickly create time critical and high performance applications. With Windows CE 6, users can use familiar tools (VS .NET 2005/2008) to develop software. Its kernel architecture supports significantly more simultaneously running processes, from 32 up to 32,000 simultaneous processes, each of which can run in a 2GB virtual memory address space. This allows developers to incorporate larger numbers of more complex applications into the XP-8000-CE6. Further more, the development tools of Soft PLC (Win-GRAF) and SCADA (InduSoft) are also available.

**Appearance:**

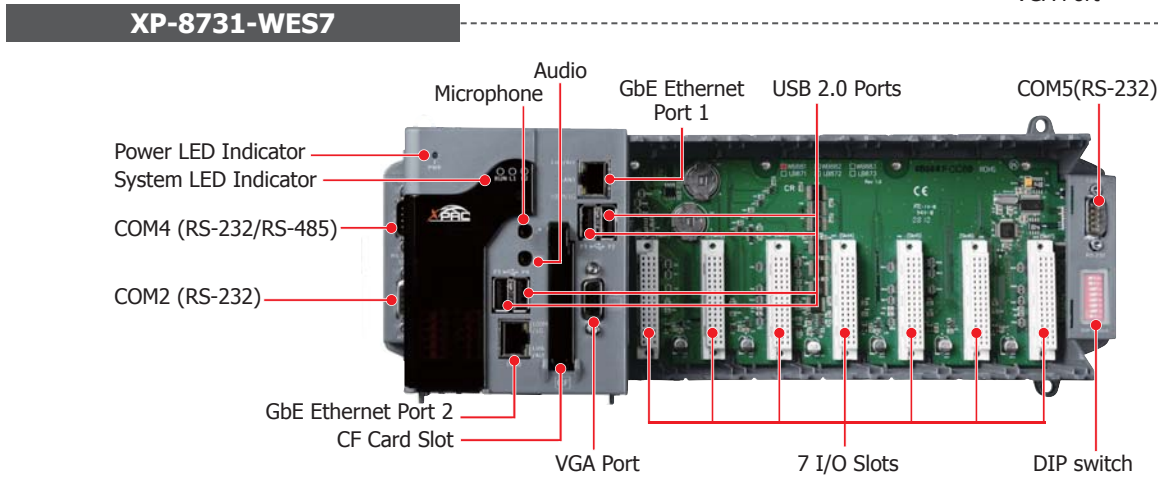
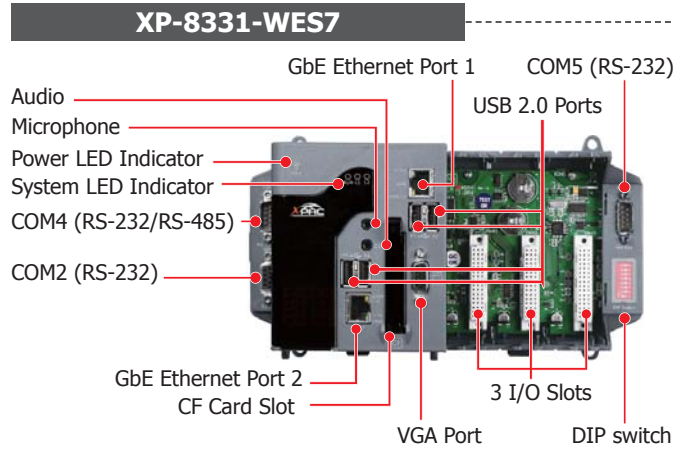
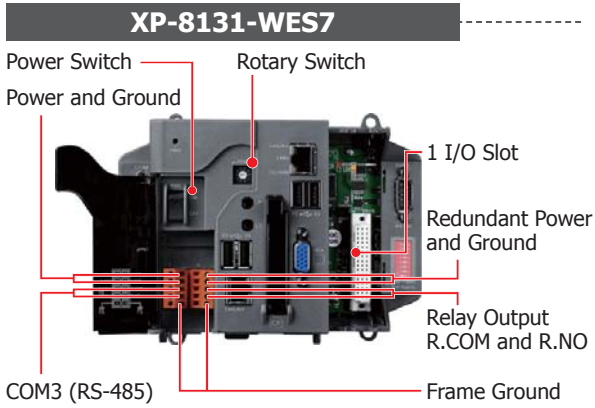

**Selection Guide:**

**XP-8**



**NO. of I/O Slot**



**CPU**  
 3: x86 CPU, 1 GHz  
 4: LX800  
 7: E3827



**Software**  
 1: Standard

**- OS**



**Standard XPAC**



Model Name	OS	CPU	Flash	SDRAM	VGA Resolution	Ethernet Port	RS-232/RS-485	I/O Slot
XP-8171-WES7	Windows Embedded Standard 7	E3827 1.75 GHz, dual core	32 GB	2 GB DDR3	1600 × 1200	2	4	1
XP-8371-WES7								3
XP-8771-WES7								7
XP-8131-WES7		x86 CPU, 1 GHz, dual-core						1
XP-8331-WES7								3
XP-8731-WES7								7
XP-8041	WES 2009	LX800, 500 MHz	4 GB	1 GB DDR			5	0
XP-8341							4	3
XP-8741							4	7

# XP-8



**NO. of I/O Slot**



**CPU**  
3: x86 CPU, 1 GHz  
4: LX800



**Software**  
1: Standard  
7: ISaGRAF  
8: Win-GRAF  
9: InduSoft

# - CE6



**Standard XPAC**



Model Name	OS	CPU	Flash	SDRAM	VGA Resolution	Ethernet Port	RS-232/RS-485	I/O Slot
XP-8131-CE6	CE 6.0	x86 CPU, 1 GHz, dual-core	32 GB	2 GB DDR3	1024 × 768	2	4	1
XP-8331-CE6								3
XP-8731-CE6								7
XP-8041-CE6		LX800, 500 MHz	4 GB	512 MB DDR			5	0
XP-8341-CE6							4	3
XP-8741-CE6							4	7



**Win-GRAF Based XPAC**



Model Name	OS	CPU	Flash	SDRAM	VGA Resolution	Ethernet Port	RS-232/RS-485	I/O Slot
XP-8138-CE6	CE 6.0	x86 CPU, 1 GHz, dual-core	32 GB	2 GB DDR3	1024 × 768	2	4	1
XP-8338-CE6								3
XP-8738-CE6								7
XP-8048-CE6		LX800, 500 MHz	4 GB	512 MB DDR			5	0
XP-8348-CE6							4	3
XP-8748-CE6							4	7



**ISaGRAF Based XPAC**



Model Name	OS	CPU	Flash	SDRAM	VGA Resolution	Ethernet Port	RS-232/RS-485	I/O Slot
XP-8047-CE6	CE 6.0	LX800, 500 MHz	32 GB	2 GB DDR3	1024 × 768	2	4	0
XP-8347-CE6								3
XP-8747-CE6								7



**InduSoft Based XPAC**



Model Name	OS	CPU	Flash	SDRAM	VGA Resolution	Ethernet Port	RS-232/RS-485	I/O Slot
XP-8139-CE6	CE 6.0	x86 CPU, 1 GHz, dual-core	32 GB	2 GB DDR3	1024 × 768	2	4	1
XP-8339-CE6								3
XP-8739-CE6								7
XP-8049-CE6	CE 6.0	LX800, 500 MHz	4 GB	512 MB DDR			5	0
XP-8349-CE6							4	3
XP-8749-CE6							4	7





# 1.3 WinPAC-8000 Series

## Introduction:



WinPAC-8000 is the new generation PAC of ICP DAS. It is equipped a ARM CPU running a Windows CE.NET operating system, various connectivities (VGA, USB, Ethernet, RS-232/485) and 1/4/8 slots for high performance Parallel I/O modules (high profile I-8K series) and serial I/O modules (high profile I-87K I/O modules).

WinPAC operating system, Windows CE, has many advantages, including hard real-time capability, small core size, short boot time, interrupt handling at a deeper level, achievable deterministic control, and low cost. Using Windows CE.Net in the WinPAC-8000 gives it the ability to run PC-based Control software such as Visual Basic.NET, Visual C#, Embedded Visual C++, SCADA software, SoftPLC.

## Main Components:

### 1 Main Control Unit (MCU)

The MCU is the powerhouse of the WinPAC-8000. Each MCU comprises a Central Processor Module (CPM), a power supply, and a 1, 4, 8-slot backplane for 1, 4, 8 I/O modules. The CPM is powerful integrated processing engine comprising a CPU, RAM and ROM, and an option of communication interfaces including Ethernet, RS-485, and CAN bus.

### 2 Embedded OS

All WinPAC have Windows CE OS inside, and most of the popular features in MS software are included, such as FTP Server, HTTP Server, ASP (Java/VB script), SQL Server embedded 3.5 and compact .NET Framework 3.5. WinPAC supports rich software & development solutions: VB.Net 2005/2008, Visual C#.NET 2005/2008, eVC++ 4.0, WinGRAF, ISaGRAF, InduSoft.

### 3 I/O Modules

There are two types of I/O communication bus, parallel bus and serial bus. The parallel bus type I/O modules (high profile I-8K series) are high speed ones used only in the PACs including XPAC, WinPAC, iPAC, ViewPAC, etc. And the serial bus type I/O modules (high profile I-87K series) are low speed ones used in both PACs including XPAC, WinPAC, iPAC, ViewPAC, etc., and I/O expansion units including RU-87Pn, ET-87Pn, USB-87Pn, etc.

### 4 Remote I/O Expansion

WinPAC uses built-in RS-485 and Ethernet ports to connect RS-485/Ethernet remote I/O units (Ru-87Pn/ET-87Pn) or modules (I-7000/M-7000/ET-7000). In this configuration, WinPAC expands the I/O very easily. Using CAN communication module, WinPAC can connect CAN bus devices, remote I/O units for deterministic control system.

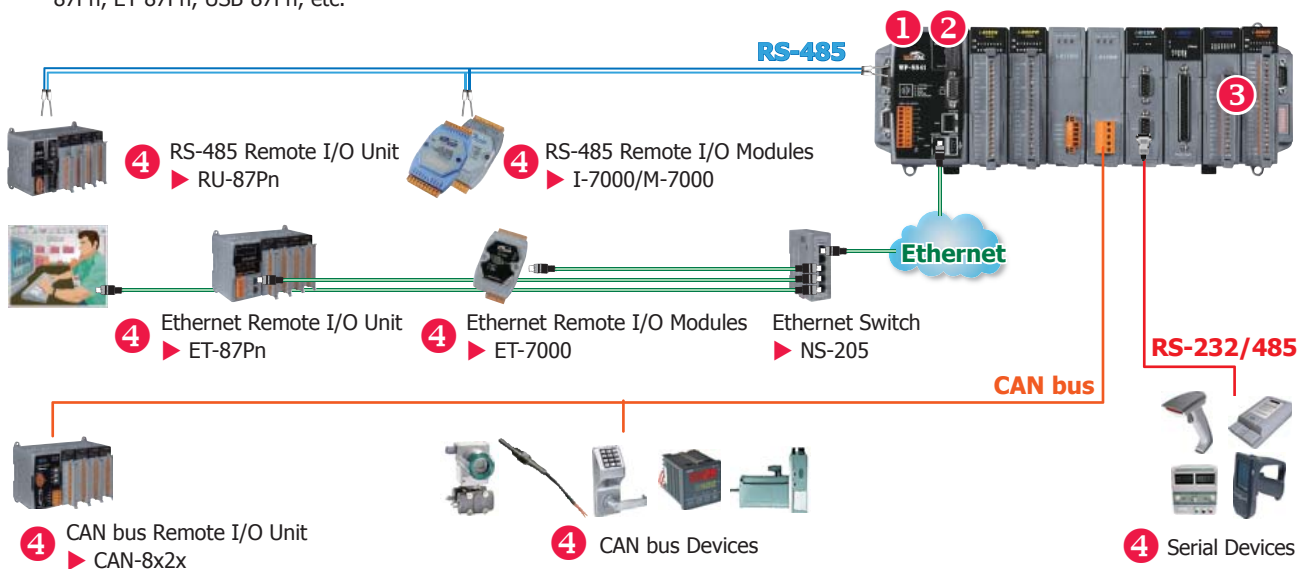

## Selection Guide:

# WP-8



NO. of I/O Slot



CPU

2: Cortex-A8, 1 GHz  
3: Cortex-A9  
4: PXA270, 520 MHz



Software

1: Standard  
7: ISaGRAF  
8: Win-GRAF  
9: InduSoft

# - CE7



Standard WinPAC



Model Name	OS	CPU	Flash	SDRAM	VGA Resolution	USB	RS-232/RS-485	I/O Slot	Memory Expansion
<b>New WP-8121-CE7</b>	CE 7.0	Cortex-A8, 1 GHz	256 MB	512 MB DDR3	1024 × 768	2	2	1	microSD
<b>New WP-8421-CE7</b>							4	4	
<b>New WP-8821-CE7</b>							4	8	
<b>WP-8141</b>	CE 5.0	PXA270, 520 MHz	96 MB	128 MB	800 × 600	1	2	1	microSD
<b>WP-8441</b>							4	4	
<b>WP-8841</b>							4	8	



Win-GRAF Based WinPAC



Model Name	OS	CPU	Flash	SDRAM	VGA Resolution	USB	RS-232/RS-485	I/O Slot	Memory Expansion
<b>New WP-8128-CE7</b>	CE 7.0	Cortex-A8, 1 GHz	256 MB	512 MB DDR3	1024 × 768	2	2	1	microSD
<b>New WP-8428-CE7</b>							4	4	
<b>New WP-8828-CE7</b>							4	8	
<b>WP-8148</b>	CE 5.0	PXA270, 520 MHz	96 MB	128 MB	800 × 600	1	2	1	microSD
<b>WP-8448</b>							4	4	
<b>WP-8848</b>							4	8	



ISaGRAF Based WinPAC



Model Name	OS	CPU	Flash	SDRAM	VGA Resolution	USB	RS-232/RS-485	I/O Slot	Memory Expansion
<b>WP-8147</b>	CE 5.0	PXA270, 520 MHz	96 MB	128 MB	800 × 600	1	2	1	microSD
<b>WP-8447</b>							4	4	
<b>WP-8847</b>							4	8	



InduSoft Based WinPAC



Model Name	OS	CPU	Flash	SDRAM	VGA Resolution	USB	RS-232/RS-485	I/O Slot	Memory Expansion
<b>New WP-8129-CE7</b>	CE 7.0	Cortex-A8, 1 GHz	256 MB	512 MB DDR3	1024 × 768	2	2	1	microSD
<b>New WP-8429-CE7</b>							4	4	
<b>New WP-8829-CE7</b>							4	8	

# 1.4 LinPAC-8000 Series

## Introduction:



The LinPAC-8000 is a second generation Linux-based PAC from ICP DAS and is equipped with a ARM CPU or x86 CPU running a Linux kernel 2.6 or above operating system, multiple communication interfaces (VGA, USB, Ethernet and RS-232/485) and 1/4/8-slot or 0/3/7-slot backplane for both high performance Parallel I/O modules (high profile I-8K series) and Serial I/O modules (high profile I-87K series).

The LinPAC-8000 gives users all of the best features of both traditional PLCs and Windows capable PCs. The LinPAC-8000 includes a VGA port allowing users to choose a regular LCD monitor for display of HMI application, USB port to connect with Keyboard, Mouse, USB device for storage or touch monitor, microSD/microSDHC memory for storage of program and data.

## Main Components:

### 1 Main Control Unit (MCU)

The MCU is the powerhouse of the LinPAC Series. Each MCU comprises a Central Processor Module (CPM), a power supply, and a 1, 4, 8-slot or 0, 1, 3, 7-slot backplane for I/O modules. The CPM is powerful integrated processing engine comprising a CPU, RAM and ROM, and an option of communication interfaces including Ethernet, RS-485, and CAN bus.

### 3 Embedded OS

All LinPAC have Linux kernel 2.6 or above OS inside, most of the popular features in Linux are included, such as open source, stability. LinPAC supports for rich software & development solutions: LinPAC SDK, GNU C Language, GUI software.

### 3 I/O Modules

There are two types of I/O communication bus, parallel bus and serial bus. The parallel bus type I/O modules (high profile I-8K series) are high speed ones used only in the PACs including XPAC, WinPAC, iPAC, ViewPAC, etc. And the serial bus type I/O modules (high profile I-87K series) are low speed ones used in both PACs including XPAC, WinPAC, iPAC, ViewPAC, etc., and I/O expansion units including RU-87Pn, ET-87Pn, USB-87Pn, etc.

### 4 Remote I/O Expansion

LinPAC uses built-in RS-485 and Ethernet ports to connect RS-485/Ethernet remote I/O units (RU-87Pn/ET-87Pn) or modules (I-7000/M-7000/ET-7000). In this configuration, LinPAC expands the I/O very easily. Using CAN communication module, LinPAC can connect to CAN bus devices, remote I/O units for deterministic control system.

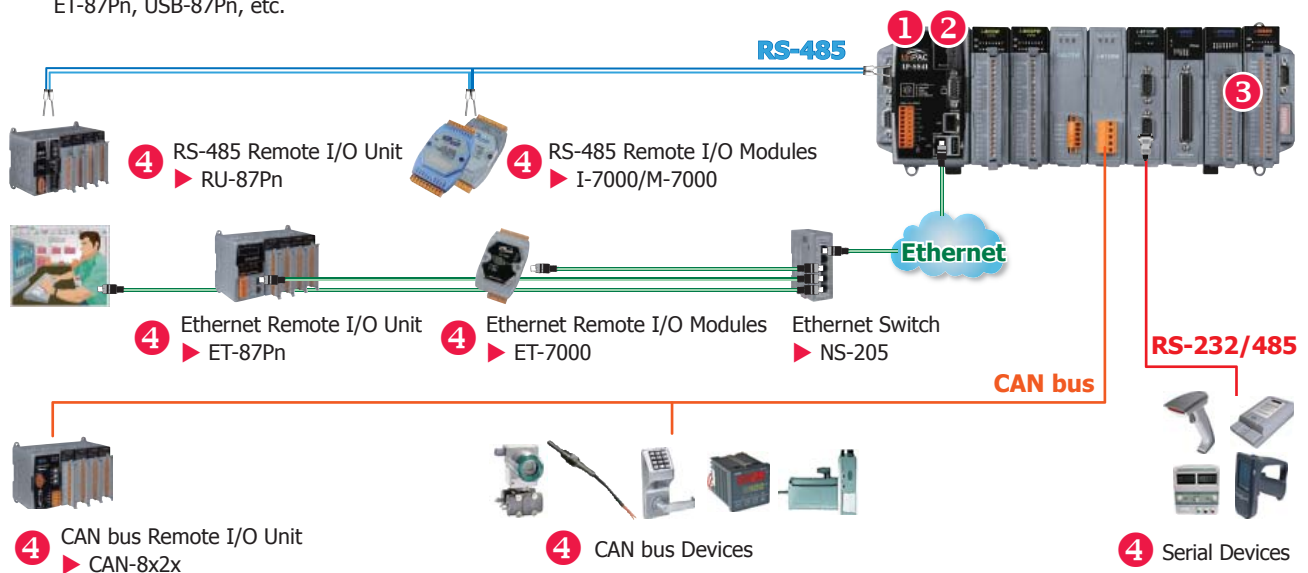



## Appearance:

### LP-8821

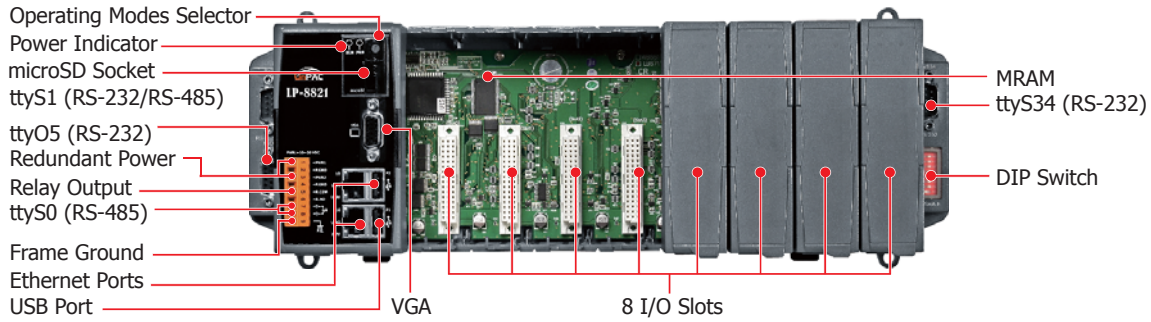

### LX-8131

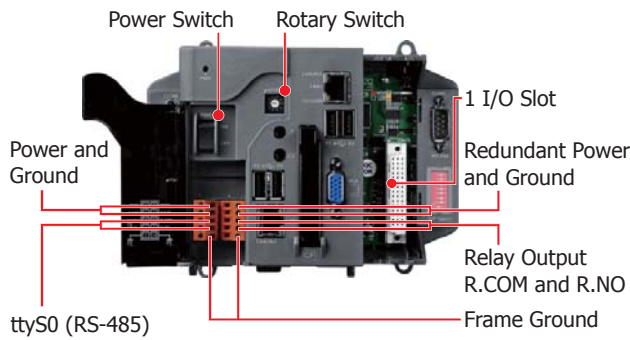

### LX-8331

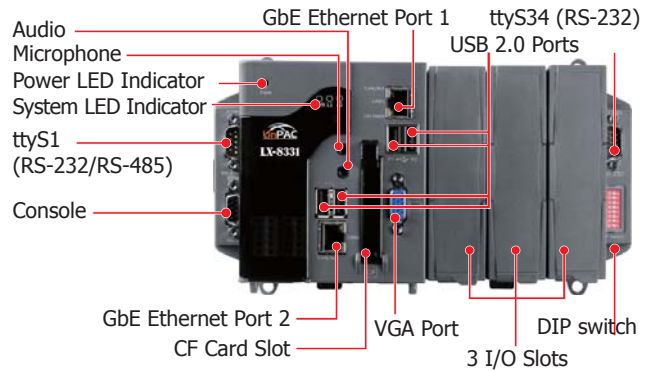

## Selection Guide:

LP - 8  
 LX

**X**  
 NO. of I/O Slot

**X**  
**CPU**  
 2: Cortex-A8, 1 GHz  
 3: x86 CPU, 1 GHz, dual-core  
 4: PXA270, 520 MHz  
 7: E3827  
 8: LX800, 500 MHz

**X**  
**Software**  
 1: Standard



Standard LinPAC



Model Name	OS	Software	CPU	Flash	SDRAM	Ethernet	VGA Resolution	RS-232/RS-485	I/O Slot	Audio Port
<b>New LP-8121</b>	Linux kernel 3.2	None	Cortex-A8, 1 GHz	512 MB	512 MB DDR3	2	1280 × 1024	2	1	None
<b>New LP-8421</b>								4	4	
<b>New LP-8821</b>								4	8	
<b>LP-8141</b>	Linux kernel 2.6	None	PXA270, 520 MHz	96 MB	128 MB	2	800 × 600	2	1	None
<b>LP-8441</b>								4	4	
<b>LP-8841</b>								4	8	
<b>New LX-8171</b>	Linux kernel 4.4	None	E3827	32 GB	2 GB DDR3	2	1920 × 1080	2	1	None
<b>New LX-8371</b>								4	3	
<b>New LX-8771</b>								4	7	
<b>New LX-8131</b>	Linux kernel 3.2	None	x86 CPU, 1 GHz, dual-core	32 GB	2 GB DDR3	2	1920 × 1080	2	1	None
<b>New LX-8331</b>								4	3	
<b>New LX-8731</b>								4	7	
<b>LP-8081</b>	Linux kernel 2.6	None	LX800, 500 MHz	4 GB	1 GB DDR SDRAM	2	1920 × 1080	5	0	None
<b>LP-8381</b>								4	3	
<b>LP-8781</b>								4	7	

# 1.5 iPAC-8000 Series

## Introduction:

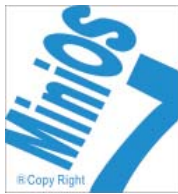

The iPAC-8000 is a family of compact, modular, intelligent and rugged, distributed PAC designed for data acquisition and control in manufacturing, research and education.

The iPAC-8000 is a modular network-based PAC with the capability of connecting I/O either through its own dual backplane bus or alternatively through remote I/O units and remote I/O modules. The unit comprises a main control unit

with a range of standard communication interfaces, and a dual backplane bus permitting I/O expansion.

The dual backplane bus is hybrid in nature providing the facility to connect either serial or parallel I/O modules. The parallel bus is used for high speed data transfer.

The unit can communicate using serial communications (RS-232, RS-485), Ethernet, or CAN bus. The Ethernet version of the product supports an integrated web server permitting Internet and Intranet applications.

The iPAC-8000 can be used as an intelligent distributed data acquisition front end connected to a host machine running a standard SCADA package, or alternatively. It can be programmed as an autonomous controller running an embedded software application. Significant non-volatile memory is available for data and program storage.

## Main Components:

### 1 Main Control Unit (MCU)

The MCU is the power house of the iPAC-8000. Each MCU comprises a central processor module (CPM), a power supply, a four (4) or eight (8) slot backplane for either 4 or 8 Parallel I/O modules. The CPM is a powerful integrated processing engine comprising a CPU, RAM and ROM, and an option of communication interfaces including RS-485, Ethernet, and CAN bus.

### 2 Embedded OS

All iPAC is equipped MiniOS7 embedded OS. It is developed by ICP DAS Co., Ltd and compatible to DOS. MiniOS7 has more features than regular DOS in embedded applications, such as shorter boot time, built-in hardware diagnostic function, directly support I-8000 and I-7000 modules without library, and directly support Micro SD and Flash disk.

### 3 I/O Modules

There are two types of I/O communication bus, parallel bus and serial bus. The parallel bus type I/O modules (high profile I-8K series) are high speed ones used only in the PACs including XPAC, WinPAC, iPAC, ViewPAC, etc. And the serial bus type I/O modules (high profile I-87K series) are low speed ones used in both PACs including XPAC, WinPAC, iPAC, ViewPAC, etc., and I/O expansion units including RU-87Pn, ET-87Pn, USB-87Pn, etc.

### 4 Remote I/O Expansion

The iPAC-8000 uses built-in RS-485 and Ethernet ports to connect RS-485/Ethernet remote I/O units (RU-87Pn/ET-87Pn) or modules (I-7000/M-7000/ET-7000). In this configuration, iPAC expands the I/O very easily. Using CAN communication module, iPAC can connect CAN bus devices, remote I/O units for deterministic control system.

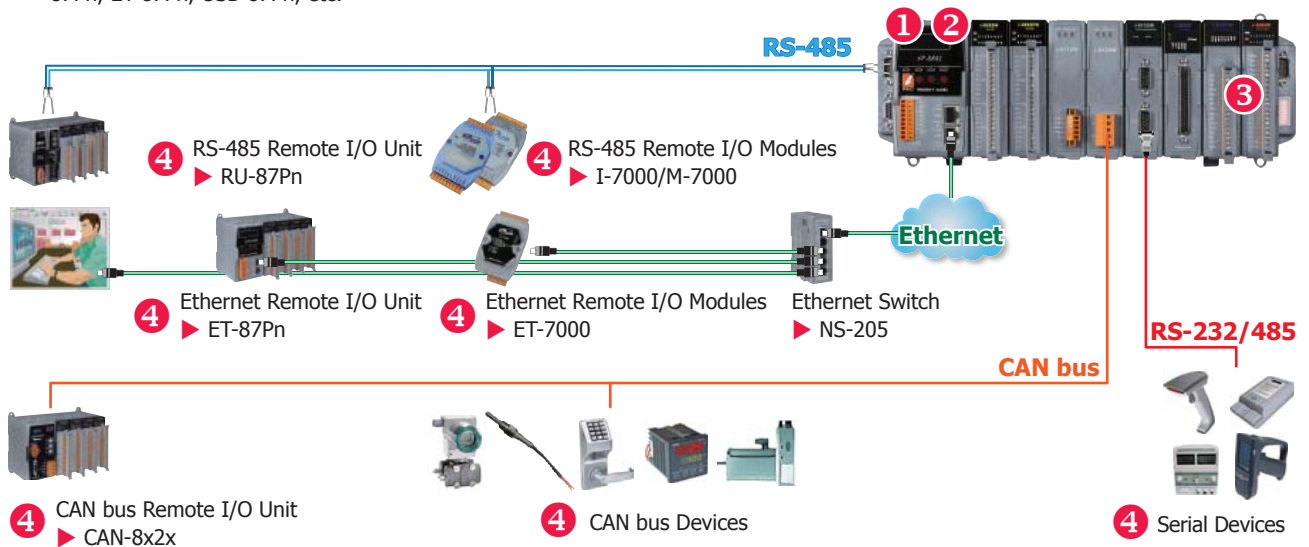

## Appearance:

iP-8841/iP-8841-FD/iP-8847

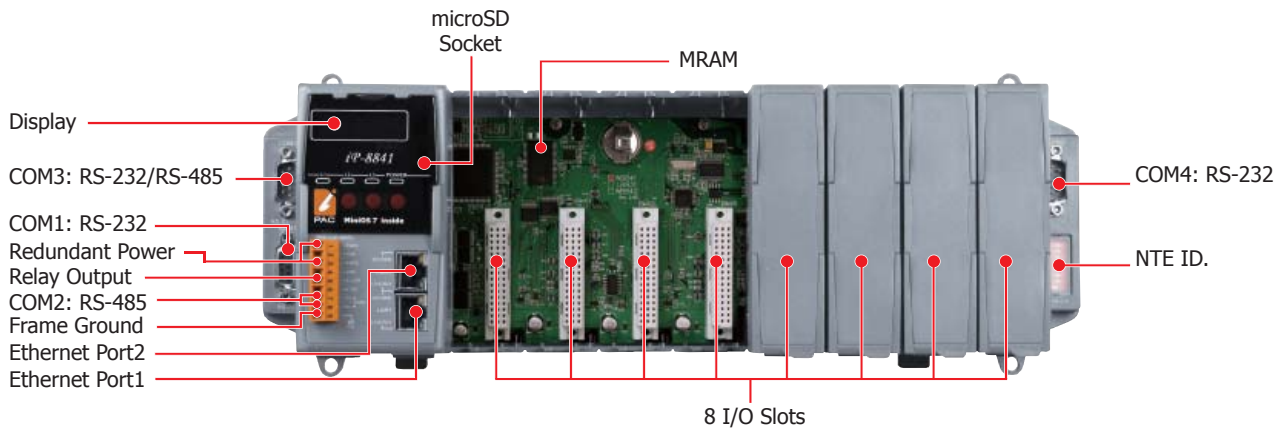

## Selection Guide:

# iP- 8

**X**  
NO. of I/O Slot

**X**  
**Hardware**  
1: Without Ethernet  
3: Ethernet × 1  
4: Ethernet × 2

**X**  
**Software**  
1: Standard  
7: ISaGRAF

**XX**  
**Flash Disk**  
FD: 512 MB Flash Disk

Standard iPAC 

Model Name	Pre-installed Software	CPU	Flash	512 MB Flash Disk	SRAM	Ethernet Port	RS-232/RS-485	I/O Slot	Power Consumption
iP-8411	None	80 MHz	512 KB	-	512 KB	-	4	4	6.7 W
iP-8811								8	7.2 W
iP-8441								4	6.7 W
iP-8841								8	7.2 W
iP-8441-FD				Yes	768 KB	2 (10/100 BaseTx)	4	4	6.7 W
iP-8841-FD								8	7.2 W

The controller is equipped with a DOS-like OS, called MiniOS7. Users can use C compilers to develop a program in 16 bit executable file (\*.exe), then download it to the controller. There are many demo programs. For TCP/IP programming, ICP DAS provides a TCP/IP server template XServer which is a very powerful, easy-to-use and flexible tool saving 90% development time.

ISaGRAF Based iPAC 

Model Name	Pre-installed Software	CPU	Flash	512 MB Flash Disk	SRAM	Ethernet Port	RS-232/RS-485	I/O Slot	Power Consumption		
iP-8417	ISaGRAF	80 MHz	512 KB	-	512 KB	-	4	4	6.7 W		
iP-8817								8	7.2 W		
iP-8447								2 (10/100 BaseTx)	4	4	6.7 W
iP-8847										8	7.2 W

The controller fully supports all five of the IEC61131-3 standard PLC languages:

1. Ladder diagram,
2. Function block diagram,
3. Sequential function chart,
4. Structured text,
5. Instruction List plus flow chart.

It supports Modbus protocol and can link to distributed I/O modules with Modbus or DCON protocol via the RS-232/485 or Ethernet.



# 1.6 Industrial I/O Modules

## Introduction:

There are two types of I/O modules, parallel and serial. Both type of the modules can be plugged into the slots of PAC series. But only the serial module can be used in remote I/O units, such as RU-87Pn and ET-87Pn. Up to now, over 100 I/O, communication and motion control modules are available. For the new generation PACs, only the high profile I-8KW and I-87KW I/O modules can be used.

### 1 Parallel I/O Modules (I-8KW Series) Includes

- High speed A/D: 100 k samples/second
- High speed D/A: 30 k (-10 ~ +10 V)
- High speed DI & DO: All Digital I/O modules provide visual indication of status via LED indicators
- High speed stepping/Servo motion control modules
- High speed encoder modules
- High performance Counter/Frequency modules
- High speed multi-channel RS-232/422/485 modules
- CAN bus communication modules

### 2 Serial I/O modules (I-87KW Series) Includes

- RTD Input modules
- Thermocouple Input modules
- Strain Gauge Input modules
- VW Input modules
- High resolution multi-channel Analog Input modules
- Isolated multi-channel D/A modules
- Digital Input and Digital Output modules with Latch and counter function
- Counter/Frequency modules



### 3 Comparison Table of I-8KW Series and I-87KW Series

Item	I-8KW Series	I-87KW Series	I-87KW Series
Communication Interface	Parallel bus	Parallel bus	Serial bus
Protocol	-	-	DCON
DI with latched function	-	-	Y
DI with counter input	-	-	Y (100 Hz)
Power on value	-	Y	Y
Safe value	-	Y	Y
Programmable slew-rate for AO module	-	-	Y

### 4 Supporting I/O Module list of MCU (Main Control Unit) and I/O expansion unit:

Item	I-8K Series		I-87K Series	
	High Profile	Low Profile	High Profile	Low Profile
XPAC	Y	-	Y	-
WinPAC	Y	-	Y	-
LinPAC	Y	-	Y	-
iPAC	Y	-	Y	-
ViewPAC	Y	-	Y	-
RU-87P1/2/4/8	-	-	Y	-
USB-87P1/2/4/8	-	-	Y	-
ET-87P4/8	-	-	Y	-
I-8KE4/8	Y	Y	Y	Y
I-8KE4/8-MTCP	Y	Y	Y	Y
I-87K4/5/8/9	-	-	Y	Y

## 5 Hot features

### Dual Watchdog Operation

The I-87K I/O modules include an internal Dual Watchdog. It is the combination of module watchdog and host watchdog. The module watchdog is a hardware watchdog designed to reset the micro-controller of the module when the module fails. This mechanism can keep the module work continuously without disruption. The host watchdog is a software watchdog that monitors the operating status of the PAC. When the PAC fails, the outputs of the module will be set to the safe values to prevent any erroneous operations. With Dual Watchdog, the control system is more reliable and stable.

### Power On Value and Safe Value of Digital/Analog Output

Besides setting by the set digital/analog output commands, the digital/analog outputs can be set under two other conditions. When the host watchdog is enabled and a host watchdog timeout occurs, the "safe value" is loaded into the digital/analog output ports. The set digital/analog output commands have no effect on the digital/analog output ports until the host watchdog timeout status is cleared. The host watchdog timeout status is saved in the EEPROM. The status is not changed even after power-on reset. It can be cleared only by the reset host watchdog timeout status command  $\sim$ AA1. See Section A.2 for host watchdog details.

When the module is powered on and the host watchdog timeout status is cleared, the "power-on value" is loaded into the digital/analog output ports. If the host watchdog timeout status is not cleared on power-on, then the safe value is loaded into the digital/analog output ports. Both the safe value and power-on value are set by the  $\sim$ AA5V command.

### Advanced DI Functions of I-87K Series I/O Modules

DI channel is not only for reading digital input status but also provides several advanced functions in the meanwhile.

#### • DI Latch Function

All DI channels provide Latch function to keep the high/low events in the internal registers of the module. In general, the host controller polls modules one by one to get all DI status. Because RS-485 is a low speed field bus, the polling will take time and probably miss a short duration signal. With the DI latch function, the short duration ( $\geq 5\text{ms}$ ) signal will not be lost any more.

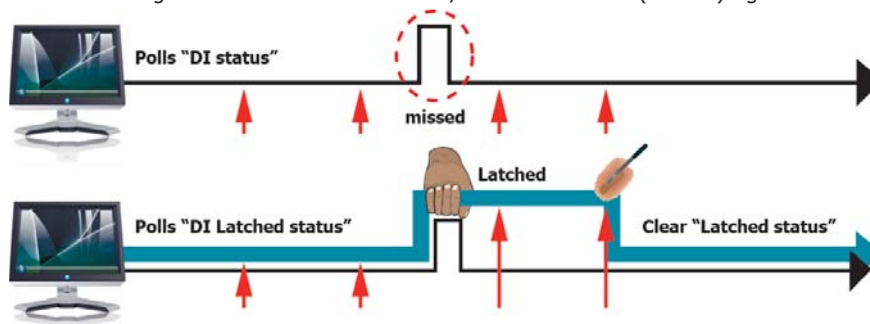

#### • Low Speed Counter

The DI module automatically counts the DI signal in the background. The signal under 100Hz can be detected and counted.



### Overvoltage Protection

Many of our analog input modules provide high overvoltage protection for the analog input channels. When user picks wrong line accidentally or high voltage spike is applied to the analog input terminals, the module will not be broken and can still get the correct readings. This feature improves the reliability, reduces maintenance frequency, and makes the whole system more robust.

### Open Wire Detection

The thermocouple, RTD and thermistor sensors are widely used in temperature control applications. If the system can not monitor the open wire status of the sensors, it may be very dangerous and cause large damage to life and property. When the wire of sensor is broken and the controller does not know the open wire status, the system may heat the boiler continuously and result in fire or explosion. Our thermocouple, RTD, thermistor modules provide open wire detection and make the system safer.

### Over-current Protection

For the current measurement module, it may be damaged when there is high current or voltage introduced into the current loop. The protection for current measurement is improved to  $\pm 120\text{ VDC}$  and  $\pm 1000\text{ mA}$ . A high current or voltage in the current loop will not damage the current measurement, so the whole system can work normally.

### Virtual Channel to Channel Isolation

The "R" and "Z" version of analog input modules provide  $\pm 400\text{ VDC}$  virtual channel to channel isolation to avoid the noise interference from adjacent channel in the industrial environment. To name a few of the modules, they are I-87017RW, I-87017ZW, I-87018RW, I-87018ZW, I-87019RW, and I-87019ZW. Though it is not real channel to channel isolation, there is only  $1\mu\text{A}$  leakage current between two adjacent channels and the interference is very small and can be negligible.

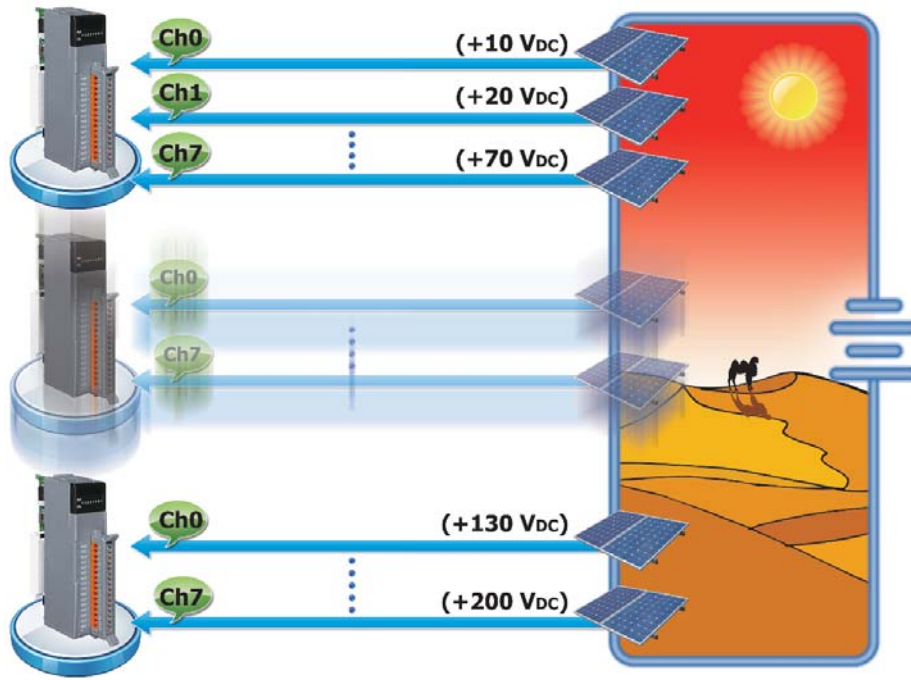

**Common Voltage Protection**

The typical application is to monitor the charging status of the batteries in series. The voltage of each battery is +10 VDC so the first battery is +10 VDC, the second battery is +20 VDC etc. The differential voltage of the 20th battery is only +10 VDC between vin+ and vin- terminal, while the common voltage is up to 200 VDC. If the common voltage of the analog input module is not large enough, then it can not measure the correct voltage of the battery in charging. ICP DAS analog input modules provide ±200 VDC high common voltage for industrial applications.

**ESD Protection**

In the industrial environment there are many noise, spike, electrostatic etc.. If the module is not strong enough, it is very easy to be damaged. The I-8KW and I-87KW modules all pass ±4 KV ESD contact and ±8 KV ESD air tests by static electricity gun in our laboratory. The test procedures follow the IEC 61000-4-2 standard. Our modules are immunity to the electrostatic discharges by using components that can clamp and resist to the high voltages defined by IEC 61000-4-2 standard.

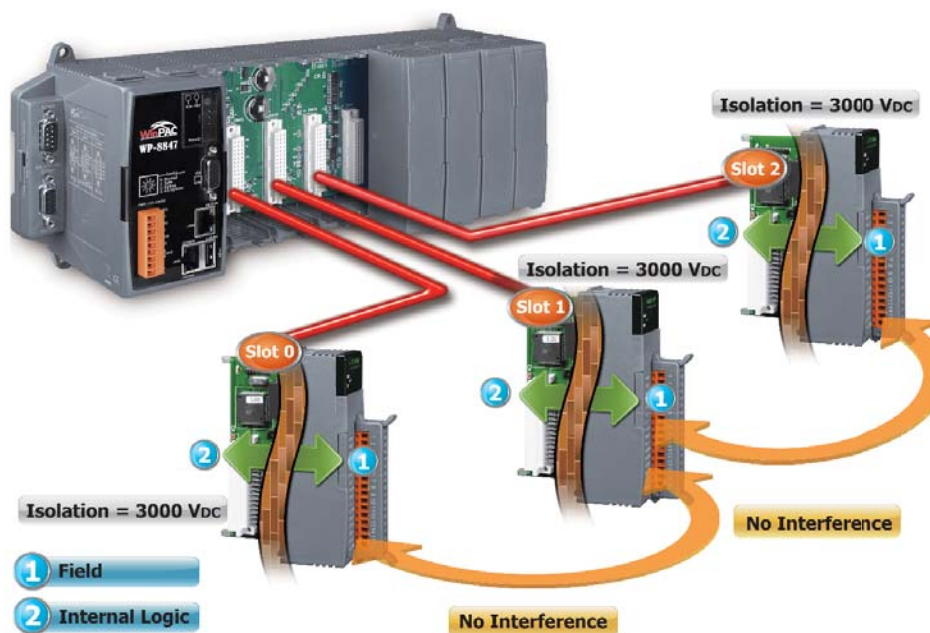
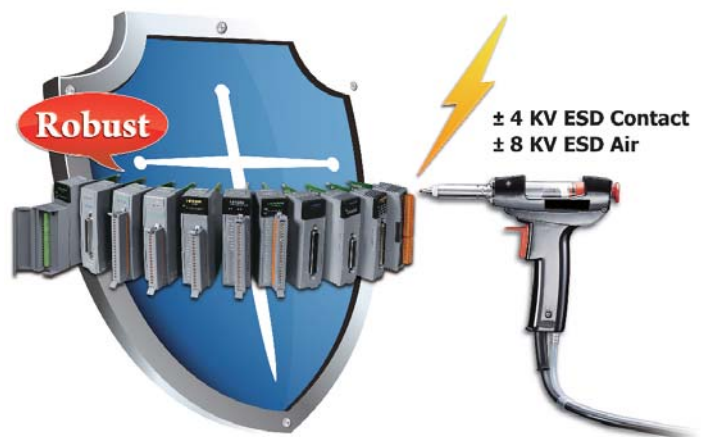

**3000 VDC Isolation**

The I-8K and I-87K series have 3000 Vdc isolation between the field and the internal logic. This isolation prevents the noise from the field to the internal logic that can damage the module. It is recommended to choose isolated modules that will be plugged into controller. There will be no interference from the adjacent slot because the noise from the adjacent slot is isolated.



# Analog Modules



## Analog Input Modules



Model Name	Bus	Analog Input			
		Channels	Input Range	Sensor	
I-87004W (*1)	Serial	4	-	DS18B20 (-55 ~ +125°C)	
I-87005W (*2)		8	-	Thermistor	
I-87013W		4	-	RTD: Pt100, Pt1000, Cu50, Ni120	
I-87015W		7	-	RTD: Pt100, Pt1000, Cu50, Cu100, Cu1000, Ni120	
I-87015PW					
I-8014W	Parallel	8/16	±10 V, ±5 V, ±2.5 V, ±1.25 V, ±20 mA (with external 125 Ω resistor)	-	
I-8017HW		8/16	±10 V, ±5 V, ±2.5 V, ±1.25 V, ±20 mA (with external 125 Ω resistor)	-	
I-8017HCW		8/16	±10 V, ±5 V, ±2.5 V, ±1.25 V, ±20 mA (jumper)	-	
I-87017W	Serial	8	±10 V, ±5 V, ±1 V, ±0.5 V, ±150 mV, ±20 mA, 4 ~ 20 mA (with external 125 Ω resistor)	-	
I-87017DW		8/16			
I-87017RW		8			
I-87017ZW		10/20	±10 V, ±5 V, ±1 V, ±0.5 V, ±150 mV, ±20 mA, 4 ~ 20 mA (jumper)	-	
I-87017W-A5		8	±50 V, ±150 V	-	
I-87017W-RMS		8	0 ~ +10 Vrms, 0 ~ +5 Vrms, 0 ~ 1 Vrms, 0 ~ 500 mVrms, 0 ~ 150 mVrms	-	
I-87017RCW		8	0 ~ 20 mA, +4 ~ 20 mA, ±20 mA	-	
I-87017MC-16		16	0 ~ 20 mA, +4 ~ 20 mA, ±20 mA (with 100,000 records for AI Data logger)	-	
I-87018W		8	±2.5 V, ±1 V, ±500 mV, ±100 mV, ±50 mV, ±15 mV, ±20 mA (with external 125 Ω resistor)	Thermocouple (J, K, T, E, R, S, B, N, C, L, M)	
I-87018RW					
I-87018PW			±2.5 V, ±1 V, ±500 mV, ±100 mV, ±50 mV, ±15 mV, ±20 mA, 0 ~ 20 mA, 4 ~ 20 mA		
I-87018ZW			10		(with external 125 Ω resistor)
I-87019PW			8		±2.5 V, ±1 V, ±500 mV, ±100 mV, ±50 mV, ±15 mV, ±20 mA, 0 ~ 20 mA, 4 ~ 20 mA (jumper)
I-87019RW	8				
I-87019ZW	10				

(\*1): I-87004 has 4 ports, each port can link 20x DS18B20, total 80 sensors

(\*2): I-87005 also includes 8 channel DO (Open Collector, sink, 700 mA)



## Analog Output Modules



Model Name	Bus	Analog Outputs				
		Channels	Resolution	Output Range	Wiring Current Output	channel to channel Isolation
I-87022W	Serial	2	12-bit	0 ~ 10 V, ±10 V, 0 ~ 20 mA, 4 ~ 20 mA	Sink	Yes, 3 kv
I-87024W		4	14-bit	0 ~ 5 V, ±5 V, 0 ~ 10 V, ±10 V, 0 ~ 20 mA, 4 ~ 20 mA		-
I-87024RW				12-bit		0 ~ 20 mA, 4 ~ 20 mA
I-87024DW			16-bit		0 ~ 5 V, ±5 V, 0 ~ 10 V, ±10 V, 0 ~ 20 mA, 4 ~ 20 mA	Source
I-87024CW				8	12-bit	0 ~ 20 mA, 4 ~ 20 mA
I-87024UW		16-bit	0 ~ 5 V, ±5 V, 0 ~ 10 V, ±10 V, 0 ~ 20 mA, 4 ~ 20 mA			Source
I-87028CW			12-bit		0 ~ 10 V	-
I-87028UW		0 ~ 20 mA, 4 ~ 20 mA				
I-87028VW		12-bit	0 ~ 20 V	-	-	
I-87028VW-20V			0 ~ 20 V			
I-8024W	Parallel	4	14-bit	±10 V, ±20 mA	Sink	-
I-8024DW						

# Digital Modules



Model Name	Bus	Digital Input			Digital Output				
		Channels	Contact	ON Voltage Level	Channels	Type	Sink/Source	Max. Load	
I-8040W	Parallel	32	Wet	10 ~ 30 VDC	-	-	-	-	
I-8040PW				19 ~ 30 VDC	-	-	-	-	
I-8046W		16	Dry	Connect to GND	-	-	-	-	
I-8048W (Note 1)		8	Dry + Wet	4 ~ 30 VDC	-	-	-	-	
I-8051W		16	Dry	Connect to GND	-	-	-	-	
I-8052W		8	Wet	10 ~ 30 VDC	-	-	-	-	
I-8053W		16			-	-	-	-	
I-8053PW		16			19 ~ 30 VDC	-	-	-	-
I-8053W-A1		16			3.5 ~ 30 VDC	-	-	-	-
I-8058W		8			80 ~ 250 VAC	-	-	-	-
I-87040W		Serial	32	Wet	10 ~ 30 VDC	-	-	-	-
I-87040PW	19 ~ 30 VDC				-	-	-	-	
I-87046W	16		Dry	Connect to GND	-	-	-	-	
I-87051W					-	-	-	-	
I-87052W	8		Wet	3.5 ~ 30 VDC	-	-	-	-	
I-87058W			AC, Differential	80 ~ 250 VAC	-	-	-	-	
I-87059W				10 ~ 80 VAC	-	-	-	-	
I-87053W	Serial		16	Dry + Wet	3.5 ~ 30 VDC	-	-	-	-
I-87053PW					19 ~ 30 VDC	-	-	-	-
I-87053W-A2					19 ~ 50 VDC	-	-	-	-
I-87053W-A5					68 ~ 150 VDC	-	-	-	-
I-87053W-AC1		Wet	10 ~ 80 VAC	-	-	-	-		
I-87053W-E5			68 ~ 150 VDC	-	-	-	-		
I-8037W	Parallel	-	-	-	16	Open Collector	Source	100 mA	
I-8041W		-	-	-	32		Sink	100 mA	
I-8041AW		-	-	-			Source	100 mA	
I-8057W		-	-	-	16	Open Collector	Sink	100 mA	
I-8057PW	-	-	-	700 mA					
I-87037W	Serial	-	-	-	16	Open Emitter	Source	700 mA	
I-87041W		-	-	-	32	Open Collector	Sink	100 mA	
I-87057W		-	-	-	16			100 mA	
I-87057PW		-	-	-	16			700 mA	
I-8042W	Parallel	16	Wet	10 ~ 30 VDC	16	Open Collector	Sink	100 mA	
I-8050W (Note 2)					100 mA				
I-8054W		8	700 mA						
I-8055W	8	Dry	Connect to GND	8	100 mA				
I-87042W	Serial	16	Wet	3.5 ~ 30 VDC	16	Open Collector	Sink	100 mA	
I-87054W					700 mA				
I-87055W		8	Dry	Connect to GND	8			100 mA	

Note 1 : I-8048W is a 8-ch digital input interrupt module.  
 Note 2 : I-8050W is a 16-ch universal digital input/output module.

## ➔ Multi-Function/Strain Gauge Modules



Model Name	Bus	Analog Inputs	Analog Outputs	Digital Inputs	Digital Outputs
I-87016W	Serial	2 (Strain Gauges) (Full-bridge, Half-bridge, Quarter-bridge)	2 (Voltage, Current)	2 (Wet, Sink)	2 (Open Collector, Sink)
I-87026PW	Serial	6 (Voltage, Current)			
I-8026W	Parallel				

## ➔ Relay Modules



Model Name	Bus	Channels	Type	Contact	Load Current
I-8060W	Parallel	6	Power Relay	Form C	0.5 A @ 125 VAC, 0.25 A @ 250 VAC, 2 A @ 30 VDC
I-8063W (*)		4	Power Relay	Form C	Form A: 5 A @ 250 VAC/30 VDC Form C: 3 A @ 250 VAC/30 VDC
I-8064W		8	Power Relay	Form A	5 A @ 250 VAC, 5 A @ 30 VDC
I-8068W		8	Power Relay	Form A × 4 Form C × 4	Form A: 5 A @ 250 VAC/30 VDC Form C: 3 A @ 250 VAC/30 VDC
I-8069W		8	PhotoMOS	Form A	1 A @ 60 VDC
I-87061W	Serial	16	Power Relay	Form A	5.0 A @ 250 VAC/30 VDC
I-87063W (*)		4	Power Relay	Form C	Form A: 5 A @ 250 VAC/30 VDC Form C: 3 A @ 250 VAC/30 VDC
I-87064W		8	Power Relay	Form A	5.0 A @ 250 VAC/30 VDC
I-87065W		8	AC SSR	Form A	1.0 A @ 265 VAC
I-87066W		8	DC SSR	Form A	1.0 A @ 30 VDC
I-87068W		8	Power Relay	Form A × 4 Form C × 4	Form A: 8 A @ 250 VAC/30 VDC Form C: 3 A @ 250 VAC/30 VDC
I-87069W		8	PhotoMOS	Form A	0.13 A, 350 V Max. at DC/AC
I-87069PW		8	PhotoMOS	Form A	1.0 A, 80 V Max. at DC/AC

(\*): I-8063W and I-87063W also have 4 DI (Wet contact, sink and source)

## ➔ Counter/Frequency/PWM Modules



Model Name	Bus	Counter/Frequency Input					PWM Output	
		Channels	Counter	Signal	Speed	Frequency Accuracy	Channels	Type
I-87082W	Serial	2	32-bit	Up	100 kHz	1 Hz	2	Open Collector
I-8084W	Parallel	4/8	32-bit	Up, CW/CCW, A/B, Pulse/Dir	250 kHz	0.1 Hz	-	-
I-87084W	Serial						-	-
I-8088W	Parallel	-	-	-	-	-	8	PWM Duty: 0.1 ~ 99.9% Freq: 1 ~ 500 KHz
I-87088W	Serial	8	32-bit	Up	1 MHz	-		



+3.5 to +50 V  
PWM Output



+3.5 to +50 V  
Counter Input

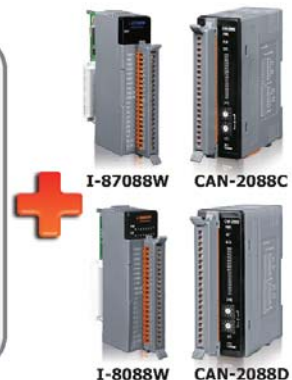
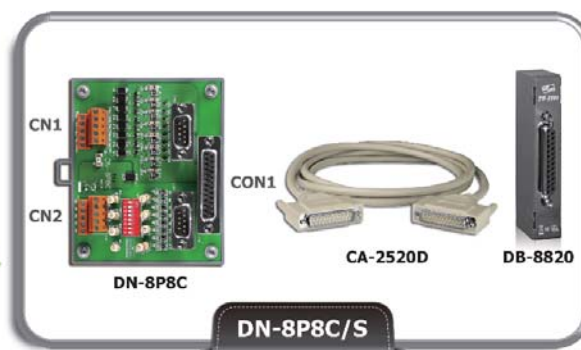



## ➔ Motion Control Modules



Model Name	Encoder Input				Command Pulse Output				Daughter Board	Other Functions
	Axis	Counter	Input Rate (pps)	Signal	Axis	Speed (pps)	Counter	Signal		
<b>I-8092F</b>	2	32-bit	4 M	CW/CCW, A/B	2	4 M	32-bit	CW/CCW, PULSE/DIR	DN-8237	FRnet Master
<b>I-8093W</b>	3	32-bit	1 M	CW/CCW, A/B, Pulse/Dir	-	-	-	-	-	-
<b>I-8094</b>	4	32-bit	4 M	CW/CCW, A/B	4	4 M	32-bit	CW/CCW, PULSE/DIR	DN-8468	-
<b>I-8094F</b>	4	32-bit	4 M	CW/CCW, A/B	4	4 M	32-bit	CW/CCW, PULSE/DIR	DN-8468	FRnet Master
<b>I-8196F</b>	6	32-bit	12 M	CW/CCW, A/B	6	12 M	32-bit	CW/CCW, PULSE/DIR	DN-8368	FRnet Master

**Daughter-Board for two-axis motion controller**

**DN-8237GB:** for general purpose usage  
**DN-8237MB:** for Mitsubishi servo J2 Amplifier  
**DN-8237YB:** for Yaskawa servo Amplifier  
**DN-8237DB:** for Delta ASDA A servo Amplifier  
**DN-8237PB:** for Panasonic servo minas A Amplifier

**DN-8237 Series**



Dimensions: 110 mm × 107 mm

**Daughter-Board for four-axis motion controller**

**DN-8468GB:** for general purpose usage  
**DN-8468MB:** for Mitsubishi servo J2 Amplifier  
**DN-8468YB:** for Yaskawa servo Amplifier  
**DN-8468DB:** for Delta ASDA A servo Amplifier  
**DN-8468PB:** for Panasonic servo minas A Amplifier  
**DN-8468FB:** for FUJI FALDIC-W servo Amplifier

**DN-8468 Series**



Dimensions: 162 mm × 107 mm

**Daughter-Board for six-axis motion controller**

**DN-8368GB:** for general purpose usage  
**DN-8368MB:** for Mitsubishi servo J2 Amplifier  
**DN-8368UB:** for universal snap -on usage

**DN-8368 Series**



Dimensions: 162 mm × 107 mm

## ➔ Serial Communication Modules



Model Name	Bus	Ports	Type	Isolation	Connector	Accessories
<b>I-8112iW</b>	Parallel	2	RS-232	2500 Vrms	2 × D-Sub9	CA-0915
<b>I-8114W</b>		4		-	D-Sub 37	CA-9-3705
<b>I-8114iW</b>		4		RS-232/485		
<b>I-8142iW</b>		2	-			
<b>I-8144iW</b>		4	-			



CA-0915



CA-9-3705

## ➔ CAN/CANopen/DeviceNet Master Modules



Model Name	Bus	Ports	Max Speed	Protocol
<b>I-8120W</b>	Parallel	1	1 Mbps	CAN 2.0A/2.0B
<b>I-8123W</b>				CANopen
<b>I-87123W</b>	Serial		500 Kbps	DeviceNet
<b>I-8124W</b>	Parallel			
<b>I-87124W</b>	Serial			

## HART Communication Modules

Model Name	Description
I-87H17W	HART Module with 8-ch analog inputs

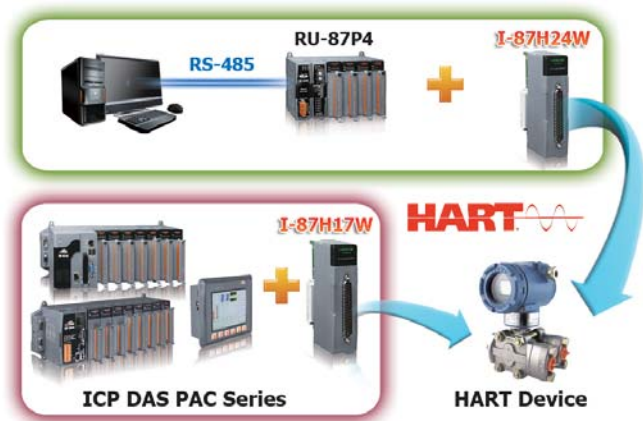

## 3G/4G/GPS Modules



Model Name	Frequency (MHz)	GPS Interface	Max. Download Speed	AT Command	TCP/IP Protocol
I-8212W-3GWA	2G (GSM/GPRS): 850/900/1800/1900 3G (UMTS/HSDPA/HSUPA): 2100/1900/850	-	9.6 ~ 115.2 Kbps	Yes	Yes
I-8213W-3GWA	2G (GSM/GPRS): 850/900/1800/1900 3G (UMTS/HSDPA/HSUPA): 2100/1900/850	Yes			
I-8213W-4GE	2G (GSM/GPRS): 850/900/1800/1900 3G (UMTS/DC-HSPA+): 850/900/2100 4G (FDD LTE): B1/B3/B5/B7/B8/B20	-	100 Mbps	-	-

Model Name	GPS Channels	SBAS	GPS Output Interface	GSM/GPRS	Digital Output	Protocol/Interface	Description
I-87211W	32	WAAS, EGNOS, MSAS	RS-232	-	2	DCON	GPS Receiver and 2 DO Module

## GPS Time Synchronization



Model Name	GPS Channels	SBAS	Acquisition Time	Cable Length of Antenna
I-8211W	32	WAAS, EGNOS, MSAS	Warm start = 2 seconds (typical) Cold start = 36 seconds (typical)	5 m

### Introduction:

The I-8211W is a GPS receiver that been designed to be automatically and precisely time synchronized for the GPS satellite time transmissions. The I-8211W can be plugged into either slot of the LinPAC, the LinPAC will automatically launch the application and get the GPS time to minimize the RTC drift to 1 millisecond.

PS: LinPAC with NTPD package: LP-8x21, LX-8x31

```
root@icpdas:~# ntpq -p
      remote           refid      st t when poll reach   delay   offset  jitter
=====
oGPS_NMEA(0)   .GPS.         0 1  15  64  377  0.000  -0.068  0.148
```

Time error < 1 ms

# 2. 7188/7186 Series $\mu$ PAC

## Introduction:



ICP DAS develops a family of palm-size PAC named  $\mu$ PAC (micro Programmable Automation Controller). Featuring robust, powerful, space-saving, cost-effective and more,  $\mu$ PAC presents excellent performance in various Industry Automation applications in the challenging environments.

### I-7188 — the 1st generation

"I-7188 Series", the first generation of  $\mu$ PAC, has been widely used in various Industry Automation applications. It is characterized by fast-booting operating system MiniOS7, interchangeable X-Board for function expansion, flexible COM port configuration and user-defined I/O pins.

### $\mu$ PAC-7186 — the 2nd generation

" $\mu$ PAC-7186 Series", debuting in 2008, further improves and upgraded features, such as faster CPU, better 10/100 Base-TX Ethernet port, lower power consumption and diversified Memory combination selections. With better performance, it is suitable for more sophisticated applications: auto-reporting data acquisition, M2M automation system, wire/wireless remote control, data logger application, redundant solution.

Generation	CPU	Ethernet	Memory Expansion	Power consumption
I-7188 Series	40 MHz	10 BaseT	SRAM, Flash	2 W
$\mu$ PAC-7186	80 MHz	10/100 BaseTX	SRAM, Flash	1.5 W

## Top 10 reasons to choose $\mu$ PAC by ICP DAS:

### 1 Powerful Embedded OS — MiniOS7

MiniOS7 is the most stable OS used in the last decade. Up to now, several hundred thousand copies with our PACs have been distributed worldwide.

#### Features:

- DOS-like embedded OS
- Antivirus ability
- Internet connectivity
- Libraries & demo programs for various peripherals, devices and remote I/O modules
- Short boot time period (<1 Second)
- Less memory resource required
- Faster watchdog response time

### 2 Rich Development Support

We provide over 100 Libraries and Demos for users to develop applications easily and quickly to integrate with some popular software, SCADA, protocols or tools.

- Provide Libraries: Xserver, Modbus, MiniOS7 Framework
- Support development tool: ISaGRAF, C Language



### 3 Patented Technology: "Self-Tuner" Chip

Our  $\mu$ PAC contains a patented "Self-tuner" chip which automatically tunes Baud rate and data format in the whole RS-485 network. It also handles the direction of RS-485 communication line.

### 4 Unique 64-bit Hardware Serial Number Protecting Your Program

All  $\mu$ PAC-7186 series and most I-7188 series come with a 64-bit unique hardware serial number. A unique serial number is assigned to each hardware device to protect your software against piracy.

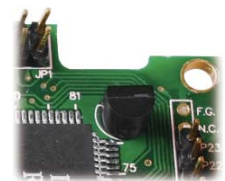

### 5 Built-in RTC — Real Time Clock

- Provides second, minute, hour, day of week, day of month, month & year (1980 ~ 2079)
- With on-board battery
- Data valid up to 10 years
- Keep accurate time/date while the main power is lost





### 6 5-Digit 7-Segment LED Display

Optional 5-digit 7-segment LED display shows information, such as system status, user-defined message.

- Display numbers, letters, symbols, units, etc.

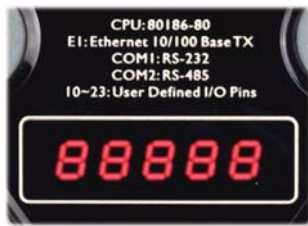

### 8 Built-in WDT — Watchdog Timer

When I-7188 or  $\mu$ PAC-7186 is power-up, the watchdog timer can be enabled. The watchdog timer resets the controller after a short period (about 0.8 seconds) when the running software fails to reset the watchdog.

### 7 Highly Reliable Under Harsh Environment

Our PAC can operate in a wide range of temperature and humidity.

- Operating Temperature: -25 ~ +75°C
- Storage Temperature: -40 ~ +80°C
- Humidity: 10 ~ 90% RH, non-condensing



### 9 Various Memory Expansion Options

#### • Memory Configuration:

Memory	Size	Description
Flash Disk	64 MB NAND	rugged data storage that resists shock and vibration. MiniOS7 file system and APIs are provided to read/write files.
NVRAM	31 bytes	No writing limitation
EEPROM	2 KB or 16 KB	to store not frequently changed parameters.

Note: Different model has different SRAM size, NVRAM and Flash size. Please refer to the Selection Guide.

#### • Expansion Memory Board (Optional):



Flash memory Board



Battery-backup RAM Board

The writing protection and limitation of Flash and EEPROM prevent memories from being modified due to noise interference. NVRAM doesn't have writing limitation. It is the best choice for temporary data storage. Furthermore, it is non-volatile, data can be kept even when the power is lost or the system crashes.

### 10 Expandable Local I/Os & Hardware Functions

Most  $\mu$ PAC-7186 and I-7188 series have a built-in expansion bus. X-Board can be plugged on the Bus to expand I/O channels, COM Ports, memories or hardware functions (Listed below).

- DI, DO, AI, O, Timer/Counter, Communications, Flash memory, Battery backup SRAM, Motion control, Self-test We provide various standard X-Boards, and also ODM service. The X-Board has two methods to combine with the palm-size PAC. Plug an X-Board into a palm-size PAC or mount a controller on a larger X-Board.

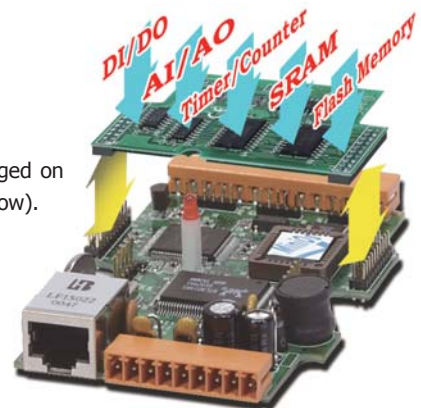

Plug an X-Board into a palm-size PAC

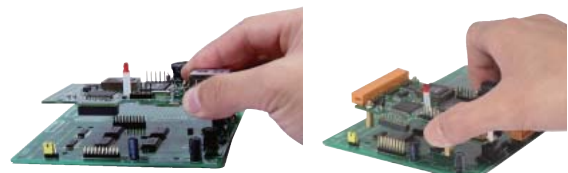
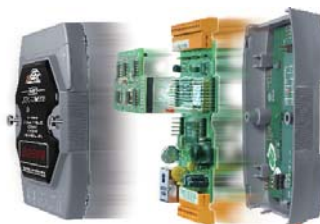

Mount a controller on a larger X-Board

**Selection Guide:**

# I-7188

**Ethernet Port**

- : Without I/O Expansion Bus & Ethernet Port
- E: With Ethernet Port
- X: Without Ethernet Port



**Software & Communication Ports**

- A: C language based (2-DI , 2-DO, RS-232 and RS-485)
- B: C language based (1-DI , 1-DO, RS-232 and RS-485)
- C: C language based (2-DI , 3-DO, RS-232 and RS-485)
- X: C language based (RS-232 and RS-485)
- G: ISaGRAF

**LED Display**

- D: With 5-digit 7-segment LED Display

# μPAC-7186



**Software**

- X: C language based
- G: ISaGRAF

**LED Display**

- D: With 5-digit 7-segment LED Display

**Special Feature**

- SM: 640 KB SRAM
- FD: 64 MB NAND Flash

C Language Based I-7188 and μPAC-7186



Serial Connectivity									
Model Name	CPU	SRAM	Flash	I/O Expansion Bus	64-bit Hardware Serial Number	RTC	DI	DO	RS-232/RS-485
<b>I-7188</b> <b>I-7188D</b>	40 MHz	256 KB	512 KB	-	-	Yes	-	-	4
<b>I-7188XA</b> <b>I-7188XAD</b>		512 KB		For memory board only	Yes		2	2	(Note)
<b>I-7188XB</b> <b>I-7188XBD</b>		512 KB		Yes	-		1	1	1/1
<b>I-7188XC</b> <b>I-7188XCD</b>	20 MHz	128 KB	Yes	-	-	2	3		

Note: RS-232 × 2, RS-485 × 1, RS-232/485 × 1

Model Name	CPU	SRAM	Flash	NAND Flash	I/O Expansion Bus	RTC	DI	DO	Ethernet	RS-232/RS-485
<b>I-7188EA</b> <b>I-7188EAD</b>	40 MHz	512 KB	512 KB	-	-	Yes	6	7	10 Base-T	1/1
<b>I-7188EX</b> <b>I-7188EXD</b>					Yes		-	-		
<b>μPAC-7186EX</b> <b>μPAC-7186EXD</b>	80 MHz	512 KB	512 KB	-	Yes	Yes	-	-	10/100 Base-Tx	1/1
<b>μPAC-7186EX-SM</b> <b>μPAC-7186EXD-SM</b>		640 KB								
<b>μPAC-7186EX-FD</b> <b>μPAC-7186EXD-FD</b>		512 KB								

ISaGRAF Based μPAC-7186 & I-7188



Model Name	CPU	SRAM	Flash	I/O Expansion Bus	RTC	DI	DO	Ethernet	RS-232/RS-485
<b>μPAC-7186EG</b> <b>μPAC-7186EGD</b>	80 MHz	768 KB	512 KB	Yes	Yes	-	-	10/100 Base-TX	1/1
<b>I-7188XG</b> <b>I-7188XGD</b>	40 MHz	512 KB				1	1	-	1/1

# 2.1 I/O Expansion Boards for 7188/7186 Series

## Introduction:

X-Board is a small I/O expansion board inserted in μPAC (μPAC-7186 Series & I-7188 series) for expanding I/O functions. Most μPACs (except some modules like I-7188 & I-7188D) support one I/O expansion bus. Each bus can be plugged

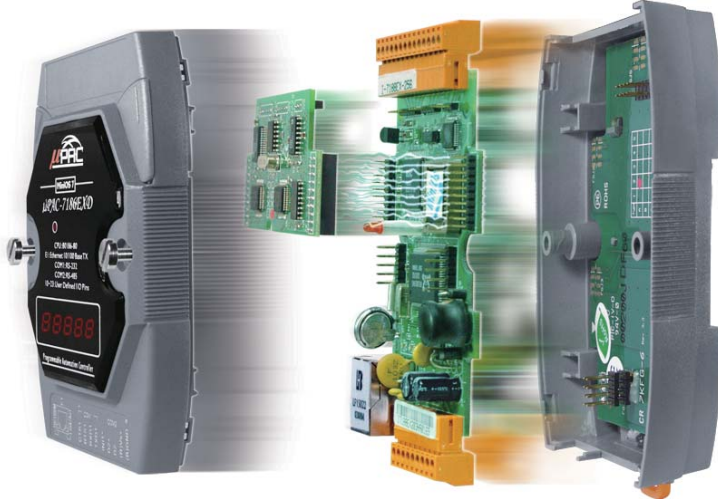

in one X-Board. The X-Board allows users to implement various I/O functions such as DI, DO, A/D, D/A, Timer/Counter, UART, flash memory, battery backup SRAM, AsicKey & other I/O functions.

Users may choose our functioned X-Boards (model number X1xx ~ X7xx) or design their own I/O expansion boards (module number X0xx). We have designed several X-Boards for expanding the μPAC's features. If users choose a small size X-Board, then they can mount this I/O expansion board directly onto the μPAC. Customized I/O Expansion Boards can be ordered through ODM project.

## Selection Guide:

Following μPAC supports I/O Expansion Bus, can mount one X-Board

- For C language solution: I-7188XB(D), I-7188EX(D), μPAC-7186EX(D), μPAC-7186PEX(D), μPAC-7186EX(D)-FD, μPAC-7186EX(D)-SM
- For ISaGRAF solution: I-7188XG(D), μPAC-7186EG(D)

X-Board is Series has following common specifications

- DI channel: Dry contact, sink type, non-isolated
- DO channel: Open Collector, sink type, 100 mA/channel load current, non-isolated

### ✓ DI, DO Expansion



Model Name	DI (Dry Contact)	DO (Open Collector)
X107	6	7
X110	14	-
X111	-	13

### ✓ AI, AO, DI, DO Expansion



Model Name	AI (12-bit)		AO (12-bit)		DI (Dry Contact)	DO (Open Collector)
	Channel	Range	Channel	Range		
X202	7	0 ~ 20 mA	-	-	-	-
X203	2	0 ~ 20 mA	-	-	2	6
X303	1	±5 VDC	1	±5 VDC	4	6
X304	3	±5 VDC	1	±5 VDC	4	4
X305	7	±5 VDC	1	±5 VDC	2	2
X308	4	0 ~ 10 VDC	-	-	-	6
X310	2	0 ~ 20 mA 0 ~ 10 VDC	2	0 ~ 10 VDC	3	3
X324	-	-	4	0 ~ 5 VDC	-	4



RS-232/422/485, DI, DO Expansion

Model Name	Serial Port			DI (Dry Contact)	DO (Open Collector)	EEPROM	
	Type	Channel	Wire				
X503	RS-232	1	5 Wire	-	-	-	
X504	RS-232	2	5 Wire and 9 Wire				
X505	RS-232	3	5 Wire				
X506	RS-232	6	3 Wire				
X507	RS-422/485	1	4/2 Wire	4	4	256 KB	
X508	RS-232	1	5 Wire	4	4		
X509	RS-232	2	3 Wire	4	4		
X510	RS-232	1	3 Wire	5	5		
X510-128	RS-232	1	3 Wire	5	5		128 KB
X511	RS-485	3	2 Wire	-	-		-
X511i	RS-485	3	2 Wire (Isolation)	-	-		
X518	RS-232	1	5 Wire	-	8		
X520	RS-232	4	3 Wire	1	2		

Memory Expansion

Model Name	Memory Type	Size	Data Retention	Endurance
X602	NAND Flash	64 MB	10 years	100,000 erase cycles
X603		256 MB		
X607	Battery Backup SRAM	128 KB	9 years	No erase cycle limitation
X608		512 KB		

Encoder Expansion

Model Name	Axis	Counter	Mode	Max. Speed	5V Input Level	12V Input Level (with 1 K $\Omega$ external resistors)	24V Input Level (with 2 K $\Omega$ external resistors)
X702	2	32-bit	Quadrant, CW/CCW, Pulse/Direction	1 MHz	3.5 ~ 5 V 0 ~ 2 V	5 ~ 12 V 0 ~ 2 V	7 ~ 24 V 0 ~ 2 V
X703	3						

Note: ISaGRAF doesn't support X702 and X703.



7188XC only						
Model Name	DI (Dry Contact)	DO (Open Collector)	AI (12-bit)		AO (12-bit)	
			Channel	Range	Channel	Range
X101	-	8	-	-	-	-
X106	DI $\times$ 3 or DO $\times$ 2		-	-	-	-
X200	-	-	1	0 ~ 2.5 VDC	-	-
X302	-	-	1	$\pm$ 5 VDC	1	$\pm$ 5 VDC

# 3. 5000 Series $\mu$ PAC

## 3.1 $\mu$ PAC-5000 Series

### $\mu$ PAC-5000 Family

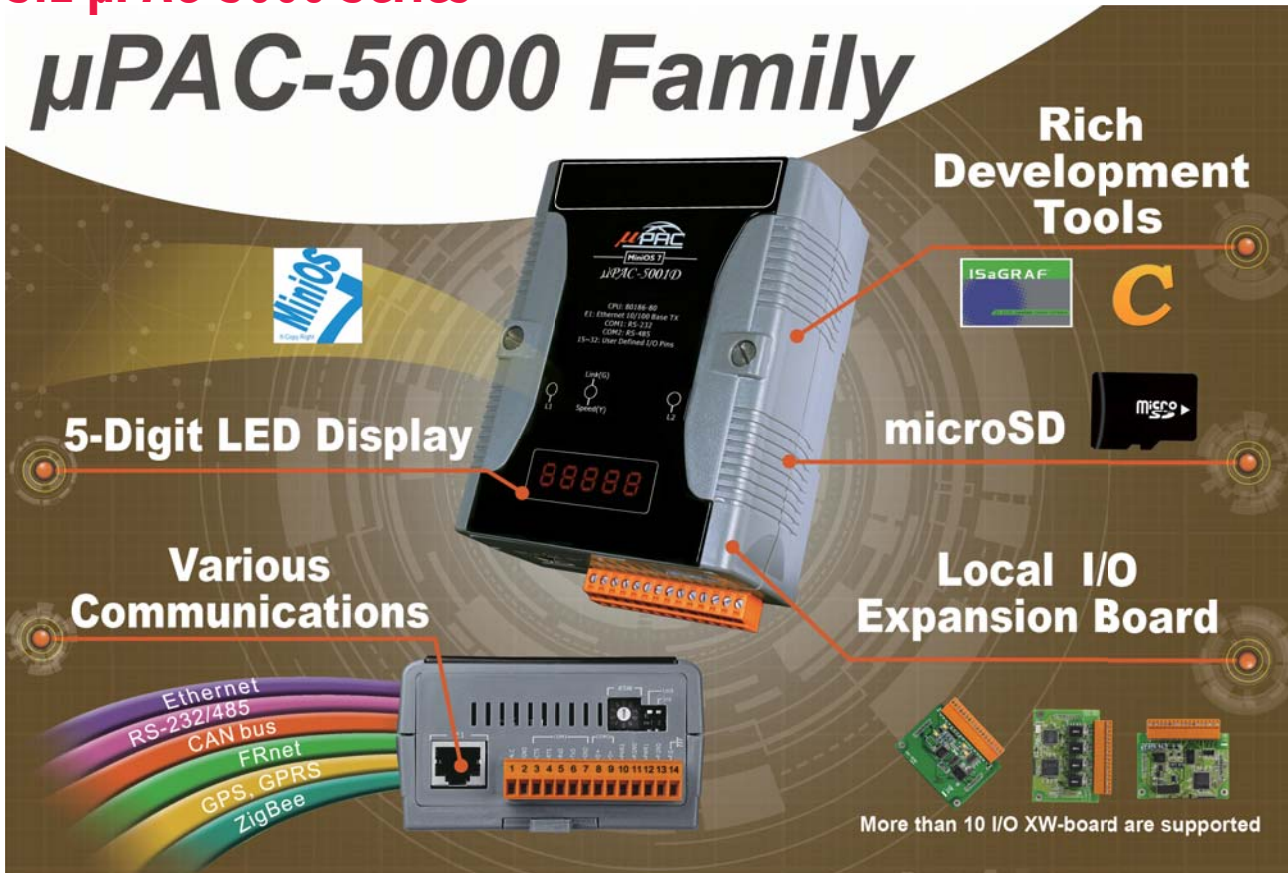

The  $\mu$ PAC-5000 Series is equipped a 80186 CPU running a MiniOS7 operating system, a variety of connectivity options (Ethernet, RS-232/485) and an I/O expansion bus.

The  $\mu$ PAC-5000 series is an enhanced version of  $\mu$ PAC-7186. Owing to the bigger and special form factor design, the  $\mu$ PAC-5000 can add an internal wireless module, such as 2G, 3G, Wi-Fi, GPS for different wireless application. The optional I/O expansion board, XW-board, is two times larger than the X-board of  $\mu$ PAC-7186 and provides high-protection I/O. With built-in micro SD, the  $\mu$ PAC-5000 can be used as a data logger.

### Features:

#### 1 MiniOS7 Inside



**MiniOS7**  
**80186 CPU**  
 **$\mu$ PAC-5000 Series**

- DOS-like real-time OS
- Boot up in 0.4 ~ 0.8 second
- Built-in hardware diagnostic
- Standard version for C language programming
- ISaGRAF version for IEC 61131-3 programming

#### 2 Local I/O and Communication Expansion Board

The  $\mu$ PAC 5000 series is equipped with an I/O expansion bus to support one optional expansion board, called XW-Board. It can be used to implement various I/O functions such as DI, DO, A/D, D/A, Timer/Counter and various communication interface options, such as RS-232/422/485, CAN.



#### 3 Remote I/O Module and Expansion Unit

With the built-in RS-485 and Ethernet ports, the 5000 series can connect RS-485/Ethernet remote I/O units (RU-87Pn/ET-87Pn) or modules (I-7000/M-7000/ET-7000). With an XW-Board, the 5000 series can have more communication ports or different interface to connect to other type of devices, for example, CANOpen devices, or DeviceNet devices.

#### 4 Multiple Communication Interfaces

Several different types of communication interface are available that enable I/O modules to be expanded and connected to external devices:

1. Ethernet      2. RS-232/485      3. CAN bus      4. GPS      5. 2G/3G      6. Wi-Fi

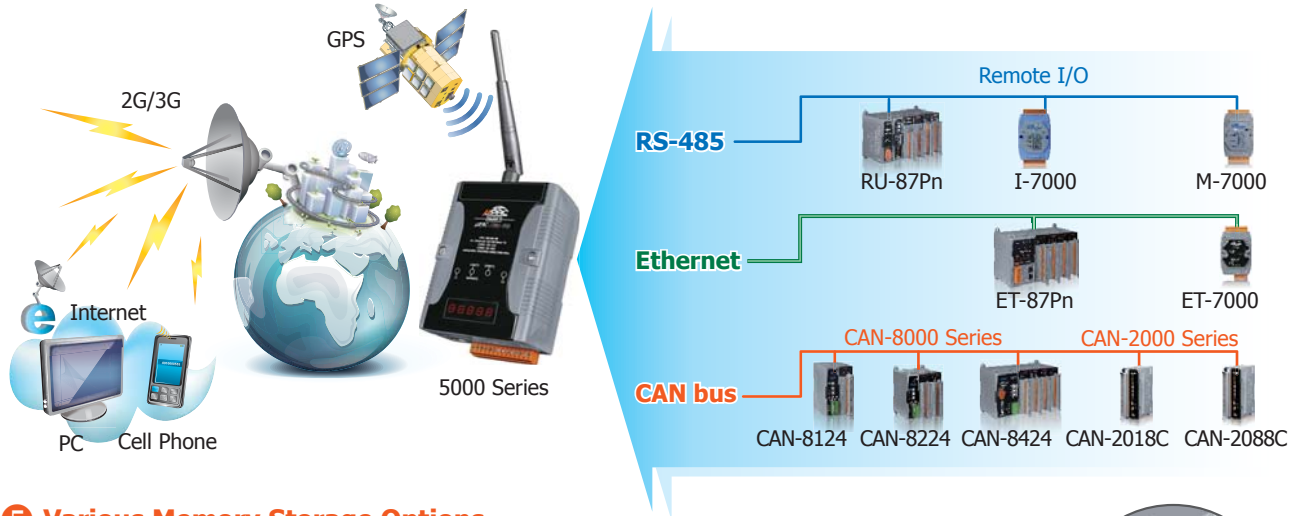

#### 5 Various Memory Storage Options

μPAC-5000 provides various memory storage options. Customers can choose the memory based on their characteristics.

- 16 KB EEPROM: to store not frequently changed parameters.
- microSD: to implement portable data logging applications.
- 256 MB NAND Flash Disk: rugged data storage to resist shock and vibration.

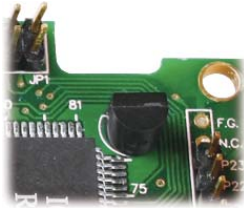
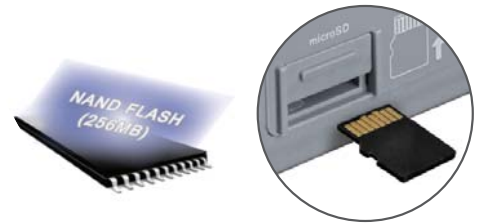

#### 6 Unique 64-bit Hardware Serial Number to Protect Your Program

A unique 64-bit serial number is assigned to each hardware device to protect your software against piracy.



#### 7 Plastic and Metal Casing

The default case is plastic material. Metal casing is also offered to OEM version.

#### 8 Highly Reliable Under Harsh Environment

Our μPACs operate in a wide range of temperature and humidity.

- Operating Temperature: -25 ~ +75°C
- Storage Temperature: -30 ~ +80°C
- Humidity 10 ~ 90% RH (non-condensing)



### μPAC-5000 + XW-Board:

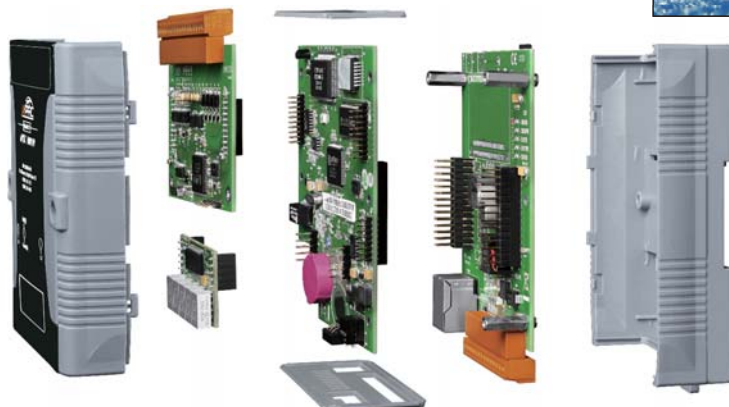

#### 9 Redundant Power Inputs

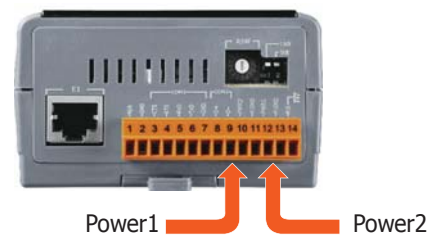



## Selection Guide:

# μPAC-5



### Wireless Communication

- 0: None
- 2: 2G (GPRS) or 3G (WCDMA)
- 9: ZigBee

### Software

- 1: C language based
- 7: ISaGRAF

### Display or Casing

- D: LED Display
- M: Metal Casing

### Memory

- FD: 256 MB Flash

## ✓ C Language Based μPAC-5000

Model Name	CPU	Flash	SRAM	Memory Expansion	Ethernet	Wireless Communication	RS-232/RS-485
μPAC-5001(D)	80 MHz	512 KB	512 KB	microSD	10/100 BaseTX	-	1/1
μPAC-5001(D)-FD				microSD + 256 MB Flash			

## ✓ C Language Based μPAC-5000 with 2G (GPRS)/3G (WCDMA)

Model Name	CPU	Flash	SRAM	Memory Expansion	Ethernet	Wireless Communication	RS-232/RS-485
μPAC-5201(D)	80 MHz	512 KB	512 KB	microSD	10/100 BaseTX	<b>2G (GPRS)</b>	1/1
uPAC-5201(D)-3GWA	80 MHz	512 KB	512 KB	microSD	10/100 BaseTX	<b>3G (WCDMA)</b>	1/1

The wireless 2G (GSM, GPRS) and 3G (WCDMA) are the public wireless telephone technologies. The wide range of remote control applications are enabled by 2G/3G services such as audio, SMS, GPRS and WCDMA. Additionally, these applications can manage a small, medium and large number of unmanned remote devices as well as mobile terminals using the 2G/3G telecom network. They are widely applied in various applications like hydrographic monitoring, intelligent power, flow meter report system and GPS car-tracking system anytime anywhere.

### 2G (GPRS) Specifications

Band	850/900/1800/1900 MHz
GPRS Multi-slot	Class 10/8
GPRS Mobile Station	Class B
GPRS Class 10	Max. 85.6 kbps
CSD	Up to 14.4 kbps
Compliant to GSM phase 2/2+	Class 4 (2 W @ 850/900 MHz); Class 1 (1W @ 1800/1900 MHz)
Coding Schemes	CS 1, CS 2, CS 3, CS 4
SMS	Text and PDU mode

### 3G (WCDMA) Specifications

Band	UMTS : 2100/1900/850 MHz
Data Transfer	UMTS / HSDPA / HSUPA Upload: Max. 5.76 Mbps; Download: Max. 7.2 Mbps

### Optional Antenna for 2G and 3G

	<b>ANT-421-01</b>	
	Connector	SMA Male
	Radiation	Omni-Directional
	Band	824 ~ 960 MHz, 1710 ~ 2170 MHz
	Gain (dBi)	1.0 ±0.7 @ 830 MHz 0.5 ±0.7 @ 1730 MHz
	Cable Length	3 m
	Installation	Magnetic mount base

### Standard Antenna for 2G and 3G

	<b>ANT-421-02</b>	
	Connector	SMA Male
	Radiation	Omni-Directional
	Band	824 ~ 960 MHz 1710 ~ 2170 MHz
	Gain (dBi)	-0.9 ±0.7 @ 890 MHz +1.7 ±0.7 @ 1930 MHz
	Cable Length	14 cm

## ✓ ISaGRAF Based μPAC-5000



Model Name	CPU	Flash	SRAM	Memory Expansion	Ethernet	Wireless Communication	RS-232/RS-485
μPAC-5007(D)	80 MHz	512 KB	768 KB	microSD + 512 KB Battery	10/100 BaseTX	-	1/1
μPAC-5207(D)				Backup SRAM		<b>2G (GPRS)</b>	

# 3.2 WinPAC-5000 Series

## Introduction:

The WP-5000 series is equipped an ARM CPU and running a Windows CE.NET 5.0/7.0 operating system. Compared to μPAC-5000, WP-5141 series has a VGA port to support graphic display and no need HMI. WP-5231 series has an optional internal wireless module, such as GPS, 2G/3G, Wi-Fi. Using Windows CE.NET 5.0/7.0, it is capable of running PC-based software, such as Visual Basic.NET, Visual C#, Embedded Visual C++, SCADA software, ISaGRAF.

## Features:

1



- Supports PC based software: eVC and VS .NET 2005/2008
- Web server, FTP server, Telnet server
- ISaGRAF version for IEC 61131-3 programming
- InduSoft version for SCADA solution

The WinPAC-5000 series features hard real-time capability, small core size, fast boot speed, interrupt handling at a deeper level, achievable deterministic control and low cost. Using Windows CE.NET 5.0/7.0 gives it the ability to run PC-based control software such as Visual Basic.NET, Visual C#, Embedded Visual C++, SCADA software, SoftPLC.

## 2 Local I/O and Communication Expansion Board

The optional I/O expansion board, XV-Board and XW-Board, provides high-protection I/O, such as DI, DO, A/D, D/A and various communication ports.

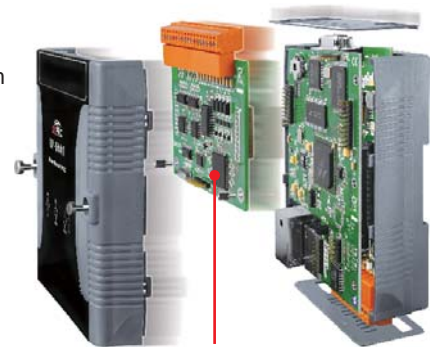

XV-Board or XW-Board

## 3 Remote I/O Module and Expansion Unit

With the built-in RS-485 and Ethernet ports, the 5000 series can connect RS-485/Ethernet remote I/O units (RU-87Pn/ET-87Pn) or modules (I-7000/M-7000/ET-7000). With an XW-Board, the 5000 series can have more communication ports or different interface to connect to other type of devices, for example, CANopen devices, or DeviceNet devices.

## 4 Multiple Communication Interfaces

Several different types of communication interface are available that enable I/O modules to be expanded and connected to external devices:

1. Ethernet
2. RS-232/485
3. CAN bus
4. GPS
5. 3G

The internal wireless module options are available for WP-5231 series.

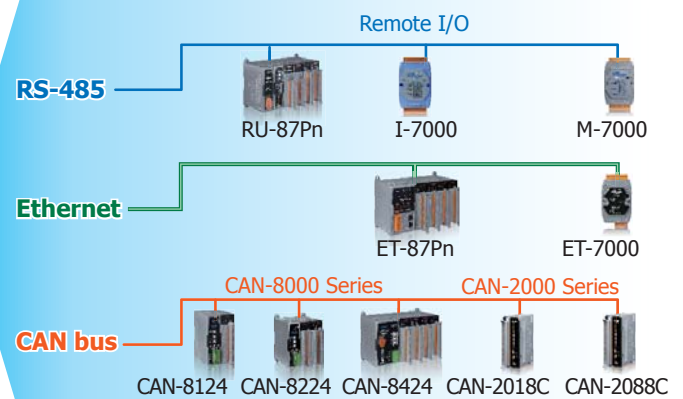
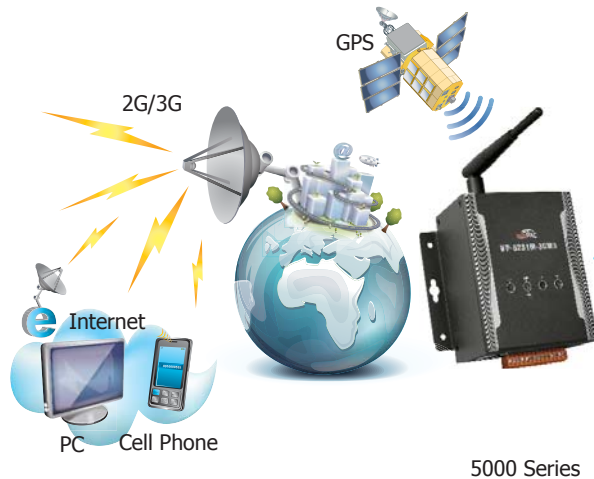

## 5 Various Memory Storage Options

WinPAC-5000 provides various memory storage options, such as EEPROM and microSD.

- 16 KB EEPROM: to store not frequently changed parameters.
- microSD/microSDHC: to save application program, image file, audio file and data.

## 6 Unique 64-bit Hardware Serial Number to Protect Your Program

A unique 64-bit serial number is assigned to each hardware device to protect your software against piracy.

## 7 Plastic and Metal Casing

The default case is plastic material. Metal casing is also offered to provide extra security.

## 8 Highly Reliable Under Harsh Environment

Our WinPAC operate in a wide range of temperature and humidity.

- Operating Temperature: -25 ~ +75°C
- Storage Temperature: -30 ~ +80°C
- Humidity 10 ~ 90% RH (non-condensing)

**Selection Guide:**

**WP-5** **X** **X** **X** **(M)** - **YY** - **OS**

**X**

**CPU**

- 1: PXA270
- 2: Cortex-A8, 1 GHz

**X**

**Software**

- 1: Standard
- 7: ISaGRAF
- 8: Win-GRAF
- 9: InduSoft

**(M)**

**Case**

- Metal

**YY**

**Options**

- OD: Audio
- 3GWA: 3G, WCDMA

**Standard WinPAC**



Model Name	OS	CPU	Flash	SDRAM	VGA Resolution	Ethernet	RS-232/RS-485	I/O Expansion Bus	Audio Port	Case
WP-5231-CE7	WinCE 7.0	Cortex-A8, 1 GHz	256 MB	512 MB	1024 × 768	1	2/2	XV-Board	-	Plastic
WP-5231M-CE7	WinCE 7.0	Cortex-A8, 1 GHz	256 MB	512 MB	1024 × 768	1	2/2	XV-Board	-	Matel
WP-5141	WinCE 5.0	PXA270, 520 MHz	64 MB	128 MB	800 × 600	2	2/1	XW-Board	-	Plastic
WP-5141-OD									Yes	Plastic

**ISaGRAF Based WinPAC**



Model Name	OS	CPU	Flash	SDRAM	VGA Resolution	Ethernet	RS-232/RS-485	I/O Expansion Bus	Audio Port	Case
WP-5147	WinCE 5.0	PXA270, 520 MHz	64 MB	128 MB	800 × 600	2	2/1	XW-Board	-	Plastic
WP-5147-OD									Yes	Plastic

**Win-GRAF Based WinPAC**



Model Name	OS	CPU	Flash	SDRAM	VGA Resolution	Ethernet	RS-232/RS-485	I/O Expansion Bus	Audio Port	Case
WP-5238-CE7	WinCE 7.0	Cortex-A8, 1 GHz	256 MB	512 MB	1024 × 768	1	2/2	XV-Board	-	Plastic
WP-5238M-CE7	WinCE 7.0	Cortex-A8, 1 GHz	256 MB	512 MB	1024 × 768	1	2/2	XV-Board	-	Matel

**InduSoft Based WinPAC**



Model Name	OS	CPU	Flash	SDRAM	VGA Resolution	Ethernet	RS-232/RS-485	I/O Expansion Bus	Audio Port	Case
WP-5239-CE7	WinCE 7.0	Cortex-A8, 1 GHz	256 MB	512 MB	1024 × 768	1	2/2	XV-Board	-	Plastic
WP-5239M-CE7	WinCE 7.0	Cortex-A8, 1 GHz	256 MB	512 MB	1024 × 768	1	2/2	XV-Board	-	Matel

**Appearance:**

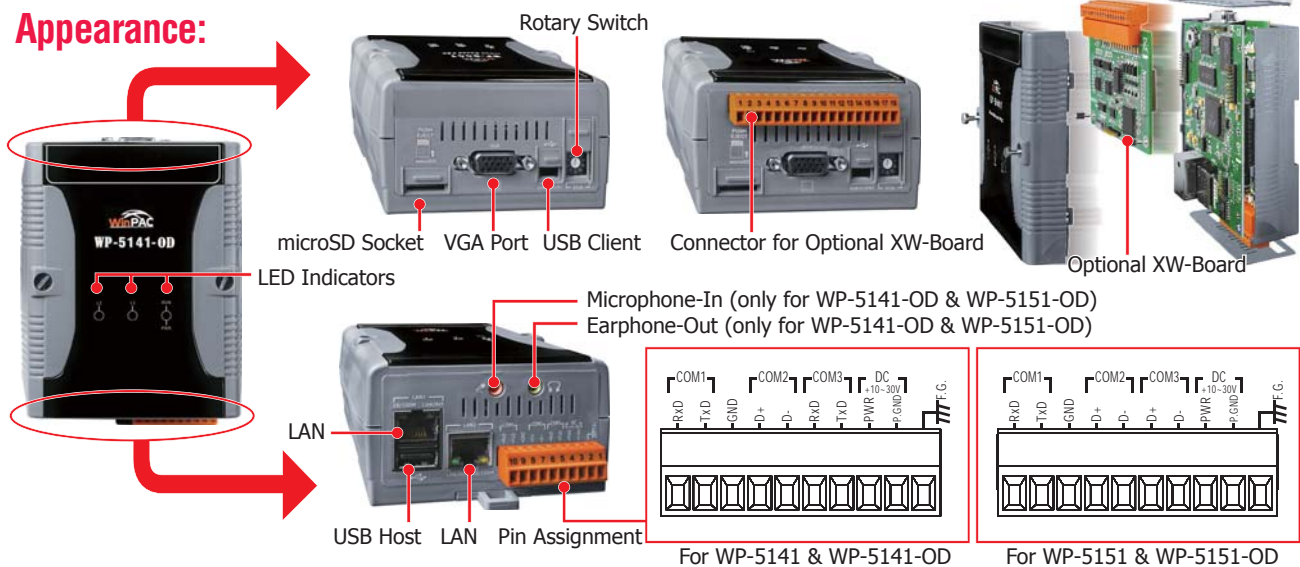



Standard WinPAC with 3G/4G (WCDMA)



Model Name	OS	CPU	Flash	SDRAM	VGA Resolution	Ethernet	RS-232/RS-485	I/O Expansion Bus	Wireless	GPS
WP-5231PM-4GE-CE7	WinCE 7.0	Cortex-A8, 1 GHz	256 MB	512 MB	1024 × 768	1	1/2	XV-Board	4G LTE	Yes
WP-5231PM-4GC-CE7									4G LTE	
WP-5231PM-3GWA-CE7									3G, WCDMA	

Win-GRAF Based WinPAC WinPAC with 3G (WCDMA)



Model Name	OS	CPU	Flash	SDRAM	VGA Resolution	Ethernet	RS-232/RS-485	I/O Expansion Bus	Wireless	GPS
WP-5238PM-3GWA-CE7	WinCE 7.0	Cortex-A8, 1 GHz	256 MB	512 MB	1024 × 768	1	2/2	XV-Board	3G, WCDMA	Yes

InduSoft Based WinPAC WinPAC with 3G (WCDMA)



Model Name	OS	CPU	Flash	SDRAM	VGA Resolution	Ethernet	RS-232/RS-485	I/O Expansion Bus	Wireless	GPS
WP-5239PM-3GWA-CE7	WinCE 7.0	Cortex-A8, 1 GHz	256 MB	512 MB	1024 × 768	1	2/2	XV-Board	3G, WCDMA	Yes

Models	WP-5231PM-4GE	WP-5231PM-4GC
<b>GSM System</b>		
Frequency Band	GSM : 850/900/1800/1900 MHz	
GPRS connectivity	GPRS class 12/10; GPRS station class B	
DATA GPRS	Downlink transfer: Max. 85.6 kbps; Uplink transfer: Max 42.8 kbps	
<b>3G System</b>		
Frequency Band (MHz)	WCDMA 850/900/2100	WCDMA 900/2100 TD-SCDMA 1900/2100 CDMA2000 (BC0) 800
Data Transmission	DC-HSPA+ Download: Max. 42 Mbps; Upload: Max 5.76 Mbps TD-SCDMA Download: Max. 4.2 Mbps; Upload: Max 2.2 Mbps CDMA2000 EVDO Download: Max. 14.7 Mbps; Upload: Max 5.4 Mbps	
<b>4G System</b>		
Frequency Band (MHz)	FDD LTE: B1/B3/B5/B7/B8/B20	FDD LTE: B1/B3/B8 TDD LTE: B38/B39/B40/B41
Data Transmission	Download Max 100 Mbps / Upload Max 50 Mbps	

**Appearance:**

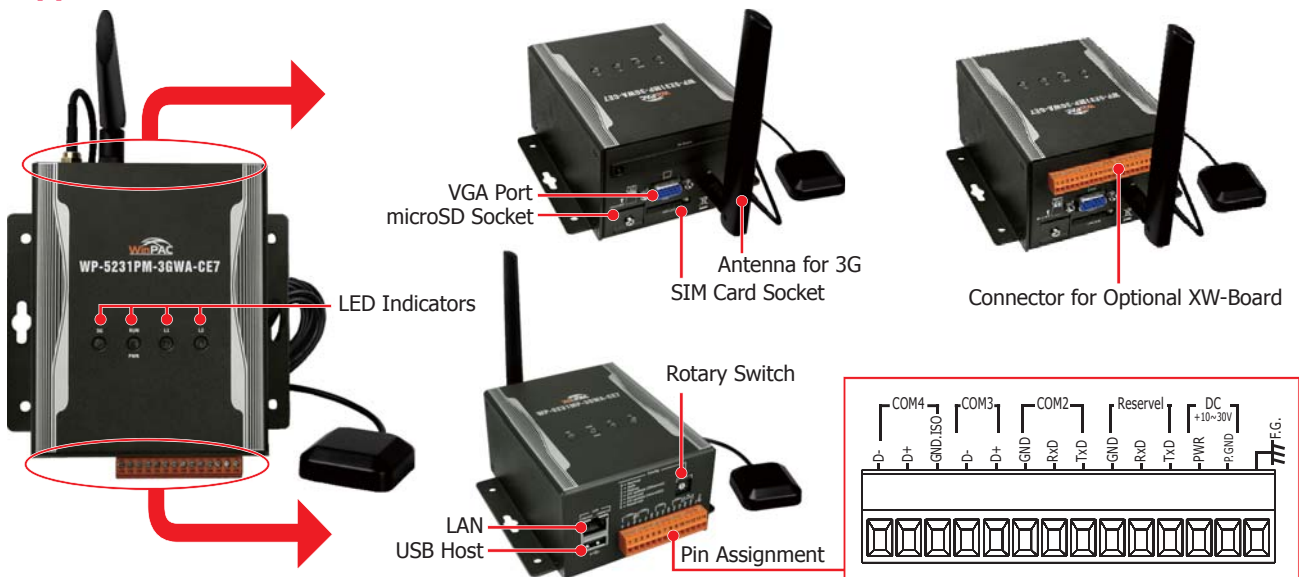

# 3.3 LinPAC-5000 Series

The LinPAC-5000 family is a palm-size PAC and is designed to provide fast, convenient, flexible and simplified solutions for industrial and embedded applications. It is equipped with an ARM CPU running a Linux kernel operating system, multiple communication interfaces (VGA, USB, Ethernet, RS-232/485 and audio ports) and powerful software including development tools.

## Features:

### 1 Wide range of Development Support Tools



**Linux kernel**  
**ARM CPU**  
**LP-5000 Series**

- LinPAC SDK for Windows and Linux
- Support for GNU C Language
- Support for GUI: Using GTK + Library
- Support for DCON, Modbus and SNMP Protocols
- Support for USB to Serial Converter



### 2 Local I/O and Communication Expansion Board

The LinPAC-5000 series is equipped with an I/O expansion bus to support one optional expansion board, called the XV-Board or XW-Board. It can be used to implement various I/O functions, such as DI, DO, A/D, D/A, Timer/Counter and various communication interfaces, such as RS-232/422/485.

### 3 Remote I/O Module

With the built-in RS-485 and Ethernet ports, the LinPAC-5000 series can connect to remote RS-485/Ethernet I/O units (RU-87Pn/ET-87Pn) or modules (I-7000/M-7000/ET-7000).

### 4 Multiple Communication Interfaces

Several different types of communication interface are available that enable I/O modules to be expanded and connected to external devices:

1. Ethernet
2. RS-232/485
3. USB host
4. GPS
5. GSM/GPRS



### 5 Various Memory Storage Options

LinPAC-5000 provides various memory storage options, such as EEPROM, Flash or microSD. Customers can choose the memory based on their characteristics.

- 16 KB EEPROM: to store not frequently changed parameters.
- microSD/microSDHC: to implement portable data logging applications.

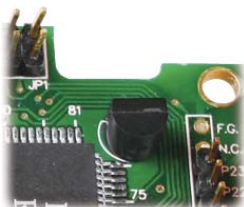

### 6 Unique 64-bit Hardware Serial Number to Protect Your Program

A unique 64-bit serial number is assigned to each hardware device to protect your software against piracy.

### 8 Highly Reliable Under Harsh Environments

The LinPAC-5000 operates in a wide range of temperatures and humidity levels.

- Operating Temperature: -25 ~ +75°C
- Storage Temperature: -30 ~ +80°C
- Humidity 10 ~ 90% RH (non-condensing)

### 7 Plastic and Metal Casing

The default case is plastic material. Metal casing is also offered to provide extra security.

**Standard LinPAC**



Model Name	OS	CPU	Flash	SDRAM	VGA Resolution	Ethernet	RS-232/RS-485	I/O Expansion	Wireless	GPS	Audio Port	Case
LP-5231	Linux kernel 3.2	Cortex-A8, 1 GHz	512 MB	512 MB	1280 × 1024	1	2/2	XV-Board	-	-	-	Plastic
LP-5231M									-	-	-	Matel
LP-5231PM-3GWA									3G, WCDMA	Yes	-	Plastic
LP-5231PM-4GE									4G LTE	Yes	-	Matel
LP-5231PM-4GC									-	-	-	-
LP-5131	Linux kernel 2.6	PXA270, 520 MHz	64 MB	128 MB	800 × 600	1	2/1	XW-Board	-	-	-	Plastic
LP-5131-OD											Yes	Plastic
LP-5141											-	Plastic
LP-5141-OD											Yes	Plastic

The controller supports following software development tools:

1. SDK for Linux environment
2. SDK for Windows environment

# 3.4 I/O Expansion Boards

One PAC can only plug only one XV-Board or XW-Board.

	XV-Board	XW-Board
PAC Supported	WP-52xx, LP-52xx, VPD-1xx	uPAC-5000, WP-51xx, LP-51xx
Bus Type	Serial	Parallel
Bus Speed	Slow	Fast
DIO Board	Yes	Yes
Multifunction Board (AI+AO+DIO)	Yes	Yes
RS-232/485 Board	-	Yes

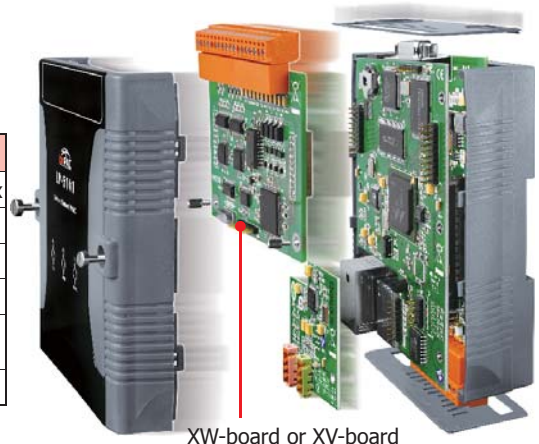

DIO Board



Model Name	Series	DI			DO		
		Channels	Sink/Source	Contact	Channels	Type	Sink/Source
<b>XV107</b>	XV	8	Source	Wet	8	Open Collector	Sink/Source
<b>XV107A</b>		8	Sink		8	Open Emitter	Source
<b>XV110</b>		16	Sink/Source	Wet + Dry	-	-	-
<b>XV111</b>		0	-	-	16	Open Collector	Sink
<b>XV111A</b>		0	-	-	16	Open Emitter	Source
<b>XV116</b>		5	Sink/Source	Wet	6	Power Relay, Form A	-
<b>XW107</b>	XW	8	Source	Dry	8	Open Collector	Sink
<b>XW107i</b>		8	Sink/Source	Wet	8	Open Collector	Sink
<b>XW110i</b>		16	Sink/Source	Wet + Dry	-	-	-
<b>XW111i</b>		-	-	-	16	Open Collector	Sink

Multifunctional Board



Model Name	Series	AI		AO		DI		DO	
		Channels	Type	Channels	Type	Channels	Type	Channels	Type
<b>XV304</b>	XV	8	Thermistor (*)	-	-	8	Dry, Wet(Sink)	8	Open Collector, Sink
<b>XV306</b>		4	Voltage/Current	-	-	4	Wet	4	Relay, FormA, 6A
<b>XV307</b>		-	-	2	Voltage/Current	4	Wet	4	Relay, FormA, 6A
<b>XV308</b>		8	Voltage/Current	-	-	DI+DO=8	Dry, Source	DI+DO=8	Open Collector, Sink
<b>XV310</b>		4	Voltage/Current	2	Voltage/Current	4	Dry, Source	4	Open Collector, Sink
<b>XW304</b>	XW	6	±5 V, 0 ~ 5 V	1	±5 V	4	Dry, Source	4	Open Collector, Sink
<b>XW310</b>		4	±10 V	2	±10 V	3	Dry, Source	3	Open Collector, Sink
<b>XW310C</b>		4/8	0 ~ 20 mA	2	0 ~ 20 mA	3	Dry, Source	3	Open Collector, Sink

(\*): XV304 supports Precon ST-A3, Fenwell U, YSI L100, YSI L300, YSI L1000, YSI B2252, YSI B3000, YSI B5000, SI B6000, YSI B10000, YSI H10000, YSIH30000 and User-defined

Serial Port Board



Model Name	Series	Serial port			DI		DO	
		Type	Channels	Wire	Channels	Type	Channels	Type
<b>XW506</b>	XW	RS-232	6	TxD, RxD, GND	-	-	-	-
<b>XW509</b>			2	TxD, RxD, GND and TxD, RxD, CTS, RTX, GND	4	Wet, Sink/Source	4	Open Collector, Sink
<b>XW507</b>		RS-422/485	1	TxD+/D+ TxD-/D-, RxD+, RxD-, GND	5	Wet, Sink/Source	5	Open Collector, Sink
<b>XW508</b>		RS-232	8	TxD, RxD, GND	-	-	-	-
<b>XW511i</b>		RS-485	4	Data+, Data-	-	-	-	-
<b>XW514</b>			8		-	-	-	-





# 4. 2000 series PAC



**WP-2241-CE7 (WinCE 7.0)**  
**LP-2241 (Linux Kernel 3.2.x)**

### Features:

- Embedded OS: WinCE 7.0, Linux kernel 3.2.x
- Cortex-A8, 32-bit (1.0 GHz) CPU
- 512 MB DDR3 SDRAM, 256/512 MB Flash
- 1× slot for microSD Card
- **4G LTE modem as Optional Add-on**
- 1 × VGA, 2× LAN, 2 × USB 2.0
- 2 × RS-232, 2 × RS-485
- 1 × slot for XV-board
- Redundant Power Inputs
- Fanless, Metal Housing
- Wide operating temperature range: -25 to +75°C

### Introduction:

The WP-2241-CE7 is a WinCE 7.0 embedded controller, and the LP-2241 is a Linux embedded controller. WP-2241-CE7 and LP-2241 has the same hardware specifications but comes with different OS. The PAC has one PCIe slot to add one 4G LTE modem and antenna to implement a simple 4G LTE connectivity solution.

### Appearance:

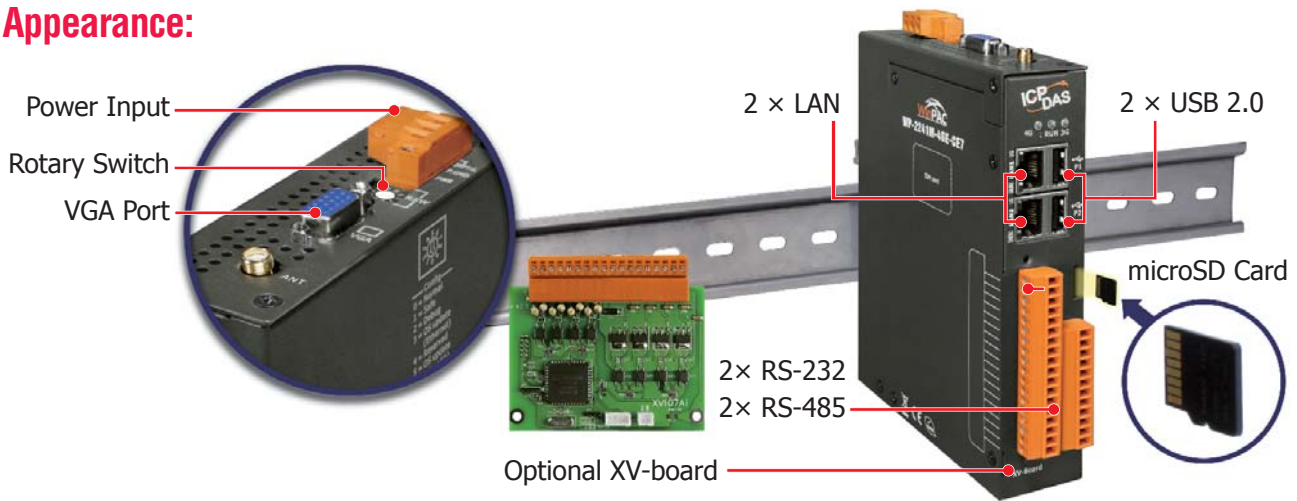

### I/O Expansion:

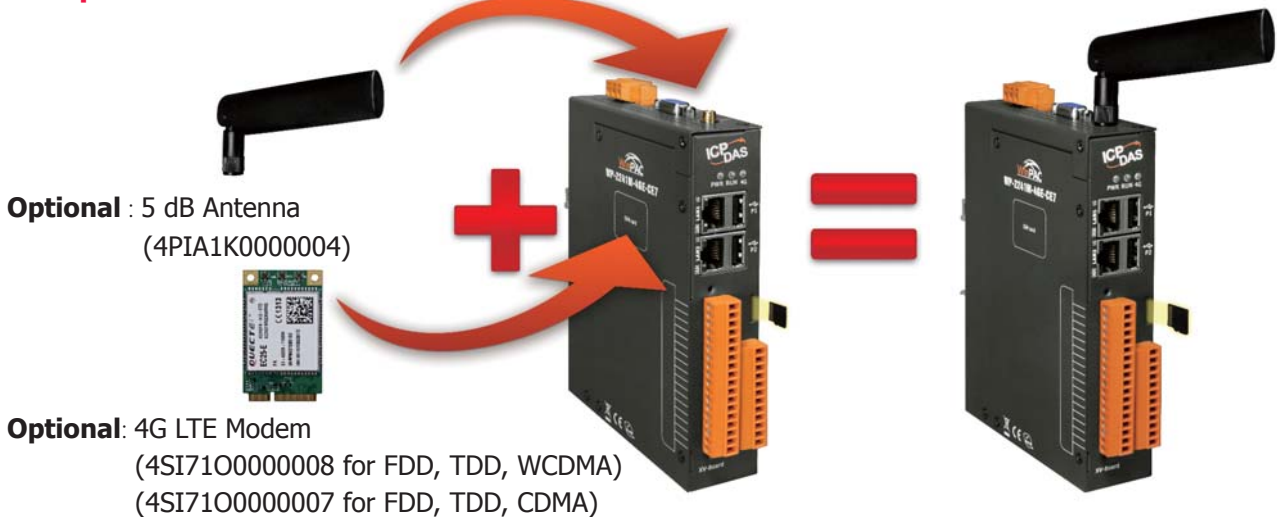



**XP-2031-CE6 (WinCE 6.0)**  
**LX-2031 (Linux Kernel 3.2.x)**

**Features:**

- Embedded OS: WinCE 6.0, Linux kernel 3.2.x
- x86, 32-bit dual-core (1.0GHz) CPU
- 2 GB DDR3 SDRAM, 32 GB SSD Flash
- 1 × slot for CF Card
- 1 × VGA, 2 × LAN, 4 × USB 2.0
- 4 × RS-232/422/485 Ports
- 1 × slot for XV-board
- Redundant Power Inputs
- Fanless, Metal Housing
- Wide operating temperature range: -25 to +75°C

**Introduction:**

The XP-2031-CE6 is a WinCE 6.0 embedded controller, and the LX-2031 is a Linux embedded controller. XP-2031-CE6 and LX-2031 has the same hardware specifications but comes with different OS.

**Appearance:**

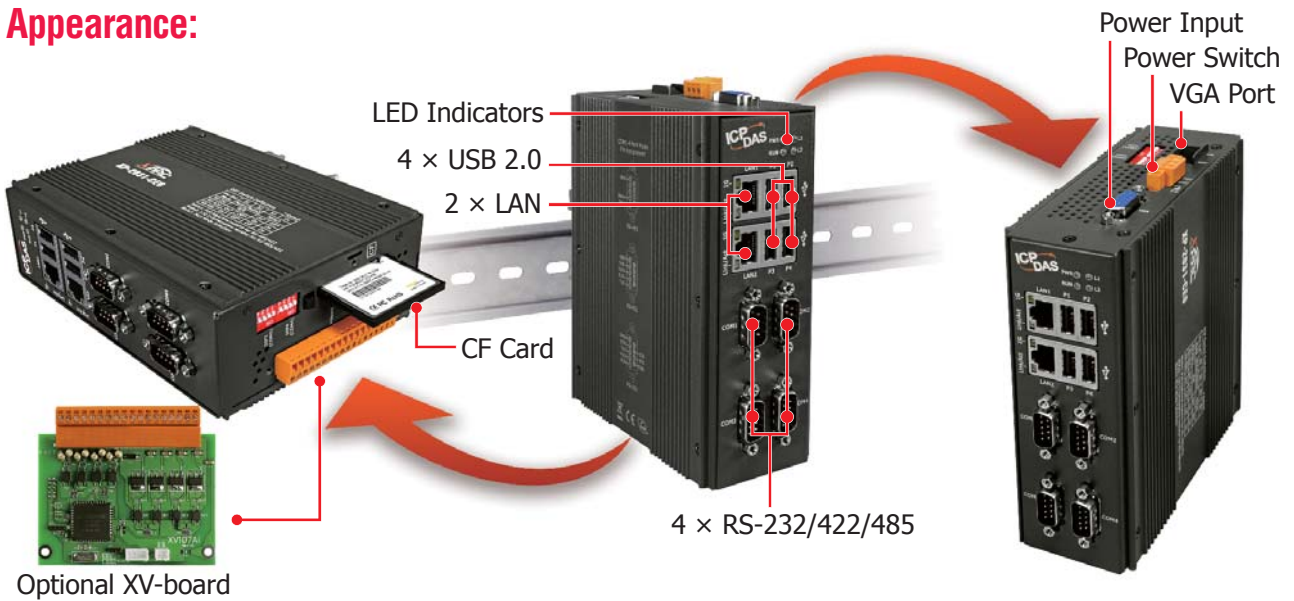

**I/O Expansion:**

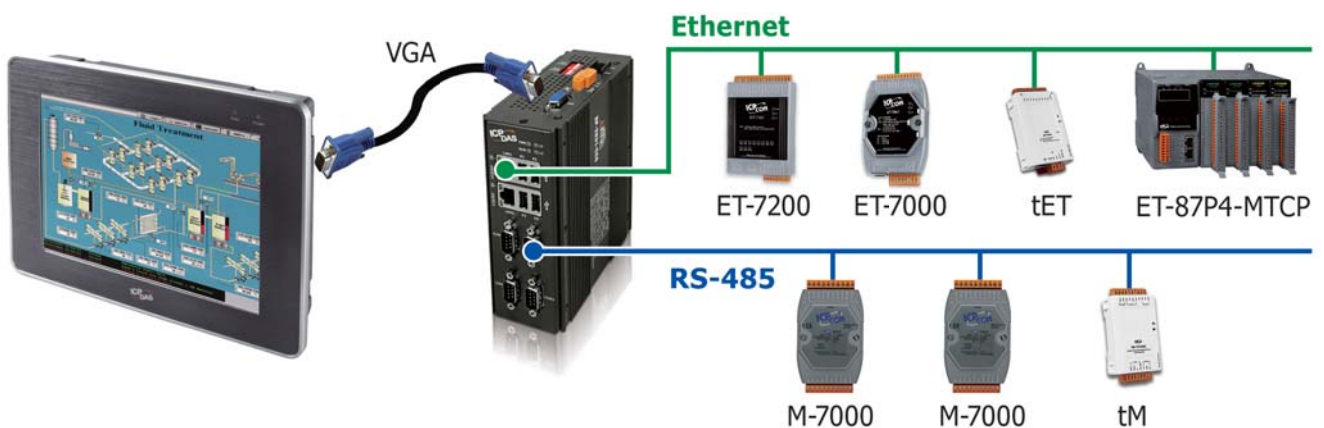



# 5. iBPC Series BoxPC

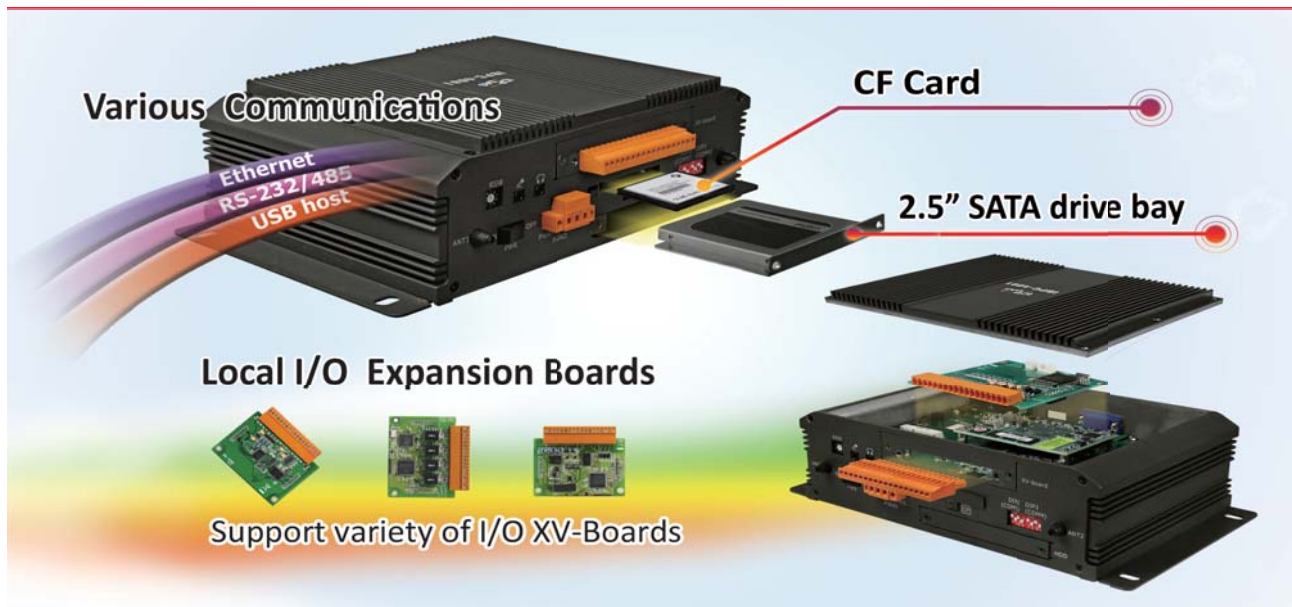

iBPC series is a fanless embedded box PC, wide operating temperature and wide range voltage capability, allow it run in the harsh environments.

iBPC series comes with the same interfaces: four RS-232/422/485 ports, VGA, HDMI, Audio, dual Gigabit Ethernet LAN ports and four high-speed USB 2.0. And there are various CPU options: iBPC-4081 is with one Intel® ATOM Quad Core 1.91Ghz Processor E3845 (with 4GB on-board memory), iBPC-4041 is with one Intel® i3-6100U processor (with one DDR4 SO-DIMM slot)

Two SMA type connector opening for antenna, optional I/O expansion board (XV-board), provides high protection I/O, +10 ~ 30 VDC power input connector, and one power switch. One 2.5" SATA HDD drive bay is also set up in the embedded computer to possess sufficient storage.

## Features:

### 1 Powerful Hardware Design

- iBPC-4081: Intel® Atom E3845 CPU (with 4 GB on-board memory)
- iBPC-4041: Intel® i3-6100U CPU (with one DDR4 SO-DIMM slot)
- 2 × 10/100/1000M Ethernet and 4 × USB 2.0 port
- One 2.5" SATA drive bay and 1 CF socket
- Ultra-Rugged Construction and Reliable Design
- Supports VGA and HDMI dual display
- RS-232/422/485 port
- I/O Expansion Bus for XV-board
- One Mini PCI Express Card slot
- Operating Temperature: -25 ~ +70°C

### 2 Local I/O Expansion Board

The iBPC-4081 can support one an I/O expansion card, which allow you implement various I/O functions.

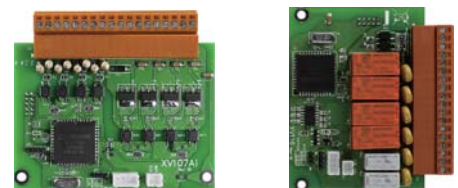

### 3 Remote I/O Module and Expansion Unit

With the built-in RS-485 and Ethernet ports, the iBPC-4081 can connect RS-485/Ethernet remote I/O units (RU-87Pn/ET-87Pn) or modules (I-7000/M-7000/ET-7000).



#### 4 Multiple Communication Interfaces

iBPC series provides different communication interfaces, easy to expand various I/O modules or connect to external devices.

1. Ethernet
2. RS-232/485
3. USB host
4. CAN Bus

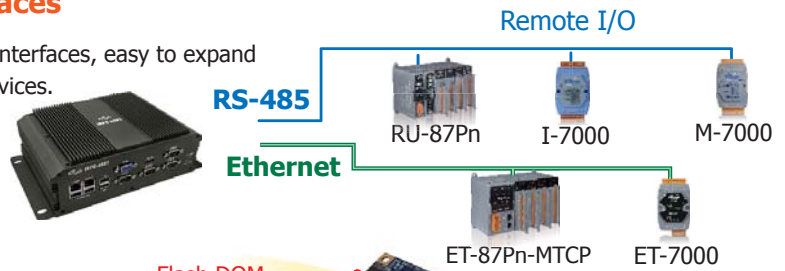

#### 5 Various Memory Storage Options

iBPC series provides various memory storage options.

- CF card: Portable data logging applications.
- 2.5" SATA drive bay or mSATA Flash: Rugged storage and shock absorption.

Flash DOM  
(Mini PCIe interface)

CF Card

2.5" SATA drive bay

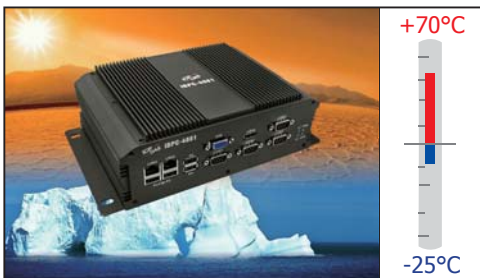

#### 6 Highly Reliable Under Harsh Environment

Our  $\mu$ PACs operate in a wide range of temperature and humidity.

- Operating Temperature: -25 ~ +70°C
- Storage Temperature: -40 ~ +75°C
- Humidity 10 ~ 90% RH (non-condensing)

#### Appearance:

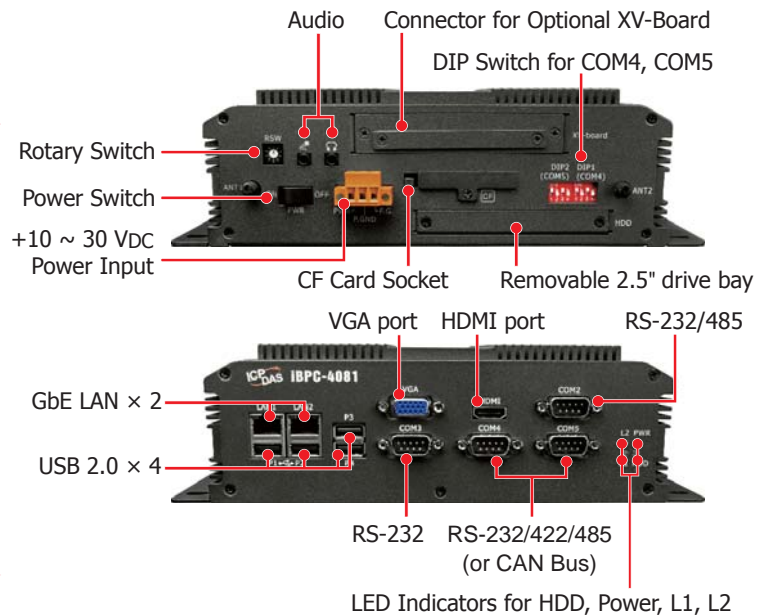
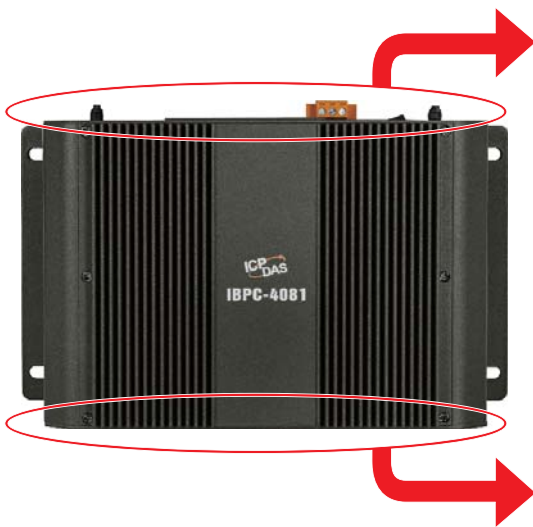

Standard box PC

Model Name	CPU	SDRAM	VGA/HDMI Resolution	Ethernet	RS-232/422/485	CAN Bus	USB 2.0	I/O Expansion	Audio Port
iBPC-4081	E3845, 1.91 GHz, quad core	4 GB DDR3 on-board	1280 × 1024 to 1920 × 1080	2	4	-	4	XV-Board	Yes
iBPC-4081-CAN					2	2			
iBPC-4041	i3-7100U, 2.3 GHz, dual-core	One DDR4 SO-DIMM slot			4	-			
iBPC-4041-CAN					2	2			

# Panel Products

# 2

	Panel Products (PAC family with LCD)	P 2-1
1	iPPC (Industrial Panel PC)	P 2-2
2	ViewPAC	P 2-4
3	IWS (InduSoft)	P 2-8
4	SmartView	P 2-11
5	TouchPAD, ViewPAD	P 2-14
6	Industrial Modbus LED Display	P 2-21
7	Touch Monitor	P 2-23



# Panel Products

## PAC family with LCD

	iPPC (Industrial Panel PC)	
Model Name	iPPC-6731-WES7 iPPC-6831-WES7	iPPC-x701-WES7 iPPC-x801-WES7
Pictures		
OS	WES7 (Windows Embedded Standard 7)	
Software Development Tool	DLL for Visual Studio .NET	
CPU	E3827 (1.75 GHz, 64-bit dual core) or E3845 (1.91 GHz, 64-bit quad core)	
LCD	10.4" ~ 17"	
I/O Expansion	I/O Slots (for I-8K, I-87K modules), RS-232/485, Ethernet	RS-232/485, Ethernet

	ViewPAC			IWS	SmartView
Model Name	VP-25W1	VP-4131	VP-x201-CE7/VP-x231-CE7	IWS-x201-CE7	SV-x201
Pictures					
OS	WinCE 5.0		WinCE 7.0		-
Software Development Tool	VS .NET 2005/2008 ISaGRAF, Win-GRAF, InduSoft			InduSoft (SCADA)	Creator
CPU	Marvell PXA270 (520 MHz)		Cortex-A8 (720 MHz or 1 GHz)		-
LCD	5.7"/10.4" TFT LCD with Touch Panel		7" ~ 15" TFT LCD with Touch Panel		
I/O Expansion	I/O Slots (for I-8K, I-87K modules), RS-232/485, Ethernet			RS-232/485, Ethernet	

	TouchPAD			ViewPAD		
Model Name	TPD-703 TPD-703-64	TPD-43x-H TPD-43x-H-EU	TPD-280-H TPD-283-H TPD-28x-Mx	VPD-13x-H VPD-13xN-H	VPD-14x-H VPD-14xN-H	VPD-173x VPD-173x-64
Pictures						
OS	N/A					
Software Development Tool	HMIWorks (C language, Ladder)					
CPU	32-bit RISC CPU					
LCD	7" TFT LCD with Touch Panel	4.3" TFT LCD with Touch Panel	2.8" TFT LCD with Touch Panel	3.5" TFT LCD with Touch Panel	4.3" TFT LCD with Touch Panel	7" TFT LCD With Touch Panel
I/O Expansion	RS-232/485 or Ethernet		RS-485 or Ethernet	RS-232/485, Ethernet or XV-Board		

	Touch Monitor
Model Name	TP-2070/TP-3080/TP-4100/TPM-4100 TP-5120/TP-6150/TP-7170
Pictures	
Size	7", 8.4", 10.4", 12.1", 15", 17"
Touch Screen Function	Combo RS-232 & USB interface
Driver Support	Windows 2000/XP/7/WES7, WinCE 5.0/6.0/7.0, Linux

	Industrial Modbus LED Display
Model Name	iKAN series
Pictures	
Character Sets	16-bit Unicode or 7-bit ASCII
Ethernet Port	RJ-45 × 1, 10/100 Base-TX, Protocol: Modbus TCP Slave, Max. 8 connections
COM Port	RS-232 or RS-485 × 1, Protocol: Modbus RTU Slave



# 1. iPPC

## Industrial Panel PC



### Features:

- LCD Size: 10.4", 12.1", 15", 17" with Touch Panel
- E3827 (1.75 GHz) or E3845 (1.91 GHz) CPU
- WES7 (Windows Embedded Standard 7)
- Support eLogger HMI (free)
- 3 I/O Expansion Slots (optional)
- NEMA 4/IP65 Compliant Front Panel
- Ultra-Rugged Construction and Reliable Design
- Operating Temperature: -20°C ~ +60°C

### Introduction:

The iPPC series is WES7 based Panel PC that combine computing, I/O, and operator interface into a single unit, and provide the perfect solution for integrating HMI, data acquisition and control in an individual iPPC. It is equipped with an Intel Atom E3827 or E3845 CPU, three I/O expansion slots option, TFT LCD and a variety of connectives including dual Gigabit Ethernet, USB port, RS-232 and RS-485 interface. The operating system is pre-installed in the built-in mSATA SSD, and the storage can be expanded from a Compact Flash slot. Local I/O slots are available to use our I-8K and I-87K series I/O modules and remote I/O expansion is available to use our Ethernet I/O modules and RS-485 I/O modules. Designed for panel mount installation, the front panel is NEMA 4/IP65 rated and can withstand sprayed water, humidity and extreme dust. Designed to operate over a wide -20°C ~ 60°C ambient temperature range, the fanless design offers the ultimate in reliability with no moving parts.

Since WES7 has the same Win32 API as Windows 7, most popular applications on desktop can run on WES7 based Panel PC.

### WES7 Embedded OS:

WES7 has the same Win32 API as Windows 7. Most popular applications on desktop can be run on WES7. It's also compatible with rich Windows IDEs, such as Visual studio, Delphi, Borland C++ Builder, etc.



- Full Win32 API
- Remote Desktop Protocol 5.1
- Silverlight 5
- Enhanced Write Filter
- MS SQL Server 2012 Express
- .NET Framework 3.5 SP1, 4.0, 4.5

### Selection Guide:

# iPPC -



**Display**  
 4: 10.4" LCD  
 5: 12.1" LCD  
 6: 15" LCD  
 7: 17" LCD



**CPU Type**  
 7: E3827  
 8: E3845



**I/O slot**  
 0: w/o slot  
 3: 3 slot



**Software**  
 1: Standard  
 (VC, VB, C#)



**OS**  
 WES7

Panel PC with x86 CPU and WES7 OS



Model Name	LCD	CPU	Flash	RAM	Memory Expansion	Ethernet	I/O slot	COM port
iPPC-4801-WES7	10.4" (800 × 600)	E3845 (1.91 GHz, quad core) or E3827 (1.75 GHz, dual core)	32 GB	4 GB or 2 GB	CF	1	-	2
iPPC-4701-WES7						1		2
iPPC-5801-WES7	12.1" (800 × 600)					1		3
iPPC-5701-WES7						1		3
iPPC-6801-WES7	15" (1024 × 768)					2		3
iPPC-6701-WES7						2		3
iPPC-7801-WES7	17" (1280 × 1024)					2		3
iPPC-7701-WES7						2		3

Model Name	LCD	CPU	Flash	RAM	Memory Expansion	Ethernet	I/O slot	COM port
iPPC-6831-WES7	15" (1024 × 768)	E3845 (1.91 GHz, quad core)	32 GB	4 GB	CF	2	3	3
iPPC-6731-WES7		E3827 (1.75 GHz, dual core)		2 GB				

### Appearance:

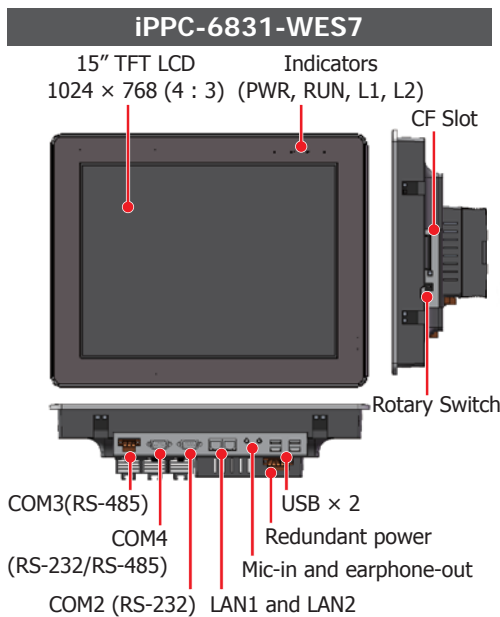

### I/O Expansion:

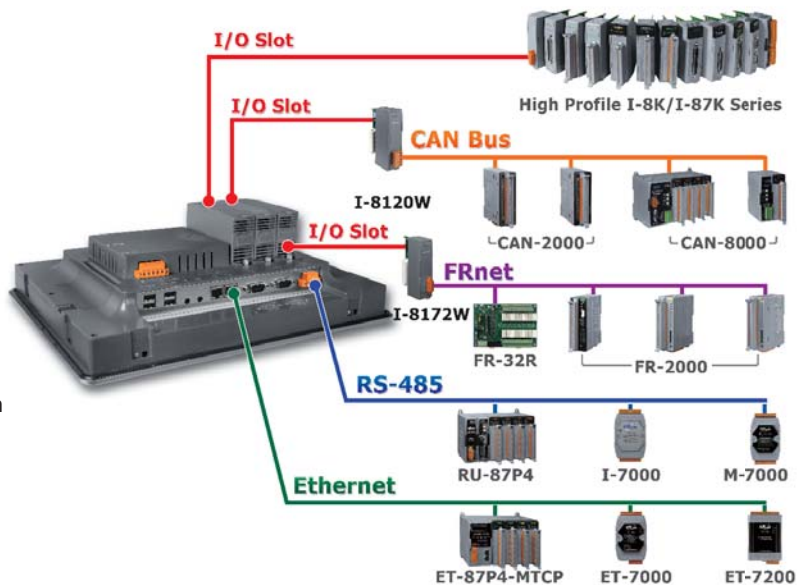

## 2. ViewPAC

Introduction:

# ViewPAC Family

**All-in-one**

**Rich Development Tools**  
ISaGRAF, InduSoft, Microsoft Visual Studio.net

**Colorful, IP65 Waterproof Touch Screen**

**Various Communications**  
Ethernet, RS-232/485, USB host, CAN bus, GSM/GPRS/GPS, ZigBee

**I/O Slots**  
More than 60 types of I/O are supported

ViewPAC is an ARM-based PAC that combines a display, an I/O module and control in a single unit, and provide the perfect solution for integrating HMI, data acquisition and control in an individual PAC. Normally, HMIs and controllers operate separately.

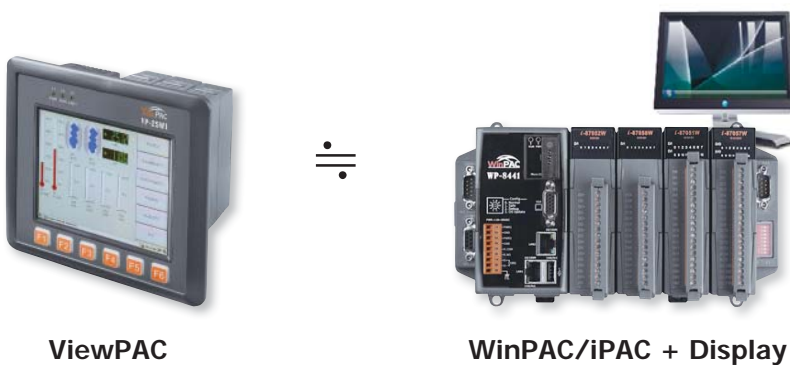



• Features

1. A variety of CPU and OS options for selection



- Full Win32 API
- Remote Desktop Protocol 5.1
- Silverlight 5
- Enhanced Write Filter
- MS SQL Server 2012 Express
- .NET Framework 3.5 SP1,
- .Net Framework 4.0, and
- .Net Framework 4.5

2. LCD Display

5.7", 7", 8.4", 10.4", 12.1", 15" TFT LCD with touch panel



3. I/O Slots

The I/O slots support parallel bus (high profile I-8K series) and serial bus (high profile I-87K series) type I/O modules, and there are more than 60 kinds of module available for AI, AO, DI, DO, counter input, frequency input, PWM output, motion control, memory, and communication, etc.



4. Multiple Communication Interfaces

Several different types of communication interface are available that enable I/O modules to be expanded and connected to external devices:

1. Ethernet
2. RS-232/485
3. USB host
4. CAN bus
5. GSM/GPRS/GPS
6. ZigBee



## Selection Guide:

# VP -



### Display

- 1: 5.7" LCD
- 2: 7" LCD
- 3: 8.4" LCD
- 4: 10.4" LCD
- 5: 12.1" LCD
- 6: 15" LCD



### CPU Type

- 1: PXA270
- 2: Cortex-A8



### I/O Slot

- 0: w/o slot
- 3: 3 slot



### Software

- 1: Standard
- 7: ISaGRAF
- 8: Win-GRAF



### OS

- CE: WinCE7



### Standard ViewPAC



Model Name	LCD	OS	CPU	Flash	RAM	Memory Expansion	Ethernet	RS-232/RS-485	I/O slot
VP-1231-CE7	5.7" (640 × 480)	CE7	Cortex-A8 (720 MHz)	256 MB	512 MB	microSD	1	2	3
VP-2201-CE7	7" (800 × 480)							2	-
VP-3201-CE7	8.4" (800 × 600)							2	-
VP-4231-CE7	10.4" (800 × 600)							2	3
VP-4201-CE7			3			-			
VP-5201-CE7	12.1" (800 × 600)		3			-			
VP-6231-CE7	15" (1024 × 768)		2			3			
VP-6201-CE7			3			-			



### Win-GRAF Based ViewPAC



Model Name	LCD	OS	CPU	Flash	SDRAM	Ethernet Port	RS-232/RS-485	I/O Slot
VP-1238-CE7	5.7" (640 × 480)	CE7	Cortex-A8 (720 MHz)	256 MB	512 MB	1	2	3
VP-2208-CE7	7" (800 × 480)						2	-
VP-3208-CE7	8.4" (800 × 600)						2	-
VP-4238-CE7	10.4" (800 × 600)						2	3
VP-4208-CE7			3				-	
VP-5208-CE7	12.1" (800 × 600)		3				-	
VP-6238-CE7	15" (1024 × 768)		2				3	
VP-6208-CE7			3				-	

### Standard ViewPAC

Model Name	LCD	OS	CPU	Flash	RAM	Dual Battery Backup SRAM	Ethernet Port	RS-232/RS-485	I/O Slot
VP-25W1	5.7" (640 × 480)	CE5	PXA270 (520 MHz)	96 MB	128 MB	microSD	1	2	3
VP-4131	10.4" (800 × 600)			128 MB					

### ISaGRAF Based ViewPAC

Model Name	LCD	OS	CPU	Flash	RAM	Dual Battery Backup SRAM	Ethernet Port	RS-232/RS-485	I/O Slot
VP-25W7	5.7" (640 × 480)	CE 5.0	PXA270, 520 MHz	96 MB	128 MB	512 KB	1	2	3
VP-4137	10.4" (800 × 600)			128 MB					

Appearance:

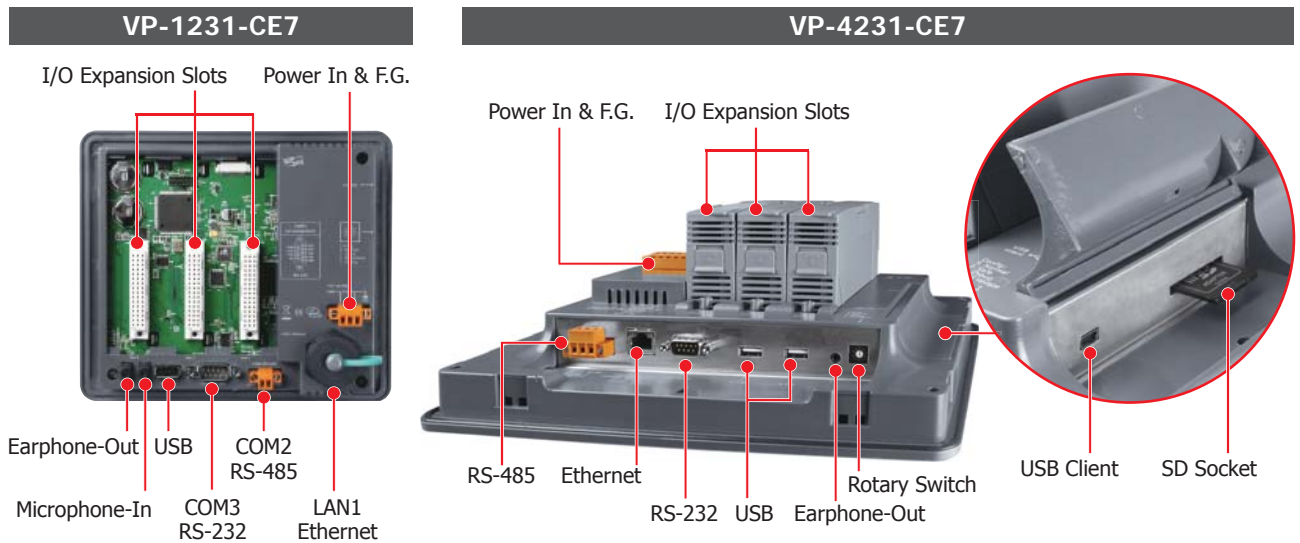
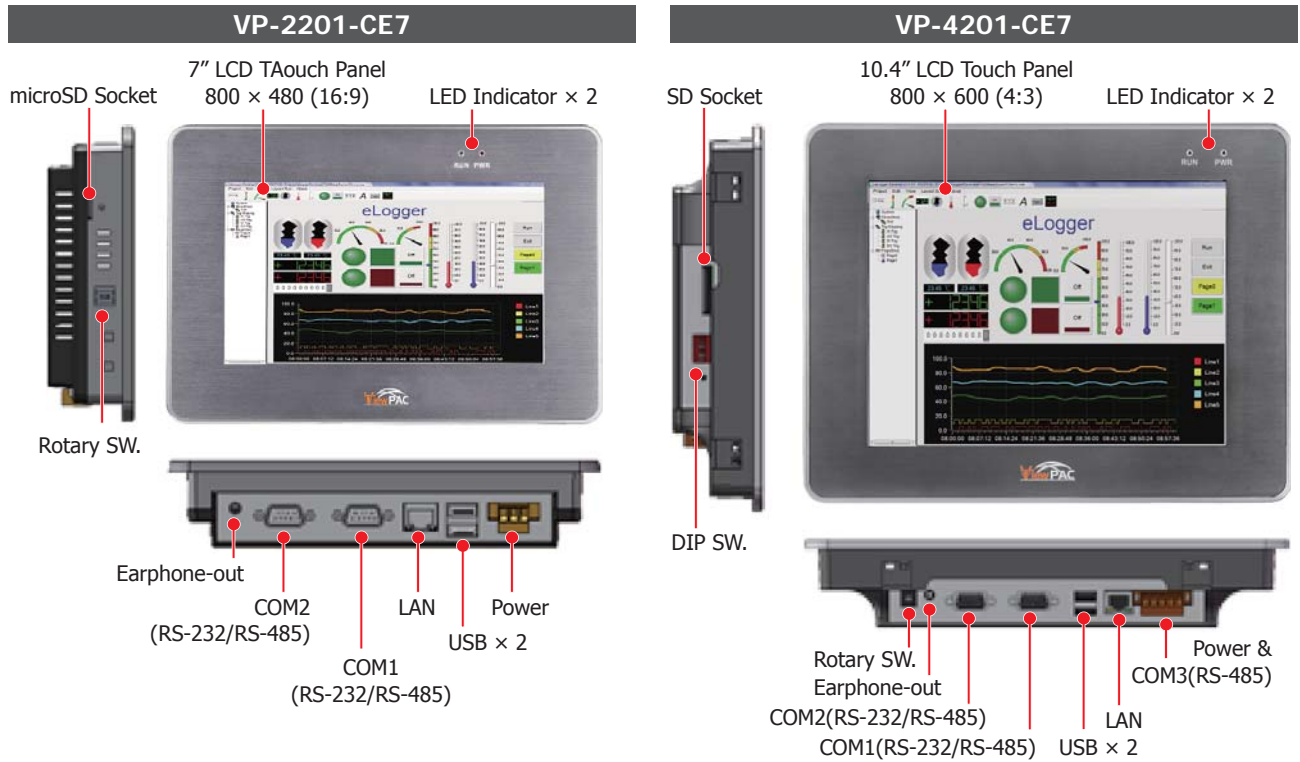

Application:

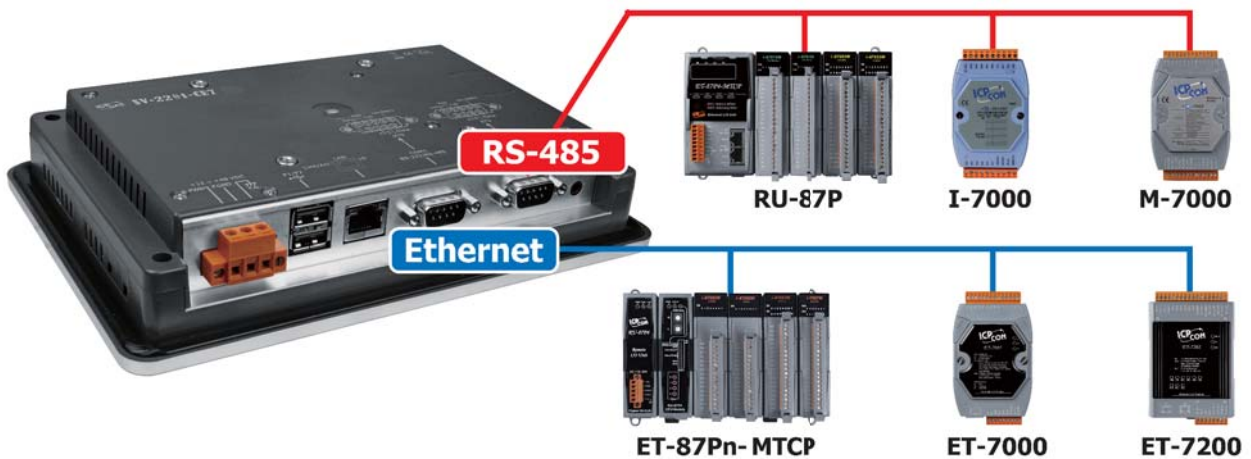



# 3. IWS (InduSoft)



## Features:

- InduSoft Runtime Inside
- Support Modbus, OPC, TCP/IP Client/Server
- DCON Driver for ICP DAS I/O modules provided
- Makes connectivity for the "internet of things" and mobile devices easily
- 7"/8.4"/10.4"/12.1"/15" LCD
- Resolution: 800 × 480 ~ 1024 × 768
- Resistive Touch Panel
- Cortex-A8 CPU
- Windows CE 7.0
- NEMA 4/IP65 Compliant Front Panel
- Operating Temperature: -10 ~ +60°C
- VESA Mounting

## Introduction:

The IWS PAC series is the new generation WinCE 7.0 based InduSoft PAC of ICP DAS. It combines an ARM-based CPU board, TFT LCD touch screen to create a ruggedized, flat panel computer perfect for a variety of control and HMI applications. It provides a variety of connectives including Gigabit Ethernet, USB port, RS-232 and RS-485. The operating system is pre-installed in the on-board Flash memory. Remote I/O expansion is available using our Ethernet I/O modules, RS-485 I/O modules, Wi-Fi and ZigBee wireless I/O modules. Designed for panel mount installation, the front panel is NEMA 4/IP65 rated and can withstand sprayed water, humidity and extreme dust. Designed to operate over a wide -10°C ~ 60°C ambient temperature range, the fanless design offers the ultimate in reliability with no moving parts.

## InduSoft Features

### Alarms

In addition to the many alarm functions you expect from InduSoft Web Studio, v7.1 also sends online alarms or reports using multi-media formats like PDF.

Alarms are real-time and historical; log data in binary format or to any database. Use remote notification to have alarms sent right to your inbox, printer, or smartphone! Custom Alarm fields allow you to customize up to 10 additional fields to the history of alarms.

### Recipe / Report

Save time and maintain consistency by automating part parameters or production quantities with flexible recipe management tools. Create clear, concise reports in plain text, RTF, XML, PDF, HTML, and CSV or integrate with Microsoft Office programs such as Excel. Get the data you need, in the format you need it, to make informed decisions, fast. InduSoft has also partnered with Ocean Data Systems to offer further reporting capabilities through Dream Report for InduSoft Web Studio, available as an add-on.

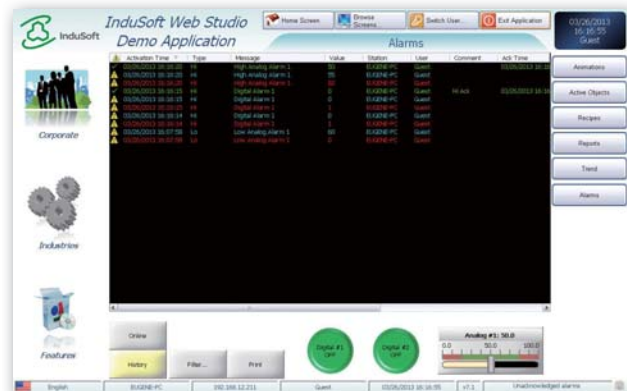

1 PAC Products and BoxPC

2 Panel Products

3 Remote I/O Module and Unit

4 IIoT

### Trend

Real-time and Historical trends, and SPC functionality are supported. Log data in binary format. or to any local or remote SQL database. Color or fill trends with graphic elements to enhance clarity of data. Date/Time based or numeric (X/Y plot) trends give you the flexibility to display information that best suits your application. InduSoft Web Studio supports vertical and horizontal trending.

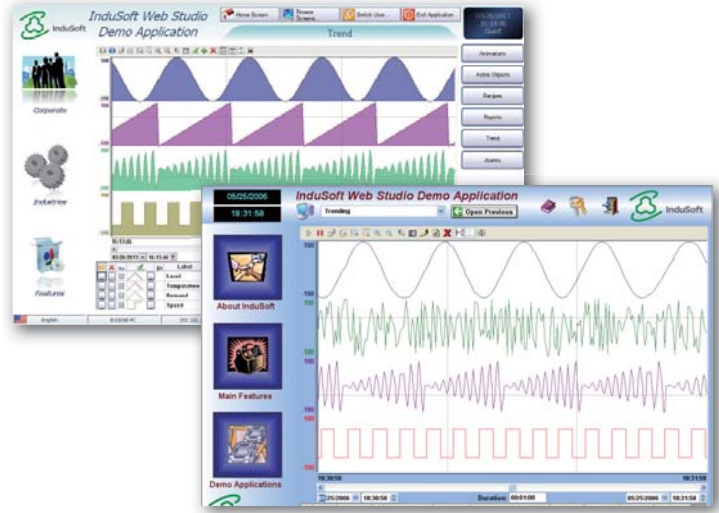

### Database

Connect to any SQL database (MS SQL, MySQL, Sybase, Oracle), or MS Access or Excel, and ERP/MES systems (including SAP), even from Windows Embedded CE. InduSoft Web Studio is flexible, offering a built in interface that doesn't require knowledge of SQL (for trends, alarms/events, grid and other objects). Use any SQL statement you need, anywhere you need it.



### Driver / OPC

provides over 240 native communication drivers for PLCs, temperature controllers, motion controllers, bar code/2D/RFID readers, and many other devices. Use these built in drivers, or connect to an OPC server. InduSoft driver toolkits even allow you the flexibility to build your own drivers.



### Thin Clients

Remotely view screens as web pages using Internet Explorer web browser, or InduSoft Secure Viewer. Without installing any additional software and provide embedded firewall, remote client command disabled and login authority functions to protect the system security.

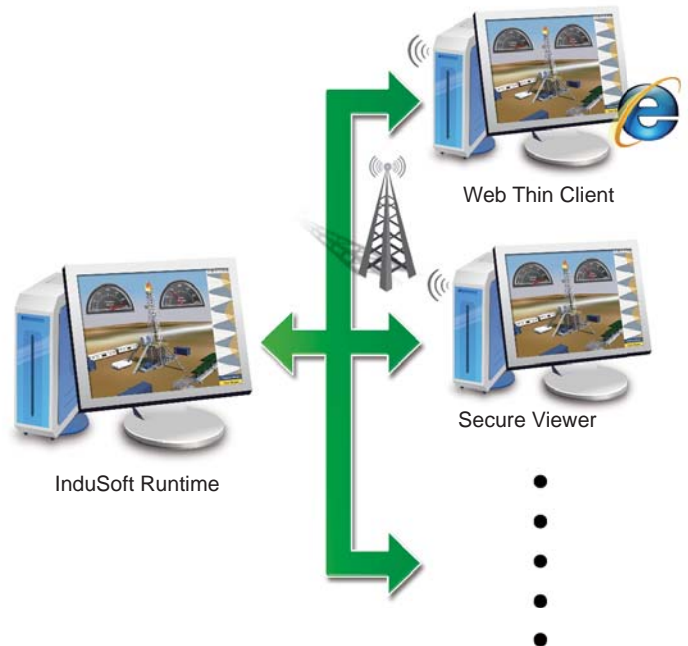

## Selection Guide:

# IWS -



**Display**  
 2: 7" LCD  
 3: 8.4" LCD  
 4: 10.4" LCD  
 5: 12.1 LCD  
 6: 15" LCD



**CPU Type**  
 2: Cortex-A8



**I/O Slot**  
 0: w/o slot



# - CE7

InduSoft Based ViewPAC



Model Name	LCD	OS	CPU	Flash	RAM	Memory Expansion	Ethernet	RS-232/RS-485	I/O slot
IWS-2201-CE7	7" (800 × 480)	CE7	Cortex-A8 (720 MHz)	256 MB	512 MB	microSD	1	2	-
IWS-3201-CE7	8.4" (800 × 600)		Cortex-A8 (1 GHz)			SD			
IWS-4201-CE7	10.4" (800 × 600)								
IWS-5201-CE7	12.1" (800 × 600)								
IWS-6201-CE7	15" (1024 × 768)								

**Note:** IWS is InduSoft-CE300R (300 tags, 3 drivers) embedded. InduSoft-CE1500R (1500 tags, 3 drivers) is optional.

## Appearance:

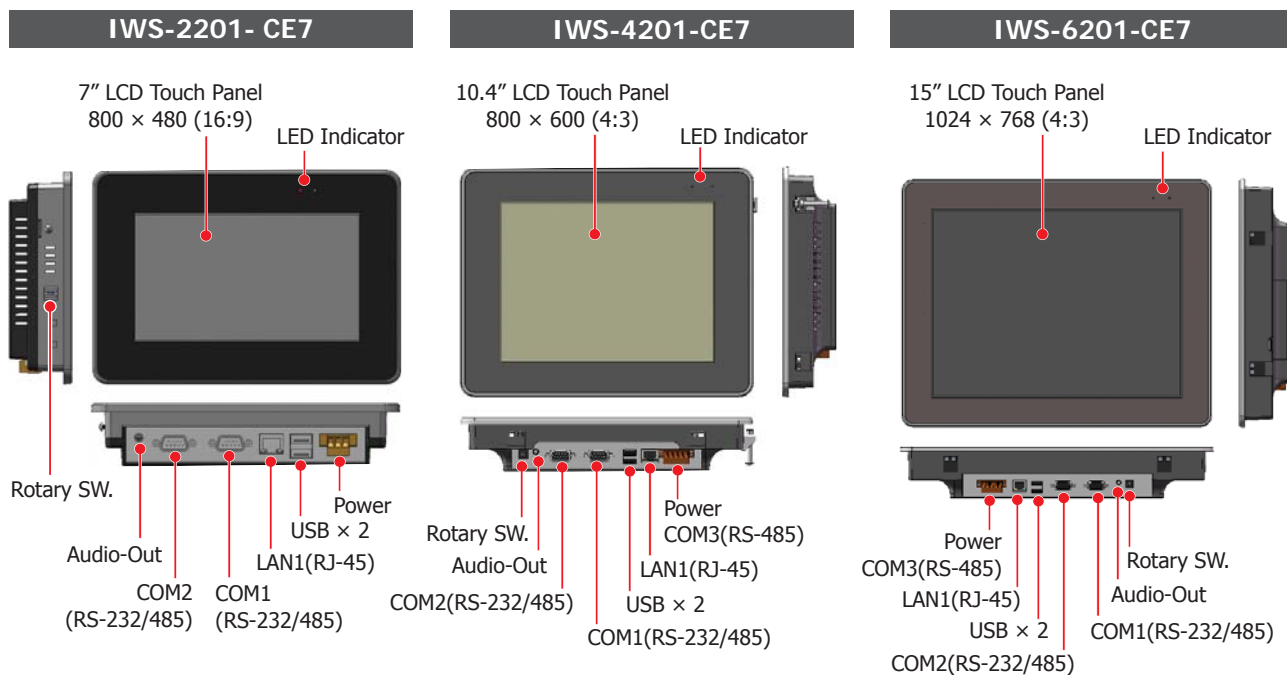



# 4. SmartView

- SV-2201
- SV-3201
- SV-4201
- SV-5201
- SV-6201



### Features:

- Provides HMI IDE Software: Creator
- Supports Active M2M Transmission Mechanism: MQTT
- Makes connectivity for the "internet of things" devices easily.
- 7"/8.4"/10.4"/12.1"/15" LCD
- Resolution: 800 × 480 ~ 1024 × 768
- Resistive Touch Panel
- NEMA 4/IP65 Compliant Front Panel
- Operating Temperature: -10 ~ +60°C

### Introduction:

The **SmartView** series of devices from ICP DAS combines a RISC-based CPU board, a TFT LCD touch screen and a ruggedized flat panel PAC, and includes a wide range of software, such as HMI and MQTT, which are perfect for a variety of control and HMI applications. The **SmartView** series provides a variety of connection options, including Gigabit Ethernet, RS-232 and RS-485 ports. The operating system is pre-installed in the onboard Flash memory, and Remote I/O expansion is available using ICP DAS Ethernet I/O modules and RS-485 I/O modules. The SmartView series is designed for panel-mount installation. The front panel is NEMA 4/IP65 rated, meaning that it can withstand sprayed water, humidity, and extreme dust, and can be operated over a wide ambient temperature range of -10°C to +60°C. The fan-less design provides the ultimate in reliability with no moving parts.

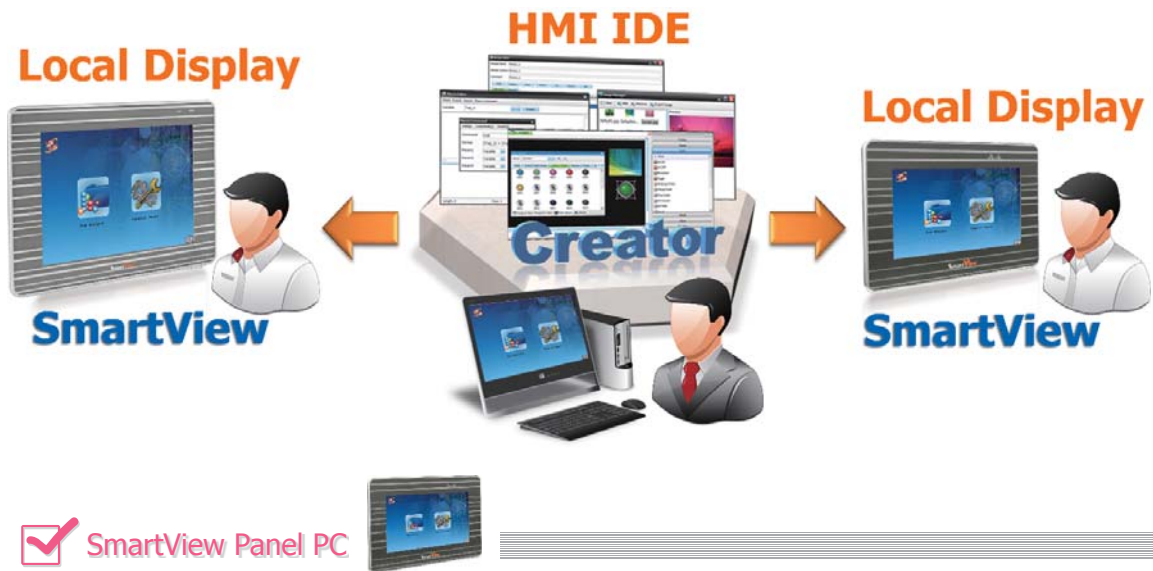

SmartView Panel PC

Model Name	LCD	Flash	RAM	Memory Expansion	Ethernet	I/O slot	COM port
SV-2201	7" (800 × 480)	256 MB	512 MB	microSD	1	-	2
SV-3201	8.4" (800 × 600)	512 MB		SD			
SV-4201	10.4" (800 × 600)						
SV-5201	12.1" (800 × 600)						3
SV-6201	15" (1024 × 768)						

## Provides Creator: Powerful HMI IDE Software

**Creator** is a professional development toolkit especially designed for the **SmartView** (or HA-401) series of devices produced by ICP DAS. **Creator** can be used to integrate several commonly used PLC communication protocols, providing rich and flexible object editing tools that allow easy navigation and adjustment of window management, repeated import and export of data in order to shorten the development process, simple uploading or updating of **SmartView** (or HA-401) projects using the built-in TCP transport, and the construction of control systems, ranging from a small and simple local control/monitoring application to management systems for large buildings, factories, and engine rooms, etc.

The **Creator** also supports "Internet of Things" transmission "MQTT", and I/O status simulation in designing process. Combined with these features, **Creator** can dramatically save development time and make the **SmartView** development more efficiently.

### Creator Features:

- Supports Commonly Used PLC Communication Protocols
- Easy to Create HMI Projects Without the Need for Complex Coding
- Diverse Range of HMI Objects and Functions: Alarm, Schedule, Recipe, Data Log, Macro...
- Update Projects via Ethernet
- Supports MQTT
- Supports Online/Offline Simulation
- Supports Multiple Languages: Traditional Chinese/Simplified Chinese/English
- Provides 36 Macro Commands for Logic Operations or Controls

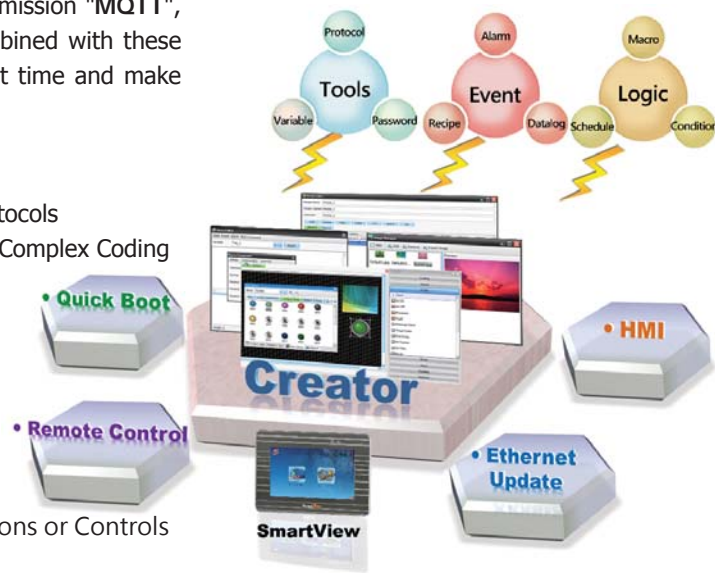

## Supports MQTT: Active M2M Transmission Mechanism

**MQTT** is a method of **Machine to Machine (M2M)** communication by writing and retrieving application-specific data (messages) to and from queues, without having a private, dedicated connection to link them. It simplifies and accelerates the integration of diverse applications data between **SmartView** under assured, secure and reliable exchange of information circumstance. Using **MQTT** in **SmartView** not only dramatically simplifies the creation and maintenance of Industrial application but also makes connectivity for the "internet of things" devices easily.

### MQTT Features:

- **Rapid, Seamless Connectivity**  
Rapid, seamless connectivity of information with a single, robust and trusted messaging backbone for dynamic heterogeneous environments.
- **Secure, Reliable Message Delivery**  
Secure, reliable message delivery that preserves message integrity and minimizes risk of information loss.
- **High-performance Deployment**  
High-performance and scalable message transfer to meet the demands of today's enterprise and beyond.
- **Simplified Management and Control**  
Simplified management and control for better control and usability.
- **Cost Effective**  
Cost effective of ownership by reducing cost of integration and accelerating time to deployment.

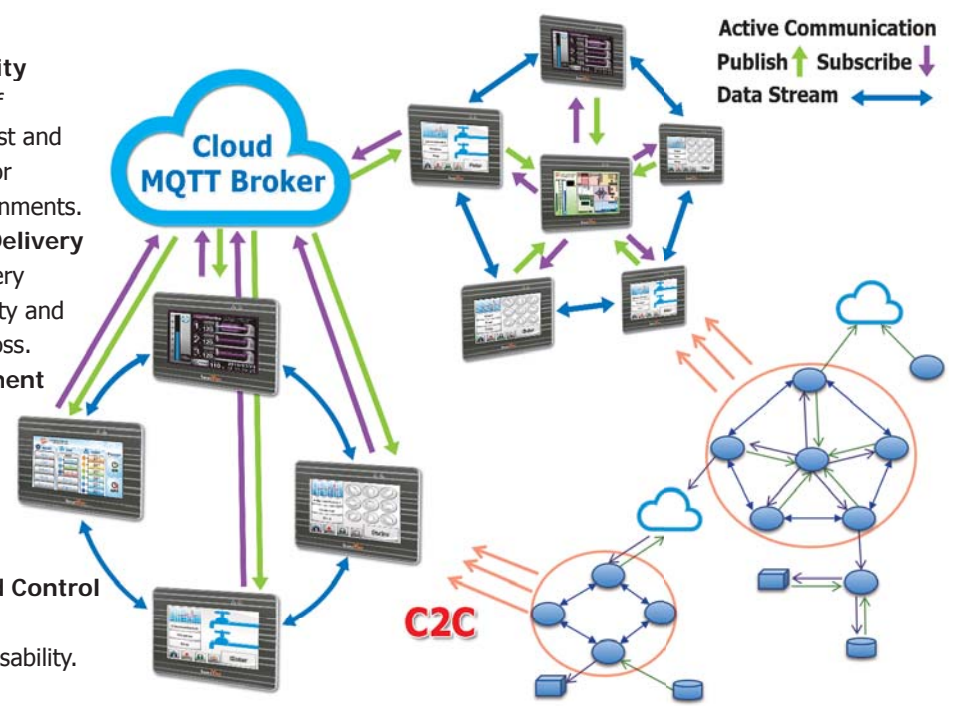

**Selection Guide:**

**SV -**



**Display**  
 2: 7" LCD  
 3: 8.4" LCD  
 4: 10.4" LCD  
 5: 12.1" LCD  
 6: 15" LCD



**CPU Type**  
 2: AM335x



**I/O Slot**  
 0: W/O SLOT



**Appearance:**

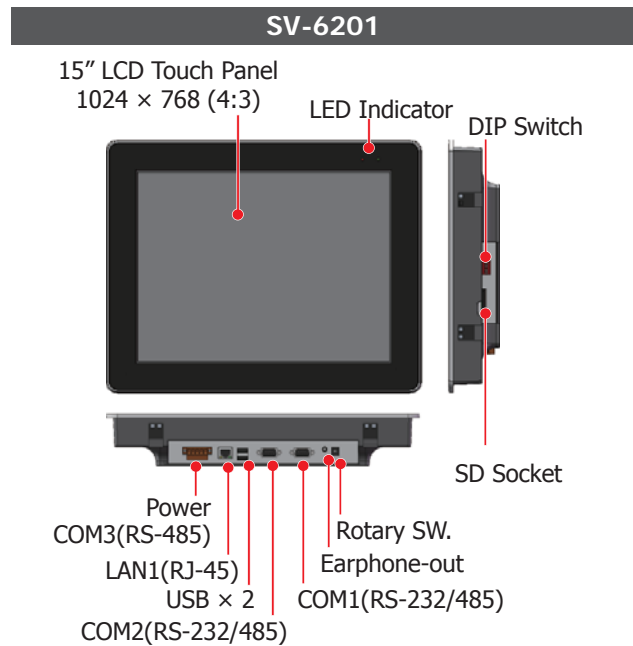
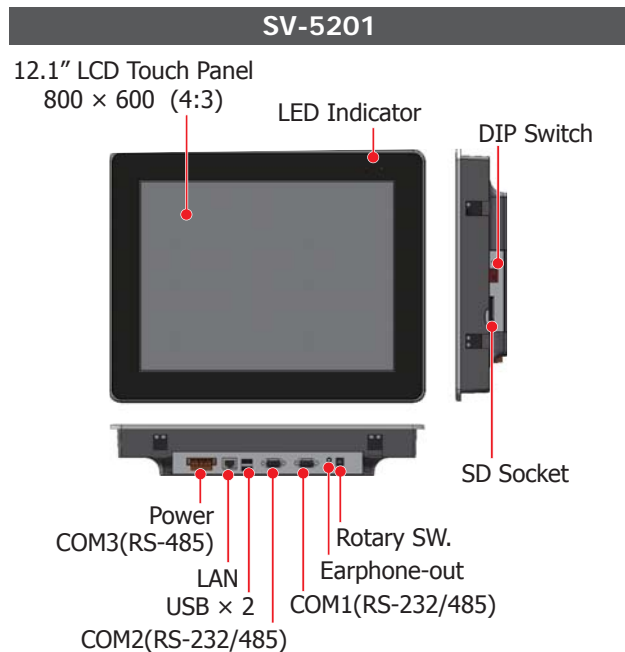
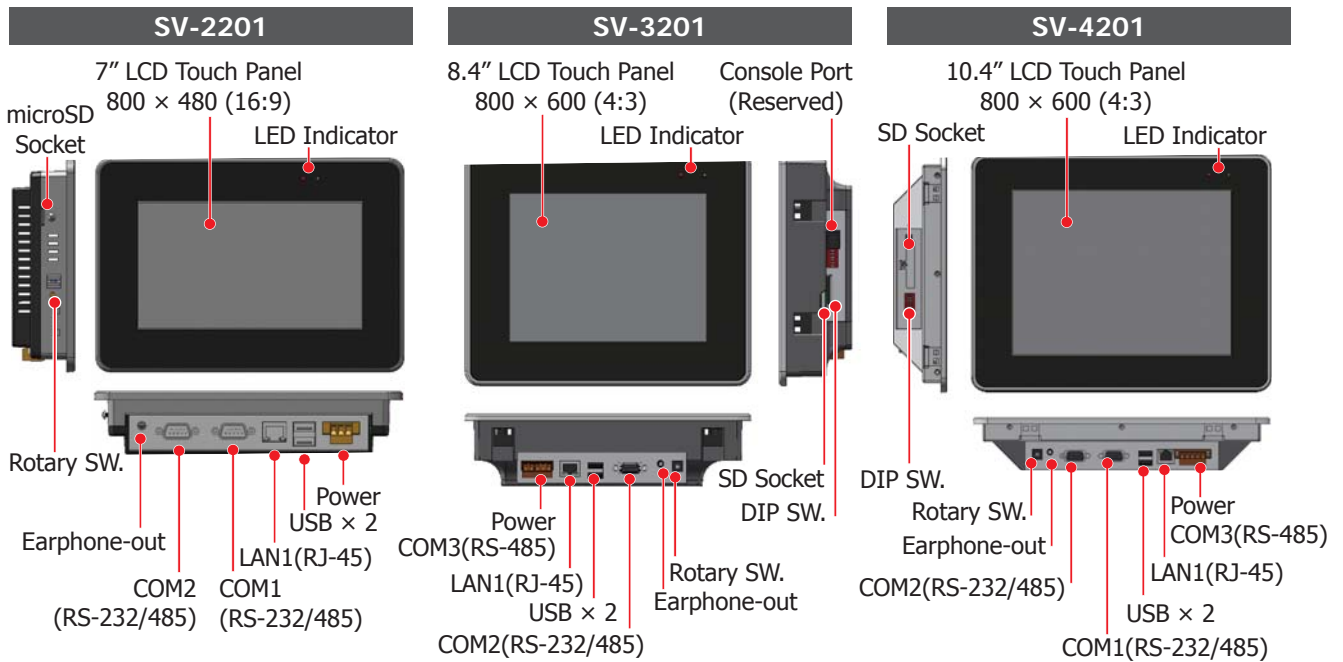



# 5. TouchPAD, ViewPAD

The Best Choice for Building/Factory/Machine/Home Automation

## Introduction:



ICP DAS provides two types of touch HMI devices, the TPD series and the VPD series. The TPD series is designed for home/building automation applications and the VPD series is designed for factory/machine automation applications. Both have many common features, such as a high-color high-resolution touch screen, RTC, and a variety of communication interfaces, including RS-232/RS-485 and Ethernet. However, each still has its own specific features for its respective target applications. For the TPD series, users can use an external wall box to help smoothly blend the TPD series device into decoration. For the VPD series, the rubber keypad, IP-65 waterproof front panel and DIN-Rail/panel mounting are designed for harsh environment, and are especially suitable for factories.



HMIWorks is a free development tool that can be used to design ladder diagrams for softPLC logic for TouchPAD. A single TouchPAD becomes a touch HMI device which runs ladder logics.

## Features:

- Excellent C/P ratio (cost/performance)
- High-color high-resolution touch screen
- Power over Ethernet (PoE)
- ESD Protection: 4 kV
- RTC (Real Time Clock)
- Buzzer
- Rubber Keypad (Option for VPD Series)
- Graphical user interface designer
- Free development tool: HMIWorks
- Support the C language and Ladder Designer
- Support user-defined third party protocol(C language)
- Modbus protocol enables remote control of I/O modules and integration with SCADA software
- RS-485 (including SelfTuner)/RS-232 (3 pins)
- Waterproof Front Panel ( VPD: IP65)
- Operating temperature: -20 ~ +50°C (2.8": -20 ~ +70°C; 7": -10 ~ +60°C)

• HMIWorks - Free Development Software

# HMIWorks *The development software for the TouchPAD and ViewPAD series*



HMIWorks is a free development software for TouchPAD and ViewPAD series. It features of many widgets, built-in extensible graphics library, intuitive design, C programming, Ladder Diagram supporting, fully I/O integration... etc. Using HMIWorks can help users to short the development time and design the sophisticated, cost effective solutions for the complex systems.

## 1. Support Many Widgets - Shorten Development Time

There are many widgets included in the HMIWorks development tool, including Rectangle, Ellipse, Text, Picture, Line, TextPushButton, Slider, BitButton, HotSpot, CheckBox, Label, Timer, PaintBox, ObjectList, providing the most commonly-used functions, such as drawings, event handlers, and timing control, which effectively shortens development time.

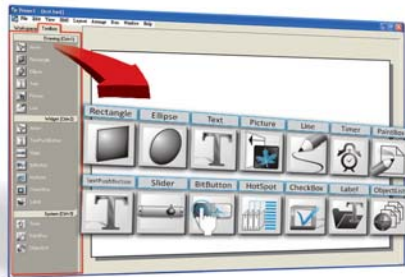

## 2. Built-in the Extensible Graphics Library

HMIWorks supports simple graphics functions and provides users with a variety of built-in graphics for common situations. Users can also add their own graphics to the library by the common painting or photo editing software.

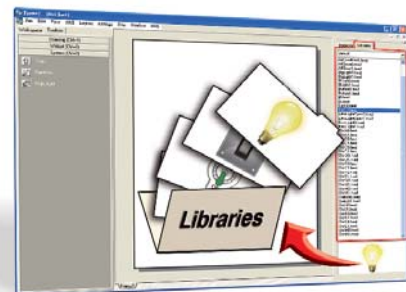

## 3. 65536 Colors - Bright and Clear

Presently, LCD touch screens are available at 2.8", 3.5", 4.3", and 7" includes different resolutions from 240 × 320 × 16 to 800 × 480 × 16. ICP DAS will expand this range in the future.



## 4. Intuitive Design

HMIWorks provides a intuitive graphical design interface that allows users to focus on what they want to do. By getting rid of the programming details and being more intuitive, everyone can easily finish their projects.



## 5. C and Ladder Diagram Programming



## 6. Drag-and-drop Design - fully integrate with I/O (support third party modules)

ICP DAS now supports many I/O devices, such as ET-7000/PET-7000 series Modbus TCP modules, M-7000 series Modbus RTU modules, I-7000 series DCON modules and user-defined third party Modbus TCP devices. Users can expect that additional I/O devices will be supported by HMIWorks in the future.



## Selection Guide:

# TPD -

# XX

**LCD**  
28: 2.8"  
43: 4.3"  
70: 7.0"

# X(X)

**Communication Interface**  
0: 1 × RS-485  
2: 2 × COM ports  
3: Ethernet and COM port  
(U): with extra Flash  
(F): Flat Type

# XX

**EU: For European**  
86 × 86 mm Outlet Box  
H: High Speed Version  
Mx: Multi Panel  
64: 64 MB Extra Flash

Model Name	Extra Flash	Image Storage Capacity	Ethernet	COM port	RTC	Outlet Box	External Wall Box	Power Input
<b>2.8" (Resolution: 240 × 320)</b>    								
TPD-280-H	-	4	-	1 × RS-485	-	OB120	EWB-T28	+12 ~ 48 Vdc
TPD-283-H	-	4	Yes	-	-			PoE
TPD-280U-H	16 MB	108	-	1 × RS-485	Yes			+12 ~ 48 Vdc
TPD-283U-H	16 MB	108	Yes	1 × RS-485				+12 ~ 48 Vdc or PoE
TPD-280-M1/M2/M3	-	4	-	1 × RS-485	-			+12 ~ 48 Vdc
TPD-283-M1/M2/M3	-	4	Yes	-	-			PoE
TPD-283U-M1/M2/M3	16 MB	108	Yes	1 × RS-485	Yes			+12 ~ 48 Vdc or PoE
<b>4.3" (Resolution: 480 × 272)</b>  								
TPD-430-H	16 MB	64	-	1 × RS-485	Yes	OB120	EWB-T43	+12 ~ 48 Vdc
TPD-433-H			Yes					+12 ~ 48 Vdc or PoE
TPD-430-H-EU			-			European 86 × 86 mm	+12 ~ 48 Vdc	
TPD-433-H-EU			Yes				+12 ~ 48 Vdc or PoE	
TPD-432F	8 MB	32	-	2 × RS-485	OB140F OB140FP	EWB-T43F	+10 ~ 30 Vdc	
TPD-433F-H	16 MB	64	Yes	1 × RS-232			+12 ~ 48 Vdc or PoE	
TPD-433-M2				1 × RS-485				
<b>7" (Resolution: 800 × 480)</b> 								
TPD-703	16 MB	18	Yes	1 × RS-232	Yes	OB170	EWB-T70	+12 ~ 48 Vdc or PoE
TPD-703-64	64 MB	84		1 × RS-485				

**Note1:** Image Storage Capacity depends on the content of program and the size of images. The number is counted by how many images in full screen size can be stored on the device.

**Note2:** PoE (Power over Ethernet) specification: IEEE 802.3af, Class 1, 48 V



## External Wall Box and Outlet Box:

**For 2.8" (TPD-280-H/TPD-280U-H/TPD-283-H/TPD-283U-H)**

EWB-T28-BK		EWB-T28 (External Wall Box)		OB120 (Outlet Box)	

**For 4.3" (TPD-430-H, TPD-433-H)**

EWB-T43-BK		EWB-T43 (External Wall Box)		OB120 (Outlet Box)	

**For 4.3" (TPD-432F, TPD-433F-H)**

EWB-T43F (External Wall Box)		OB140F (Outlet Box)	

**OB140FP (Outlet Box)**

		<p><b>For 4.3" (TPD-430-H-EU, TPD-433-H-EU)</b></p> <p>Mounted to European-standard 86 mm x 86 mm outlet box.</p>	
--	--	---	--

**For 7" (TPD-703, TPD-703-64)**

EWB-T70 (External Wall Box)		OB170 (Outlet Box)	

## Appearance:

**TPD-280-M1 Front View**

2.8" TFT LCD with Touch Panel



**TPD-283-M2 Front View**

2.8" TFT LCD with Touch Panel



**TPD-283U-M3 Front View**

2.8" TFT LCD with Touch Panel



**TPD-280-M1 Rear View**



Rotary Switch

**TPD-283-M2 Rear View**



Rotary Switch

**TPD-283U-M3 Rear View**

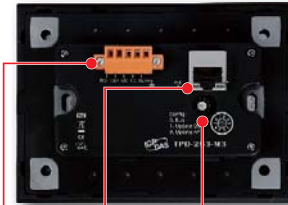

RS-485 Ethernet Rotary Switch

**TPD-280-H Rear View**

RS-485 Rotary Switch



**TPD-280U-H Rear View**

USB RS-485 Rotary Switch



**TPD-283-H Rear View**

Rotary Switch Ethernet

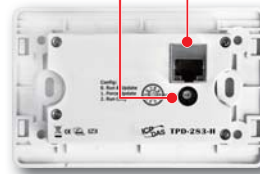

**TPD-283U-H Rear View**

Rotary Switch  
USB RS-485 Ethernet

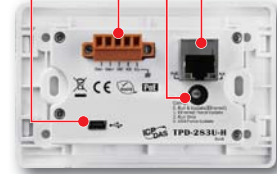

**TPD-430-H Rear View**

Rotary Switch  
RS-485  
USB

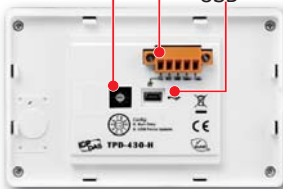

**TPD-433-H Rear View**

Ethernet  
Rotary Switch  
RS-485  
USB

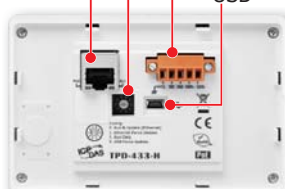

**TPD-430-H-EU Rear View**

Rotary Switch  
RS-485  
USB



**TPD-433-H-EU Rear View**

Rotary Switch  
Ethernet  
RS-485  
USB

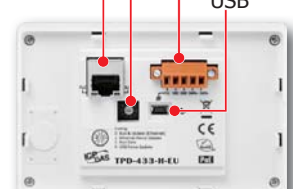

**TPD-280-H/TPD-283(U)-H Front View**

2.8" TFT LCD with Touch Panel



**TPD-430-H(-EU)/TPD-433-H-EU Front View**

LED  
4.3" TFT LCD with Touch Panel  
Speaker



**TPD-433-M2 Front View**

4.3" TFT LCD with Touch Panel



**TPD-433F-H Rear View**

Ethernet RS-485



**TPD-703/TPD-703-64 Front View**

7" TFT LCD with Touch Panel



**TPD-703/TPD-703-64 Front View**

Reset Button  
Rotary Switch



**TPD-703/TPD-703-64 Rear View**

RS-232, RS-485 Ethernet

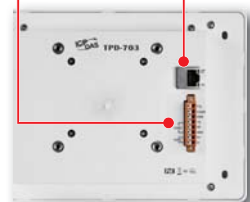

# VPD - 1



**X**

**Touch Screen Size**  
 3: 3.5 inch  
 4: 4.3 inch  
 7: 7 inch

**X(X)**

**Communication Interface**  
 0: RS-485  
 2: RS-232/RS-485 + RS-485  
 3: RS-232/RS-485 + RS-485 + Ethernet  
 (N): No Rubber Keypad

**X**

**H: High Speed Version**  
 64: 64 MB Extra Flash

VPD Model	LCD	Extra Flash	Image Storage Capacity	Com Port	Ethernet	RTC	Expansion I/O Boards	Rubber Keypad	Ingress Protection	Power Input
VPD-130-H	3.5" TFT (Resolution 320 × 240)	16 MB	108	RS-232/RS-485	-	Yes	Yes	Yes	Front Panel: IP65	+12 ~ 48 Vdc
VPD-130N-H								-		
VPD-132-H								Yes		
VPD-132N-H								-		
VPD-133-H								Yes		
VPD-133N-H								-		
VPD-142-H	4.3" TFT (Resolution 480 × 272)	16 MB	64	COM1: RS-485 or RS-232	-	Yes	Yes	Yes	Front Panel: IP65	+12 ~ 48 Vdc
VPD-142N-H								-		
VPD-143-H								Yes		
VPD-143N-H								-		
VPD-173N	7" TFT (Resolution 800 × 480)	16 MB	18	COM1: RS-485 or RS-232 COM2: RS-485 or RS-232	Yes	Yes	-	-	Front Panel: IP65	+12 ~ 48 Vdc or PoE
VPD-173N-64		64 MB	84							
VPD-173X		16 MB	18							
VPD-173X-64		64 MB	84							

**Note1:** Image Storage Capacity depends on the content of program and the size of images. The number is counted by how many images in full screen size can be stored on the device.

**Note2:** PoE (Power over Ethernet) specification: IEEE 802.3af, Class 1, 48 V

## XV-Board

Making VPD series have its own I/O to control!



### Expansion XV-Board Selection Guide:

Model Name	Type	DI			DO		
		Channels	Sink/Source	Contact	Channels	Type	Sink/Source
XV107	DIO	8	Source	Wet	8	Open Collector	Sink/Source
XV107A		8	Sink		8	Open Emitter	Source
XV110		16	Sink/Source	Wet + Dry	-	-	-
XV111		-	-	-	16	Open Collector	Sink
XV111A		-	-	-	16	Open Emitter	Source
XV116		5	Sink/Source	Wet	6	Power Relay, Form A	-

Model Name	Type	AI		AO		DI		DO	
		Channels	Type	Channels	Type	Channels	Type	Channels	Type
XV306	Multi Function	4	Voltage/Current	-	-	4	Wet	4	Relay, FormA, 6A
XV307		-	-	2	Voltage/Current	4	Wet	4	Relay, FormA, 6A
XV308		8	Voltage/Current	-	-	DI+DO=8	Dry/Wet	DI+DO=8	Open Collector, Sink
XV310		4	Voltage/Current	2	Voltage/Current	4	Dry	4	Open Collector, Source



## TPD/VPD Series Applications:

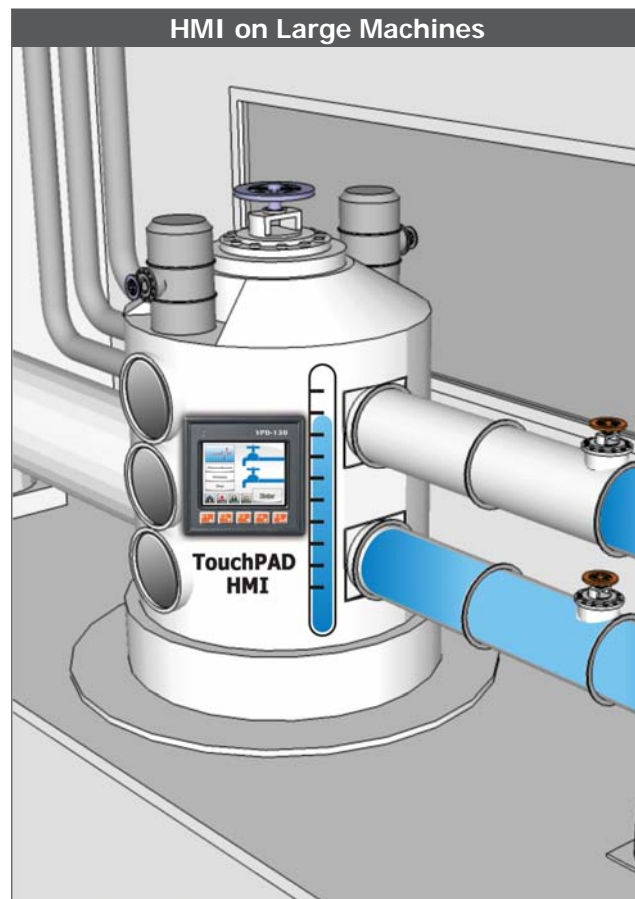
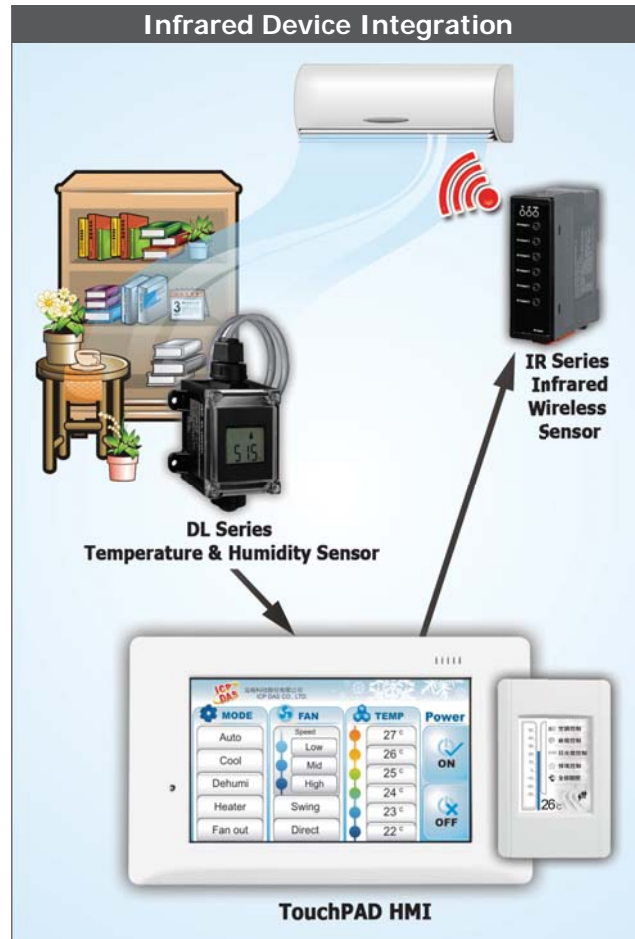
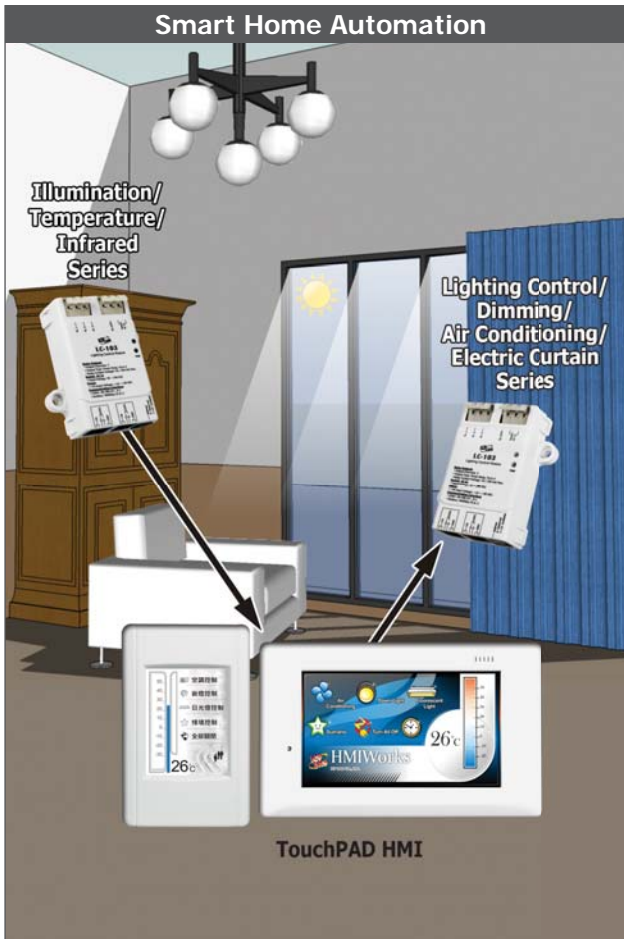

1 PAC Products and BoxPC

2 Panel Products

3 Remote I/O Module and Unit

4 IIoT

# 6. Industrial Modbus LED Display

iKAN-116/iKAN-124



iKAN-216/iKAN-224



## Features:



- Support multiple languages with a text height of 16 or 11.5 cm
- 7 colors: red, blue, yellow, green, light blue, purple and white
- Store up to 128 common messages and 20 instant messages
- Able to convert eight Modbus data sets to ASCII-character messages in real-time
- Integrate both text and variables in a single message
- Supports Modbus TCP/RTU Slave protocols
- Built-in RTC (Real Time Clock )
- Web-based User Interface (HTML5)
- Remotely controlled using a smart phone or mobile device

## Introduction:

The iKAN series is a family of industrial Modbus LED display devices that deliver industrial-grade anti-noise capabilities as well as reliability and stability. ASCII characters and Unicode characters, which can be used to display multiple languages , are supported for presenting formatted messages. Support for the popular Modbus industrial protocol is provided meaning that iKAN display devices can easily integrate into existing PLC and SCADA environments.

The iKAN series allows data written from a PC or a PLC to display on a formatted message in real-time. Seven colors are available for the text, which can be used to indicate different degrees of importance of the message, as well as significantly increase the readability of the message in an industrial arena.

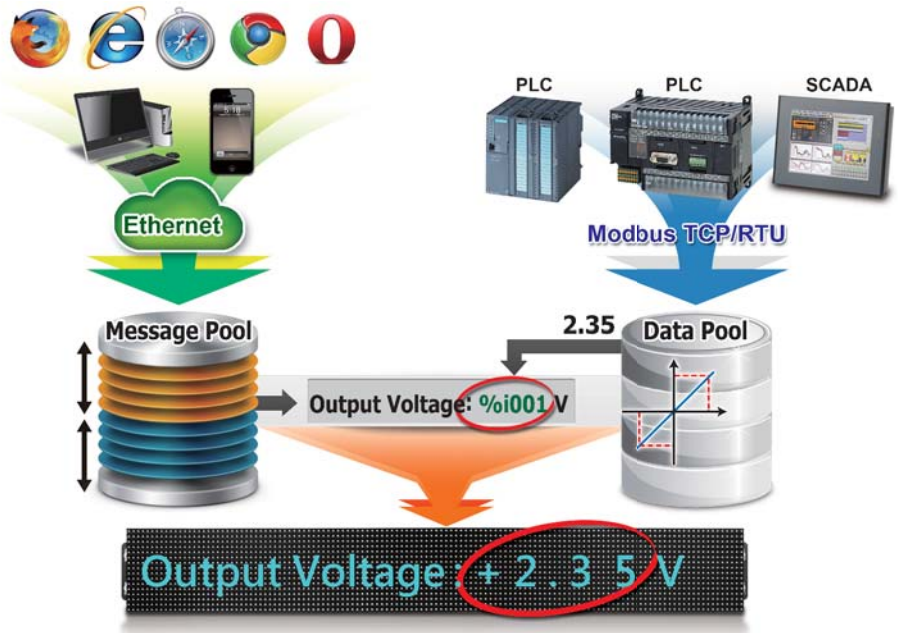

### ■ Built-in RTC

Date and time, 24 hour format including second, minute, hour, date, day of the week, month, year.



### ■ Smart Phone Controllable

Messages can be edited using a standard web browser, such as Google Chrome, Firefox, or IE, etc., on a PC, mobile device, or smartphone without any limitations related to specific control tools or programs.



### ■ Support Modbus TCP/RTU protocols

The popular Modbus industrial protocols are provided. iKAN can be easily integrated into PLC/SCADA.

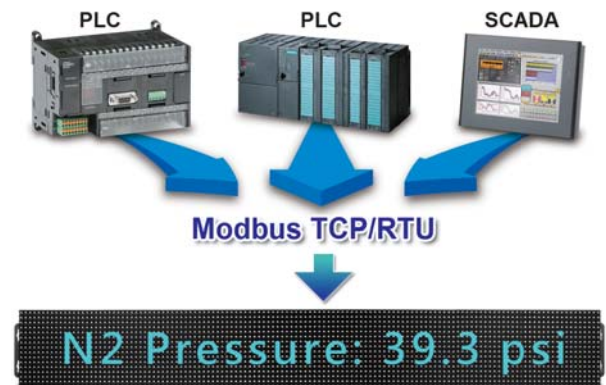



### Indoor Air Quality Display

iKAN can be used to read indoor air quality monitoring data from an external DL-302 module, including the carbon dioxide level, temperature and humidity, and then display the information in real-time, making it suitable for commercial and public buildings, such as schools and museums, as well as for retail, leisure and healthcare facilities.



### Web-based User Interface (HTML5)

A message can be pre-configured, or the variables can be edited, via a standard web browser, meaning that no utility software needs to be installed, and no specific programming knowledge or skills are required.

### Message Editing

The iKAN provides two message editing modes:

- Pre-configured messages:**

Up to 128 common messages and 20 instant messages can be pre-configured from the first moment that the iKAN display is switched on. When the display is in operation, the focus needs only be on message management, rather than the need to frequently update the messages.

- Convert Modbus data to ASCII messages in real time:**

Eight of Modbus holding register sets can be assigned to four real-time messages, with each set containing 32 holding registers that can be used to display up to 64 ASCII characters. A Modbus controller can be used to write data to these registers, and then the iKAN kernel converts the data to ASCII characters to meet more flexible message demands.



### Message Priority

Instant messages have a higher priority than common messages. Once an instant message is enabled, the common message currently being displayed will be suspended until the instant message is disabled. This feature allows the most important information to be displayed in an emergency situation.

## Specifications:

Model	iKAN-116	iKAN-116S	iKAN-124	iKAN-124S	iKAN-216	iKAN-224
<b>Display</b>						
Color	Red, Blue, Yellow, Green, Light Blue, Purple or White					
Character Sets	16-bit Unicode or 7-bit ASCII					
Display	ASCII	1 line × 16 Characters	1 line × 24 Characters	2 line × 16 Characters	2 line × 24 Characters	2 line × 24 Characters
	Unicode	1 line × 8 Characters	1 line × 12 Characters	2 line × 8 Characters	2 line × 12 Characters	2 line × 12 Characters
Message Pool	128 common messages and 20 instant messages					
Data Pool	Up to 20 Unicode characters or 50 ASCII characters each 40 Coil values, 64 Float values, and 64 Integer values					
<b>Communication Interface</b>						
Ethernet	1 × RJ-45, 10/100 Base-TX; Modbus TCP Slave, Max. 8 connections, Web-based User Interface					
COM Port	RS-232 or RS-485, each time select one only (Modbus RTU); Modbus RTU Master Protocol					
PROFIBUS	Baudrate: 9.6 k, 19.2 k, 45.45 k, 93.75 k, 187.5 k, 500 k, 1.5 M, 3 M, 6 M, 12 M; Protocol: DP-V0					
<b>Mechanical</b>						
Dimensions (W × H × D) (mm)	1346 × 160 × 49	834 × 115 × 37.5	1986 × 160 × 49	1218 × 115 × 37.5	1346 × 320 × 49	1986 × 320 × 49
Weight	4 Kg	2 Kg	4.6 Kg	2.5 Kg	6 Kg	12 Kg
Housing Material	Aluminum					
Power Input	100 VAC ~ 240 VAC					



# 7. Touch Monitor

## Introduction:

ICP DAS Touch Monitor series features wide operating temperature and full driver support for Windows 2k/XP/Vista/7/WES, WinCE 5.0/6.0 and Linux. It is guaranteed to work with ICP DAS PAC control system, such as XP-8000 series, WP-8000 series, WP-5000 series and LinPAC series.



Models	TPM-1050	TP-2070	TP-3080	TPM-4100/TP-4100	TP-5120	TP-6150	TP-7170
<b>Display</b>							
Size	5.6"	7"	8.4"	10.4"	12.1"	15"	17"
Resolution	640 × 480	800 × 480	800 × 600			1024 × 768	1280 × 1024
Max. Color	16.7 M						
Luminance	400 cd/m2						350 cd/m2
Touch screen	4 Wire, analog resistive, Light Transmission: 80%		5 Wire, analog resistive, Light Transmission: 80%				
Contrast Ratio	500 : 1						
Viewing Angle (H/V)	140/120		140/130				
Backlight Life (hrs)	20,000		50,000				
Touch Screen Function	Combo RS-232 & USB interface						
Input Signal	VGA (Analog RGB)						
<b>MMI (Man Machine Interface)</b>							
OSD Control	Functions: Power Brightness, Contrast, Phase, Horizontal Position, Vertical Position and Sharpness						
LED Indicators	Power, Display signal is detected						
<b>Power</b>							
Input Range	+12 ~ +48 Vdc						
Power Consumption	5 W	5 W	7 W	8.5 W	12 W	14.4 W	22 W
<b>Mechanical</b>							
Material	Aluminum	Plastic	Plastic	Aluminum/Plastic	Plastic	Plastic	Plastic
Dimensions (W × L × H)	186 × 148 × 44 mm	213 × 148 × 44 mm	249 × 207 × 65 mm	293 × 231 × 53 mm 291 × 229 × 54 mm	323 × 254 × 65 mm	381 × 305 × 65 mm	413 × 359 × 70 mm
Installation	Panel Mounting, VESA Mounting (75 × 75 mm)		Panel Mounting, VESA Mounting (75 × 75 mm; 100 × 100 mm)	Panel Mounting/ Panel Mounting, VESA Mounting (75 × 75 mm)	Panel Mounting, VESA Mounting (75 × 75 mm; 100 × 100 mm)		
Ingress Protection	Front panel: IP65						
<b>Environmental</b>							
Operating Temperature	-20 ~ +70°C						
Storage Temperature	-30 ~ +80°C						
Ambient Relative Humidity	10 ~ 90% RH (non-condensing)						

## Appearance:

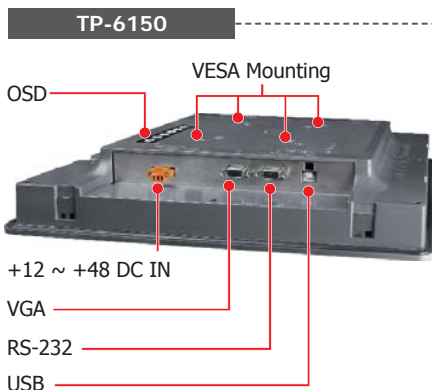

## Ordering Information:

Model No.	Description	Model No.	Description
TPM-1050	5.6" Touch Monitor with power supply	TPM-1050/NP	TPM-1050 w/o power supply
TP-2070	7" Touch Monitor with power supply	TP-2070/NP	TP-2070 w/o power supply
TP-3080	8.4" Touch Monitor with power supply	TP-3080/NP	TP-3080 w/o power supply
TP-4100	10.4" Touch Monitor with power supply	TP-4100/NP	TP-4100 w/o power supply
TPM-4100	TP-4100 with Aluminum Casing	TPM-4100/NP	TPM-4100 w/o power supply
TP-5120	12.1" Touch Monitor with power supply	TP-5120/NP	TP-5120 w/o power supply
TP-6150	15" Touch Monitor with power supply	TP-6150/NP	TP-6150 w/o power supply
TP-7170	17" Touch Monitor with power supply	TP-7170/NP	TP-7170 w/o power supply

## Standard Accessories:

VGA cable, RS-232 cable, USB cable, Mounting clamps and screws

# Remote I/O Module and Unit

# 3

## Overview

P 3-1

### 1

## RS-485 I/O Products

P 3-2

- 1.1 I-7000 and M-7000 Series - - - - - P 3-3
- 1.2 RS-485 I/O Expansion Unit - - - - - P 3-14
- 1.3 M-2000 Series I/O Modules - - - - - P 3-15
- 1.4 M-6000 Series I/O Modules - - - - - P 3-16
- 1.5 tM Series Modules - - - - - P 3-17
- 1.6 LC/SC/DALI Series: Smart Lighting Control - - - - - P 3-18

### 2

## Ethernet I/O Products

P 3-23

- 2.1 Ethernet Modbus TCP I/O Modules - - - - - P 3-24
- 2.2 High Speed Data Logger – ET-7H16 - - - - - P 3-30
- 2.3 Tiny-Size Modbus TCP I/O Modules - - - - - P 3-31
- 2.4 Slim-Type Modbus TCP I/O Modules - - - - - P 3-35
- 2.5 EtherNet/IP I/O Modules- - - - - P 3-36
- 2.6 EtherCAT Products- - - - - P 3-37
- 2.7 BACnet/IP I/O Modules- - - - - P 3-38
- 2.8 PROFINET Products- - - - - P 3-39

### 3

## PROFIBUS I/O Products

P 3-41

- 3.1 PROFIBUS Remote I/O Modules - - - - - P 3-42
- 3.2 PROFIBUS Remote I/O Units - - - - - P 3-43

### 4

## CAN Bus I/O Products

P 3-44

- 4.1 CAN Bus I/O Module - - - - - P 3-44
- 4.2 CAN Bus I/O Unit - - - - - P 3-45

### 5

## USB I/O Modules

P 3-46



# Overview

ICPDAS launches a series of remote I/O modules and I/O expansion units for industrial monitoring and controlling applications, various communication interfaces are available for PAC, PC and PLC, such as RS-485, Ethernet, EtherCAT, EtherNet/IP, Profinet, FRnet, CAN bus, Profibus and Hart.



More than 300 modules for choice

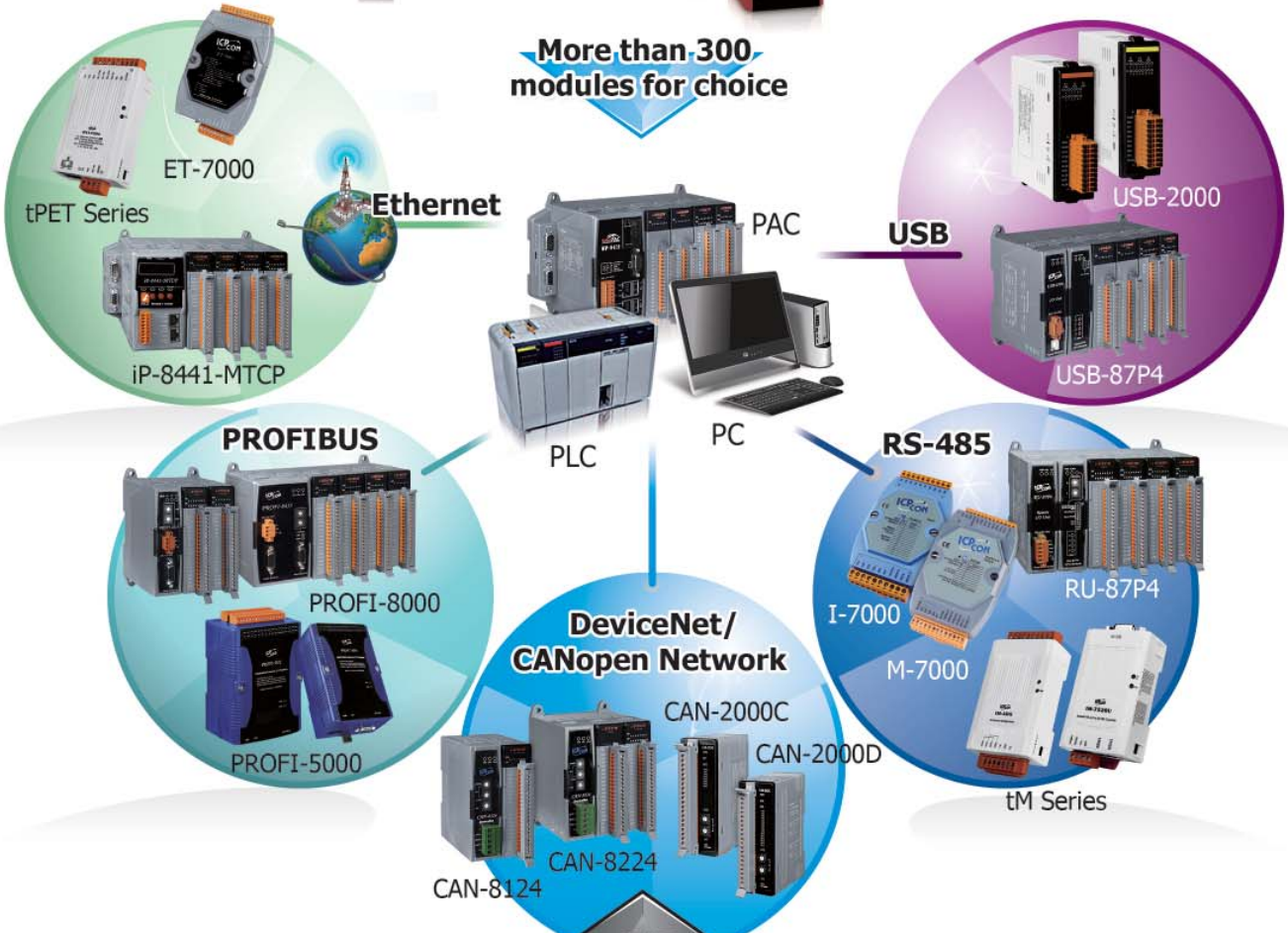







# 1. RS-485 I/O Products

Our RS-485 remote I/O module supports DCON protocol, Modbus RTU/ASCII protocol. According to the different applications, we have developed various RS-485 I/O modules. The module has diversified I/O interface, such as overvoltage-protection analog input module, relay output, digital input/output, counter, timer...etc.

We also provide different ODM modules.

Model Name	tM series	I-7000	M-7000	M-2000	M-6000
Pictures					
<b>Communication</b>					
Protocol	DCON, Modbus RTU, Modbus ASCII	DCON	DCON, Modbus RTU		
Data Format	(N, 8, 1), (N, 8, 2), (O, 8, 1), (E, 8, 1)	(N,8,1)		(N, 8, 1), (N, 8, 2), (O, 8, 1), (E, 8, 1)	
Max. Nodes	32	256			
Bias resistor	Yes, 10 K $\Omega$	No (Note1)			
Dual Watchdog	Yes, Module (2.3 second), Communication (Programmable)	Yes, Module (1.6 second), Communication (Programmable)			
<b>I/O</b>					
DIO max. channel	8	16	16	32	
AIO	Resolution	12/14 bits	12/16 bits		
	Max. channel	8 (tM-AD8)	20 (I-7017Z, M-7017Z)	16	32
	Individual Channel Configuration	-	Yes		
<b>Display</b>					
Power and Communication LED	Yes				
I/O Status LED	-	Yes (for D version only)	-	Yes	
7-Segment LED	-	Yes (for D version only)	-	-	
<b>Mechanical</b>					
Dimensions (W × L × D)	52 × 98 × 27 mm	72 × 123 × 35 mm	110 × 33 × 96 mm 140 × 31 × 113 mm	240 × 135 × 65 mm 116 × 120 × 65 mm	
<b>Note1:</b> The RS-485 master is required to provide the bias. Otherwise, the tM-SG4 or SG-785 should be added to provide the bias. All ICP DAS controllers and converters provide the bias.					

Furthermore, we also developed RU-87Pn, a series of RS-485 remote I/O unit for compact and modular I/O expansion. Reliable 3-piece construction enables users to hot swap modules during operation, without rewiring. All I/O module data are backed up in the non-volatile memory of the RU-87Pn. After hot-swapping a module, all settings are automatically loaded to recover.



## Features:

- Hot Swap
- Auto Configuration
- Easy Duplicate System
- Easy Maintenance and Diagnosis
- DCON Protocol

# 1.1 I-7000 and M-7000 Series

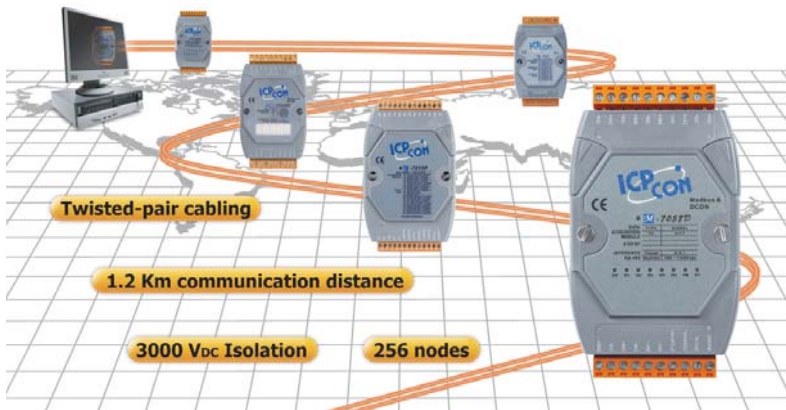

The product line includes sensor-to-computer, computer-to-sensor, digital I/O, timer/ counter, RS-232 to RS-485 converter, USB to RS-485 converter, RS-485 repeater, RS-485 hub and RS-232/422/485 to Fiber Optics. I-7000 supports DCON protocol, and M-7000 modules support Modbus RTU and DCON protocols.

## Applications:

Solar energy system, Internet of Things, Industrial 4.0 .

## Features:

### ■ RS-485 Industrial Multi-Drop Network

I-7000/M-7000 series modules use the industrial EIA RS-485 communication interface to transmit and receive data at high speed over long distance.

### ■ I/O type and Range Programmable

The analog modules support several types and ranges which can be selected remotely by issuing command from the host.

### ■ Easy Mounting and Connection

### ■ Dual Watchdog Design

The module watchdog is a hardware watchdog designed to automatically reset the micro-processor when the module hangs. The host watchdog is a software watchdog that monitors the communication status of the host controller, such as PC, PLC and PAC. The output of module will go to the safe value state when the host fails to prevent any erroneous operations. The Dual Watchdog design ensures higher reliability and stability.

### ● Programmable Power-on Value and Safe Value

The DO and AO I/O modules provide programmable power-on value and safe value. When the host watchdog is active, the DO and AO output go to the pre-configured safe value.

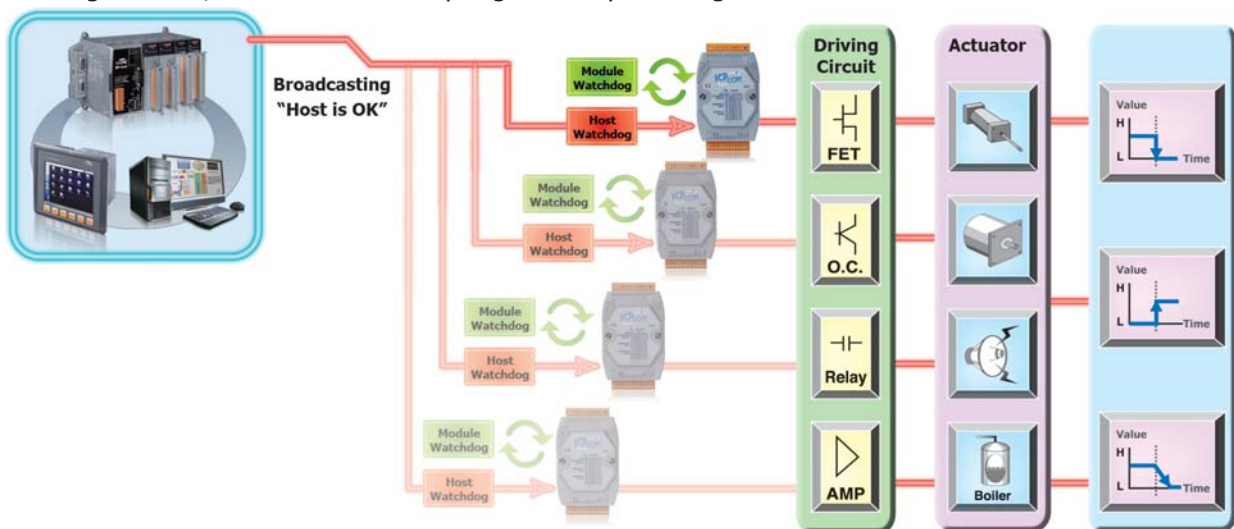

### Advanced DI Functions

DI channel is not only for reading digital input status but also provides several advanced functions in the meanwhile.

#### DI latch Function

All DI channels provide Latch function to keep the high/low events in the internal registers of the module.

In general, the host controller gets all DI status through polls modules separately. With the DI latch function, no longer lose short duration ( $\geq 5$  ms) signals anymore.

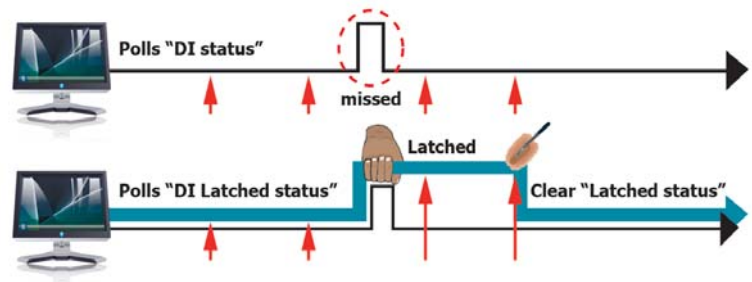

#### Low Speed Counter

The DI module automatically counts the DI signal in the background. The signal under 100 Hz can be detected and counted.



### Overvoltage Protection

Many of our analog input modules provide high overvoltage protection for the analog input channels. This feature improves the reliability, reduces maintenance frequency, and makes the whole system more robust.

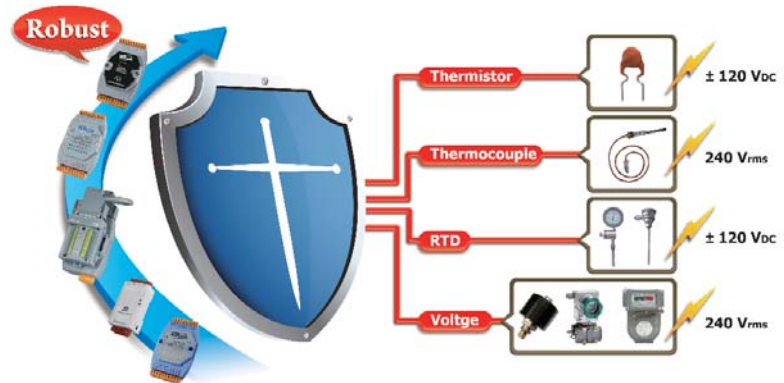

### Open Wire Detection

The thermocouple, RTD and thermistor sensors are widely used in temperature control applications. If the system cannot monitor the open wire status of the sensors, it may be very dangerous and cause large damage to life and property. When the wire of sensor is broken and the controller does not know the open wire status, the system may heat the boiler continuously and result in fire or explosion. Our thermocouple, RTD, thermistor modules provide open wire detection and make the system safer.

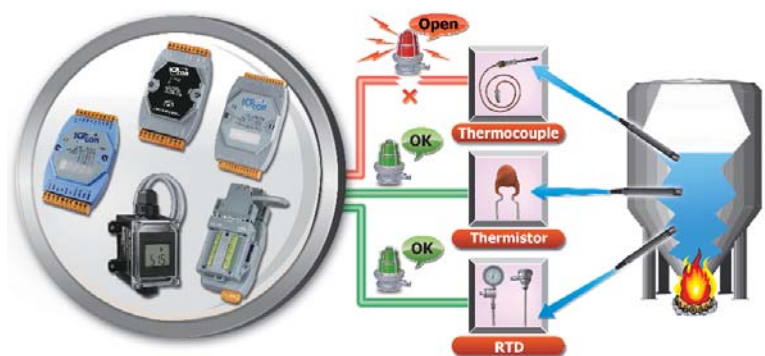

### Over-current Protection

For the current measurement module, it may be damaged when there is high current or voltage introduced into the current loop. The protection for current measurement is improved to  $\pm 120$  VDC and  $\pm 1000$  mA.

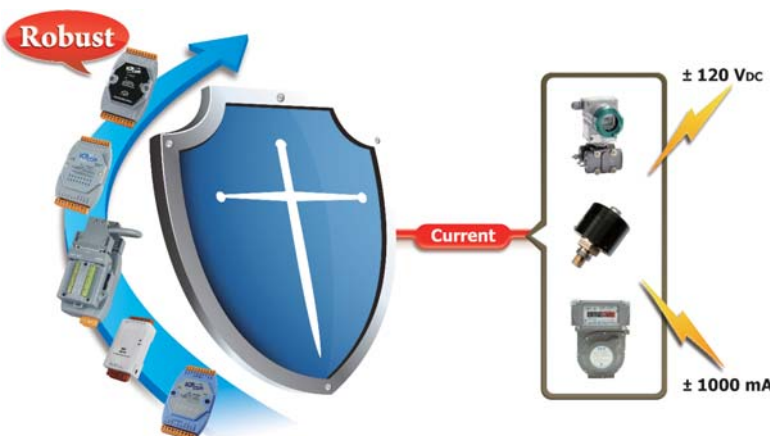



### Virtual Channel to Channel Isolation

The "R" and "Z" version of analog input modules provide  $\pm 400$  VDC virtual channel to channel isolation to avoid the noise interference from adjacent channel in the industrial environment. To name a few of the modules, they are I-7017R, I-7017Z, I-7018R, I-7018Z, I-7019R, and I-7019Z.

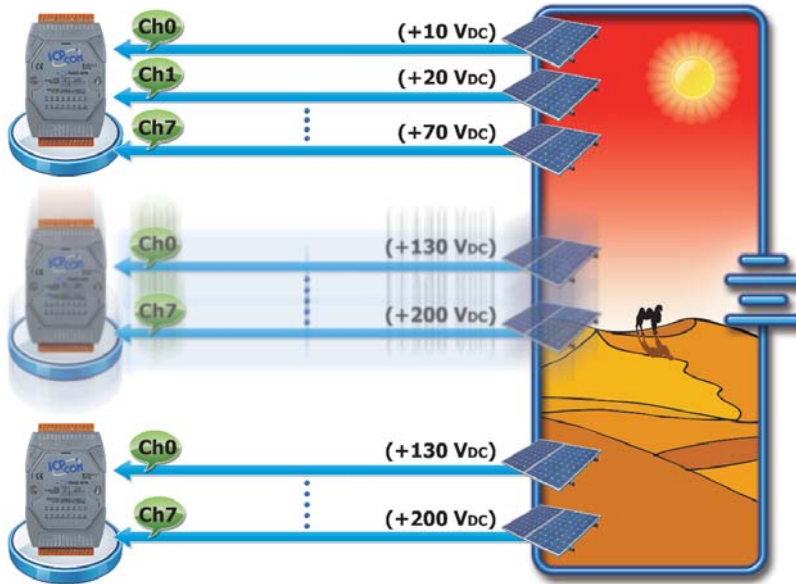
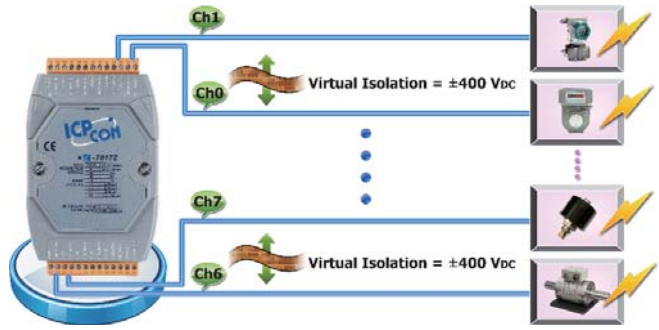

### Common Voltage Protection

The typical application is to monitor the charging status of the batteries in series. The voltage of each battery is +10 VDC so the first battery is +10 VDC, the second battery is +20 VDC etc. The differential voltage of the 20th battery is only +10 VDC between  $v_{in+}$  and  $v_{in-}$  terminal, while the common voltage is up to 200 VDC. If the common voltage of the analog input module is not large enough, then it cannot measure the correct voltage of the battery in charging.

### ESD Protection

The I-7K and M-7K modules all pass  $\pm 4$  KV ESD contact and  $\pm 8$  KV ESD air tests by static electricity gun in our laboratory. The test procedures follow the IEC 61000-4-2 standard. Our modules are immunity to the electrostatic discharges by using components that can clamp and resist to the high voltages defined by IEC 61000-4-2 standard.

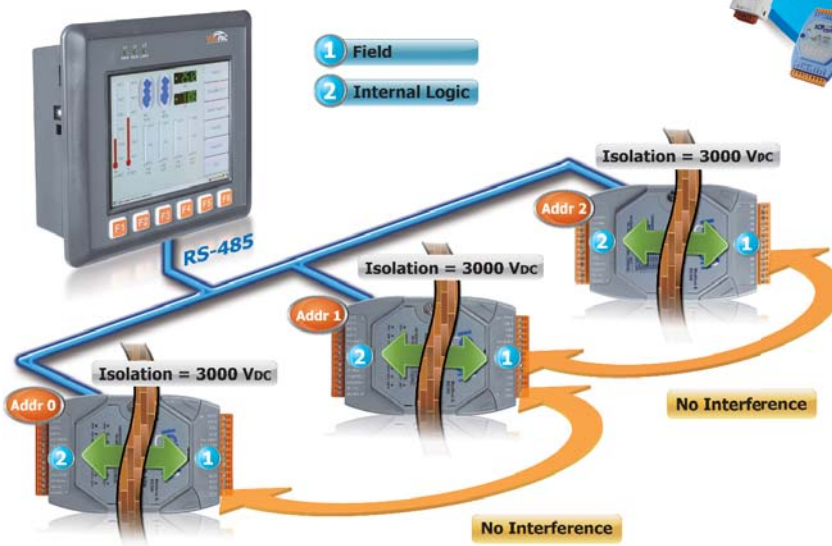

### 3000 VDC Isolation

The I-7K and M-7K series have 3000 VDC isolation between the field and the internal logic. This isolation prevents the noise from the field to the internal logic that can damage the module.

## Dual Communication Protocols

All I-7000 and M-7000 modules use a simple command /response protocol for communication. M-7000 also supports the industrial standard Modbus RTU protocol. The user can use high-level language, such as C, VB, Delphi, and others to write their application programs. Some famous software package can control I-7000 and M-7000 directly, such as LabVIEW, InduSoft, TRACE MODE, EZ data logger, EZ Prog..etc.

**I-7000:** supports DCON protocol

**M-7000:** supports Modbus RTU and DCON protocols

## Self-Tuner Inside



"Self-Tuner" is a patented ASIC. It auto-tunes the baud rate and data format in whole RS-485 network, and auto-handles the direction of the RS-485 communication line. Since the unique features of this ASIC, the user can implement a very flexible remote I/O configuration via the RS-485 network.

## Expandable Network

"Self-Tuner" ASIC is built-in. It has some outstanding features, such as 3000V isolation, 115K max. speed, variable baud rate and data format. Each I-7510 repeater can let you extend the network to another 4,000 ft long.

## Hardware:

### 1. Installation



DIN-Rail Mounting



Stack Mounting

### 2. Dimensions (Units: mm)

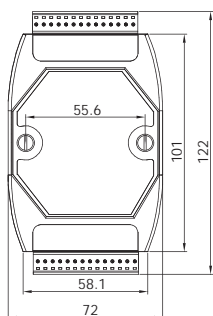

Front View

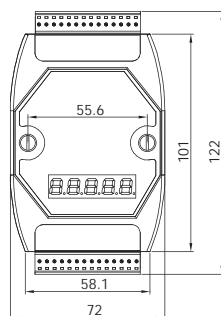

Front View

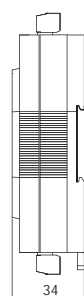

Left View

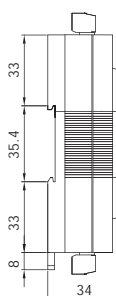

Right View

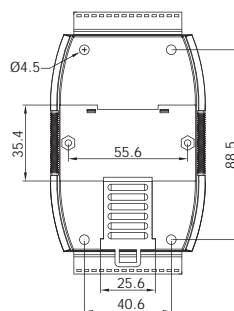

Rear View

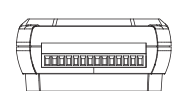

Top View

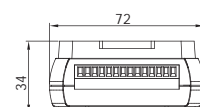

Bottom View

## Software Support:

Our free charge software utility and development kit include

### 1. DCON Utility

DCON Utility is used to search, configure and test simply the I-7000 and M-7000 modules via the serial port (RS-232/485).

### 2. OPC Server

**NAPOPC\_ST DA Server** is a **free** OPC DA Server ("OPC" stands for "OLE for Process Control" and "DA" stands for "Data Access") for ICP DAS products. Based on Microsoft's OLE COM (component object model) and DCOM (distributed component object model) technologies, NAPOPC\_ST DA Server defines a standard set of objects, interfaces and methods for use in process control and manufacturing automation applications to facilitate the interoperability.

Using NAPOPC\_ST DA Server, system integrates data with SCADA/HMI/Database software on the same computer and others. SCADA/HMI/Database sends a request and NAPOPC DA Server fulfills the request by gathering the data of ICP DAS modules (**License Free**) and third-party devices (**License Charge**) to SCADA/HMI/Database.

For different OS of PAC products, ICP DAS provides several professional DA Servers:

Version	NAPOPC_ST	NAPOPC_XPE	NAPOPC_CE5	NAPOPC_CE6
Platform	Desktop Windows	Windows XP Embedded	Windows CE5	Windows CE6
Price	Free/	Free	Free	Free

For more Information please visit <http://opc.icpdas.com>

### 3. EZ Data Logger

EZ Data Logger is the software that ICP DAS provides for users to easily build a small SCADA system on Windows 2000/XP/Vista. It comes with two versions, "Lite" & "Professional". The Lite version is not only full-functioned but free to all ICP DAS users!

EZ Data Logger is a small data logger software. It can be applied to small remote I/O system. With its user-friendly interface, users can quickly and easily build a data logger software without any programming skill.

**EZ Data Logger**  
 DCON  
 Modbus TCP  
 Modbus Serial

- ★Virtual Channel Definition
- ★Control Logic (VB Script)
- ★Alarm Notifier
- ★IP Camera Viewer
- High/Low Alarm
- Data Trend
- Layout
- Database and Report

### 4. Various Software Development Toolkits

Plenty of library functions and demo programs are provided to let user develop programs easily under Windows, Linux and DOS operating systems. We also provide LabVIEW driver, DASyLab driver and InduSoft driver for all I-7000 and M-7000 modules. The SDK includes:

DLL, ActiveX, LabVIEW driver, InduSoft driver, DASyLab driver, Linux driver

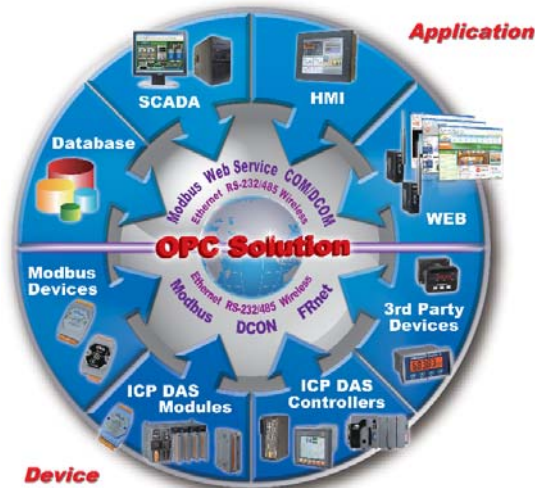
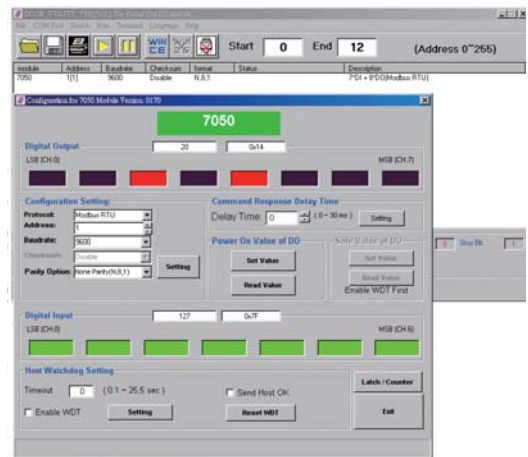



## Selection Guide:



Voltage & Current Input



Model Name		Analog Input							Note
		Channels	Resolution	Sampling Rate (total)	Voltage and Current Input	Common Voltage Protection	Individual Channel Configurable	Oversvoltage Protection	
<b>I-7012</b> <b>I-7012D</b>		1 diff.	16-bit	10 Hz	±150 mV, ±500 mV, ±1 V, ±5 V, ±10 V, ±20 mA (Note1)	±100 VDC		±100 VDC	DI × 1 (Note3) DO × 2 (Note4)
<b>I-7012F</b> <b>I-7012FD</b>				10/100 Hz	±150 mV, ±500 mV, ±1 V, ±5 V, ±10 V, ±20 mA (Note1)				
<b>I-7017</b>	<b>M-7017</b>	8 diff.	16-bit	10 Hz	±150 mV, ±500 mV, ±1 V, ±5 V, ±10 V, ±20 mA (Note1)	±35 VDC	-	±120 VDC	
<b>I-7017C</b>	<b>M-7017C</b>				0 ~ 20 mA, 4 ~ 20 mA, ±20 mA (Note2)			±100 VDC	
<b>I-7017F</b>				10/60 Hz	±150 mV, ±500 mV, ±1V, ±5 V, ±10 V, ±20 mA (Note1)	±200 VDC	Yes (Note6)	±120 VDC	±240 Vrms
<b>I-7017FC</b>					0 ~ 20 mA, 4 ~ 20 mA, ±20 mA (Note2)			±100 VDC	
<b>I-7017R</b>	<b>M-7017R</b>			10/50 Hz	±50 V, ±150 V,	±200 VDC	-	200 VDC	
<b>I-7017R-A5</b>	<b>M-7017R-A5</b>			10/60 Hz	0 ~ 20 mA, 4 ~ 20 mA, ±20 mA (Note2)			±100 VDC	
	<b>M-7017RMS</b>			10 Hz	0 ~ +10 Vrms, 0 ~ +5 Vrms, 0 ~ 1 Vrms, 0 ~ 500 mVrms, 0 ~ 150 mVrms	±200 VDC	-	±35 VDC	
<b>I-7017Z</b>	<b>M-7017Z</b>			10 diff. or 20 SE	±150 mV, ±500 mV, ±1 V, ±5 V, ±10 V, 0 ~ 20 mA, 4 ~ 20 mA ±20 mA (Note5)			±200 VDC	
	<b>M-7017mc-16</b>			16 diff/ SE	10/200 Hz	0 ~ 20 mA, 4 ~ 20 mA ±20 mA	±100 VDC		100,000 records for 16 AI Data Logger

Note1: Need external 125 Ω resistors.

Note2: Doesn't need external 125 Ω resistors.

Note3: Can be used as DI or low speed (50 Hz) counter.

Note4: Can be used as DO or High/Low Alarm.

Note5: Jumper selectable.

Note6: Only available with the firmware version of 7017R series is B3.9 and later.

Thermocouple Input



Model Name		Analog Input							Note	
		Channels	Resolution	Sampling Rate (total)	Voltage and Current Input	Sensor Input	Open Wire Detection	Individual Channel Configurable		Overvoltage Protection
<b>I-7011</b> <b>I-7011D</b>		1 diff.			±15 mV, ±50 mV, ±100 mV, ±500 mV, ±1 V, ±2.5 V, ±20 mA (Note1)	J.K.T.E. R. S. B. N.C Thermocouple	Yes		±5 VDC	DI × 1 (Note2) DO × 2 (Note3)
<b>I-7011P</b> <b>I-7011PD</b>					±15 mV, ±50 mV, ±100 mV, ±500 mV, ±1 V, ±2.5 V, ±20 mA (Note1)	J.K.T.E.R.S. B.N.C.L.M Thermocouple				
	<b>M-7018-16</b>	16 diff.			±15 mV, ±50 mV, ±100 mV, ±50 0mV, ±1 V, ±2.5 V, ±20 mA (Note1)	J.K.T.E. R. S.B.N.C Thermocouple			±120 VDC	
<b>I-7018</b>	<b>M-7018</b>	8 diff.	16-bit	10 Hz	±15 mV, ±50 mV, ±100 mV, ±500 mV, ±1 V, ±2.5 V, ±20 mA (Note1)	J.K.T.E.R.S. B.N.C.L.M Thermocouple	-		±120 VDC	
<b>I-7018P</b>										
<b>I-7018BL</b>										
<b>I-7018R</b>	<b>M-7018R</b>									
<b>I-7018Z</b>	<b>M-7018Z</b>	10 diff.			±50 mV, ±100 mV, ±500 mV, ±1 V, ±2.5 V, ±20 mA (Note1)	J.K.T.E.R.S. B.N.C.L.M, LDIN43710 Thermocouple	Yes			
<b>I-7019R</b>	<b>M-7019R</b>	8 diff.			±15 mV, ±50 mV, ±100 mV, ±150 mV, ±500 mV, ±1 V, ±2.5 V, ±5 V, ±10 V, ±20 mA (Note4)	J.K.T.E.R.S. B.N.C.L.M, LDIN43710 Thermocouple		Yes	±240 Vrms	
	<b>M-7019Z</b>	10 diff.								

- Note1:** Need external 125 Ω resistors.
- Note2:** Can be used as DI or low speed (50 Hz) counter.
- Note3:** Can be used as DO or Alarm.
- Note4:** Jumper selectable.



### RTD Input



Model Name		Analog Input							
		Channels	Resolution	Sampling Rate (total)	Sensor Input	Open Wire Detection	Individual Channel Configurable	3 Wire RTD long distance measurement	Oversvoltage Protection
<b>I-7013</b>		1	16-bit	10 Hz	Pt100, Pt1000, Ni120	Yes	-	Yes	±5 V
	<b>M-7013P</b>	1 (Note1)		10 Hz	Pt100				±30 V
<b>I-7015</b>	<b>M-7015</b>	6 diff.		12 Hz	Pt100, Pt1000, Ni120, Cu100, CU1000				±110 V
<b>I-7015P</b>	<b>M-7015P</b>			12 Hz	Pt100, Pt1000, Ni120, Cu100, CU1000				
<b>I-7033</b>	<b>M-7033</b>	3 diff.		15 Hz	Pt100, Pt1000, Ni120				-
<b>I-7033D</b>	<b>M-7033D</b>								

**Note1:** M-7013P also includes 1 × DI (Dry contact, Source), 2 × DO (Open Collector, MOSFET, Sink, 700mA)



### DS18B20 Sensor



Model Name		Analog Input							
		Ports	Resolution	Sampling Rate	Sensor Input	Temperature Measurement Range	Open Wire Detection	Sensor Wiring Length	Number of Sensors
	<b>M-7004</b>	4	12-bit	1 Hz	DS18B20	-55°C to +125°C	-	300 m per Ports	20 per Ports



### Thermistor Input



Model Name		Analog Input							Digital I/O
		Channels	Resolution	Sampling Rate	Sensor Input	Open Wire Detection	Individual Channel Configurable	Oversvoltage Protection	
<b>I-7005</b>	<b>M-7005</b>	8 diff.	16-bit	8 Hz	Precon ST-A3, Fenwell U, YSI L100, YSI L300, YSI L1000, YSI B2252, YSI B3000, YSI B5000, YSI B6000, YSI B10000, YSI H10000, YSI H30000, User-defined	Yes	Yes	±110 V	DO × 6 (Note1)

**Note1:** Can be used as DO or High/Low Alarm.



### Transmitter Input



Model Name		Analog Input							Digital I/O	
		Channels	Resolution	Sampling Rate	Voltage and Current Input	Input Linear Scaling	Open Wire Detection	Individual Channel Configurable		Oversvoltage Protection
<b>I-7014D</b>		1 diff.	16-bit	10 Hz	±150 mV, ±500 mV, ±1 V, ±5 V, ±10 V, ±20 mA (Note1)	Yes	-	-	±15 V	DI × 1 (Note2) DO × 2 (Note3)

**Note1:** Need external 125 Ω resistors.  
**Note2:** Can be used as DI or low speed (100 Hz) counter.  
**Note3:** Can be used as DO or High/Low Alarm.



### Strain Gauge



Model Name		Analog Input							Digital I/O
		Resolution	Channels	Sampling Rate	Voltage and Current Input	Sensor Input	Input Linear Scaling	Oversvoltage Protection	
<b>I-7016</b>	<b>M-7016</b>	16-bit	2 diff.	10 Hz for 1-channel mode, 2 Hz for 2-channel mode	±15 mV, ±50 mV, ±100 mV, ±500 mV, ±1 V, ±2.5 V, ±20 mA	4 Wire Strain Gauge	Yes	±5 V	DI × 1 (Note1) DO × 4 (Note2)
<b>I-7016P</b>	<b>M-7016PD</b>					6 Wire Strain Gauge			

**Note1:** Can be used as DI or low speed (50 Hz) counter.  
**Note2:** Can be used as DO or Alarm.



Analog Output



Model Name		Analog Output					
		Resolution	Channels	Voltage Output	Current Output	Safe Value	Power-on Value
I-7021		12-bit	1	0 ~ 10 V	0 ~ 20 mA 4 ~ 20 mA	Yes	Yes
I-7021P		16-bit					
I-7022	M-7022	12-bit	2 (Note1)	±10 V, 0 ~ 10 V, ±5 V, 0 ~ 5 V	0 ~ 20 mA 4 ~ 20 mA	Yes	Yes
I-7024	M-7024	14-bit	4				
	M-7024R		4 (Note2)				
	M-7024U M-7024UD (Note3)	16-bit	4 (Note4)				
	M-7028	12-bit	8				

Note1: Channel-to-channel isolation.  
 Note2: M-7024R also includes 5 channel DI (Dry Contact).  
 Note3: M-7024UD includes LED for DI and DO status.  
 Note4: M-7024U and M-7024UD also include 4 × DI(Dry and Wet contact)

Multi-function



Model Name	Analog Input		Analog Output		DC Input		DC Output	
	Channels	Voltage and Current Input	Channels	Voltage and Current Output	Channels	ON Voltage Level	Output type	Max Load Current
M-7002	4	±150 mV, ±500 mV, ±1 V, ±5 V, ±10 V, 0 ~ 20 mA, 4 ~ 20 mA, ±20 mA (Note1)	-	-	5	10 ~ 50 VDC	Power Relay (Form A)	5 A @ 250 VAC/ 30 VDC
M-7003	8		-	-	-	-		
M-7026	6		2	±10 V, 0 ~ 10 V, ±5 V, 0 ~ 5 V, 0 ~ 20 mA, 4 ~ 20 mA (Note1)	3	Connect to GND	Open Collector × 3	Sink, 700 mA

Note1: Jumper selectable.

DC Input



Model Name		DC Input				
		Channels (Note1)	Type	ON Voltage Level	OFF Voltage Level	Isolation Voltage
I-7041 I-7041D	M-7041 M-7041D	14 (Sink/Source)	Common Source	+4 ~ +30 V	+1 V Max.	3750 Vrms
I-7041P I-7041PD	M-7041P M-7041PD			+19 VDC ~ +30 VDC	+11 VDC Max.	
	M-7041-A5 M-7041D-A5			+68 VDC ~ +150 VDC	+11 VDC Max.	
I-7051 I-7051D	M-7051 M-7051D	16 (Sink/Source)	Common Source or Common Ground	+10 ~ +50 V	+4 V Max.	5000 Vrms
I-7052 I-7052D	M-7052 M-7052D	8 (Sink/Source)	6 Differential and 2 Common Ground (Note2)	+4 ~ +30 V	+1 V Max.	
I-7053_FG I-7053D_FG	M-7053 M-7053D	16 (Sink/Source)	Dry Contact	Open		

Note1: DI channel can be used as DI or low speed (100Hz) counter.  
 Note2: 6 differential inputs provide 2 KV channel to channel isolation.

DC Output



Model Name		DC Output					
		Channels	Output type	Load Voltage	Max Load Current	Short Circuit Protection	Isolation Voltage
I-7042 I-7042D		13 (Sink)	Open Collector (NPN)	+3.5 ~ +30 V	100 mA	-	3750 Vrms
I-7043 I-7043D		16 (Sink)					-
I-7045 I-7045D	M-7045 M-7045D	16 (Source)	Open Source (N-MOSFET)	+10 ~ +40 V	650 mA	Yes	3750 Vrms
I-7045-NPN I-7045D-NPN	M-7045-NPN M-7045D-NPN	16 (Sink)	Open Collector (NPN)	+3.5 ~ +50 V	700 mA		3750 VDC
	M-7045U M-7045UD	16 (Sink/Source)	NPN/PNP Bi-direction	+3.5 ~ +80 V	500 mA	-	2000 VDC

## ✓ DC Input/Output



Model Name		DC Output				DC Input		
		Channels	Load Voltage	Max Load Current	Short Circuit Protection	Channels (Note1)	ON Voltage Level	OFF Voltage Level
<b>I-7044</b> <b>I-7044D</b>		8 (Sink) Open Collector (3750 Vrms)	+3.5 ~ +30 V	375 mA	-	4 (Sink/Source, 3750 Vrms)	+4 ~ +30 V	+1 V Max.
<b>I-7050</b> <b>I-7050D</b>	<b>M-7050</b> <b>M-7050D</b>	8 (Sink) Open Collector (3750 Vrms)		30 mA		7 (Sink, Non-Isolation)		
<b>I-7050A</b> <b>I-7050AD</b>		8 (Source) Open Collector (3750 Vrms)		50 mA		7 (Source, Non-Isolation)		
<b>I-7055</b> <b>I-7055D</b>	<b>M-7055</b> <b>M-7055D</b>	8 (Source) Open Source (3750 Vrms)	+10 ~ +40 V	650 mA	Yes	8 (Sink/Source, 3750 Vrms)	+10 ~ +50 V	+4 V Max.
<b>I-7055-NPN</b> <b>I-7055D-NPN</b>	<b>M-7055-NPN</b> <b>M-7055D-NPN</b>	8 (Sink) Open Collector (NPN) (3750 Vrms)	+3.5 ~ +50 V	700 mA		8 (Sink/Source, 3750 Vrms)		
	<b>M-7055U</b> <b>M-7055UD</b>	8 (Sink/Source) (2000 VDC)	+3.5 ~ +80 V	500 mA		8 (Sink/Source, 3750 Vrms)		

**Note1:** DI channel can be used as DI or low speed (100 Hz) counter.

## ✓ DC Universal Digital Input/Output



Model Name		DI + DO	DO				DI	
		Channel	Type	Load Voltage	Max. Load Current	Short Circuit Protection	Type	Sink/Source
<b>M-7054</b> <b>M-7054D</b>	16	Sink Open Collector	+ 3.5 ~ + 30 VDC	100 mA/channe	-	Dry	Source	
<b>M-7054P</b> <b>M-7054PD</b>			+ 3.5 ~ + 50 VDC	500 mA/channe	Yes			

**Note1:** DI channel can be used as DI or low speed (100 Hz) counter.

## ✓ AC/DC Digital Input



Model Name		AC Digital Input					
		Channels (Note1)	ON Voltage Level	OFF Voltage Level	Max. Input Voltage	Operating AC Frequency	Isolation Voltage
<b>I-7058</b> <b>I-7058D</b>	<b>M-7058</b> <b>M-7058D</b>	8 Differential	80 ~ 250 VAC/VDC	< 30 VAC/VDC	250 VAC/VDC	50/60 Hz	5000 Vrms
<b>I-7059</b> <b>I-7059D</b>	<b>M-7059</b> <b>M-7059D</b>		10 ~ 80 VAC 15 ~ 80 VDC	< 3 VAC/VDC	80 VAC/VDC		

**Note1:** DI channel can be used as DI or low speed (100 Hz) counter.

## ✓ Power Relay Output/DC Input



Model Name		Power Relay Output						DC Input	
		Channels	Contact Rating	Surge Strength	Operate Time	Release Time	Electrical Endurance	Channels	ON Voltage Level
<b>I-7060</b> <b>I-7060D</b>	<b>M-7060</b> <b>M-7060D</b>	RL1,RL2: Form A × 2 RL3,RL4: Form C × 2	0.6 A @ 125 VAC 2 A @ 30 VDC	1500 V	3 mS	2 mS	5 × 10 <sup>5</sup> ops.	4 (3750 Vrms)	+4 ~ 30 V
	<b>M-7060P</b>		16 A @ 250 VAC 10 A @ 30 VDC	2500 V	10 mS	5 mS	1 × 10 <sup>5</sup> ops.		+10 ~ 50 V
<b>I-7061</b> <b>I-7061D</b>	<b>M-7061</b> <b>M-7061D</b>	Form A × 12	5 A @ 250 VAC 5 A @ 30 VDC	3000 V	10 mS	5 mS	10 <sup>5</sup> ops.	-	-
<b>I-7063</b> <b>I-7063D</b>		Form A × 3		4000 V	6 mS	3 mS		8 (3750 Vrms)	+4 ~ 30 V
<b>I-7065</b> <b>I-7065D</b>		Form A × 5						4 (3750 Vrms)	
<b>I-7067</b> <b>I-7067D</b>	<b>M-7067</b> <b>M-7067D</b>	Form A × 7	0.5 A @ 120 VAC 1.0 A @ 24 VDC	1500 V	5 mS	2 mS	2 × 10 <sup>5</sup> ops.	-	-
	<b>M-7068</b> <b>M-7068D</b>	Form A × 4	0.25 A @ 250 VAC 2 A @ 30 VDC	2000 V	3 mS	4 mS			
	<b>M-7069</b> <b>M-7069D</b>	Form C × 4	6 A @ 250 VAC 6 A @ 30 VDC	4000 V	5 mS	1 mS			

Solid-State Relay Output



Model Name		Solid-State Relay Output					DC Input		
		Channels	Load Voltage Range	Max Load Current	Min. Release Time	Min. Operate Time	Dielectric Strength	Digital Input Channels	ON Voltage Level
I-7063A	I-7063AD	3 AC-SSR	24 ~ 265 Vrms	1.0 Arms	1 mS	1/2 cycle +1 mS	2500 Vrms	8 Isolation with common Source (3750 Vrms)	+4 ~ 30 V
I-7063B	I-7063BD	3 DC-SSR	3 ~ 30 VDC	1.0 A		1 mS			
I-7065A	I-7065AD	5 AC-SSR	24 ~ 265 Vrms	1.0 Arms		1/2 cycle +1 mS			
I-7065B	M-7065B I-7065BD M-7065BD	3 DC-SSR	3 ~ 30 VDC	1.0 A		1 mS	4 Isolation with common Source (3750 Vrms)		

PhotoMos Relay Output



Model Name		PhotoMos Relay Output					
		Channels	Load Current	Load Voltage	Isolation Voltage	Release Time	Operate Time
I-7066	I-7066D	7	0.13 A	350 V Max.	5000 Vdc	0.2 mS typical	0.05 mS typical
	M-7066P		1 A	80 V Max.	2000 Vdc	2 mS typical	0.06 mS typical

Counter/Frequency



Model Name		Counter/Frequency						
		Channel	Signal	Maximum Count	Voltage Level	Speed	Frequency Accuracy	Virtual Battery Backup
I-7080	M-7080	2	Up	32-bit	3.5 ~ 30 VDC	100 kHz	1 Hz	-
I-7080B	M-7080B							Yes
	M-7084	4/8	Up, CW/CCW, A/B, Pulse/Dir			250 kHz	0.1 Hz	Yes

Encoder Counter



Model Name		Encoder Counter						
		Input axis	Input Type	Encoder Mode	Isolated Input voltage	Maximum Count	Speed	Virtual Battery Backup
I-7083	I-7083D	3-axis	Isolated	Quadrant,cw/ccw, pulse/dir	> 12 V add external resistor	32-bit	1 MHz	-
I-7083B	I-7083BD							Yes

PWM Output/Counter Input



Model Name		PWM Output				Counter Input					
		Channels	Voltage Level	Duty Cycle	Speed	Channels	Maximum Count	Signal	Voltage Level	Speed	Virtual Battery Backup
I-7088	M-7088	8	0 ~ 5 VDC	0.1 ~ 99.9%	1 ~ 500 KHz	8	32-bit	Up	0 ~ 5 VDC	1 MHz	-
I-7088/S	M-7088/S		5 ~ 50 VDC						5 ~ 50 VDC		



# 1.2 RS-485 I/O Expansion Unit

## Introduction:

The RU-87Pn series, RS-485 remote I/O expansion unit, is designed to acquire and control remote I/O through RS-485 connections. It comprises

- A CPU module with non-volatile memory to backup/restore I/O module configurations; LED indicators to diagnose the I/O module; and a RS-485 port for 1.2 Km long distance communication.
- A power module
- A backplane with a number of I/O slots for flexible I/O configuration.

## Features:

### 1 Hot Swap

Reliable 3-piece construction enables users to hot swap modules during operation, without rewiring. All I/O module data are backed up in the non-volatile memory of the RU-87Pn. After hot-swapping a module, all settings are automatically loaded to recover.

### 2 Auto Configuration

The I-87K I/O modules can be pre-configured and backed up in the non-volatile memory of the RU-87Pn. When the RU-87Pn is power on or plugged in, the RU-87Pn will automatically checks and restores these configurations to each I-87K I/O modules on it.

### 3 Easy Duplicate System

Using the DCON Utility, you can easily make a backup of the I-87K module configurations and write to another RU-87Pn. This design can easily and quickly duplicate many RU-87Pn.

### 4 Easy Maintenance and Diagnosis

The basic configurations (includes station number, baudrate) are set by the rotary and DIP switches. The operator can use only one screwdriver to set the RU-87Pn. And there are several LED status indicators to show whether I-87K modules are configured and work properly.

If one I-87K module fails, the operator just needs to replace it with one good I-87K module with the same item number. And then checks the LED indicators to know whether the replacement is performed correctly.

### 5 Communication

#### • RS-485 industrial multi-drop network

The RU-87Pn uses the industrial EIA RS-485 communication to transmit and receive data over long distance (1.2 Km).

#### • DCON protocol

I-87K series I/O modules plugged in a RU-87Pn provides a simple command/response protocol (named DCON protocol) for communication. All command/response are in easy use ASCII format.

## Appearance:

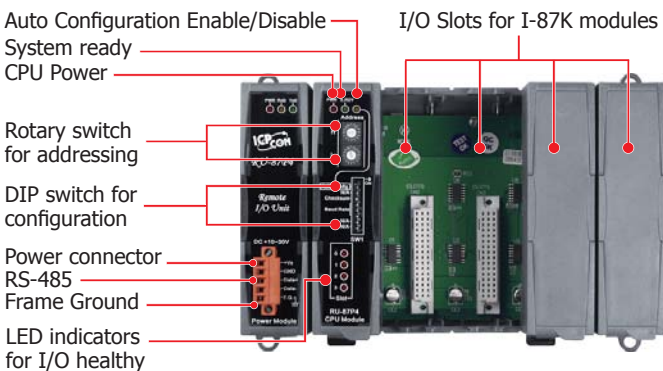

## Patent

Taiwan	096134568
China	200710181138.6
USA	11/979,474

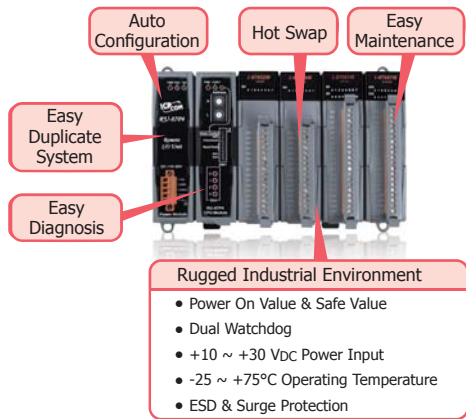
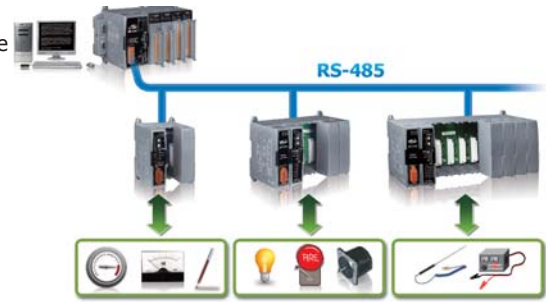

Rugged Industrial Environment	
•	Power On Value & Safe Value
•	Dual Watchdog
•	+10 ~ +30 VDC Power Input
•	-25 ~ +75°C Operating Temperature
•	ESD & Surge Protection



### 6 Fully Software Support

The free charge software utility and development kits include

A: DCON Utility: for configuration

B: OPC Servers:

OPC is an industrial standard interface based on OLE technology. With the OPC server, I/O modules can be easily integrated to any software that has OPC client capability.

C. EZ Data Logger

EZ Data Logger is a small data logger software. It can be applied to small remote I/O system. With its user-friendly interface, users can quickly and easily build a data logger software without any programming skill.

D. Various Software Development Toolkits

DLL, ActiveX, LabVIEW driver, InduSoft driver, DASyLab driver, Linux driver

## Ordering Information:

Model No.	Description
<b>RU-87P1 CR</b>	1 slot I/O Expansion Unit (RoHS)
<b>RU-87P2 CR</b>	2 slots I/O Expansion Unit (RoHS)
<b>RU-87P4 CR</b>	4 slots I/O Expansion Unit (RoHS)
<b>RU-87P8 CR</b>	8 slots I/O Expansion Unit (RoHS)

# 1.3 M-2000 Series I/O Modules

## Introduction:



The M-2000 series is a family of network data acquisition and control modules with digital or analog I/O functions. The modules can be remotely controlled through an RS-485 serial bus by using DCON and Modbus RTU/ASCII protocols. The selectable transmission speed of the RS-485 port is up to 115,200 bps. Modbus has facto standard communications protocol in industry, and is now the most commonly available means of connecting industrial electronic devices. The M-2000 series is slim-type Form Factor I/O that provides the saving space for the installation, easy wiring and distributed I/O points applications. The bias resistor and terminal resistor by switch selectable that is used to improve the communication and solve the communication fail of RS-485 network.

## Features:

- RS-485 Industrial Multi-Drop Network
- Communication Protocols: **DCON, Modbus RTU**
- Programmable I/O Type and Range
- Programmable Power-on Value and Safe Value
- Dual Watchdog Design
- 240 Vrms OverVoltage Protection for AI Modules
- Slim-Type Form Factor

## Applications:

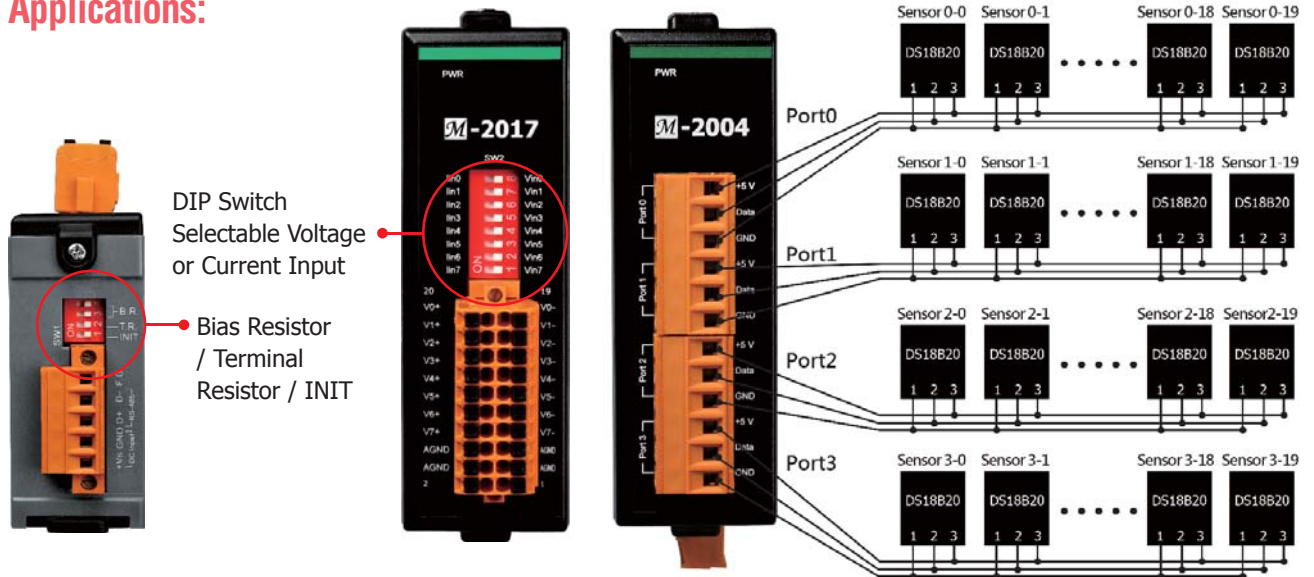

## Selection Guide:

Model Name	Analog Input					
	Channel	Voltage & Current Input	Sensor Input	Sensor Wiring with Daisy-Chain	Number of Sensors per channel	Total Sensors for all channels
<b>M-2004</b>	4	–	2/3-wire DS18B20	Yes	20	80
<b>M-2017</b>	8	±150 mV, ±500 mV, ±1 V, ±5 V, ±10 V, ±20 mA, 0 ~ 20 mA, 4 ~ 20 mA	–	–	1	8
<b>M-2018-16</b>	16	±15 mV, ±50 mV, ±100 mV, ±500 mV, ±1 V, ±2.5 V ±20 mA, 0 ~ +20 mA, +4 ~ +20 mA (requires an optional external 125 Ω resistor)	Thermocouple: J, K, T, E, R, S, B, N, C, L, M, LDIN43710	–	1	16

# 1.4 M-6000 Series I/O Modules

## Introduction:





The M-6000 series of distributed I/O provides a wide variety of input, output, and smart control solutions, all of which are based on a single universal hardware platform. The M-6000 series combines inputs and outputs, saving your time and space when both are at a premium. Since M-6000 series feature both inputs and outputs on the same board, retailers can reduce the space requirement for I/O boards by as much as 50%! Traditional I/O board schemes required retail operators to mount separate input and output boards within an enclosure, increasing the time and cost to mount the boards. The M-6000 I/O boards are communications devices needed to connect to the facility management system to control refrigeration, HVAC and lighting systems.

## Features:

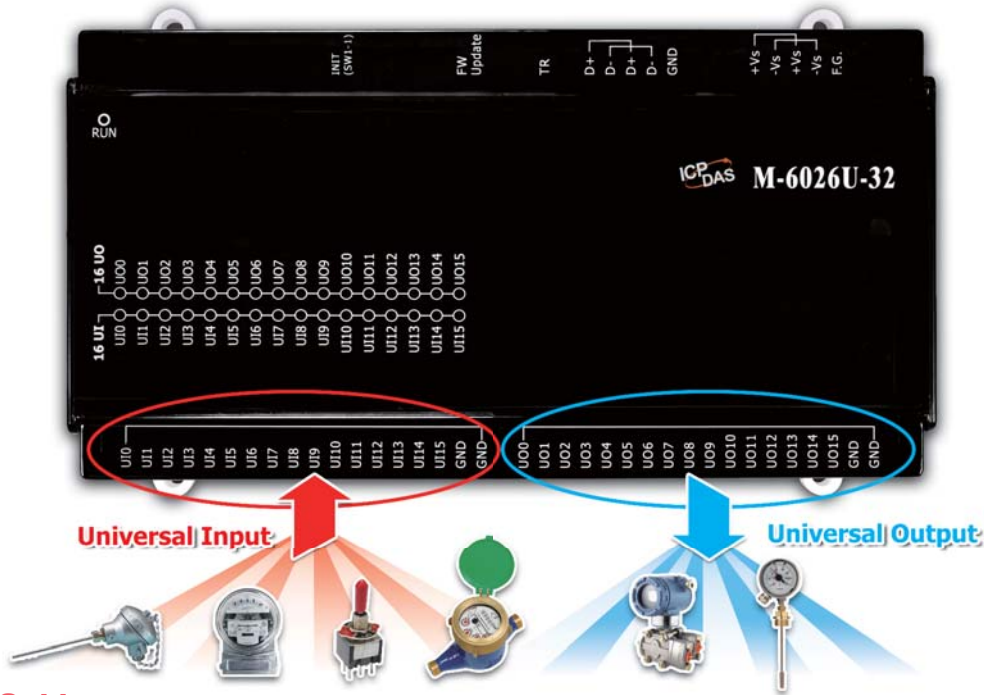
- RS-485 Industrial Multi-Drop Network
- Communication Protocols: **Modbus RTU**
- Universal Inputs and Universal Outputs
- Status LED for Universal inputs and outputs
- HVAC control, lighting control, door monitoring
- Integrated Design Allows You to Take Advantage of Inputs and Outputs
- Any Universal I/O point can be configured as analog input/output, digital input or counter input



## Selection Guide:

Model Name	Multi-function Input					
	Universal Input				Universal Output	
	Channel	Voltage & Current Input	Sensor Input	Digital input	Channel	Voltage & Current Output
 <b>M-6026U-32</b>	16 (Note)	0 ~ 10 V, 2 ~ 10 V, ±20 mA, 0 ~ 20 mA, 4 ~ 20 mA	PT1000	Dry Contact, Counter input	16 (Note)	0 ~ 20 mA, 4 ~ 20 mA, 0 ~ 10 V, 2 ~ 10 V
 <b>M-6018-16</b>	16	±15 mV, ±50 mV, ±100 mV, ±500 mV, ±1 V, ±2.5 V ±20 mA, 0 ~ +20 mA, +4 ~ +20 mA (requires an optional external 125 Ω resistor)	Thermocouple: J, K, T, E, R, S, B, N, C, L, M, LDIN43710	-	-	-

Note: The number of UI and UO channels is depending on wiring and the software configuration.



# 1.5 tM Series Modules

## Introduction:



The tM series is a family of network data acquisition and control modules with digital or analog I/O functions. The modules can be remotely controlled through an RS-485 serial bus by using DCON and Modbus RTU/ASCII protocols. The selectable transmission speed of the RS-485 port is up to 115,200 bps. Modbus has facto standard communications protocol in industry, and is now the most commonly available means of connecting industrial electronic devices.

The tM series tiny RS-485 I/O modules support various I/O types, like photo-isolated digital input, power relay, photoMOS relay, open collector output, and analog input (voltage and current). Compared with the M-7000 series, the tM series is more cost-effective with low channel count design that is suitable for distributed I/O points applications.

The tM series provides dual watchdog: module watchdog and host watchdog. The module watchdog is designed to automatically reset the microprocessor when the module hangs. The host watchdog monitors the host controller (PC or PLC), and the output of the module can go to predefined safe value state when the host fails.

## Features:

- RS-485 Industrial Multi-Drop Network
- Communication Protocols:  
**DCON, Modbus RTU/ASCII**
- Programmable I/O Type and Range
- Dual Watchdog Design
- DI Latch Function
- Low Speed Counter
- Programmable Power-on Value and Safe Value

## Dimensions (Units: mm):

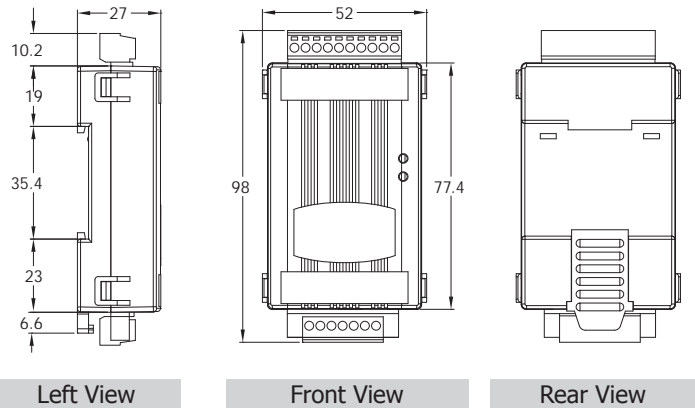

## Selection Guide:

tM Series Models				
Model Name	AI	AO	DI	DO
tM-AD2	2-ch (Single-Ended, Voltage/Current)	-	-	-
tM-AD5	5-ch (Differential, Voltage)	-	-	-
tM-AD5C	5-ch (Differential, Current)	-	-	-
tM-AD8	8-ch (Single-Ended, Voltage)	-	-	-
tM-AD8C	8-ch (Single-Ended, Current)	-	-	-
tM-AD4P2C2	2-ch (Single-Ended, Voltage) 2-ch (Single-Ended, Current)	-	2-ch (Source)	2-ch (NPN, Sink)
tM-DA1P1R1	-	1-ch (Single-Ended, Voltage)	1-ch (Sink/Source)	1-ch Form A Relay
tM-TH8	8-ch (Thermistor)	-	-	-
tM-P8	-	-	8-ch (Sink/Source)	-
tM-C8	-	-	-	8-ch (NPN, Sink)
tM-P4C4	-	-	4-ch (Source)	4-ch (NPN, Sink)
tM-P4A4	-	-	4-ch (Sink)	4-ch (PNP, Source)
tM-P3R3	-	-	3-ch (Sink/Source)	3-ch Form A Relay
tM-R5	-	-	-	5-ch Form A Relay
tM-POR3	-	-	3-ch (Sink/Source)	3-ch PhotoMos Relay

# 1.6 LC/SC/DALI Series: Smart Lighting Control



The Smart Lighting Control products by ICP DAS are easy-to-use modules designed for building automation in quick wiring, installation and setup. The LC and SC series support Modbus and DCON protocols; the DALI series is a DALI converter product. According to different demands, users can select to control directly by the digital input or via RS-485 communication. The main applications are the group lighting, dimmer scenes, electric curtains, air-condition fans of temperature & humidity, windows security and other automation controls. Combining with the Hub model and TouchPAD model of ICP DAS can design a smart home/building automation system.

## Features:

### ▶ Easy Installation

With RJ-11 connector, it's easy to deploy power and data to every LC device.

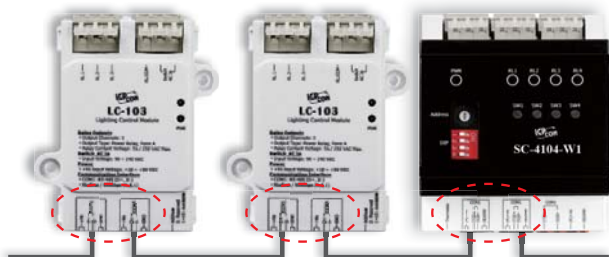

RS-485 and Power Input Daisy Chain using an RJ-11 Connector

### ▶ Easy Configuration

The configuration can be done by communication via the RS-485 or easily done by DIP and Rotary switches.

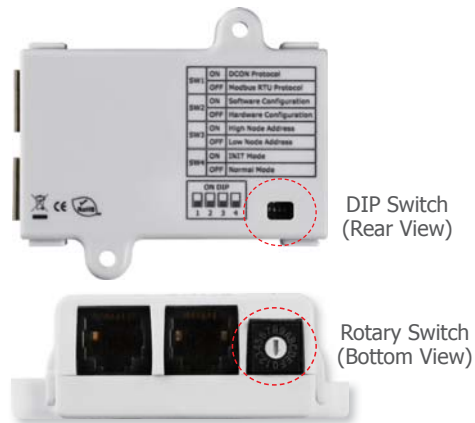

### ▶ Support Modbus RTU and DCON communication protocols

Support the industry standard Modbus protocol and the DCON string protocol for easy integrating the third-party devices.

### ▶ Control via digital input and RS-485 communication

Provide two methods to control the Relay output: directly from the digital input, or via the RS-485 communication, or both.

### Selection Guide:

#### ☑ Lighting Control

Model	Relay Output			AC Digital Input			
	Ch.	Type	Max. Load Current	Ch.	Type	On Voltage Level	Off Voltage Level
LC-101	1	Power Relay, Form C	NO: 10 A; NC: 6 A	1	90 ~ 240 VAC	85 VAC	60 VAC
LC-103	3	Power Relay, Form A	5 A	1	90 ~ 240 VAC	85 VAC	60 VAC

#### ☑ Lighting Control: Load Current Feedback Measurement

Model	Relay Output with Load Current Feedback			Current/Digital/Thermistor Input	
	Ch.	Type	Range	Ch.	Range
LC-305	-	-	-	5	Load Current Input: 0 ~ 5 A
SC-4102-W5	2	Power Relay, Form A	Load Current Feedback, Range: 0 ~ 20 A	2	AC Digital Input, Type: 90 ~ 240 VAC
				1	Thermistor Input, Temperature: -40°C ~ +80°C

#### ☑ Lighting Control: Analog Dimmer

Model	Relay Output			Analog Output			Digital Input		
	Ch.	Type	Load Current	Ch.	Type	Resolution	Ch.	Type	Voltage Level
LC-221	1	Power Relay, Form A	Max. 16 A	1	0 ~ 20 mA, 4 ~ 20 mA, 0 ~ 10 V 1 ~ 10 V	12-bit	1	90 ~ 240 VAC	ON:85 / OFF:45 VAC
LC-223	1	Power Relay, Form A	Max. 16 A	1		12-bit	1	90 ~ 240 VAC	ON:85 / OFF:45 VAC
							2	Dry Contact	ON: Close to AGND OFF: Open

#### ☑ Lighting Control: Digital Dimmer (DALI Gateway)

Model	Input Channel	Output Channel	Connector	Other
DGW-521	1 × RS-485/RS-232 1 × USB (Virtual COM)	1 × DALI	2-pin Terminal Block	Built-in DALI power (DC 16 Vdc ±5%, max. current 250 mA)

#### ☑ Security

Model	Relay Output			Digital Input			
	Ch.	Type	Max. Load Current	Ch.	Type	On Voltage Level	Off Voltage Level
LC-131	1	Power Relay, Form A	16 A	3	Dry Contact	Close to DI.COM	Open

#### ☑ RS-485 Hub

Model	Input Channel	Output Channel	Connector	Speed
LC-485	1 × RS-485	4 × RS-485	RJ-11	1200 ~ 115200 bps

#### ☑ Smart Control: FCU, Lighting, Temperature

Model	Relay Output			AC Digital Input		Thermistor Input	
	Ch.	Type	Load Current	Ch.	Type	Ch.	Temperature Range
SC-4104-W1	4	Power Relay, 1 Form C, 3 Form A	Form C: NO: 7 A, NC: 5 A, Form A: 7 A	1	90 ~ 240 VAC	1	-40 ~ +80°C
SC-6104-W5	4	Power Relay, 4 Form C	NO: 20 A, NC: 16 A	1	90 ~ 240 VAC	1	-40 ~ +80°C



## 1.6.1 LC Series: Lighting Control Module

### Lighting Control Dimmer Control Security / Hub

**LC-101/LC-103** is a easy-to-use lighting module, and control relay output without any software.

**LC-221** provides two methods of controlling the brightness of fluorescent lamps via a dimmer, either through DI or controller.

**LC-131** is a DI control module equip with 3-channel short circuit digital input and 1-channel relay output.

**LC-485** is a 4-ch star topology hub and power supplier, equip with RS-485 short circuit function, shut down faulty channel automatically, and protect the whole communication system.

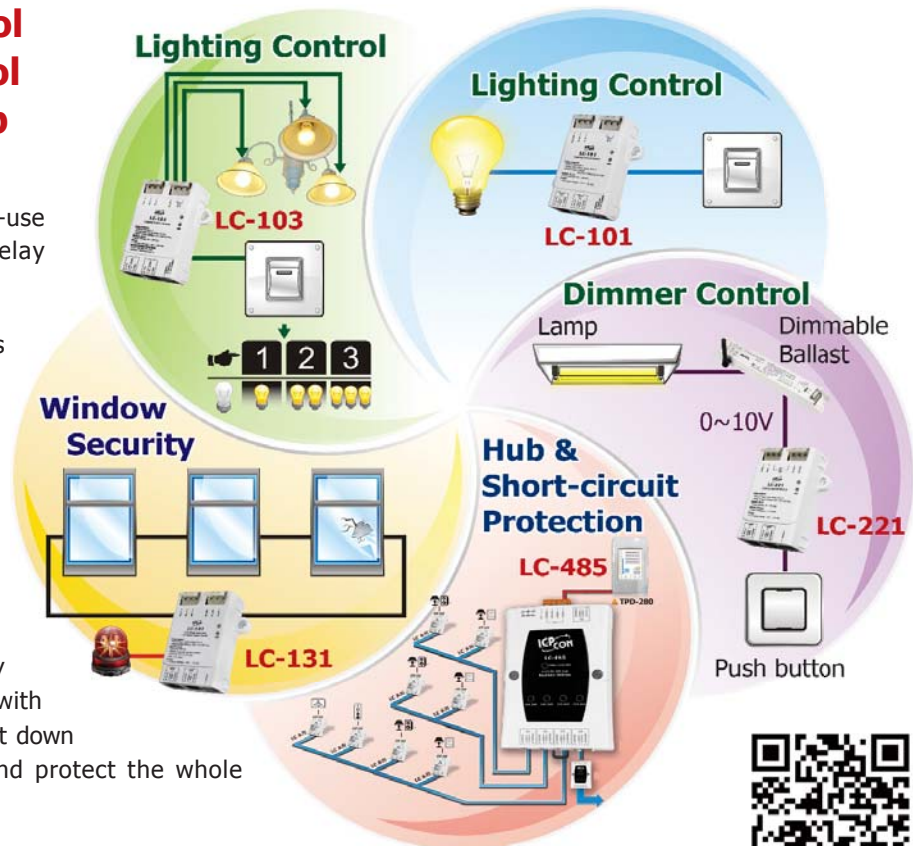

**LC-223** provides the two-stage function for dimmer control.

When no people enter the detection range, the lamp will stay in 10% brightness.

When the people enter the detection range, the lights will transfer to the preset brightness (20% ~ 100%).

When the people leave the detection range, the fixture will return to 10% brightness after the setting lighting time and keep the brightness until the ambient is bright.

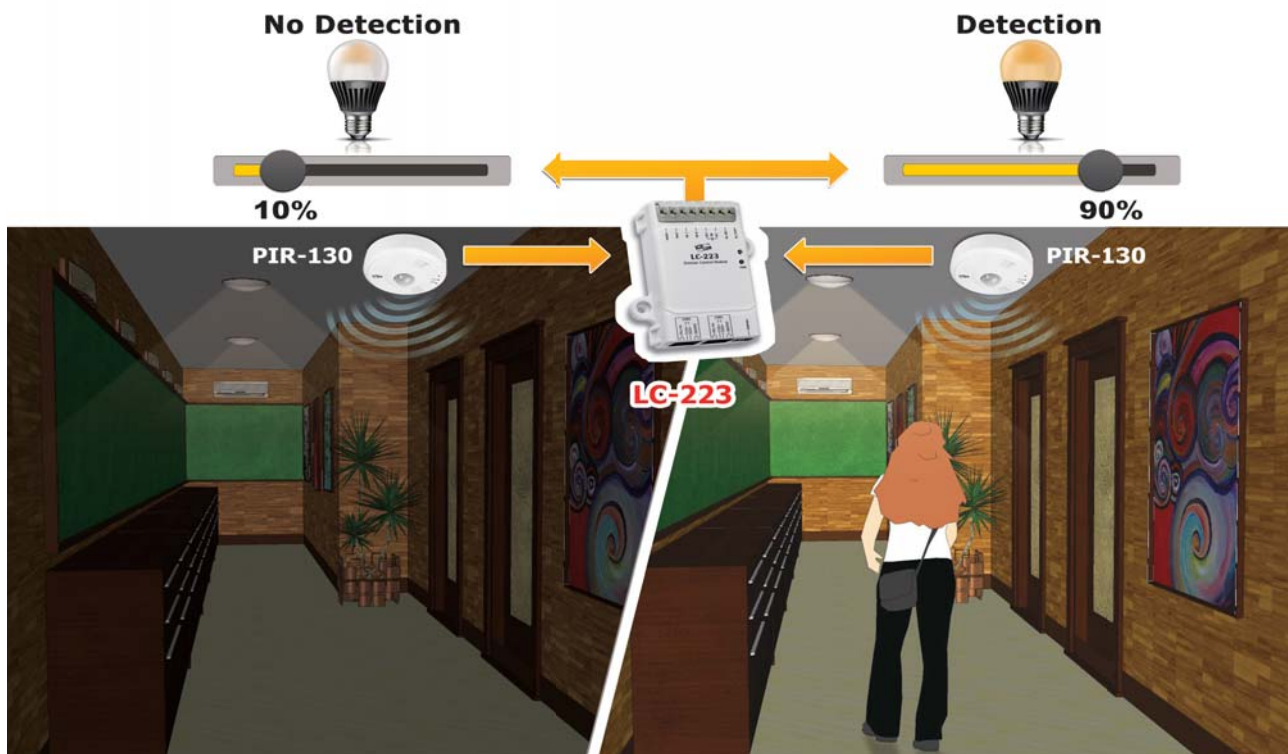

**LC-305** is a 5-ch load current measurement module that can measure the load current of each lamp to confirm whether each lamp is normal or fail.

When the load current of channel 1 is  $I_1 = I_1$ , it means that the lamp of channel 1 is working normally.

When the load current of channel 2 is  $I_2 = 1.5 \times I_2$ , it means that it needs to make sure the brightness is sufficient and replace the lamp of channel 2 or not.

When the load current of channel 3 is  $I_3 = 2 \times I_3$ , it means that the lamp of channel 2 is working normally.

When the load current of channel 5 is  $I_5 = 0A$ , it means that the lamp of channel 5 have been broken and need to replace.

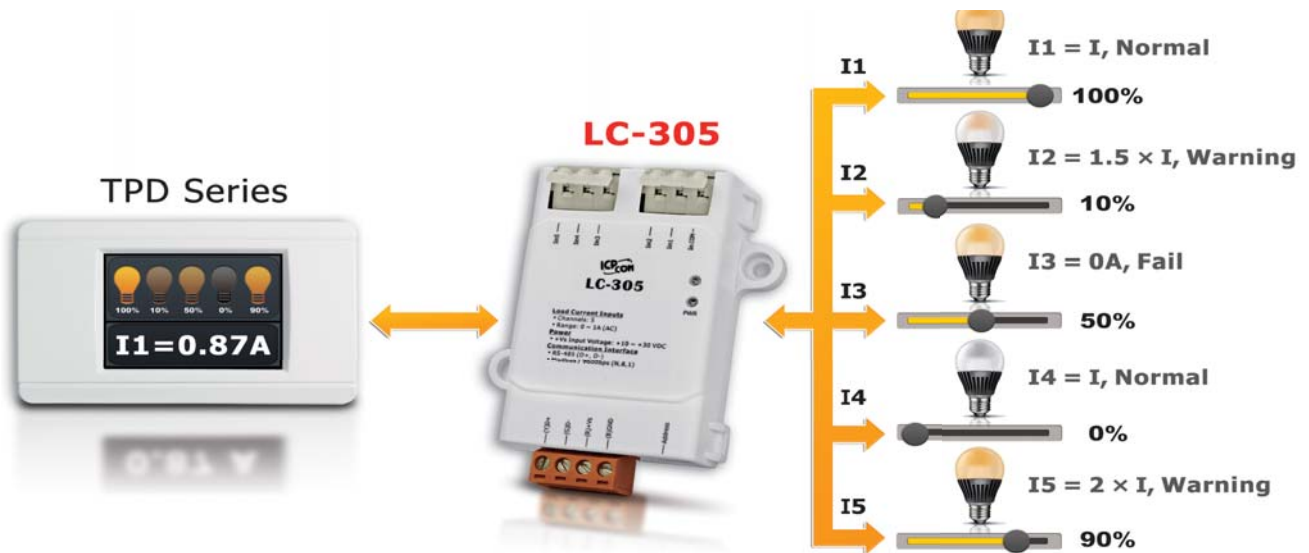

## 1.6.2 DALI Series



### DALI Gateway **DGW-521**

#### Features:



**DGW-521**

- Conversion between RS-485/RS-232/USB and DALI Interfaces
- Easy Deployment: ID Code can be written by the RS-485 Interface
- Simplified Wiring Process
- Built-in DALI Power can be enabled or disabled using a Switch
- 1500 VDC Isolation
- $\pm 4$  ESD Protection for the RS-232/485/USB Data Line
- $\pm 4$  kV EFT Protection and  $\pm 2$  kV Surge Protection for Power Line
- DIN-Rail Mounting
- Wide Operating Temperature Range:  $-25^{\circ}\text{C} \sim +75^{\circ}\text{C}$

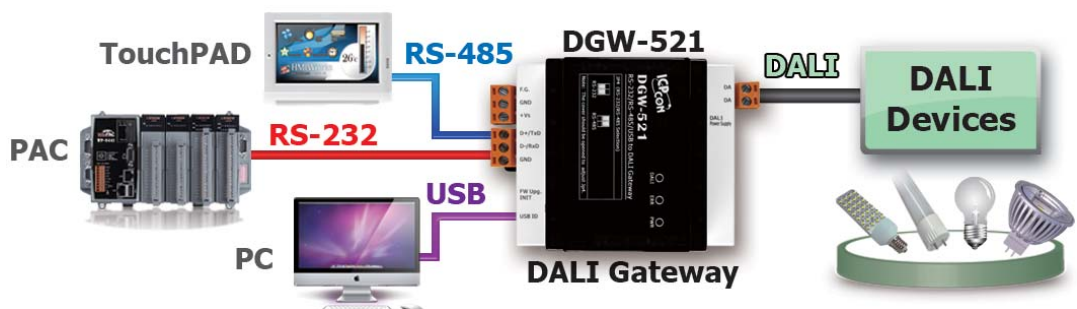

## 1.6.3 SC Series (Smart Control Multi-function Module)



### FCU Control / Lighting Control Temperature Sensing



**SC-4104-W1**  
**SC-4102-W5**

**SC-6104-W5**

### Features:

- Cost-effective for lighting/FCU control
- Power Relay Outputs
- Power Relay Outputs
- -40°C ~ +80°C Temperature Detector
- Support DCON and Modbus RTU Protocol
- 7 Kinds DI/DO coordinated functions



**SC-4104-W1/SC-6104-W5** are 1-ch FCU (Fan Control Unit) modules. Combine SC and TPD series together, no programming is required to set up operations such as adjusting temperature or start/stop the FCU. Also, the preloaded intuitive interfaces make it easy for operations in schedule setting, temperature compensation and remote control.

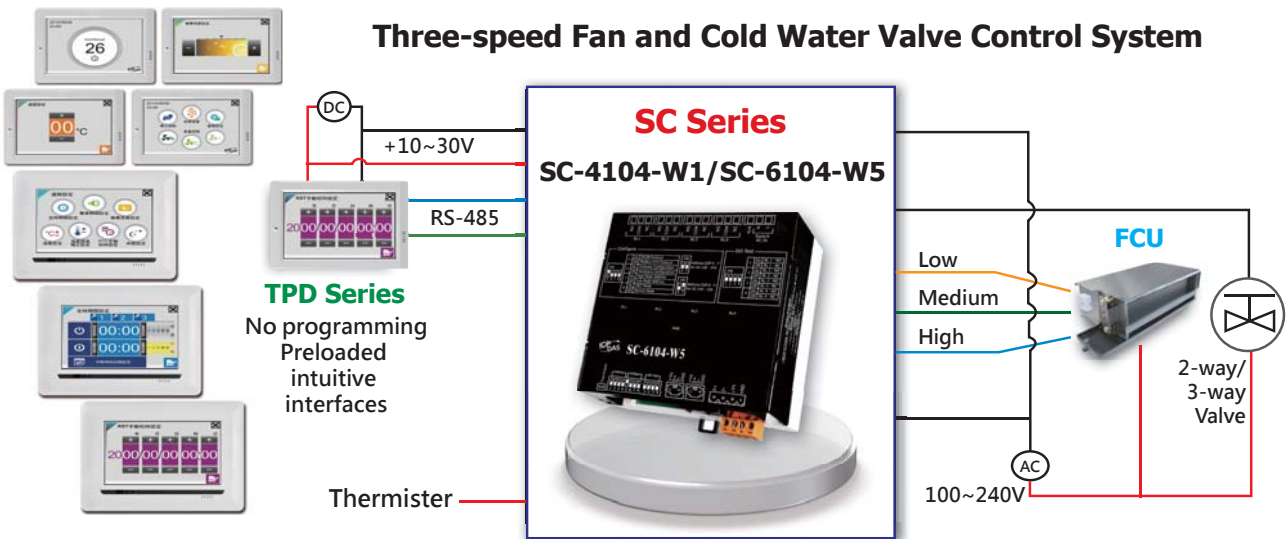

**SC-4102-W5** is a 2-ch relay output loop with load current measurement module that provides the total current of all lamps on the control loop circuit and can use the relay to turn ON/OFF the current loop. In the lighting control application, the value of the load current feedback can help to know whether the equipment on the loop circuit is working well or fail, whether the ageing equipment needs to replace a new one, whether the relay is still sticky on, and so on.

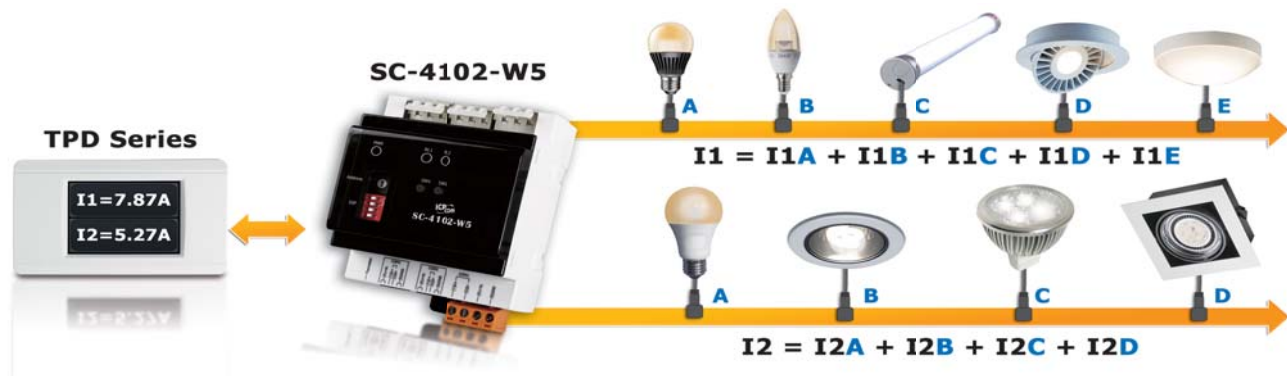



## 2. Ethernet I/O Products

Although the RS-485 remote I/O module is still selling well, we found more and more demand of Ethernet based remote I/O modules. Our Ethernet remote I/O modules support Modbus TCP, Modbus UDP protocol. We also provide web HMI, Web server, OPC server, security mechanism..etc. According to different application, we have developed various Ethernet I/O units and modules, such as compact size ET-87Pn-MTCP and ET-8KPn-MTCP, palm-size ET-7000/PET-7000/ET-7200/PET-7200 series , tiny-size tET/tPET and slim-type ET-2200 series. The module has diversified I/O interface, such as overvoltage-protection analog input, relay output, digital input/output, counter, timer.

The brief comparison is as the following table. Besides those regular Ethernet I/O modules, we will release EtherCAT, Ethernet/IP and PROFINET I/O modules.

Model Name	tET/tPET	ET-2200	ET-7000 PET-7000	ET-7200 PET-7200
Pictures				
<b>Communication</b>				
Ethernet	10/100 M, RJ-45 × 1	10/100 M, RJ-45 x2	10/100 M, RJ-45 × 1	10/100 M, RJ-45 × 2
Protocol	Modbus TCP, Modbus UDP			
Security	Web Password and IP Filter		ID, Password and IP Filter	
Max. Sockets	10		12	
Web Server	Yes		Yes	
User-defined Web pages	-		Yes (Web HMI)	
<b>I/O</b>				
I/O pins	10 pins	20 pins	21 pins	22 pins
DI Counter	32-bit, 3 kHz	32-bit, 3 kHz	32-bit, 500 Hz	32-bit, 100 Hz
DIO LED Indicators	-	-	-	Yes
Pair Connection	Yes (Polling/Push Mode)	Yes (Polling/Push Mode)	Yes (Polling Mode)	
<b>Mechanical</b>				
Reset Button	-	-	-	Yes
Power Input Pins	1 pair	1 pair	1 pair	2 pair
Dimensions (W × L × D)	52 × 98 × 27 mm	127 × 33 × 99 mm	72 × 123 × 35 mm	76 × 120 × 38 mm

Furthermore, we also developed ET-87Pn-MTCP and ET-8KPn-MTCP, a series of Ethernet remote I/O unit for compact and modular I/O expansion. It comprises a CPU, a power module and a backplane with a number of I/O slots for flexible I/O configuration.

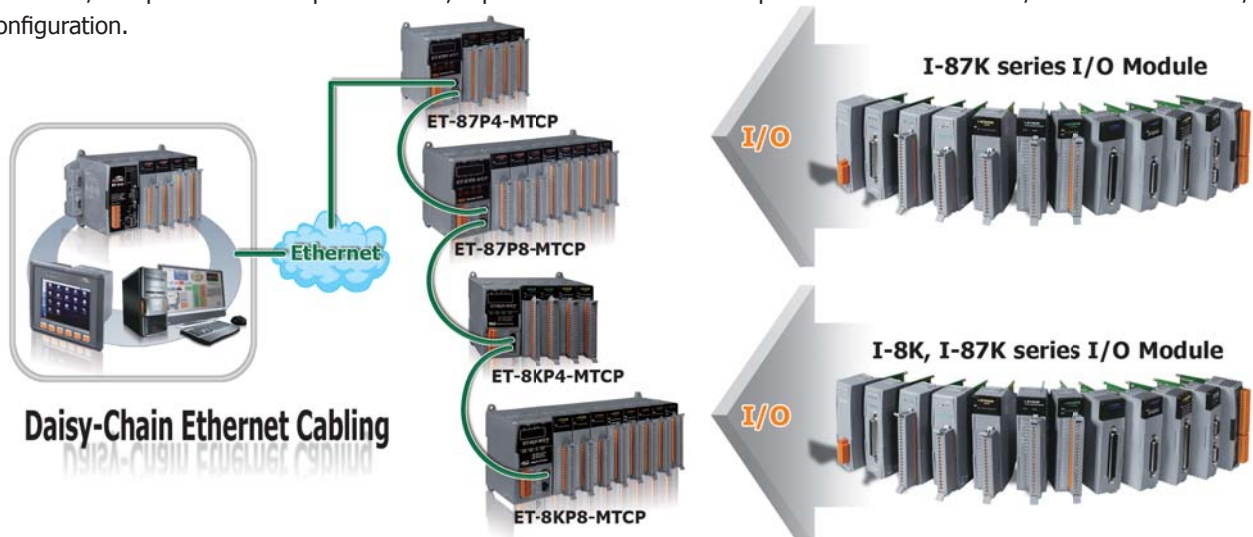

# 2.1 Ethernet Modbus TCP I/O Modules

## Introduction:



The ET-7000/ET-7200, a web-based Ethernet I/O module, features a built-in web server which allows configuration, I/O monitoring and I/O control by simply using a regular web browser. Remote control is as easy as surfing the Internet.

Besides Web HMI function, no more programming or HTML skills are required; creating dynamic and attractive web pages for I/O monitoring and I/O control would be fun to engineers ever after. In addition, the ET-7000/ET-7200 also supports Modbus TCP protocol that makes perfect integration to SCADA software.

Furthermore, PET-7000/PET-7200 features "PoE" that not only Ethernet but also power is carried through an Ethernet cable.

## Features:

### 1. Power over Ethernet (PoE)

The PET-7000/PET-7200 series module can be powered by an IEEE802.3af compliant PoE switch. Both Ethernet and power can be carried by an Ethernet cable eliminating the need for additional wiring and power supply.



### 2. Daisy-Chain Ethernet Cabling

The ET-7200/PET-7200 Series has a built-in two-port Ethernet switch to implement daisy-chain topology. The cabling is much easier and total costs of cable and switch are significantly reduced.

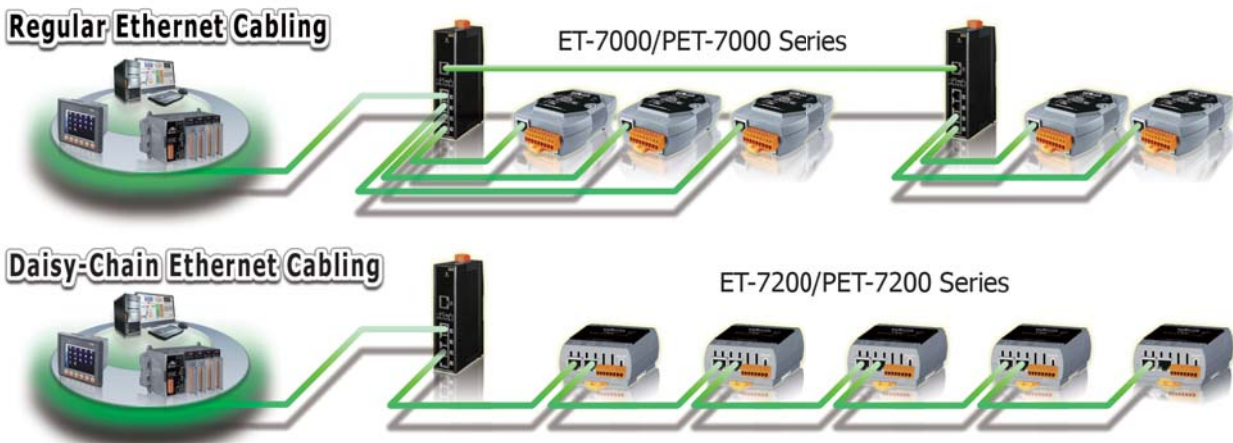

### 3. LAN Bypass

LAN Bypass feature guarantees the Ethernet communication. It will automatically active to continue the network traffic when the ET-7200/PET-7200 loses its power.



### 4. Communication Security

Account and password are needed when logging into the web server. An IP address filter is also included, which can be used to allow or deny connections with specific IP addresses.

### 5. Support for both Modbus TCP and Modbus UDP Protocols

The Modbus TCP, Modbus UDP slave function on the Ethernet port can be used to provide data to remote SCADA software.

### 6. Built-in I/O

Various I/O components are mixed with multiple channels in a single I/O module, which provides the most cost effective I/O usage and enhances performance of the I/O operations.

### 7. Dual Watchdog

The Dual Watchdog consists of a Module Watchdog and a Communication Watchdog. The action of AO,DO are also associated to the Dual Watchdog.

**Module Watchdog** is a built-in hardware circuit to monitor the operation of the module and will reset the CPU if a failure occurs in the hardware or the software. Then the Power-on Value of AO,DO will be loaded.

**Communication Watchdog** is a software function to monitor the communication between the host and the I/O module. The timeout of the communication Watchdog is programmable, when the I/O doesn't receive commands from the host for a while, the watchdog forces the AO,DO to pre-programmed Safe Value to prevent unpredictable damage of the connected devices.

### 8. Highly Reliable Under Harsh Environment

- Wide Operating Temperature Range: -25 ~ +75°C
- Storage Temperature: -30 ~ +80°C
- Humidity 10 ~ 90% RH (Non-condensing)



### 10. Power-on Value and Safe Value

Besides setting by the set AO,DO commands, the AO,DO can be set under two other conditions.

**Power-on Value:** The Power-on Value is loaded into the AO,DO under 3 conditions: Power-on, reset by Module Watchdog, reset by reset command.

**Safe Value:** When the Communication Watchdog is enabled and a Communication Watchdog timeout occurs, the "safe value" is loaded into the AO,DO.

### 9. I/O Pair Connection

This function is used to create a AI/DI to AO/DO pair through the Ethernet. Once the configuration is completed, the I/O module can poll the status of remote AI/DI devices and then use the Modbus TCP protocol to continuously write to a local AO/DO channels in the background.

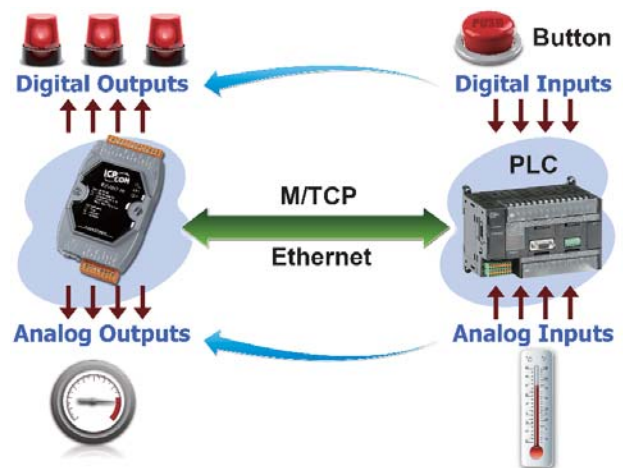

### 11. LED indicators for DIO status

The LED indicators for DIO status are for ET-7200/PET-7200 series.

### 12. Reset button

The reset button is for ET-7200/PET-7200 series. It is used to clear all data and restore all settings to the factory default values. It is very useful especially when you forget the ID, password to log in to the web server, or IP address to access the Ethernet I/O module.

### 13. Two pair of power input pins

For ET-7000/PET-7000 series, there are only two pins for power input. To ease the wiring, the pins are increased to four pins as two pairs for ET-7200/PET-7200 series.

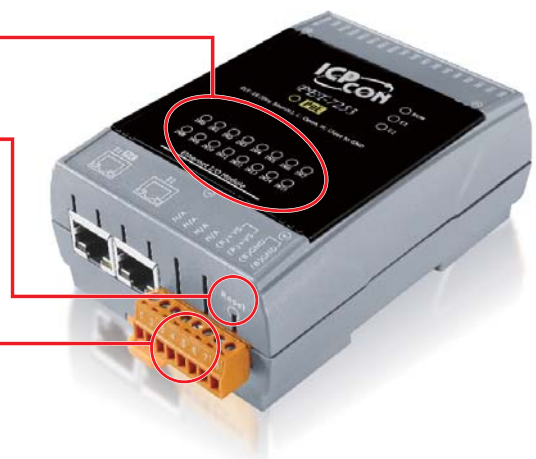



## 14. Web HMI

The Web HMI function allows the users to create dynamic and attractive web pages to monitor and control the I/O points. Users can upload specific I/O layout pictures (bmp, jpg, gif format) and define a description for each I/O point. No HTML or Java skills are needed to create the web pages.

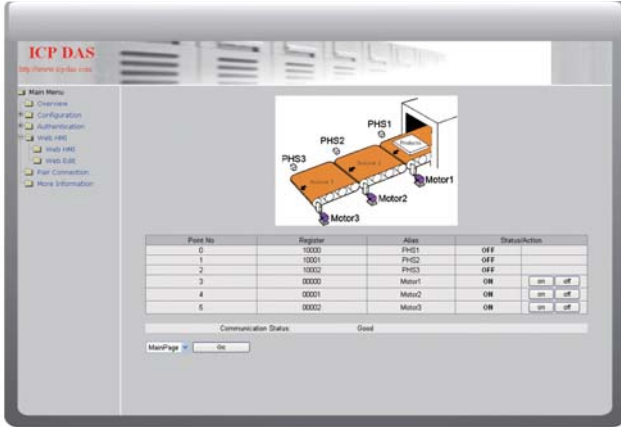

## 15. Built-in Web Server

Each I/O module has a Built-in web server that allows the users to easily configure, monitor and control the module from a remote location using a regular web browser.



## Appearance:

ET-7000/PET-7000 Series

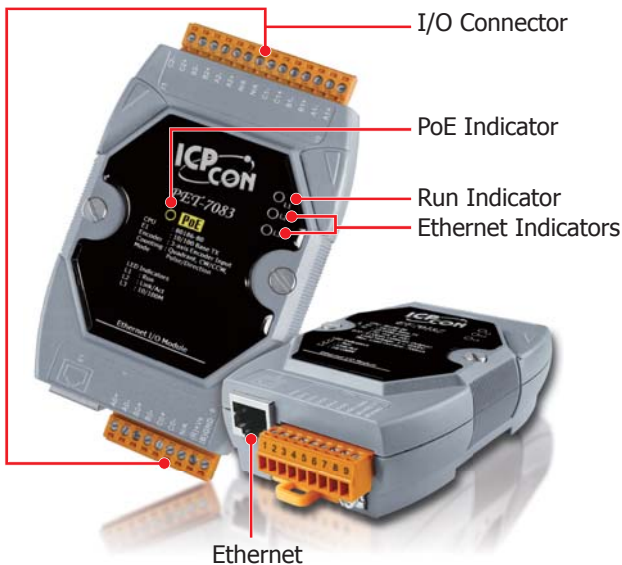

ET-7200/PET-7200 Series

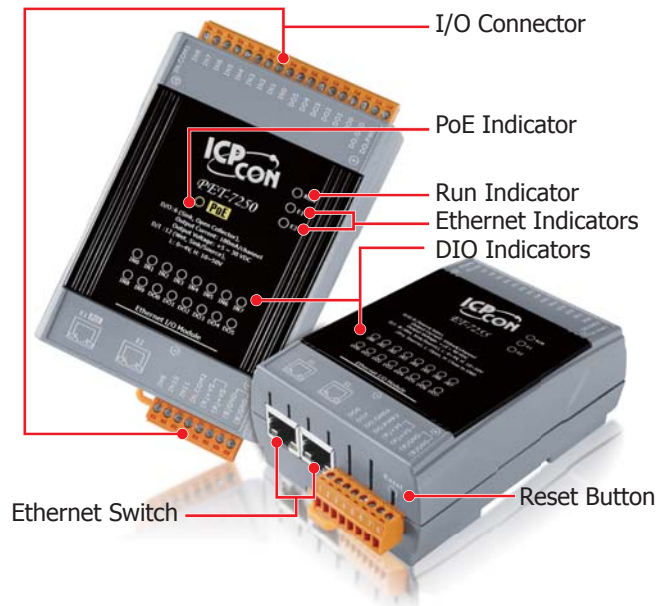

## Dimensions (Units: mm):

ET-7000/PET-7000 Series

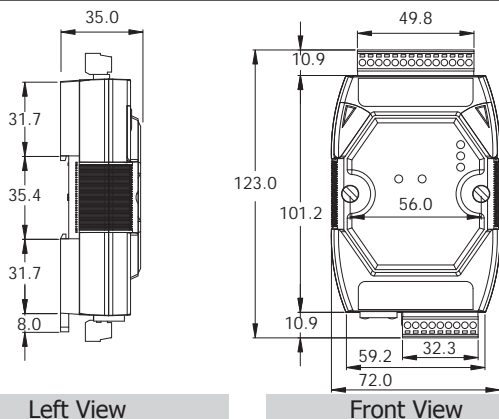

ET-7200/PET-7200 Series

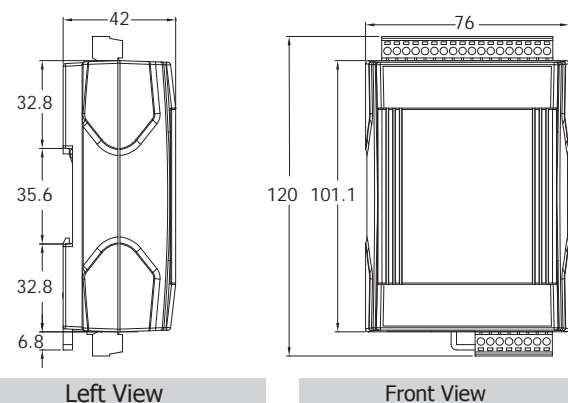

## Software Support:

Our free charge software utility and development kit include

### 1. OPC Server

**NAPOPC\_ST DA Server** is a **free** OPC DA Server ("OPC" stands for "OLE for Process Control" and "DA" stands for "Data Access") for ICP DAS products. Based on Microsoft's OLE COM (component object model) and DCOM (distributed component object model) technologies, NAPOPC\_ST DA Server defines a standard set of objects, interfaces and methods for use in process control and manufacturing automation applications to facilitate the interoperability.

Using NAPOPC\_ST DA Server, system integrates data with SCADA/HMI/Database software on the same computer and others. SCADA/HMI/Database sends a request and NAPOPC DA Server fulfills the request by gathering the data of ICP DAS modules (**License Free**) and third-party devices (**License Charge**) to SCADA/HMI/Database.

For different OS of PAC products, ICP DAS provides several professional DA Servers:

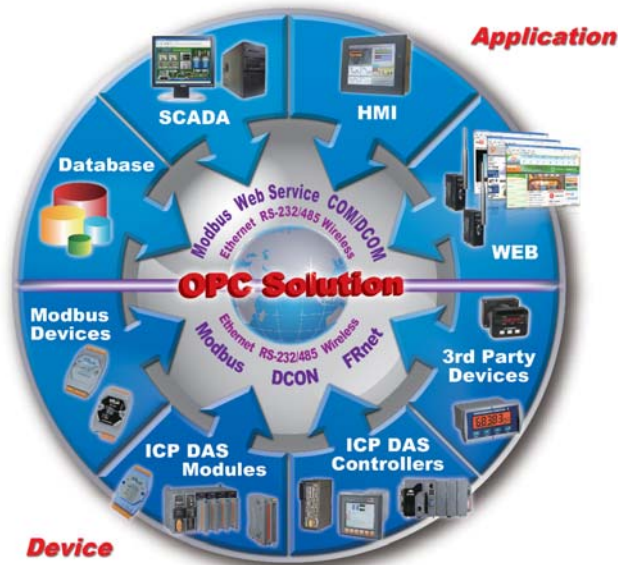

Version	NAPOPC_ST	NAPOPC_XPE	NAPOPC_CE5	NAPOPC_CE6
Platform	Desktop Windows	Windows XP Embedded	Windows CE5	Windows CE6
Price	Free/\$	Free	Free	Free

For more Information please visit <http://opc.icpdas.com>

### 2. EZ Data Logger

EZ Data Logger is the software that ICP DAS provides for users to easily build a small SCADA system on Windows 2000/XP/Vista. It comes with two versions, "Lite" & "Professional". The Lite version is not only full-functioned but free to all ICP DAS users!

EZ Data Logger is a small data logger software. It can be applied to small remote I/O system. With its user-friendly interface, users can quickly and easily build a data logger software without any programming skill.

### 3. Modbus Software Development Toolkits

Plenty of library functions and demo programs are provided to let user develop programs easily under Windows, Linux and MiniOS7 operating systems.

OS	Development Language	SDK
MiniOS7	TC, BC	MBT7_xxx.lib, MBT8_xxx.lib and Demos
WinCE 5.0/6.0	VS .NET 2005/2008	nModbusCE.dll and Demos
WES 2009, Windows XP/Vista/7	VS .NET 2005/2008	nModbus.dll and Demos
	LabVIEW	Demos
Linux	C	Libraries and Demos

## Selection Guide:



**PET: PoE Version**  
**ET: Regular Ethernet Version**

**7**



**0: 1-port Ethernet**  
**2: 2-port Ethernet Switch**



**Model Number**



**Analog Input Model**



Model Name		AI			DO		
		Channel	Voltage and Current Input	Sensor Input	Channel	Type	Sink/Source
ET-7005 PET-7005	-	8	-	Thermistor	4	Open Collector	Sink
ET-7015 PET-7015	ET-7215 PET-7215	7	-	RTD: Pt100, Pt1000, Ni120, Cu100, Cu1000	-	-	-
ET-7017 PET-7017	ET-7217 PET-7217	8	±150 mV, ±500 mV, ±1 V, ±5 V, ±10 V, ±20 mA, 0 ~ 20 mA, 4 ~ 20 mA	-	4	Open Collector	Sink
ET-7017-10 PET-7017-10	ET-7217-10 PET-7217-10	10/20		-	-	-	-
ET-7018Z PET-7018Z	ET-7218Z PET-7218Z	10	±15 mV, ±50 mV, ±100 mV, ±500 mV, ±1 V, ±2.5 V, ±20 mA, 0 ~ 20 mA, 4 ~ 20 mA	Thermocouple: J, K, T, E, R, S, B, N, C, L, M, and LDIN43710	6/3 (Note 2)	Open Collector	Sink
ET-7019 PET-7019	-	8	±15 mV, ±50 mV, ±100 mV, ±150 mV, ±500 mV, ±1 V, ±5 V, ±10 V, ±20 mA, 0 ~ 20 mA, 4 ~ 20 mA	Thermocouple: J, K, T, E, R, S, B, N, C, L, M, and LDIN43710	4	Open Collector	Sink
ET-7019Z PET-7019Z	ET-7219Z PET-7219Z	10			6/3 (Note 2)		

**Note 1:** We recommend to choose ET-7018Z/PET-7018Z and ET-7019Z/PET-7019Z for extremely accurate thermocouple measurement.  
**Note 2:** 6 DO channels for ET-7018Z, PET-7018Z, ET-7019Z and PET-7019Z.  
3 DO channels for ET-7218Z, PET-7218Z, ET-7219Z and PET-7219Z.



**Multi-function I/O**



Model Name		AI			AO		DI/Counter		DO	
		Channel	Voltage and Current Input	Sensor Input	Channel	Voltage and Current Output	Channel	Contact	Channel	Type
ET-7002 PET-7002	ET-7202 PET-7202	3	±150 mV, ±500 mV, ±1 V, ±5 V, ±10 V, 0 ~ 20 mA, ±20 mA, 4 ~ 20 mA	-	-	-	6	Wet (Sink, Source)	3	Power Relay (Form A)
-	ET-7204 PET-7204	4		-	4	0 ~ 5 V, ±5 V, 0 ~ 10 V, ±10 V, 0 ~ 20 mA, 4 ~ 20 mA	4	Dry (Source), Wet (Sink, Source)	-	-
ET-7016 PET-7016	-	2	±15 mV, ±50 mV, ±100 mV, ±500 mV, ±1 V, ±2.5 V, 0 ~ 20 mA, ±20 mA, 4 ~ 20 mA	Strain Gauge, Load Cell, Full-Bridge, Half-Bridge, Quarter-Bridge	1 (Note)	0 ~ 10 V	2	Wet (Sink, Source)	2	Open Collector (Sink)
ET-7024 PET-7024	ET-7224 PET-7224	-	-	-	4	0 ~ 5 V, ±5 V, 0 ~ 10 V, ±10 V, 0 ~ 20 mA, 4 ~ 20 mA	5	Dry (Source), Wet (Sink, Source)	5	Open Collector (Sink)
ET-7026 PET-7026	ET-7226 PET-7226	6	±150 mV, ±500 mV, ±1 V, ±5 V, ±10 V, 0 ~ 20 mA, ±20 mA, 4 ~ 20 mA	-	2		2	Wet (Sink, Source)	2	
ET-7028 PET-7028	ET-7228 PET-7228	-	-	-	8		-	-	-	-

**Note:** The AO is configured as a voltage excitation source for the strain gauge.



Digital I/O



Model Name		DI/Counter			DO			
		Channel	Contact	Sink/Source	Channel	Type	Sink/Source	Max. Load Current @ 25°C
ET-7042 PET-7042	ET-7242 PET-7242	-	-	-	16	Open Collector	Sink	100 mA/channel
ET-7044 PET-7044	ET-7244 PET-7244	8	Wet	Sink, Source	8	Open Collector	Sink	300 mA/channel
ET-7050 PET-7050	ET-7250A PET-7250A	12	Wet (Note)	Sink, Source	6	Open Collector	Sink	100 mA/channel
ET-7051 PET-7051	ET-7251 PET-7251	16	Wet	Sink, Source	-	-	-	-
ET-7052 PET-7052	ET-7252 PET-7252	8	Wet	Sink, Source	8	Open Collector	Source	650 mA/channel
ET-7053 PET-7053	ET-7253 PET-7253	16	Dry	Source	-	-	-	-
-	ET-7255 PET-7255	8	Dry, Wet	Sink, Source	8	Open Collector	Source	650 mA/channel

Note: The ET-7250A/PET-7250A provides 12 channels digital input for both Dry and Wet contact.

AC/DC Digital Input



Model Name		AC Digital Input					
		Channels	ON Voltage Level	OFF Voltage Level	Max. Input Voltage	Operating AC Frequency	Isolation Voltage
-	ET-7258 PET-7258	8 Differential	80 ~ 250 VAC 90 ~ 250 VDC	< 30 VAC/VDC	250 VAC/VDC	50/60 Hz	2500 VDC
-	ET-7259 PET-7259		10 ~ 80 VAC 15 ~ 80 VDC	< 3 VAC/VDC	80 VAC/VDC		

Relay Output & Digital Input



Model Name		Relay Output				DI/Counter		
		Channel	Relay	Type	Max. Load Current @ 25°C	Channel	Contact	Sink/Source
ET-7060 PET-7060	ET-7260 PET-7260	6	Power Relay	Form A (SPST N.O.)	5.0 A/channel	6	Wet	Sink, Source
-	ET-7261 PET-7261	11	Power Relay	Form A (SPST N.O.)	5.0 A/channel	-	-	-
ET-7065 PET-7065	-	6	PhotoMOS Relay	Form A	1.0 A/channel	6	Wet	Sink, Source
ET-7066 PET-7066	-	8	PhotoMOS Relay	Form A	1.0 A/channel	-	-	-
ET-7067 PET-7067	ET-7267 PET-7267	8	Power Relay	Form A (SPST N.O.)	5.0 A/channel	-	-	-

Encoder/Counter Input



Model Name		Encoder/Frequency/Counter Input						DO	
		Channel	Encoder	Counter	Frequency	Count Value Retention	Maximum counting rate	Channel	Type
ET-7083 PET-7083	-	3	CW/CCW, Dir/Pulse,	-	-	Yes, up to 10 years	1 MHz	-	-
-	ET-7284 PET-7284	4/8	AB Phase	Up or Up/ Down	Yes		200 kHz	4	Open Collector

## 2.2 High Speed Data Logger – ET-7H16

The ET-7H16 is a high speed analog input with single-ended analog inputs (200 KHz sample and hold for 8 channels), 4-channel digital inputs and 4-channel digital outputs. It provides programmable input range on all analog channels ( $\pm 5\text{ V}$  and  $\pm 10\text{ V}$ ), digital output can be set output with Short-circuit protection and overload protection. ET-7H16 also has qualification for 4 kV ESD protection as well as 3000 VDC intra-module isolation.



	Continuous Mode	30,000,000 Records
Software AD	1 ~ 25 KHz	25 KHz ~ 200 KHz 157 sec (25 KHz), 19.6 sec (200 KHz)
External CLK AD	1 ~ 25 KHz	-
Post-Trigger	-	1 Hz ~ 200 KHz
Pre-Trigger	-	1 Hz ~ 200 KHz

### Features:

#### 1 Software AD Data Acquisition

1. Support continuous data transferring to client side of data acquisition application to maximum 25 KHz/Ch sample rate.
2. 25 KHz/Ch ~ 200 KHz/Ch sample rate application, support maximum 30,000,000 records (157 sec for 25 KHz, 19.6 sec for 200 KHz), data sampled then transfer to client side via command.

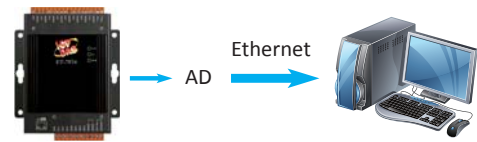

#### 2 External Clock AD Convert Data Acquisition

1. Support maximum 25 KHz/Ch external clock to convert AD and transfer data via Ethernet Port to client side.
2. Can use external clock to convert AD signal for many ET-7H16 AD at synchronized speed.

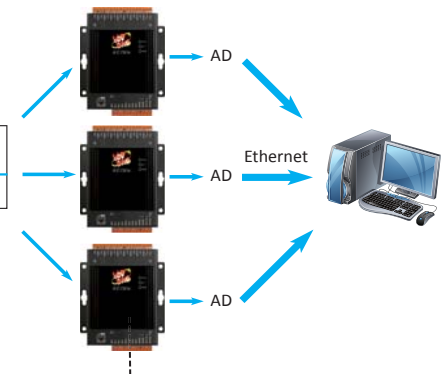
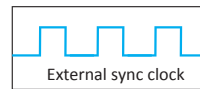

#### 3 External Digital Event Trigger Data Acquisition

1. Can support Maximum 200 KHz/Ch sample rate
2. Maximum 30,000,000 records
3. Data sampled then transfer to client side via command

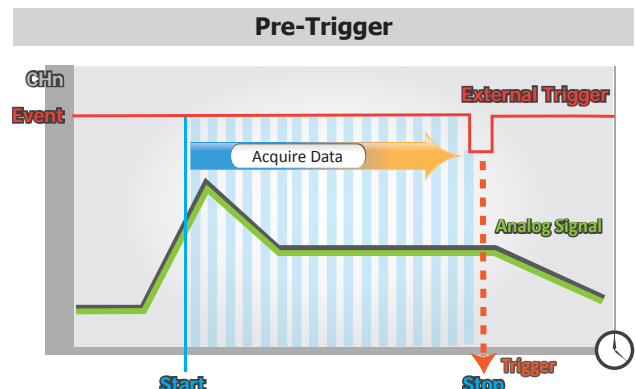
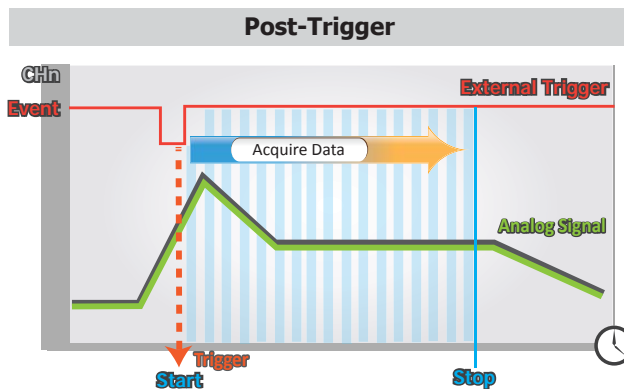

### Analog Input Model

Module Name	Analog Input			Digital Input			Digital Output		
	Channel	Sampling Rate	Bipolar Input	Channel	Contact	Sink/Source	Channel	Type	Sink/Source
ET-7H16	8, Single-ended	200 KS/s	$\pm 10\text{ V}$ , $\pm 5\text{ V}$	4	Wet	Sink, Source	4	Open Collector	Sink

## 2.3 Tiny-Size Modbus TCP I/O Modules

### Introduction:



The functionality of the tET/tPET series modules is almost the same as the PET-7000. The major difference is that the PET-7000 module supports user-defined web HMI interface and more connections, while the tET/tPET series supports fixed web interface for configuration, higher speed of 32-bit DI counters, frequency measurement, PWM digital output and low power consumption. Especially the tET/tPET series features tiny form factor and low channel count that are suitable in distributed I/O points applications, such as room control and monitor.

Push mode is a new way to transfer local DI status, immediately and automatically, to remote device or computer once the DI status changes. Without busy polling, push mode effectively reduces the network loading and improves the performance of the whole system. tET/tPET series supports both polling and push mode to transfer the I/O data over the network. No programming is required in the tET/tPET series, and the push mode can be easily enabled through the web configuration interface. The solution makes the user set up system easily and quickly, and the system work more efficient.

Push mode is a new way to transfer local DI status, immediately and automatically, to remote device or computer once the DI status changes. Without busy polling, push mode effectively reduces the network loading and improves the performance of the whole system. tET/tPET series supports both polling and push mode to transfer the I/O data over the network. No programming is required in the tET/tPET series, and the push mode can be easily enabled through the web configuration interface. The solution makes the user set up system easily and quickly, and the system work more efficient.

### Application:

- Remote Maintenance
- Testing Equipment
- Building Automation
- Factory Automation
- Machine Automation

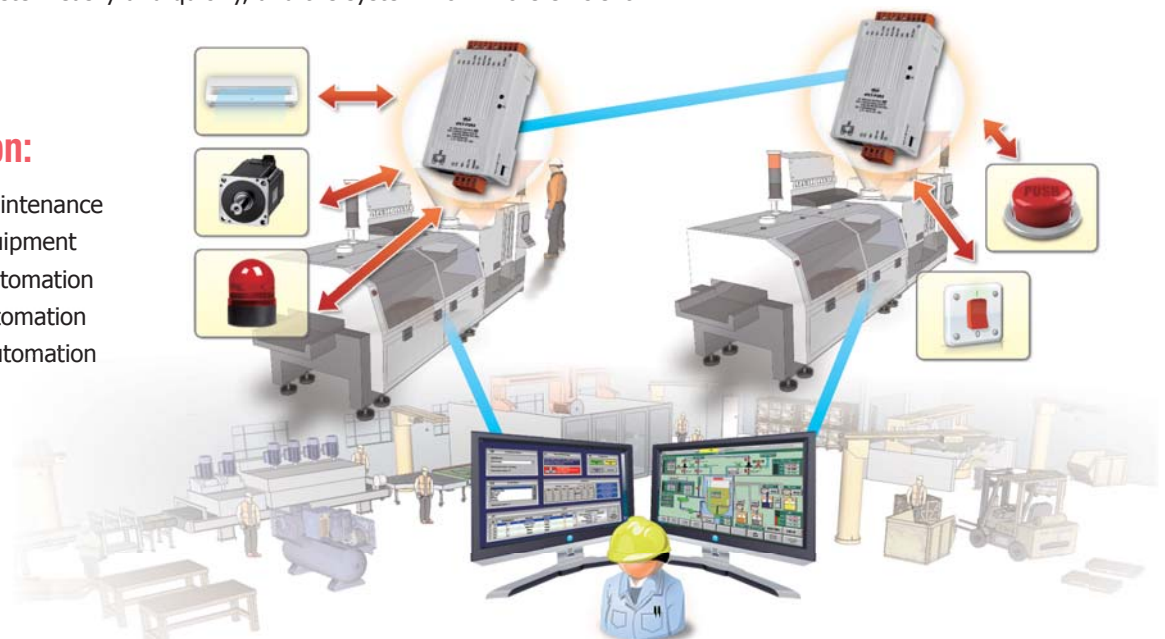

### Features:

#### ① DIO Pair-Connection (Mirror)

The tET/tPET series Ethernet I/O modules support various I/O types, like photo-isolated digital input, power relay, PhotoMOS relay, and open collector output. The module can be used to create DI to DO pair-connection (mirror) through the Ethernet. Once the configuration is completed, the modules can automatically read the local DI status and write to remote DO channels via the Modbus TCP protocol in the background.

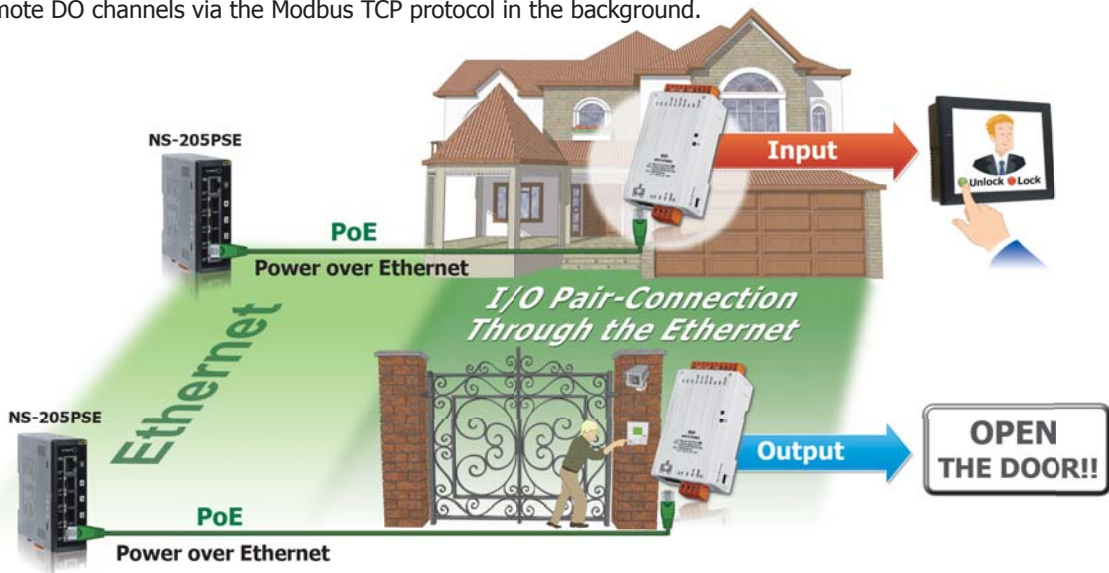



## 2 32-bit High Speed Digital Counter

Polling the remote DI status back and then counting the ON/OFF changes in host computer may get quantity errors caused by communication delay. The tET/tPET series module has Built-in 32-bit counter function; it counts the DI ON/OFF changes in site to prevent counting errors caused by the communication latency. The 32-bit counter of the tET/tPET modules can count up to 4,294,967,295 and accept a frequency up to 3,500 Hz (without low pass filter), so it is suitable for more applications such as production counting, button or switch ON/OFF counting, event counting.

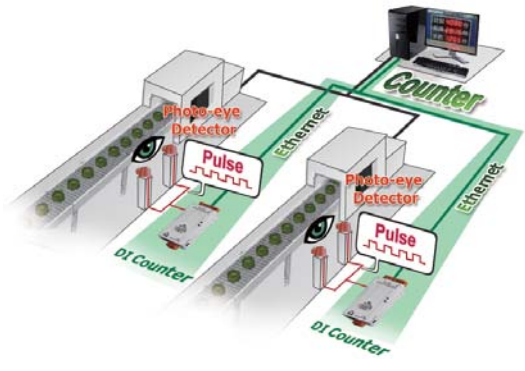

## 3 Frequency Measurement

The tET/tPET module also supports frequency measurement function; it counts the DI ON/OFF changes in a certain time period and then calculates the frequency automatically. Rather than polling remote DI status back and then computing the frequency in the host PC, our module can directly count out the frequency in site. This reduces the frequency errors caused by communication latency between two ends, and also reduces the network loadings. In order to apply for more applications, this module provides 3 scan modes (0.1s, 1s and single-pulse) and 4 moving average levels for user to select the best way in their applications. This feature can be used for rotation and speed measurements... etc.

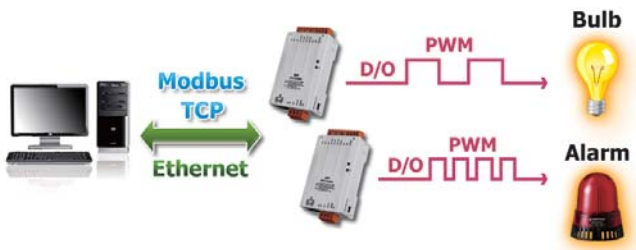

## 4 PWM (Pulse Width Modulation) Digital Output

The DOs on the tET/tPET series provide PWM (pulse width modulation) function that can be used in applications such as alarm light, flash light controls. Once the configuration is finished, the module will automatically and continuously switch the DO output ON and OFF. This removes the busy control by remote host and also reduces the network loadings. Users can set different frequency and duty cycle for the PWM function in each digital output channel. In addition, the DO channels can work independently or simultaneously. This function reduces the complexity of the control system and enhances the timing accuracy of pulse output.

## 5 Easy Network Configuration

DHCP minimizes configuration errors caused by manual IP address configuration, such as address conflicts caused by the assignment of an IP address to more than one computer or device at the same time. The tET/tPET series module supports the DHCP client function, which allows the tET/tPET to easily obtain the necessary TCP/IP configuration information from a DHCP server. The module also contains a UDP responder that transmits its IP address information to a UDP search from the eSearch utility program, making local management more efficient. The series of Ethernet I/O modules features a powerful 32-bit MCU to enable efficient handling of network traffic. It also has a Built-in web server that provides an intuitive web management interface to allow users to modify the settings of the module including DHCP/Static IP, gateway and mask.

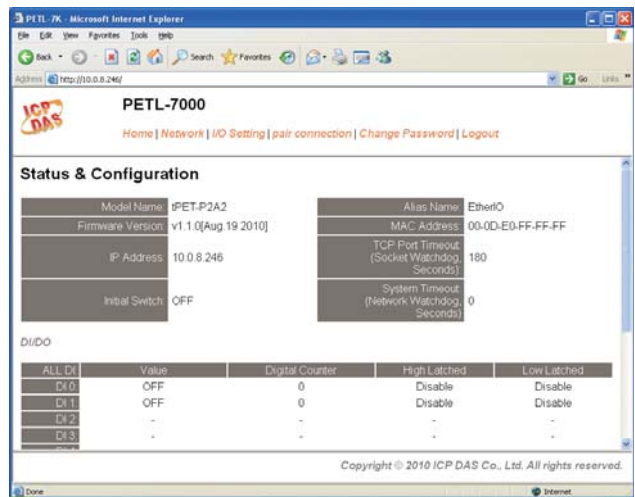

## 6 Dual Watchdog with Power-on and Safe Value

The module provides dual watchdog: module watchdog (hardware function) and host watchdog (software function). The module watchdog automatically resets the module if the built-in firmware is operating abnormally, while the host watchdog sets the digital output with predefined safe-value when there is no communication between the module and the host (PC or PLC) for a period of time (watchdog timeout). The dual watchdog is an important feature that ensures the module operates continuously, even in harsh environments.

## 7 PoE (Power over Ethernet)

The module also accept power input from a DC adapter.

## 8 Low Power Consumption



**1 Polling: Masters poll tET/tPET DIO modules**

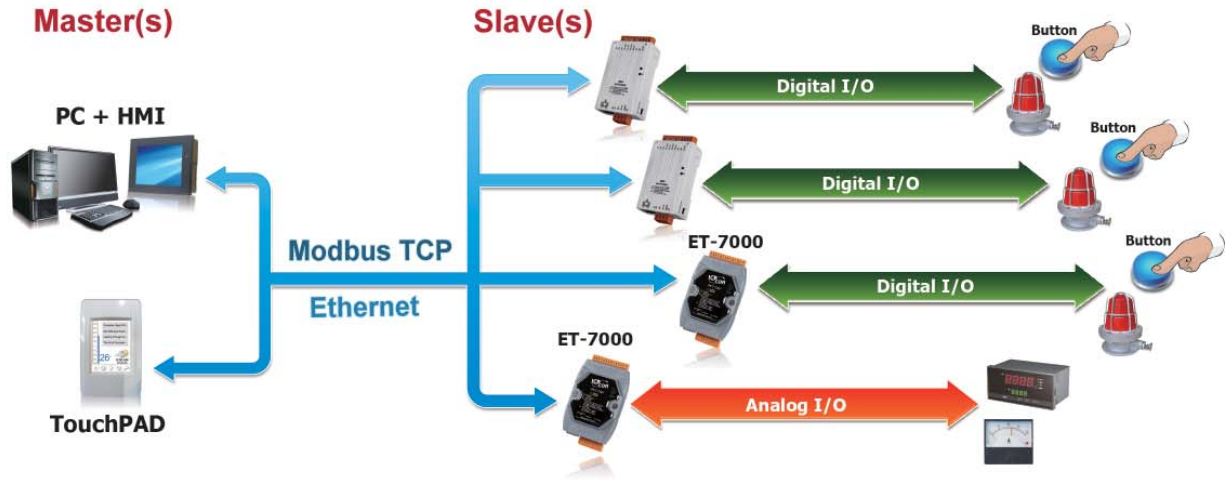

**2 Push: tET/tPET module pushes DI to remote DO**

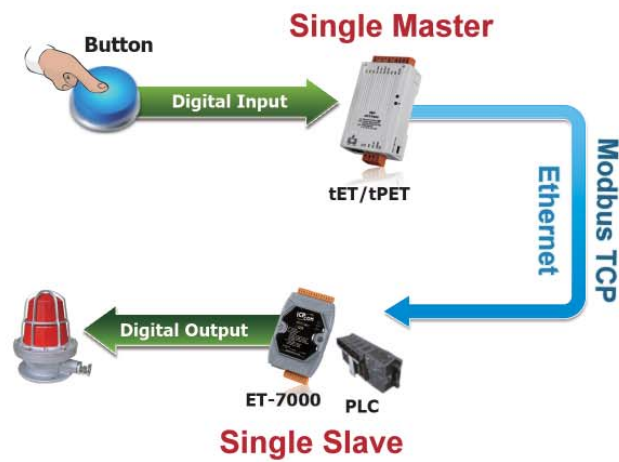

**3 Push: tET/tPET modules push DI to remote DO**

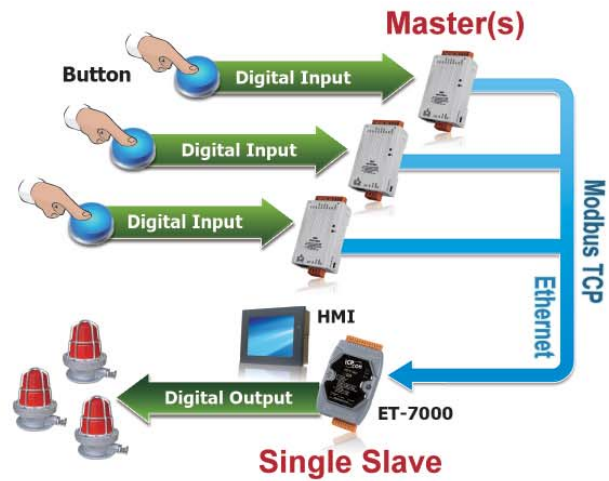

**4 Polling: tET/tPET DIO pair-connection**



**5 Polling: tET/tPET modules poll remote DIO**

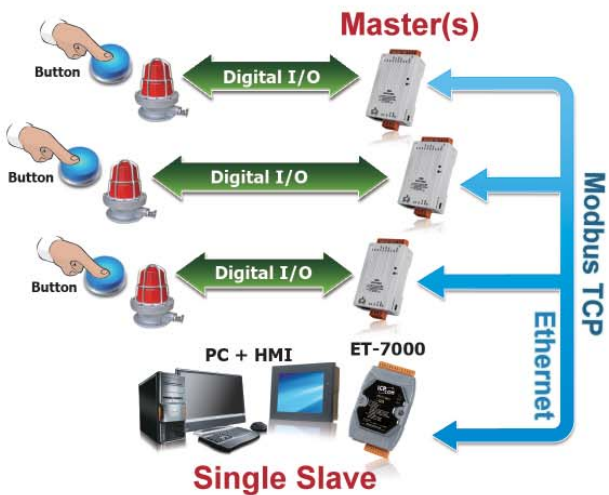

## System Specifications:

Model Name	tET Series	tPET Series
<b>Software</b>		
Built-in Web Server	Yes	
I/O Pair Connection	Yes, Supports Polling and Push modes	
<b>Communication</b>		
Ethernet Port	10/100 Base-TX, 8-Pin RJ-45 x1 (Auto-negotiating, Auto-MDI/MDIX, LED indicators)	
Protocol	Modbus TCP, Modbus UDP, HTTP, DHCP, BOOTP and TFTP	
Security	IP filter (whitelist) and Password (web)	
Dual Watchdog	Yes, Module (2 seconds) and Host (programmable)	
<b>LED Indicators</b>		
S1	System Running (Red)	PoE (Green)
E1	Link/Act (Green), 10/100 M (Yellow)	
<b>EMS Protection</b>		
ESD (IEC 61000-4-2)	±4 kV Contact for Each Terminal	
EFT (IEC 61000-4-4)	±2 kV for Power and Signal	
<b>Mechanical</b>		
Dimensions (W × L × H)	52 mm × 98 mm × 27 mm	
Installation	DIN-Rail	
<b>Power Requirements</b>		
Powered from Terminal Block	Yes, +12 ~ 48 VDC (non-regulated)	
Powered from PoE	-	Yes, IEEE 802.3af, Class 1
Consumption	0.04 A @ 24 VDC Max. for tET-P2R2	0.03 A @ 48 VDC Max. for tPET-P2R2
<b>Environment</b>		
Operating Temperature	-25 ~ +75°C	
Storage Temperature	-30 ~ +80°C	
Humidity	10 ~ 90% RH, Non-condensing	

## Selection Guide:

Digital I/O							
Model Name		DI			DO		
Ethernet	PoE	Channel	Contact	Sink/Source	Channel	Type	Sink/Source
tET-P6	tPET-P6	6	Wet	Sink/Source	-	-	-
tET-PD6	tPET-PD6	6	Dry	Source	-	-	-
tET-C4	tPET-C4	-	-	-	4	Open Collector	Sink/NPN
tET-A4	tPET-A4	-	-	-	4	Open Emitter	Source/PNP
tET-P2C2	tPET-P2C2	2	Wet	Sink/Source	2	Open Collector	Sink/NPN
tET-P2A2	tPET-P2A2	2	Wet	Sink/Source	2	Open Emitter	Source/PNP

Relay Output/Digital Input								
Model Name		Relay Output				DI		
Ethernet	PoE	Channel	Relay	Type	Max. Load Current	Channel	Contact	Sink/Source
tET-P2POR2	tPET-P2POR2	2	PhotoMOS Relay	Form A	1.0 A/channel	2	Wet	Sink/Source
tET-PD2POR2	tPET-PD2POR2	2	PhotoMOS Relay	Form A	1.0 A/channel	2	Dry	Source
tET-P2R2	tPET-P2R2	2	Power Relay	Form A (SPST N.O.)	5.0 A/channel	2	Wet	Sink/Source
tET-PD2R1	tPET-PD2R1	1	Power Relay	Form A (SPST N.O.)	5.0 A/channel	2	Dry	Source



## 2.4 Slim-Type Modbus TCP I/O Modules

### Introduction:



The ET-2200 module has built-in **2-port Ethernet Switch with LAN-bypass function**, which allows daisy-chain Ethernet cabling easily and reduces the total cost since less external Ethernet Switches installed. The ET-2200 module also provides **web configuration, higher speed of 32-bit DI counters, frequency measurement, PWM digital output functions**.

Push mode is a new way to transfer local DI status, immediately and automatically, to remote device or computer once the DI status changes. Without busy polling, push mode effectively reduces the network loading and improves the performance of the whole system. The ET-2200 module supports both **polling and push mode** to transfer the I/O data over the network. No programming is required in the ET-2200 module, and the push mode can be easily enabled through the web configuration interface.

### Selection Guide:

Model Name	AI		
	Channel	Voltage and Current Input	Sensor Input
ET-2215	7	-	RTD: Pt100, Pt1000, Ni120, Cu100, Cu1000
ET-2217	8	±150 mV, ±500 mV, ±1 V, ±5 V, ±10 V, ±20 mA, 0 ~ 20 mA, 4 ~ 20 mA	-
ET-2218	10	±15 mV, ±50 mV, ±100 mV, ±500 mV, ±1 V, ±2.5 V, ±20 mA, 0 ~ 20 mA, 4 ~ 20 mA	Thermocouple: J, K, T, E, R, S, B, N, C, L, M, and LDIN43710
ET-2219	8	±15 mV, ±50 mV, ±100 mV, ±150 mV, ±500 mV, ±1 V, ±5 V, ±10 V ±20 mA, 0 ~ 20 mA, 4 ~ 20 mA	Thermocouple: J, K, T, E, R, S, B, N, C, L, M, and LDIN43710

Model Name	AI		AO		DI/Counter		DO	
	Channel	Voltage and Current Input	Channel	Voltage and Current Output	Channel	Contact	Channel	Type
ET-2202	5	±150 mV, ±500 mV, ±1 V, ±5 V, ±10 V, 0 ~ 20 mA, ±20 mA, 4 ~ 20 mA	-	-	5	Wet (Sink, Source)	5	Power Relay (Form A)
ET-2224	-	-	4	0 ~ 5 V, ±5 V, 0 ~ 10 V, ±10 V, 0 ~ 20 mA, ±20 mA, 4 ~ 20 mA	-	Dry (Source),	-	Open Collector (Sink)
ET-2226	8	±150 mV, ±500 mV, ±1 V, ±5 V, ±10 V, 0 ~ 20 mA, ±20 mA, 4 ~ 20 mA	2		2	Wet (Sink, Source)	2	
ET-2228	-	-	8		-	-	-	

Model Name	UDIO	DI			DO			
	Channels	Channels	Contact	Sink/Source	Channels	Type	Sink/Source	Max. Load @ 25°C
ET-2242	-	-	-	-	16	Open Collector	Sink	650 mA/Channel
ET-2242U	-	-	-	-	16	Push-Pull	Sink, Source	500 mA/Channel
ET-2251	-	16	Wet/Dry	Sink/Source	-	-	-	-
ET-2251-32	-	32	Wet/Dry	Sink/Source	-	-	-	-
ET-2254	16	(Note)	Dry	Source	(Note)	Open Collector	Sink	100 mA/Channel
ET-2254P	16	(Note)	Dry	Source	(Note)	Open Collector	Sink	350 mA/Channel
ET-2255	-	8	Wet/Dry	Sink/Source	8	Open Collector	Sink	650 mA/Channel
ET-2255U	-	8	Wet/Dry	Sink/Source	8	Push-Pull	Sink, Source	500 mA/Channel
ET-2255U-32	-	16	Wet/Dry	Sink/Source	16	Push-Pull	Sink, Source	500 mA/Channel

Note: The number of DI/DO channels is depending on wiring and the software configuration.

Model Name	DI			Relay			
	Channels	Contact	Sink/Source	Channels	Relay	Type	Contact Rating
ET-2260	6	Wet	Sink/Source	6	Power Relay	Form A (SPST N.O.)	5 A @ 250 VAC/24 VDC (Resistive Load)
ET-2261	-	-	-	10	Power Relay	Form A (SPST N.O.)	5 A @ 250 VAC/24 VDC (Resistive Load)
ET-2268	-	-	-	8	Signal Relay	4 Form A, 4 Form C	2 A @ 30 VDC 0.25 A @ 250 VDC

## 2.5 EtherNet/IP I/O Modules

### Introduction:



The EIP-2000 is an industrial remote I/O module series supporting the EtherNet/IP protocol. Users can seamlessly integrate these modules into the Ethernet network from the industrial floor to the enterprise. The EIP-2000 allows daisy chain connection which permits the flexibility in locating devices, eases installation and lowers infrastructure costs. All the modules can be deployed in the network topologies such as star, line or ring. The isolation design protects the EIP-2000 against the harmful interference.

### Selection Guide:

Digital Input & Output Module				
Model Name	EIP-2042	EIP-2051	EIP-2055	EIP-2060
<b>Digital Input</b>				
Channels		16	8	6
Contact			Dry + Wet	
Sink/Source (NPN/PNP)			Sink/Source	
Wet Contact	On Voltage Level		+10 ~ 50 VDC	
	Off Voltage Level		+4 VDC Max.	
Dry Contact	On Voltage Level		Close to GND	
	Off Voltage Level		Open	
Input Impedance			10 k $\Omega$ , 0.5W	
<b>Digital Output</b>				
Channels	16		8	6
Type	Open Collector		Open Collector	Power Relay
Sink/Source (NPN/PNP)	Sink (NPN)		Sink (NPN)	Form A
Load Voltage	+3.5 ~ +50 VDC		+3.5 ~ +50 VDC	30 VDC/125 VAC
Max. Load Current	700 mA/Channel	-	700 mA/Channel	5 A @ 30 VDC 5 A @ 125 VAC
Overvoltage Protection	60 VDC		60 VDC	-
Overload Protection	Yes		Yes	-
Power-on Value	Yes		Yes	Yes
Safe Value	Yes		Yes	Yes

Analog Input Module				
Model Name		EIP-2017	EIP-2019	
Channels	Differential	8	8	
	Single-Ended	16	-	
Sensor Type		-	Thermocouple (B,C,E,J,K,N,R,S,T)	
Voltage Input Range		$\pm 150$ mV, $\pm 500$ mV, $\pm 1$ V, $\pm 5$ V, $\pm 10$ V	$\pm 15$ mV, $\pm 50$ mV, $\pm 100$ mV, $\pm 150$ mV, $\pm 500$ mV, $\pm 1$ V, $\pm 2.5$ V, $\pm 5$ V, $\pm 10$ V	
Current Input Range		$\pm 20$ mA, 0 ~ +20 mA, +4 mA ~ +20 mA (Jumper Selectable)	$\pm 20$ mA, 0 ~ +20 mA, +4 mA ~ +20 mA (Jumper Selectable)	
Resolution		16-bit		
Sampling Rate		10Hz		
Accuracy		$\pm 0.1\%$ of FSR		

## 2.6 EtherCAT Products

### Introduction:



EtherCAT (Ethernet for Control Automation Technology) is an open, high-performance fieldbus system that makes Ethernet technologies available at the I/O level. EtherCAT provides flexible wiring, fast communication and many other nice features. It needs a master to control many slaves. ICP DAS provides PC master cards, ECAT-8000 and ECAT-8001, for users to build their applications including motion control. These cards can offer multi-axis motion and I/O control functions by their own built-in CPU. In this way, the CPU loading of PC can be reduced dramatically. In the mean while, ICP DAS also provides many I/O slave modules for users to choose from. Since EtherCAT technology is an industrial standard, those modules can work together in a system with 3rd-party EtherCAT slaves as well.

### Selection Guide:

Model Name	Encoder Module	
ECAT-2092	2 axis	1. A/B phase 2. CW/CCW 3. Pulse/Dir.
ECAT-2092T	2 axis	
ECAT-2093	3 axis	

Model Name	Stepping Motor Driving Module	
ECAT-2091S	1 axis	2-phase stepper motor
ECAT-2094S	4 axis	
ECAT-2098S	8 axis	

Model Name	Analog Input Module	
ECAT-2015	7 channels	Thermistor inputs
ECAT-2017	8/16 channels	Analog signal inputs
ECAT-2018	8 channels	Thermocouple inputs



Model Name	Analog Output Module	
ECAT-2024	4 channels	
ECAT-2028	8 channels	

Model Name	Digital I/O Module	
	Digital Input Channels	Digital Output Channels
ECAT-2057	-	16
ECAT-2057-PNP	-	16
ECAT-2057-8P8N	-	8
ECAT-2045	-	16
ECAT-2045-32	-	32
ECAT-2051	16	-
ECAT-2051-32	32	-
ECAT-2050	14	4
ECAT-2052	8	8
ECAT-2052-NPN	16	8
ECAT-2053	8	-
ECAT-2055	16	8
ECAT-2055-32	6	16
ECAT-2060	10	6
ECAT-2060-20	10	10
ECAT-2061	-	16

More information, refer to chapter 7.2 (page 7-6)



## 2.7 BACnet/IP I/O Modules

Model Name	BNET-5304	BNET-5310
Pictures	Multi-function BACnet/IP Module 	Multi-function BACnet/IP Module 
<b>System</b>		
COM1	Reserved	
Ethernet	10/100 Base-TX	
Security	ID and Password	
Built-in Watchdog	Yes	
LED Indicator	Power and Status	
<b>Protocol</b>		
BACnet	BACnet/IP	
BACnet Objects	1 Device, 6 AI, 1 AO, 4 BI, 4 BO	1 Device, 4 AI, 2 AO, 3 BI, 3 BO
BIBB	DS-RP-B, DS-RPM-B, DS-WP-B, DS-WPM-B, DS-COV-B, DM-DDB-B, DM-DOB-B, DM-DCC-B, DM-TS-B, DM-UTC-B, DM-RD-B	
<b>Analog Input</b>		
Channel	6	4
Wiring	Single-Ended	Differential
Range	±5 V, 0 ~ +5 V	±10 V
Resolution	12-bit	
Sampling Rate	4 KHz	
Input Impedance	1 MΩ	
Overvoltage Protection	±30 VDC	
Isolation	Non-isolated	
<b>Analog Output</b>		
Channel	1	2
Range	±5 V	±10 V
Resolution	12-bit	
Output Capacity	20 mA	
Isolation	Non-isolated	
<b>Digital Input</b>		
Channels	4	3
Contact	Dry	
Dry Contact	On Voltage Level	Close to GND
	Off Voltage Level	Open
Overvoltage Protection	30 VDC	
<b>Digital Output</b>		
Channels	4	3
Type	Open Collector	
Sink/Source (NPN/PNP)	Sink	
Load Voltage	+10 VDC ~ 40 VDC	
Max. Load Current	200 mA/channel at 25°C	
Overload Protection	1.4 A	
<b>Environmental</b>		
Dimensions (W × L × H)	91 mm × 132 mm × 52 mm	
Operating Temp	-25 ~ +75°C	
Storage Temp.	-30 ~ +85°C	
Humidity	5 ~ 90% PH, Non-condensing	
Power Input Range	+10 V to +30 VDC	
Power Consumption	4.8 W (0.2 A @ 24 VDC)	

# 2.8 PROFINET Products

## Introduction:

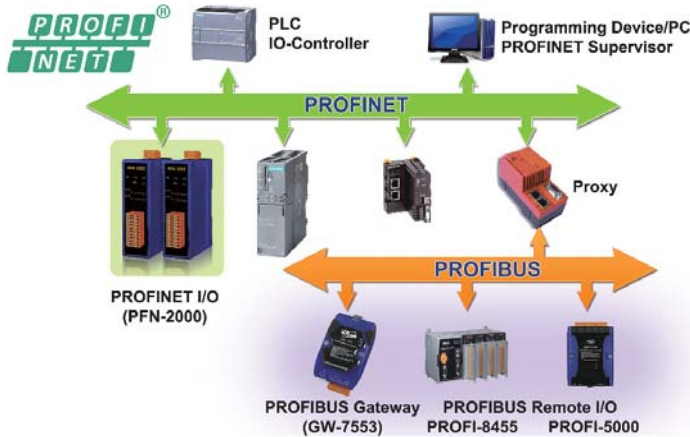

PROFINET is the Ethernet based standard for real-time automation that specified and published by PI (PROFIBUS & PROFINET International – <http://www.profibus.com>). PROFINET uses Ethernet standard as well as TCP, UDP and IP as protocols for communication, configuration and diagnosis in the network. Therefore, it is easy to be integrated to existing fieldbus systems, like PROFIBUS DP, PROFIBUS PA, Interbus, DeviceNet and other technologies to an open Ethernet based network without changes to existing field devices.

The PROFINET standard defines three different performance levels which cover the various requirements from different applications.

**PROFINET NRT (Non Real Time):** It uses standard protocols as UDP/IP. With response time approx. 100 ms PROFINET NRT targets for applications in process automation.

**PROFINET RT (Real Time):** For applications with higher requirements on cycle time like factory automation, it directly uses the Ethernet protocol to exchange I/O data, while diagnosis and configuration uses standard UDP/IP. PROFINET RT enables applications With response time approx. > 10 ms.

**PROFINET IRT (Isochronous Real Time):** The highest requirements come from the control of complex industrial drive systems, like packaging machines or robotics. With applications with cycle time < 1 ms and jitter < 1 μs are possible.

The PFN-2000 series provides various I/O modules that meet PROFINET RT for process automation, factory automation.

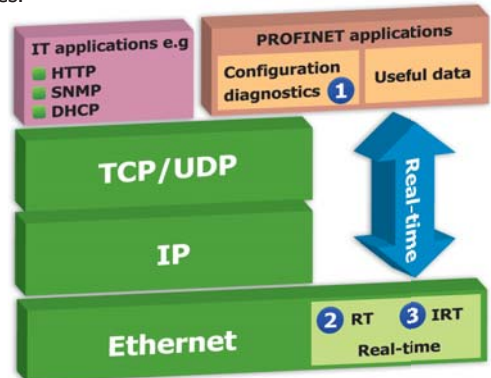

### 1 TCP/IP

- Device parameterization and configuring
- Reading of diagnostic data
- Negotiating the useful data channel

### 2 Real-time RT

- Effective cyclic transmission of useful data
- Event-driven messages/alarms

### 3 Isochronous real-time IRT

- Useful data transfer in isochronous mode
- Hardware support through ERTEC
- Jitter < 1 μs

## Features:

- Transfer protocol: PROFINET I/O
- 10/100 Base-TX Ethernet, RJ-45 × 2
- PROFINET Conformance Class B and RT Class 1
- Cyclic Time: 1 ms (min)
- Generic GSDML (V 2.25) File Provided
- Supported Ethernet services: ICMP, IGMP, ARP, DHCP, TELNET, TFTP, SNMP, VLAN Priority Tagging
- Supported PROFINET services: RTC, RTA, CL-RPC, DCP, LLDP, I & M

## Dimensions (Units: mm):

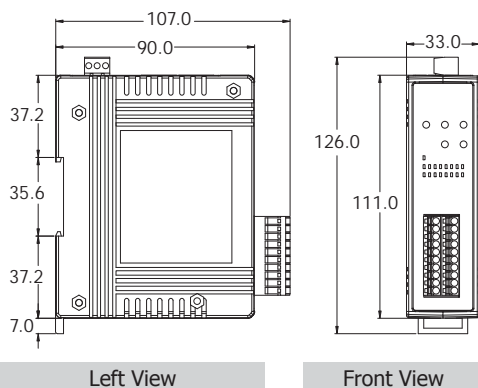

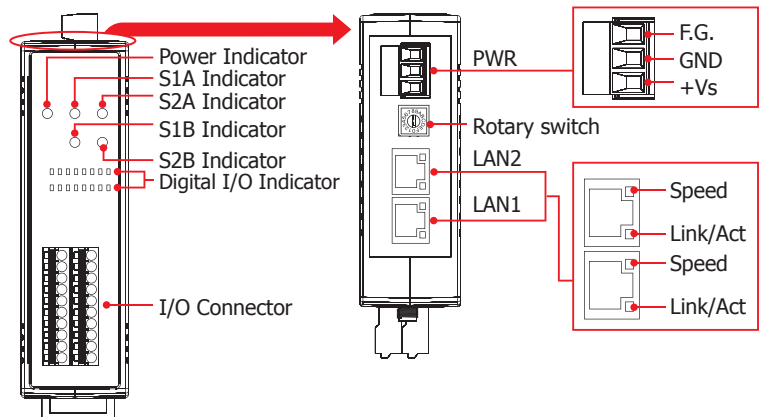

## Appearance:









## Selection Guide:

Model Name	Description
	<b>PFN-2019</b> PROFINET I/O Module with 10-Ch universal AI
	<b>PFN-2024</b> PROFINET I/O Module with 4-Ch AO
	<b>PFN-2042</b> PROFINET I/O Module with 16-Ch DO
	<b>PFN-2051</b> PROFINET I/O Module with 16-Ch DI
	<b>PFN-2052</b> PROFINET I/O Module with 8-Ch DI
	<b>PFN-2053</b> PROFINET I/O Module with 16-Ch DI
	<b>PFN-2055</b> PROFINET I/O Module with 8-Ch DI, 8-Ch DO
	<b>PFN-2060</b> PROFINET I/O Module with 6-Ch DI, 6-Ch Relay

Analog Module	
Model Name	PFN-2019
Pictures	10-Ch AI Module 
Analog Input	
Channels	10 (Differential)
Sensor Type	Thermocouple (J, K, T, E, R, S, B, N, C)
Voltage Input Range	±15 mV, ±50 mV, ±100 mV, ±500 mV, ±1 V, ±2.5 V, ±5 V, ±10 V
Current Input Range	±20 mA, 0 ~ +20 mA, +4 mA ~ +20 mA (Jumper Selectable)
Resolution	16-bit
Sampling Rate	10 Hz
Accuracy	±0.1% of FSR
EDS Protection	4 kV Contact for each channel

Analog Module		
Model Name	PFN-2024	
Pictures	4-Ch AO Module 	
Analog Output		
Channels	4	
Voltage Output Range	0 ~ 5 V, ±5 V, 0 ~ 10 V, ±10 V	
Current Output Range	0 ~ 20 mA, 4 ~ 20 mA	
Resolution	16-bit	
Accuracy	Voltage Output	±0.1% of FSR
	Current Output	±0.1% of FSR
ESD Protection	4 kV Contact for each channel	

## Digital Input & Output Modules

Digital Input & Output Module						
Model Name	PFN-2042	PFN-2051	PFN-2052	PFN-2053	PFN-2055	PFN-2060
Pictures	16-Ch DO Module 	16-Ch DI Module 	8-Ch DI Module 	16-Ch DI Module 	8-Ch DI, 8-Ch DO Module 	6-Ch DI, 6-Ch Relay Module 
Digital Input						
Channels		16	8	16	8	6
Contact		Dry + Wet	Wet	Dry	Dry + Wet	Dry + Wet
Sink/Source (NPN/PNP)		Sink/Source	Sink/Source	Source	Sink/Source	Sink/Source
Wet Contact	On Voltage Level	-	+10 ~ 50 VDC	+4 ~ 30 VDC	-	+10 ~ 50 VDC
	Off Voltage Level		+4 VDC Max.	+1 VDC Max.	-	+4 VDC Max.
Dry Contact	On Voltage Level	Close to GND	-	Close to GND	Close to GND	Close to GND
	Off Voltage Level	Open	-	Open	Open	Open
Input Impedance		10 kΩ, 0.5 W	3 kΩ, 0.3 W	-	10 kΩ, 0.5 W	10 kΩ, 0.5 W
Digital Output						
Channels	16				8	6
Type	Open Collector				Open Collector	Power Relay
Sink/Source (NPN/PNP)	Sink				Sink	Form A
Load Voltage	+3.5 ~ +50 VDC				+3.5 ~ +50 VDC	30 VDC/125 VAC
Max. Load Current	700 mA/Channel	-	-	-	700 mA/Channel	2 A @ 30 VDC, 0.6 A @ 125 VAC
Overvoltage Protection	60 VDC				60 VDC	-
Overload Protection	Yes				Yes	-
Power-on Value	Yes				Yes	Yes
Safe Value	Yes				Yes	Yes



# 3. PROFIBUS I/O Products



**PROFIBUS** (Process Field Bus) is a standard for fieldbus communication in automation technology and was first promoted (1989) by BMBF (German department of education and research). It is the world's most successful fieldbus, with more than 31 million devices installed by the end of 2009. Over 5.4 million of these were in the process industries.

There are two variations of PROFIBUS in use today. The most commonly used PROFIBUS DP, and the lesser used PROFIBUS PA.

➤ **PROFIBUS DP (Decentralized Peripherals)**

It is used to operate sensors and actuators via a centralized controller in production (factory) automation applications.

➤ **PROFIBUS PA (Process Automation)**



It is used to monitor measuring equipment via a process control system in process automation applications. This variant is designed for use in explosion/hazardous areas.

ICP DAS has been developing various PROFIBUS DP Slave products for several years. We offer converters, gateways, and remote I/O to our customers, and help them to solve technology problems.



## Features:

- Baudrate up to 12 Mbit/s
- Maximum 244 bytes input and 244 bytes output per slave
- Fast Cyclic data communication between master and slave
- Slave configuration and parameters are set from the master side by GSD file
- Allow Multi-master system
- 124 slaves can be put in Data Exchange
- 32 stations on one segment

## Selection Guide:

Model Name		Description
<b>Remote I/O Modules</b> 	<b>PROFI-5017</b>	PROFIBUS-DP I/O Module with 8-Ch Voltage Inputs
	<b>PROFI-5017C</b>	PROFIBUS-DP I/O Module with 8-Ch Current Inputs
	<b>PROFI-5018</b>	PROFIBUS-DP I/O Module with 10-Ch Thermocouple Inputs
	<b>PROFI-5024</b>	PROFIBUS-DP I/O Module with 4-Ch Voltage/Current Outputs
	<b>PROFI-5045</b>	PROFIBUS-DP I/O Module with 24-Ch DO
	<b>PROFI-5050</b>	PROFIBUS-DP I/O Module with 16-Ch DI, 8-Ch DO
	<b>PROFI-5051</b>	PROFIBUS-DP I/O Module with 24-Ch DI
	<b>PROFI-5052</b>	PROFIBUS-DP I/O Module with 12-Ch DI
	<b>PROFI-5053</b>	PROFIBUS-DP I/O Module with 24-Ch DI
	<b>PROFI-5055</b>	PROFIBUS-DP I/O Module with 8-Ch DI, 8-Ch DO
	<b>PROFI-5060</b>	PROFIBUS-DP I/O Module with 8-Ch DI, 4-Ch Relay
<b>Remote I/O units</b> 	<b>PROFI-8155</b>	PROFIBUS-DP I/O Unit with 1 I/O slot
	<b>PROFI-8255</b>	PROFIBUS-DP I/O Unit with 2 I/O slots
	<b>PROFI-8455</b>	PROFIBUS-DP I/O Unit with 4 I/O slots
	<b>PROFI-8855</b>	PROFIBUS-DP I/O Unit with 8 I/O slots
<b>Accessories</b> 	<b>CNT-PROFI</b>	PROFIBUS 9-pin D-Sub Male Connector

## 3.1 PROFIBUS Remote I/O Modules

PROFIBUS Analog Input Modules			
Model Name	PROFI-5017	PROFI-5017C	PROFI-5018
Pictures	8-Ch Voltage Input Module	8-Ch Current Input Module	10-Ch Thermocouple Input Module
			
Channels	8	8	10
Wiring	Differential	Differential	Differential
Individual Channel	Yes	Yes	Yes
Sensor Type	-	-	Thermocouple (J, K, T, E, R, S, B, N, C)
Voltage Input Range	±10 V ±5 V ±2.5 V ±1.25 V	-	±15 mV, ±50 mV, ±100 mV, ±500 mV, ±1 V, ±2.5 V, ±5 V, ±10 V
Current Input Range	-	0 ~ 20 mA	±20 mA, 0 ~ 20 mA, 4 ~ 20 mA (Required External 125 Ω Resistor)
Resolution	14-bit	14-bit	16-bit
Sampling Rate	10 Hz	10 Hz	10 Hz
Accuracy	±0.1% of FSR	±0.2% of FSR	±0.1% of FSR
Zero Drift	±0.5 μV/°C	±10 μV/°C	±0.5 μV/°C
Span Drift	±20 μV/°C	±25 μV/°C	±25 ppm
Overvoltage Protection	120 VDC / 110 VAC	240 Vrms	N/A
Input Impedance	20 MΩ	2 MΩ	20 kΩ
Common Mode Rejection	150 dB	86 dB	150 dB
Normal Mode Rejection	100 dB	100 dB	100 dB

PROFIBUS Analog Output Modules		
Model Name	PROFI-5024	
Pictures	4-Ch Voltage/Current Output Module	
		
Channels	4	
Wiring	Differential	
Voltage Output Range	±10 V	
Current Output Range	0 ~ 20 mA, 4 ~ 20 mA	
Resolution	14-bit	
Accuracy	For Voltage Output	±0.1% of FSR
	For Current Output	±0.2% of FSR
Isolation	3000 VDC	

PROFIBUS Digital I/O Modules							
Model Name	PROFI-5045	PROFI-5050	PROFI-5051	PROFI-5052	PROFI-5053	PROFI-5055	PROFI-5060
Pictures							
<b>DI</b>							
Channels		16	24	12	24	8	8
Isolation Voltage		-	3750 Vrms	5000 Vrms	-	3750 Vrms	3750 Vrms
Contact		Dry	Wet	Wet	Dry	Wet	Wet
Sink/Source (NPN/PNP)	-	Sink/Source	Sink/Source	Sink/Source	-	Sink/Source	Sink/Source
ON Voltage Level		+4 ~ +30 VDC	+10 ~ +50 VDC	+4 ~ +30 VDC	Open	+10 ~ +50 VDC	+4 ~ +30 VDC
OFF Voltage Level		+1 VDC Max.	+4 VDC Max.	+1 VDC Max.	Close to IN.GND	+4 VDC Max.	+1 VDC Max.
Input Impedance		-	10 KΩ	3 KΩ	-	10 KΩ	3 KΩ
<b>DO</b>							
Channels	24	8				8	4
Isolation Voltage	3750 Vrms	-				3750 Vrms	-
Type	Open Collector	Open Collector				Open Collector	Relay (Form C)
Sink/Source (NPN/PNP)	Sink	Sink	-	-	-	Sink	-
Load Voltage	+10 ~ +40 VDC	+10 ~ +30 VDC				+10 ~ +40 VDC	0 ~ 125 VDC 0 ~ 30 VDC
Max. Load Current	650mA/channel	30 mA/channel				650 mA/channel	0.6 A @ 125 VDC 2 A @ 30 VDC
<b>Communication</b>							
Connector	9-pin female D-Sub						
Baud Rate (bps)	9.6 k, 19.2 k, 45.45 k, 93.75 k, 187.5 k, 500 k, 1.5 M, 3 M, 6 M, 12 M						
Controller	Profichip VPCLS2						
Transceiver	ADI ADM2486						
Protocol	DP-V0						
Node Address	0 ~ 99 selected by rotary switch						

## 3.2 PROFIBUS Remote I/O Units



### PROFI-8155



### PROFI-8255



### PROFI-8455



### PROFI-8855



#### Features:

- Protocol & hierarchy: DP-V0 & DP-V1 Slave
- Detect transmission Rate Automatically (Max.12 Mbps)
- Support Device-Related & Channel-Related Diagnosis
- Address 0 ~ 126 Set by Rotary Switches or SSA-Telegram
- Support Hot-Swap for I-87K High-Profile I/O Modules
- 3000 VDC Isolation Protection on PROFIBUS side
- 1/2/4/8 I/O Slots for I-87K and I-8K Series I/O Modules
- 4 KV ESD Protection (contacting for any terminal)
- Operating Temperature: -25 ~ +75°C

#### Introduction:

The PROFIBUS Remote I/O Unit is designed for the slave device of PROFIBUS DP protocol. It supports up to 1/2/4/8 slots for ICPDAS I-8k, I-87k series I/O modules. In addition, we also provide hot-swap function for I-87k High Profiles series I/O modules. To setup network, users can choose and configure I/O modules by using the GSD file without any other settings.

#### Ordering Information:

Model No.	Description
<b>PROFI-8155-G CR</b>	PROFIBUS Remote I/O Unit with 1 Expansion Slot (RoHS)
<b>PROFI-8255-G CR</b>	PROFIBUS Remote I/O Unit with 2 Expansion Slots (RoHS)
<b>PROFI-8455-G CR</b>	PROFIBUS Remote I/O Unit with 4 Expansion Slots (RoHS)
<b>PROFI-8855-G CR</b>	PROFIBUS Remote I/O Unit with 8 Expansion Slots (RoHS)

# 4. CAN Bus I/O Products



CAN-2000 series and CAN-8000 series are designed for combining sensors and actuators into, CANopen or DeviceNet network. All of them provide corresponding EDS files for standard CANopen or DeviceNet master interfaces. The mainly differences between CAN-2000 series and CAN-8000 series are the product size and the capabilities of I/O expansion. CAN-2000 series is a palm-size and stand-alone slave device. CAN-8000 series is useful for centralizing control system. It provides 1/2/4/8 slots for flexible I/O selections to match various applications. Each slot allows you plugging one I-8000/I-87K series I/O module to expand I/O channels, and hot-swap technique is supported.

With the same hardware, the CAN-2000 series and CAN-8000 series can be installed either of, CANopen or DeviceNet firmware. The product names are classified as

- CANopen:** CAN-8x2**3**, CAN-2xxx**C**
- DeviceNet:** CAN-8x2**4**, CAN-2xxx**D**

## Features:

### 1 Heartbeat Messaging

The heartbeat protocol is generally used to negotiate and monitor the availability of remote I/O devices. It is a message like the heartbeat sent by CANopen/DeviceNet remote I/O modules at a regular time. The users could use this mechanism to indicate the health of the remote I/O. The health information is most important in the industrial applications. All the CANopen/DeviceNet remote I/O series from ICP DAS has the heartbeat protocol to increase the reliability of the remote data.



### 2 Safety & Arbitration

CAN bus provides five mechanisms for achieving the utmost safety of data transfer. There are powerful for error detection, signaling and self-checking are implemented in every CAN node. If two or more nodes start transmitting messages at the same time, the arbitration mechanism is applied to guarantee that one of these messages can be sent successfully according to the priority.

### 3 Auto Response of Input Data

The input data of CANopen/DeviceNet I/O modules allows to be responded automatically by event trigger or timer trigger. For example, DI data will be responded to the master when the DI data is changed. The AI data can be responded cyclically by predefined time period.

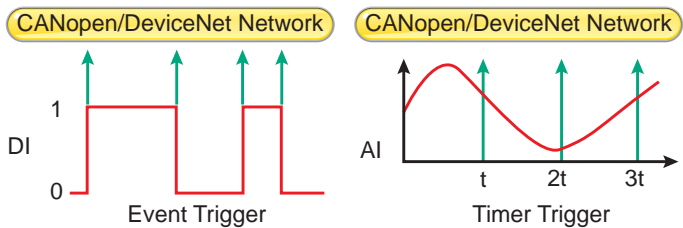

### 4 CANopen Digital I/O Pair-Connection

CANopen Digital I/O Pair-Connection is a special function for CANopen remote I/O. It can send the DI value that detected by the CANopen DI slave to other CANopen DO slaves through the CANopen network, and then these CANopen DO slaves will output the value. It is useful for users who need to detect a DI signal and output a DO alarm in time.

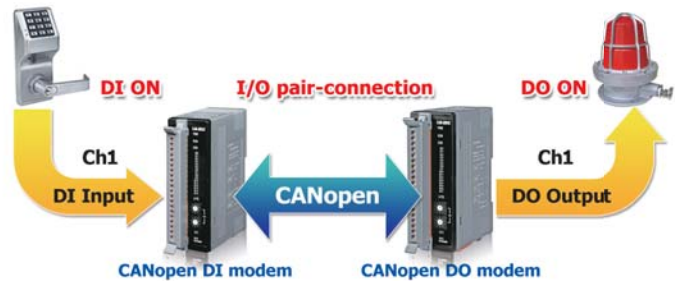

## 4.1 CAN Bus I/O Module

Multifunction I/O Module

Model Name	Protocol	Analog Input		Analog Output		Digital Input		Digital Output	
		Channels	Input Range	Channels	Output Range	Channels	Contact	Channels	Type
CAN-2026C	CANopen	6	±10 V, ±5 V, ±1 V, ±500 mV, ±150 mV, ±20 mA (with external 125 Ω resistor)	2	0 ~ +5 V, ±5 V, 0 ~ +10 V, ±10 V	2	Wet, Sink	1	Open Collector, Sink
CAN-2026D	DeviceNet								



Analog I/O Modules



Model Name	Protocol	Analog Input			Analog output	
		Channels	Input Range	Sensor	Channels	Output Range
CAN-2015C	CANopen	8	-	RTD (Pt100, Pt1000, Ni120, Cu100, Cu1000, Pt100)	-	
CAN-2015D	DeviceNet					
CAN-2017C	CANopen	8	±10 V, ±5 V, ±1 V, ±500 mV, ±150 mV, ±20 mA (with external 125 Ω resistor)		-	
CAN-2017D	DeviceNet					
CAN-2018C	CANopen	8	±2.5 V, ±1 V, ±500 mV, ±100 mV, ±50 mV, ±15 mV, ±20 mA (with external 125 Ω resistor)	Thermocouple (J, K, T, E, R, S, B, N, C)	-	
CAN-2018D	DeviceNet					
CAN-2019C	CANopen	10	±10 V, ±5 V, ±2.5 V, ±2 V, ±500 mV, ±100 mV, ±50 mV, ±15 mV, ±20 mA (with external 125 Ω resistor)	Thermocouple (J, K, T, E, R, S, B, N, C)	-	-
CAN-2019D	DeviceNet					
CAN-2024C	CANopen	-			4	0 ~ +5 V, ±5 V, 0 ~ +10 V, ±10 V, 0 ~ 20 mA, 4 ~ 20 mA
CAN-2024D	DeviceNet					

Digital I/O Modules



Model Name	Protocol	Digital Input			Digital output		
		Channels	Contact	Sink/Source	Channels	Type	Sink/Source
CAN-2053C	CANopen	16	wet	Sink/Source	-	-	-
CAN-2053D	DeviceNet						
CAN-2054C	CANopen	8	wet	Sink/Source	8	Open Collector	Sink
CAN-2054D	DeviceNet						
CAN-2055C	CANopen	8	wet	Sink/Source	8	Open Source	Source
CAN-2055D	DeviceNet						
CAN-2057C	CANopen	-	-	-	16	Open Collector	Sink
CAN-2057D	DeviceNet						
CAN-2060C	CANopen	4	wet/Dry	Sink/Source	4	Relay	Form A, 5A
CAN-2060D	DeviceNet						

Counter/PWM Modules



Model Name	Protocol	Counter Input				PWM Output			
		Channels	Signal	Resolution	Speed	Channels	Load Current	Resolution	Speed
CAN-2084C	CANopen	4 / 8	Up, Up/Down, Dir/Pulse, A/B phase, Frequency	32 bit	250 kHz	-	-	-	-
CAN-2084D	DeviceNet								
CAN-2088C	CANopen	8	Up Counter	32 bit	500 kHz	8	1 mA	16 bit	500 kHz
CAN-2088D	DeviceNet								

## 4.2 CAN Bus I/O Unit

CANopen DS 301 Ver 4.02/DS 401 Ver 2.1 Specification



Model Name	Interface
CAN-8123-G	CANopen Embedded Device with 1 I/O Expansion Slot, support I-87K module and I-8K module
CAN-8223-G	CANopen Embedded Device with 2 I/O Expansion Slots, support I-87K module and I-8K module
CAN-8423-G	CANopen Embedded Device with 4 I/O Expansion Slots, support I-87K module and I-8K module
CAN-8823-G	CANopen Embedded Device with 8 I/O Expansion Slots, support I-87K module and I-8K module

DeviceNet Volume I Ver 2.0, Volume II Ver2.0



Model Name	Interface
CAN-8124-G	DeviceNet Embedded Device with 1 I/O Expansion Slot, support I-87K module and I-8K module
CAN-8224-G	DeviceNet Embedded Device with 2 I/O Expansion Slots, support I-87K module and I-8K module
CAN-8424-G	DeviceNet Embedded Device with 4 I/O Expansion Slots, support I-87K module and I-8K module
CAN-8824-G	DeviceNet Embedded Device with 8 I/O Expansion Slots, support I-87K module and I-8K module

# 5. USB I/O Modules

ICP DAS USB series I/O modules are highly flexible solution to acquire or output data. User can build up own PC-based control, laboratory research, testing and so on by applying ICP DAS USB series I/O modules. The advantages of ICP DAS USB I/O modules are small size, portable, plug & play and various input type to help user build up own project easily and quickly in different field and application. These I/O modules can be applied in wide range application, ex: fan-less control or measurement, automatically testing systems...etc. ICP DAS provides two kinds of USB series I/O as below.



## 1. USB-2000 I/O :

It provides 10KS/s data acquisition functionality and powered by USB port. User can apply this to real-time demanded application, ex: vibration current measurement.

## 2. USB-87Pn I/O:

We also developed USB-87Pn, a series of USB remote I/O unit for compact and modular I/O expansion. It comprises a CPU, a power module and a backplane with a number of I/O slots for flexible I/O configuration.

The brief comparison is as the following table.

Model Name	USB-2000	USB-87Pn
Pictures		
Cable	USB type A connector	USB type A connector
Protocol	USB HID	DCON (ASCII Format)
Power Supply	USB port	+10 ~ +30 VDC via wiring
Rate	12 Mbit/s (USB 2.0 Full-Speed)	115200 bit/s (default)
Slot for I/O Unit	-	1/2/4/8
Size	72 mm × 123 mm × 35 mm 129 mm × 147 mm × 31 mm	64 mm × 120 mm × 110 mm (min) 312 mm × 132 mm × 111 mm (max)
SDK and Sample	VB, C++, C#.Net, VB.Net, Linux driver	Dll, Labview, InduSoft, Linux, OPC server

## Features:

- **USB bus powered** - Plug and Play
- **Dual Watchdog** - Hardware and Communication WDT
- **Power On Value & Safe Value** - When output module power-on, reset, or communication timeout
- **Highly Reliable Under Harsh Environment** - From -25 to 75°C

## Selection Guide:



Model Name	Interface	Description
 <b>USB-87P1</b> <b>USB-87P2</b> <b>USB-87P4</b> <b>USB-87P8</b>	USB 2.0	I/O Expansion Unit with 1/2/4/8 slots, support I-87K series I/O modules

### Selection Guide:





USB Analog I/O

Model Name	Interface	Analog Input					Analog Output		
		Channels	Resolution	Input Type	Isolation	Sampling Rate	Channels	Resolution	Output Type
 <b>USB-2019</b>	USB 2.0	8	16-bit	15 mV, 50 mV, 100 mV, 150 mV, 500 mV, 1 V, 5 V, 10 V, 20 mA, 0 ~ 20 mA, 4 ~ 20 mA, J, K, T, E, R, S, B, N, C, L, M, LDIN43710	3000 VDC	10 Hz	-	-	-

USB Multifunction I/O

Model Name	Interface	Analog Input			Analog Output		Digital Input		Digital Output		
		Channels	Resolution	Sampling Rate	Channels	Resolution	Channels	Type	Channels	Type	Rating
 <b>USB-2026</b>	USB 2.0	5	14/12	10/200 Hz	2	12	2	Dry, Source	2	OC, Sink	700 mA

USB Digital I/O

Model Name	Interface	Digital Input		Digital Output		
		Channels	Type	Channels	Type	Rating
 <b>USB-2045</b>	USB 2.0	-	Dry, Source	16	Open Collector, Sink	700 mA/Channel
 <b>USB-2045-32</b>	USB 2.0	-	Dry, Source	32	Open Collector, Sink	500 mA/Channel
 <b>USB-2051</b>	USB 2.0	16	Dry, Source Wet, Sink/Source	-	-	-
 <b>USB-2051-32</b>	USB 2.0	32	Dry, Source Wet, Sink/Source	-	-	-
 <b>USB-2055</b>	USB 2.0	8	Dry, Source Wet, Sink/Source	8	Open Collector, Sink	700 mA/Channel
 <b>USB-2055-32</b>	USB 2.0	16	Dry, Source Wet, Sink/Source	16	Open Collector, Sink	600 mA/Channel
 <b>USB-2060</b>	USB 2.0	6	Dry, Source Wet, Sink/Source	6	Power Relay, Form A (SPST N.O)	5 A
 <b>USB-2064</b>	USB 2.0	-	-	8	Form A (SPST N.O.)	5 A
 <b>USB-2064-16</b>	USB 2.0	-	-	16	Form A (SPST N.O.)	3 A
 <b>USB-2068-18</b>	USB 2.0	10	Dry, Source Wet, Sink/Source	8	Signal Relay, Form C (DPDT)	2 A @ 30 VDC 0.24 A @ 220 VAC

USB Pulse I/O

Model Name	Interface	Pulse Input			Pulse Output		
		Channels	Input Frequency	Isolation	Channels	Resolution	Output Type
 <b>USB-2084</b>	USB 2.0	4 Up/Down (CW/CCW) 4 Dir/Pulse (Bi-direction) 4 A/B Phase (Quadrant Counting) 8 Up Counter, Frequency	TTL: 500 KHz maximum Isolated: 250 KHz maximum	2500 VDC	-	-	-

	IIoT Overview	P 4-1
1	IoTstar: IIoT Cloud Management Software	P 4-2
2	UA-5200 IIoT Communication Server	P 4-5
3	WISE Series	P 4-7
4	iCAM Series	P 4-15
5	MQTT I/O Module	P 4-17
6	CL Series: Smart Environmental Monitoring	P 4-18
7	DL Series: Smart Environmental Monitoring	P 4-21
8	PIR/RPIR Series: Motion Detector	P 4-26
9	Bluetooth LE Gauge Master for Mitutoyo Gauges	P 4-28
10	Stack Light Monitoring Module	P 4-29
11	Accelerometer Data Logger Module	P 4-31





# IIoT Overview

Industrial Internet of Things (IIoT) is the new cloud trend, and the IoT technology which makes all the devices communicated with each other is the first jigsaw puzzle of the entire cloud vision. To meet the demand for industry, ICP DAS offers software, controllers, I/O modules and sensors. Our goal is to take the data to the cloud and make the whole system very easy to monitor, manage and maintain.

## 1 IoTstar

The IoT cloud management software to monitor, manage and maintain the controllers, I/O modules and sensors.



## 2 UA-5200 series

The communication servers which support OPC UA, Modbus and MQTT protocol.



## 3 WISE series

The smart front end controllers and I/O modules for IIoT.



## 4 iCAM series

The network cameras co-work with WISE to implement new surveillance solution.



## 5 MQ-7200M series

The I/O modules which support MQTT protocol.



## 6 Sensors

Various sensors with communication interface to measure temperature, humidity, dew point, CH4 methane, CO, CO2, PM2.5, etc.



# 1. IoTstar: IIoT Cloud Management Software

Build your IIoT with ICP DAS IoTstar



<http://iotstar.icpdas.com>

IoTstar is a software developed by ICP DAS for use in remote management of the IIoT concentrators on a private or public cloud platform such as: Microsoft Azure, IBM Bluemix or Amazon AWS, etc.. With the help of the IoTstar and the IIoT concentrators, data of I/O modules or sensors can be quickly and easily collected and imported to the database on the cloud platform; and users can analysis and generate report by using the tools provide by the cloud platforms.

## Features:

1. Based on Public Cloud: Microsoft Azure, IBM Bluemix, Amazon AWS
2. Based on Private Cloud: Microsoft Windows 7/8/10
3. Remote Management and Maintenance
4. Remote Monitoring and Control
5. Cloud Big Data
6. Data Analysis and Report by Public Tools

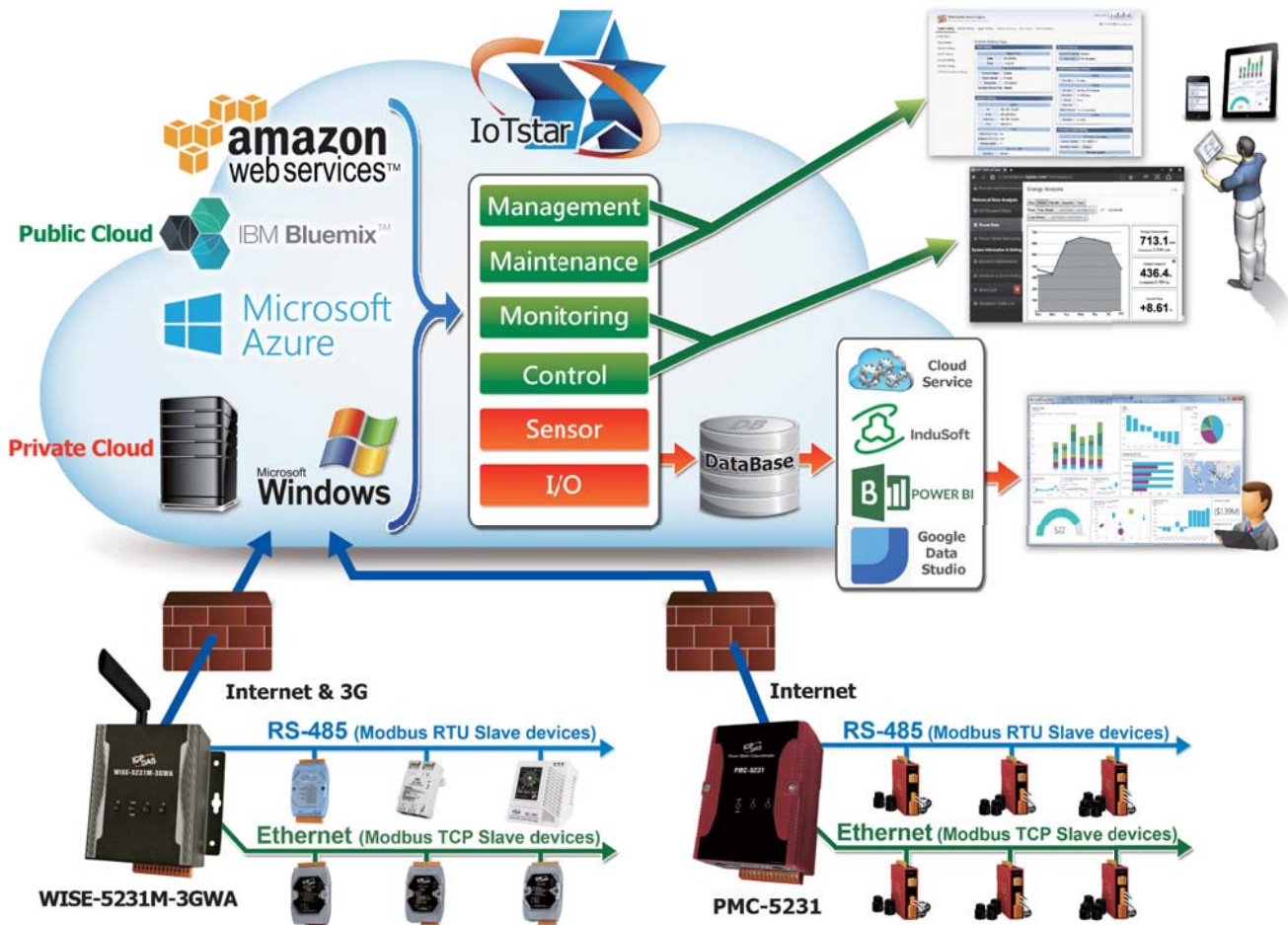



### Based on Public Cloud

Can be installed on Microsoft Azure, IBM Bluemix or Amazon AWS to implement the public IoT cloud solution.



### Based on Private Cloud

Support Windows system (Windows 7/8/10, Windows Server) to implement the private IoT cloud solution.



### Remote Management and Maintenance

Enables the remote management and firmware update on the controllers via user-friendly and intuitive Web page interface.

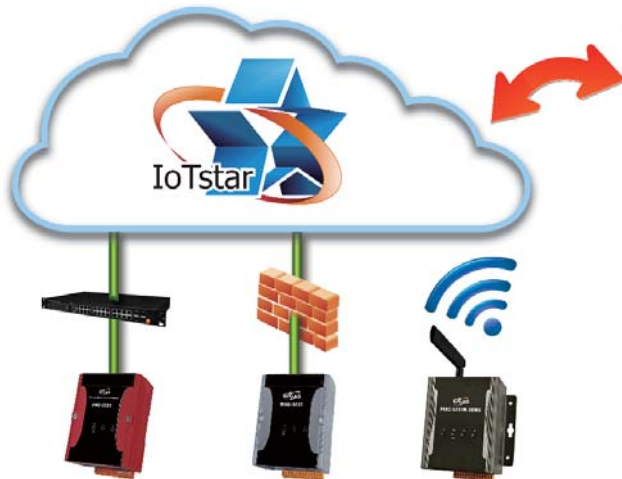

### Remote Monitoring and Control

User can retrieve and review the data of the sensors directly by the built-in Web page interface.

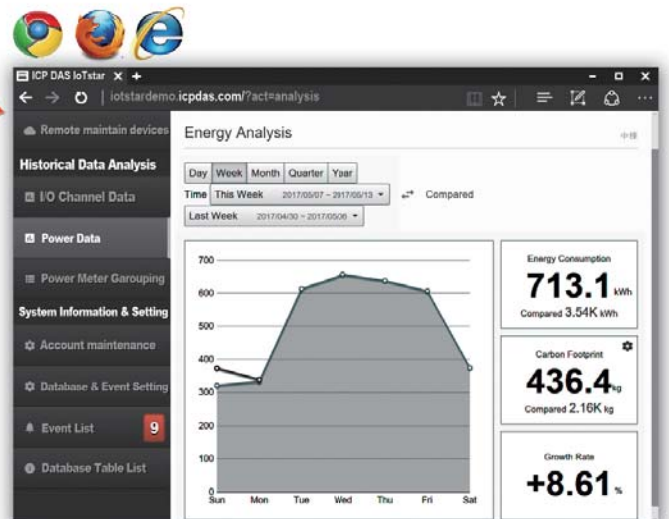
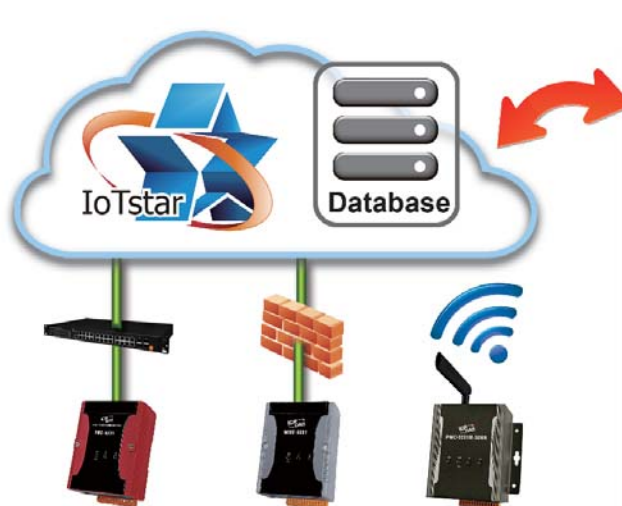

## Cloud Big Data

Receive the data log file of the sensors from the remote IIoT concentrators and import the content of the data log file into the Database (MySQL or MS SQL).



## Analysis and Report by Public Tools

By Database interface, it is easy to integrate with SCADA, Microsoft Power BI, Google Data Studio or Cloud Service to retrieve the data of the Sensors directly from the Database for future data analysis.

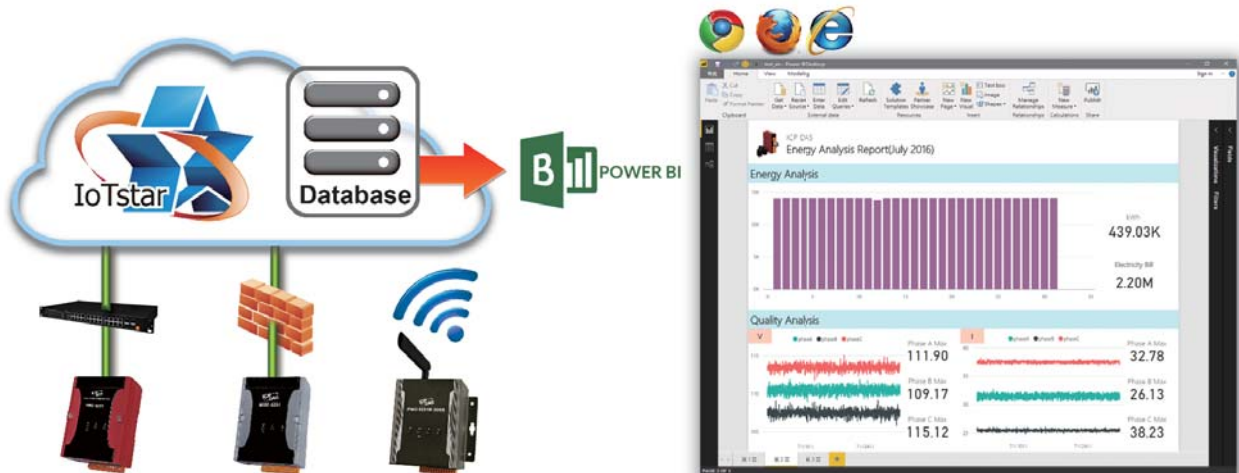

▲ Analysis and Report by Microsoft Power BI



▲ Analysis and Report by Google Data Studio

## Products support IoTstar:



**WISE-5231 series:**  
smart front-end sensor and I/O module concentrator for Industrial IoT



**WISE-5231M-3GWA**  
smart front-end sensor and I/O module concentrator with 3G concentrator for Industrial IoT



**PMC-5231 series:**  
smart front-end power meter concentrator for Industrial IoT



**PMD series:**  
smart front-end power meter concentrator with touch panel display for Industrial IoT



# 2. UA-5200 IIoT Communication Server

## UA-5231

IIoT Communication Server, with 1 Ethernet port (RoHS)

## UA-5231M

## UA-5231M-3GWA/4GE

## UA-2241

IIoT Communication Server (Metal) (RoHS)

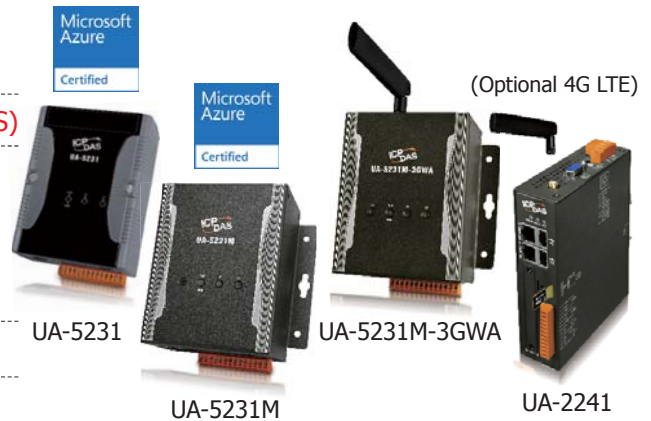

### Features:

- OPC UA Server
- MQTT Broker Inside
- ARM CPU, 1.0 GHz
- Linux kernel 3.2.14 OS
- Support Redundancy (OPC UA) and PID
- 10/100/1000 Mbit/s Ethernet Port
- 4 Serial Ports (RS-232/RS-485)
- Operating Temperature: -25 ~ +75°C

### Introduction:

The UA-5200/2241 series is an IIoT communication server. It has built-in OPC UA server, MQTT broker and client driver to meet the need to connect to the MES, ERP, SCADA and cloud service. And with the Ethernet, RS-232, RS-485 interfaces and Modbus TCP/RTU/ASCII protocol, the UA-5200/2241 series can access regular remote I/O modules or controllers that already widely used in the factory. With the UA-5200/2241 series, it becomes very easy to make things used in the factory connect to MES, ERP, SCADA and cloud.

### Functions:

#### ■ Web-based UI

With the Web-based User Interface, users can log in and configure the controller via a regular web browser that only need a mobile device or computer with web browsing capabilities.

UA-2241 UA-5200

#### ■ OPC UA Server: IEC 62541 Standard

The OPC UA Server certified by the OPC Foundation can assist the integration for the local-end devices, actively upload data to the application system.

#### ■ PID Logic Operation

The PID function can dynamically combine the remote I/O devices for the PID logic control to provide temperature control and case field solutions.

#### ■ Support Modbus TCP/RTU/ASCII Master

Through the controller's RS-485, RS-232 and Ethernet ports can connect to the Modbus TCP/RTU/ASCII Slave devices. Build systems with scalability and flexibility to meet the diverse application needs and expansion at any time.

#### ■ MQTT Broker Inside

Compliance with MQTT v3.1.1 protocol. Support MQTT message distribution management. Users do not need to build Broker system when using MQTT communications.

#### ■ Support MQTT Protocol

Support MQTT to allow the IoT devices communicating with the OPC UA system and the UA-5200/2241 conducting the data acquisition and management; and also can convert and publish the devices' data under the UA-5200/2241 to the IoT system.

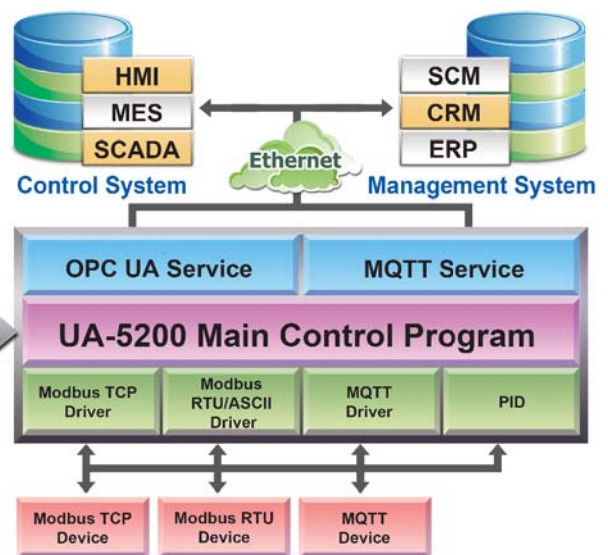

## System Integration Main Architecture:

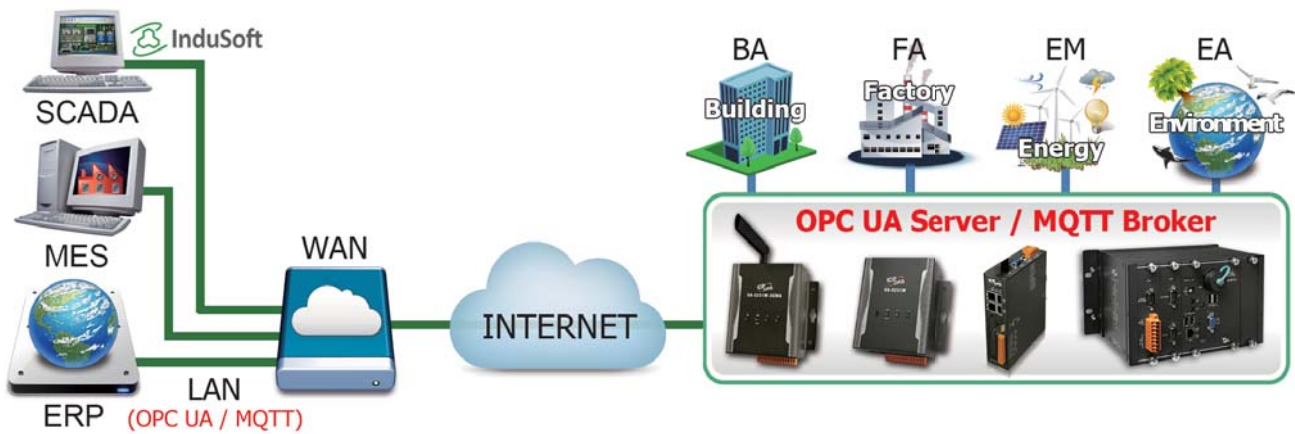

## Solutions:

### 1 (Modbus ↔ OPC UA)

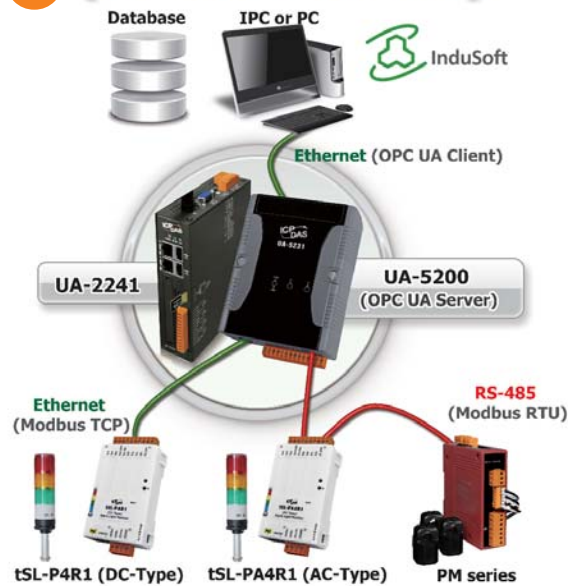

### 2 (Modbus ↔ MQTT)



### 3 (MQTT ↔ OPC UA)



### 4 (MQTT ↔ MQTT)





### 3. WISE Series



## Smart Front End for IIoT

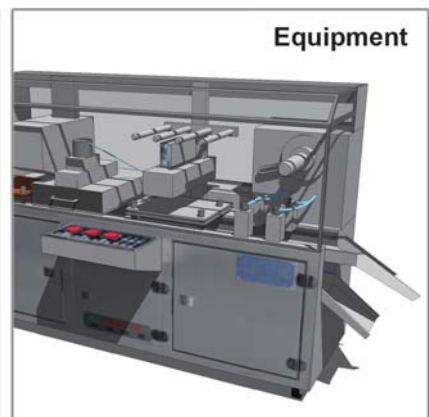
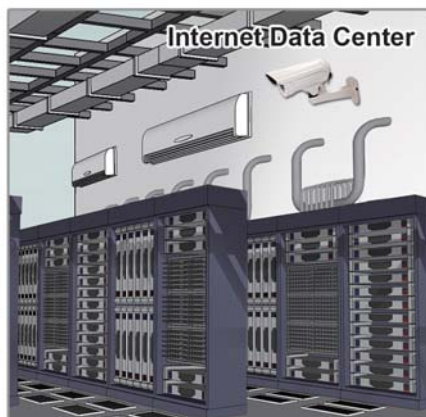
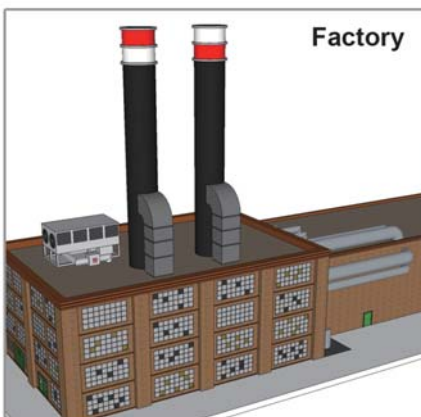

The trend of "Industry 4.0" has brought numerous upgrade requirements in industries. For a smart factory, each process or equipment is required to operate independently and is able to communicate with each other. ICP DAS has developed a series of WISE controllers and I/O modules, which allows to getting down to the smart front-end. With the built-in intelligent logic engine and a wide range of I/O modules, it can perform monitoring of the on-site sensors and devices in real time; and then it can connect with the network system seamlessly via the MQTT communication protocol. By using WISE series of controllers and I/O modules, the users can design a variety of combinations to meet the requirements from all applications; and achieve the Internet of things vision with ease.

ICP DAS WISE Product Line & Traditional Ethernet I/O Module Comparison	
ICP DAS WISE Product Line	Traditional Ethernet I/O
Built-in logic engine, can proceed complex operations	Just simple input, output operations
Supports MQTT for IoT system	Does not support MQTT
Provides management software on the cloud	N/A
<p>Microsoft Azure certified (WISE-5231, WISE-5231M-3GWA)</p> 	N/A



# WISE family

Product Series		WISE-2241 Series	WISE-5231 Series	WISE-5800(-MTCP) WISE-5801(-MTCP)
Pictures				
Hardware	CPU	32 bit (1 GHz)		16 bit (80 MHz)
	Ethernet Interface	2×10/100/1000 Base-TX	1×10/100/1000 Base-TX	1×10/100 Base-TX
	MicroSD Interface	Yes (Max. 32 GB microSD)		Yes (Max. 4 GB microSD)
	I/O Channel Operation	XV-board, RS-485, Ethernet		XW-board, RS-485 (WISE-580x), Ethernet (WISE-580x-MTCP)
Software Function	IF-THEN-ELSE Logic Rule	Yes		Yes
	Schedule	Yes (Calendar and Weekly repeat mode)		Yes (Calendar mode)
	Data Logger	Yes (Multiple sets)		Yes (One set)
	Connect with SCADA	Modbus TCP/RTU, SSL Email, FTP Client/ Server, CGI sending/receiving, <b>MQTT</b> , <b>SNMP</b>		Modbus TCP/RTU, non-SSL Email, FTP Client, CGI sending
	SMS & Wireless Communication	4G System : WISE-5231M-4GE/WISE-2241M-4GE 3G System : WISE-5231M-3GWA		2G SMS for WISE-5801(-MTCP)
	Support IoTstar	Yes	Yes	-

Product Series		WISE-75XXM Series	WISE-71XX Series
Pictures			
Hardware	CPU	32 bit (400 MHz)	16 bit (80 MHz)
	Ethernet Interface	10/100 Base-TX, 2-port Ethernet Switch Support Daisy-Chain Connection	10/100 Base-TX
	I/O Channel Operation	Yes	Yes
Software Function	IF-THEN-ELSE Logic Rule	Yes	Yes
	Schedule	Yes	-
	Data Logger	-	-
	Connect with SCADA	Modbus TCP, non-SSL Email, CGI sending, <b>MQTT</b>	Modbus TCP, non-SSL Email, CGI sending
Support IoTstar	-	-	



# WISE Surveillance Solution

A general surveillance system on current market usually features separated systems: the camera DVR/NVR as a system, and the I/O monitoring as another system; each system operates independently. For now the DVR/NVR system of the camera usually records video for 24H/7Day without interruption, it requires huge storage space and sufficient network bandwidth; therefore the system implementation fee is usually high. In addition, when playback a certain video, it does not allow to search the suspicious activities of related I/O (temperature, doors and windows switch, water level, etc.) at the same time.

ICP DAS WISE surveillance solution integrates logic control, I/O, camera and data log in one single WISE controller. WISE allows two-way interactions between the I/O and the camera; it enables to record a piece of video or to take images when there is an event triggered by either I/O condition or ROI (Region of Interest) by camera. In this way, the storage size can be reduced significantly and the connection between I/O event and Video/Image can be built for easy query.

ICP DAS WISE Surveillance Solution	Regular Surveillance Solution
1. One WISE controller to integrate camera and I/O	1. Two independent systems: SCADA & DVR/NVR
2. Records key video and image, only needs a few storage memory.	2. Record video 24H/7Days, needs huge storage memory.
3. Two-way interaction between I/O and Video/Image	3. I/O and Video/Image are independent
4. Can work stand along or be integrated into a SCADA system	4. Needs a host PC to run the SCADA
5. One stop shopping/service for <ul style="list-style-type: none"> <li>● Controller: WISE Series</li> <li>● I/O Modules: Various options for RS-485, Ethernet interfaces</li> <li>● Camera: Bullet, Fisheye, Dual Lens</li> <li>● SCADA: InduSoft</li> </ul>	5. Buy from different venders for SCADA, I/O Modules, DVR/NVR

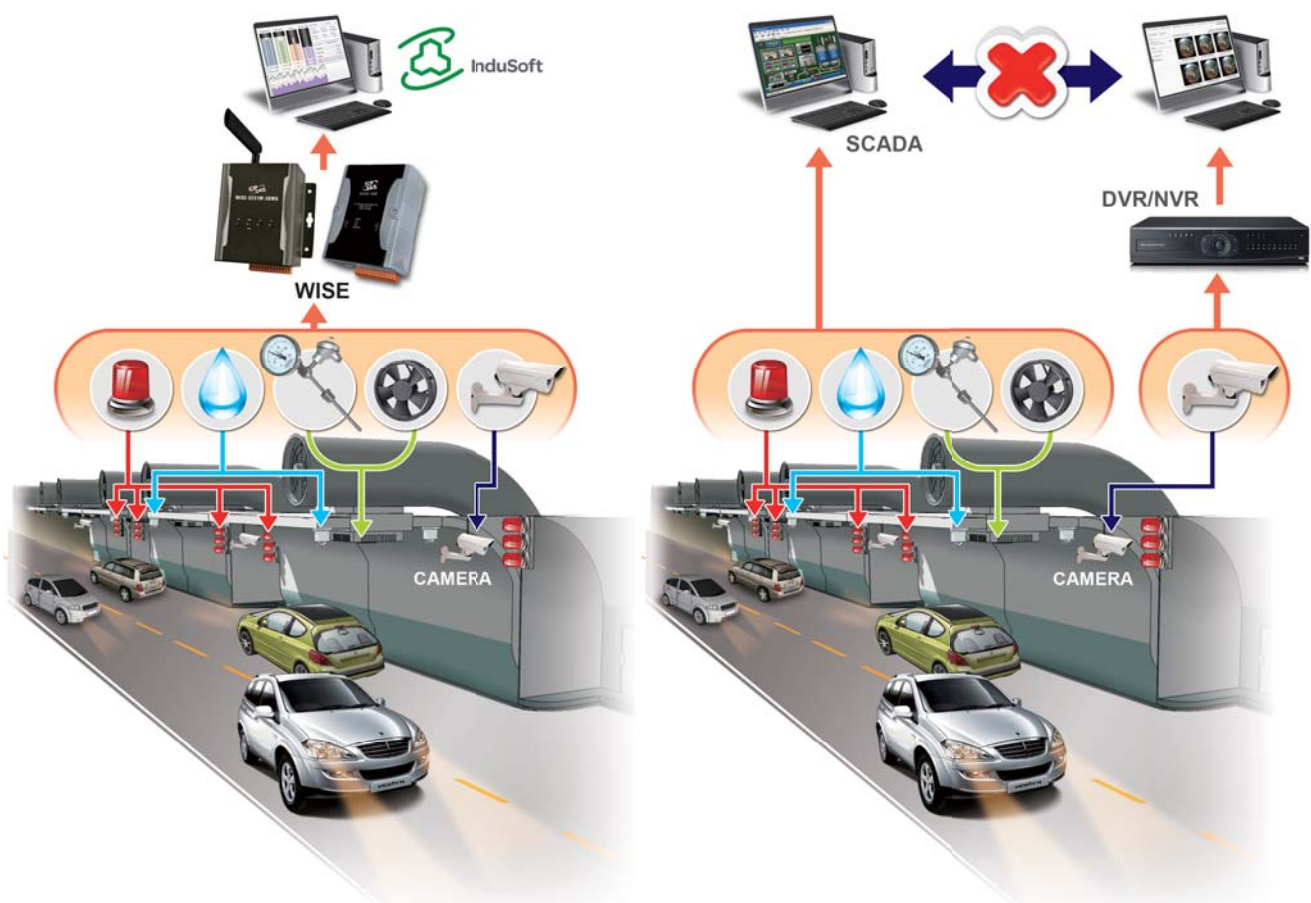

# WISE Introduction

WISE (Web Inside, Smart Engine) is a product series developed by ICP DAS that functions as control units for use in remote logic control and monitoring in various industrial applications. WISE offers a user-friendly and intuitive web site interface that allows users to implement IF-THEN-ELSE control logic on controllers just a few clicks away; no programming is required. With its powerful and easy-to-use features, it will minimize the learning curve, shorten time to market and dramatically reduce the labor and cost spent on system development.

## WISE System Architecture



### IF-THEN-ELSE logic rules execution ability

WISE controller features an IF-THEN-ELSE logic rule engine; it offers IF-THEN-ELSE rules for users to set up the logic content. After completing rule edition and downloading rules to the WISE, the rule engine will loop execute the rules in accordance with the execution order under specific conditions.

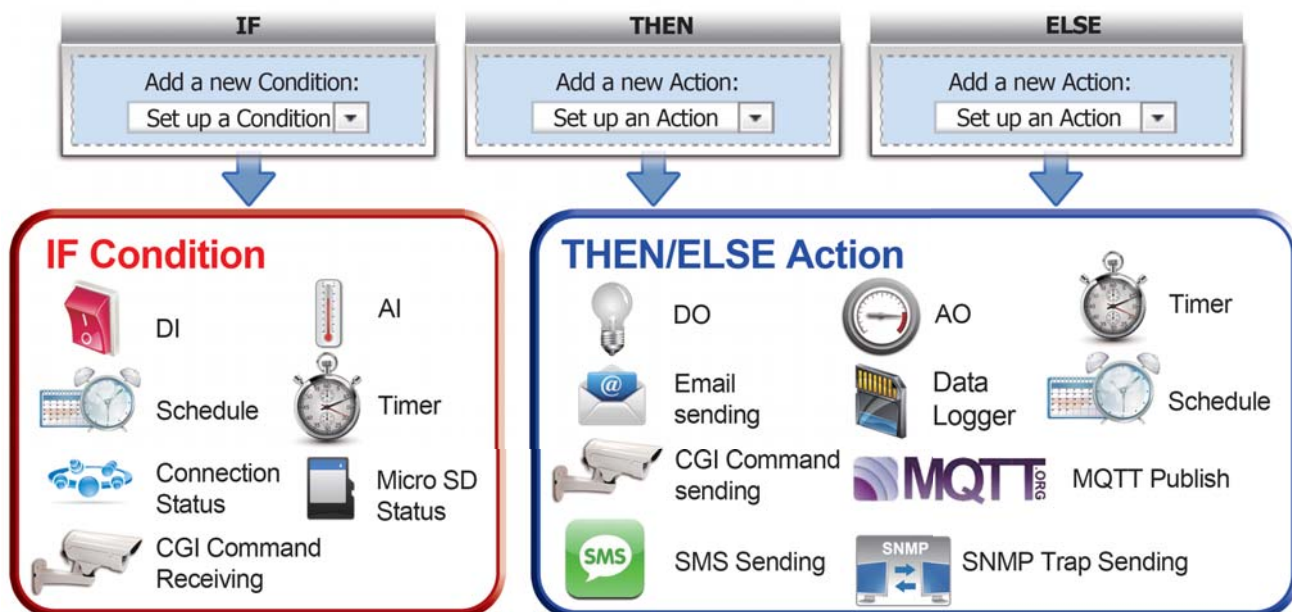

## Offer various options for I/O channel settings

WISE offers various options for I/O channel settings; for example: noise filter for DI signals, Deadband setting for AI signals, linear scale setting, temperature degree in Celsius or Fahrenheit setting, power on value setting for DO channel, pulse output setting and DI/DO counter setting, etc.

The image shows two screenshots from the WISE web interface. The top screenshot is the 'Modbus RTU Module List' for COM3, showing a table of modules with columns for No., Address, Module Name / Nickname, Polling Timeout(ms), and Retry Interval(secs). The bottom screenshot is the 'AI Attribute' setting page, showing a table for AI channels with columns for Channel Name, Type, and Scale. It includes input fields for Channel Name and Type, and dropdown menus for Scale.

▲ AI Channel Setting Page

The image shows the 'DO Channel Setting Page' in the WISE web interface. It includes sections for 'Module XV310 Setting' with fields for Nickname and Description, and a table for DO channels. The table has columns for Channel Name, Power On Value, and Advanced Function. A dropdown menu is open for the 'Advanced Function' of Ch.0, showing options like 'Disable', 'Pulse Output', 'Auto OFF', and 'DI Status Mapping'.

▲ DO Channel Setting Page

## Provide Timer and Schedule operation

WISE features Timer and Schedule functions: It allows user to schedule specific date or time for control logic execution, or perform specific tasks such as time delay. With calendar user interface provided, Schedule setting can be more efficient and flexible.

The image shows the 'Schedule Setting' page in the WISE web interface. It includes sections for 'Schedule Schedule 1 Setting' with fields for Nickname and Description, and 'Schedule Content Setting' with options for Mode (Calendar/Repeat), Date, and Time Range. A calendar view for February 2017 is shown at the bottom.

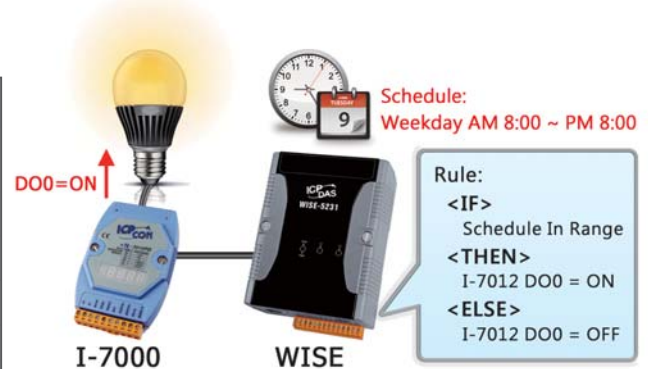

The image shows the 'Timer Setting Page' in the WISE web interface. It includes sections for 'Timer Setting' with fields for Nickname, Initial Status, and Period, and a table for timer settings with columns for Delay Action Timer and Power On Timer.

▲ Schedule Function



## Well-thought-out CGI command operation with IP Camera

WISE supports full CGI command operations - CGI command sending and CGI command receiving. The CGI command sending action can be added to the logic edition as part of logic control in response to specific events. The CGI command receiving function enables WISE to receive the CGI commands from others network devices. The content of CGI command received can be used in IF condition statements to trigger the THEN/ELSE actions.



1 PAC Products and BoxPC

2 Panel Products

3 Remote I/O Module and Unit

4 IIoT



### Selection Guide:

ICPDAS provides various WISE controllers for users to choose from to meet their demands for use in various industrial applications:

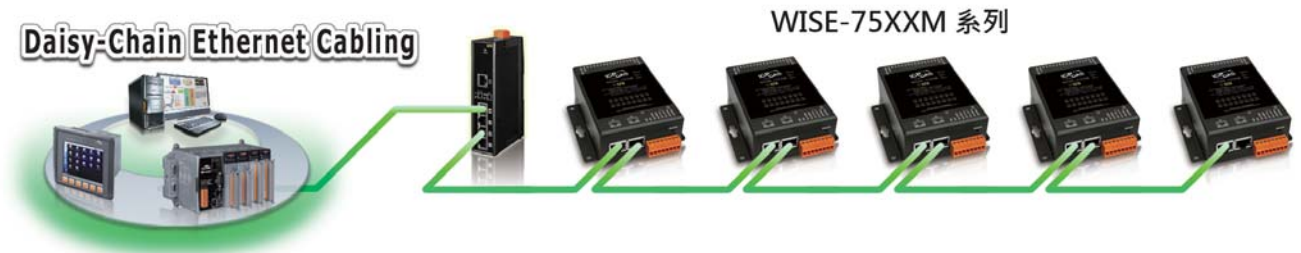

### WISE-71xx Intelligent I/O Modules

Model Name	WISE-7102	WISE-7105	WISE-7115	WISE-7117	WISE-7118Z	WISE-7119	WISE-7126
Pictures							
Model Name	WISE-7502M	WISE-7504M	WISE-7515M	WISE-7517M	WISE-7518ZM	WISE-7519ZM	WISE-7526M
Pictures							
Ethernet Port	10/100 Base-TX with PoE (Power over Ethernet)						
Local I/O Function	DI	6	-	-	-	-	2
	DO	3	4	-	4	6	4
	AI	3	8	7	8	10	8
	AO	-	-	-	-	-	-
Over Voltage Protection	240 Vrms	110 VDC/VAC	-	240 Vrms	240 Vrms	240 Vrms	240 Vrms
Note	-	Support Thermistor	Support RTD	-	Support Thermocouple Input		-

Model Name	WISE-7142	WISE-7144	WISE-7151	WISE-7152	WISE-7153	WISE-7160	WISE-7167
Pictures							
Model Name	WISE-7542M	WISE-7544M	WISE-7551M	WISE-7552M	WISE-7553M	WISE-7560M	WISE-7567M
Pictures							
Ethernet Port	10/100 Base-TX with PoE (Power over Ethernet)						
Local I/O Function	DI	-	8	16	8	16	6
	DO	16 (Sink Type)	8 (Sink Type)	-	8 (Source Type)	-	6 (Power Relay)
Note	-	WISE-7153's DI channel is for Dry Contact (Source). Other's DI channel is for Wet Contact (Sink, Source).				-	-

# I/O Expansion for WISE-580x

## I/O Expansion Boards (XV-board) for WISE-5200

DIO Board							
Model Name	Series	DI			DO		
		Channels	Sink/Source	Contact	Channels	Type	Sink/Source
XV107	XV	8	Source	Wet	8	Open Collector	Sink/Source
XV107A		8	Sink		8	Open Emitter	Source
XV110		16	Sink/Source	Wet + Dry	-	-	-
XV111		0	-	-	16	Open Collector	Sink
XV111A		0	-	-	16	Open Emitter	Source
XV116		5	Sink/Source	Wet	6	Power Relay, Form A	-

Multifunctional Board									
Model Name	Series	AI		AO		DI		DO	
		Channels	Type	Channels	Type	Channels	Type	Channels	Type
XV306	XV	4	Voltage/Current	-	-	4	Wet	4	Relay, FormA, 6A
XV307		-	-	2	Voltage/Current	4	Wet	4	Relay, FormA, 6A
XV308		8	Voltage/Current	-	-	DI+DO=8	Dry, Source	DI+DO=8	Open Collector, Sink
XV310		4	Voltage/Current	2	Voltage/Current	4	Dry, Source	4	Open Collector, Sink

## I/O Expansion Boards (XW-board) for WISE-58xx(-MTCP)

DI, DO Expansion			
Model Name	DI	DO	Isolation
XW107	8	8	-
XW107i			3750 Vrms
XW110i	16	-	3750 Vrms

AI, AO, DI, DO Expansion							
Model Name	AI (12-bit)		AO (12-bit)		DI	DO	Isolation
	Channels	Range	Channels	Range			
XW304	6	±5 V	1	±5 V	4	4	-
XW310	4	±10 V	2	±10 V	3	3	
XW310C	4	0 ~ 20 mA	2	0 ~ 20 mA	3	3	

## I-7000 Remote I/O Module

AI/AO Module					
Model Name		AI	AO	DI	DO
Voltage/Current	I-7012	1	-	1	2
	I-7017	8	-	-	-
Thermocouple	I-7011	1	-	1	2
	I-7018	8	-	-	-
	I-7019	8	-	-	-
RTD	I-7013	1	-	-	-
	I-7015	6	-	-	-
	I-7033	3	-	-	-
Thermistor	I-7005	8	-	-	6
Transmitter	I-7014	1	-	1	2
Analog Output	I-7021	-	1	-	-
	I-7022	-	2	-	-
	I-7024	-	4	-	-
	I-7024R	-	4	5	-

Others			
Model Name		DI Counter	DO
Counter/Frequency	I-7080	2	2
Model Name		DI	PWM Output
PWM	I-7088	8	8

DI/DO Module				
Model Name		DI	DO	
Digital Input	I-7041	14	-	
	I-7051	16	-	
	I-7052	8	-	
	I-7053	16	-	
	I-7058	8	-	
	I-7059	8	-	
Digital Output	I-7042	-	13	
	I-7043	-	16	
	I-7045	-	16	
Digital Input & Output	I-7044	4	8	
	I-7050	7	8	
	I-7055	8	8	
	Relay Output	I-7060	4	4
		I-7061	-	12
		I-7063	8	3
		I-7065	4	5
I-7066	-	7		
I-7067	-	7		

# 4. iCAM Series

## Bullet Network Camera



**iCAM-721F**



### Introduction:

iCAM-721F is a professional bullet camera offering 1080p Full HD resolution with superb image quality up to 30 fps. Featuring 3-Megapixel resolution and high-performance H.264/MPEG-4/MJPEG compression technology, the iCAM-721F offers extra-smooth video and wide coverage.

iCAM-721F employs many advanced features to allow users to fully utilize the high definition video. Focus on a region of interest (ROI) in the camera view to enhance image quality. It also saves the cost of network and backend storage without network bandwidth of video streaming.

Aimed at outdoor surveillance, iCAM-721F is furnished with an Fixed-iris lens, a removable IR-cut filter, 15-meter IR illuminators, Wide Dynamic Range (WDR), and multi-functional environment profile image settings for superior image quality around the clock. Moreover, the IP67-rated housing protects against rain and dust and ensures functional operation in all types of weather conditions.

With other advanced features such as Motion detection, 802.3af compliant PoE, ONVIF Compliant for interoperability, built-in MicroSD/MicroSDHC/MicroSDXC card slot for storage, two-way audio, and digital input / output for alarm, the iCAM-721F is an all-in-one bullet network camera for detailed surveillance in outdoor environments.



## IR Fisheye Network Camera



**iCAM-771**



**360° Panoramic View**



**180° Panoramic View**

### Introduction:

iCAM-771 is the Fish-eye IR Network Camera, featuring a detailed 5-Megapixel resolution sensor with clear image quality. Equipped with a fish-eye lens for 360°/180° panoramic view without blind spots, certified ImmerVision Enables 2.0, the cameras are able to provide coverage of wide, open areas, such as airports, shopping malls, factories, parking lots, retail stores, offices and more.





# Dual Lens Panoramic Dome Network Camera

## iCAM-760D



iCAM-760D  
with outdoor  
6" dome housing

### Features:

- 2 × 5 Megapixel Progressive CMOS Sensor
- Smooth 15 fps@High 7.3 Megapixels Resolution (3840 × 1920)
- H.264/MJPEG Dual Codec
- 1.05 mm non-linear Fisheye Lens + 6/8/12/16 mm Fixed-focal Lens
- Removable IR Cut, Day & Night Function for Both Sensors
- eWDR Image Enhancement for Extreme Lighting Condition (too Bright/Dark)
- Various Display Modes Selectable for Different Applications
- ePTZ, Auto Pan, Auto Patrol Function on Fisheye Lens
- Two-way Audio
- Built-in MicroSD/MicroSDHC/MicroSDXC Card Slot for On Board Storage
- Weather-proof IP66-rated Outdoor Housing
- Built-in 802.3af Compliant PoE
- ONVIF 2.2 Compliant for interoperability

### Introduction:

Panorama and detail, iCAM-760D dual lens camera provides a professional single camera solution. Integrated with Dual 5-Megapixel sensors, one equipped with f 1.05mm non-linear fisheye lens offers 180/360 degree de-warped image (single or multiple), for the other sensor, lens is 6, 8, 12, 16mm optional. Dual sensors gimbals work independently and can be configured to almost any direction, and de-warping algorithms are 180/360 degree selectable depends on fisheye lens configuration. Wide Dynamic Range and IR cut removable are available for both sensors. iCAM-760D offers a professional and efficient solution for commercial, industrial, and public areas.



360° Panoramic View + Fixed-focal View

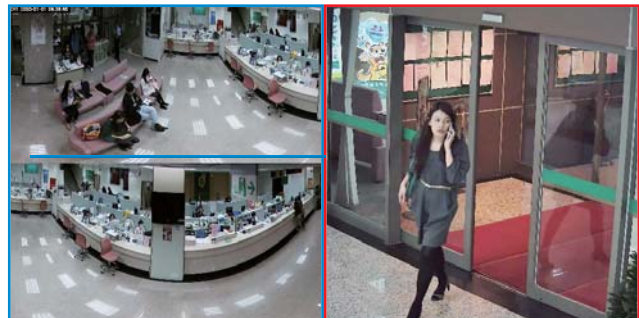

180° Panoramic View + Fixed-focal View

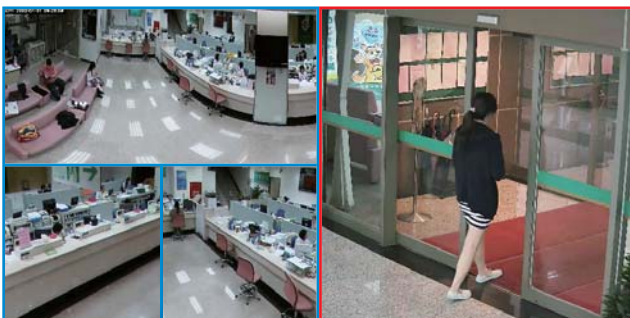

180° Triple View + Fixed-focal View



Quad View + Fixed-focal View



# 5. MQTT I/O Module

MQ-7200M is an I/O module designed for Internet of Things. It support MQTT V3.1 client. Through the MQTT broker (can be installed on private cloud or public cloud), it can flexibly exchange data between I/O modules and other MQTT clients.

Compared to request/response type of Ethernet I/O modules, MQTT I/O modules bring two obvious benefits:

### 1. Reduce the Ethernet communication packets

The behavior of most request/response type of Ethernet I/O modules is: the master polls every modules periodically no matter the data is changed or not. MQTT I/O modules can be configured to publish data to the broker periodically or an event happens. Thus the Ethernet communication packets can be obviously reduced.

### 2. Simplify the network configuration

MQTT I/O modules can be configured as dynamic IP address. Only the MQTT broker needs a domain name or a static IP address. Thus the networking configuration for each MQTT I/O module can be the same. Thus the configuring work becomes simplified.

## Features:

- Support MQTT V3.1 Client Point
- Built-in Web Server for Configuration
- 2-port Ethernet Switch for Daisy-chain Topology
- LAN Bypass to Prevent Communication Lost While Power Lost
- Build-in LED indicators for I/O

## Appearance:

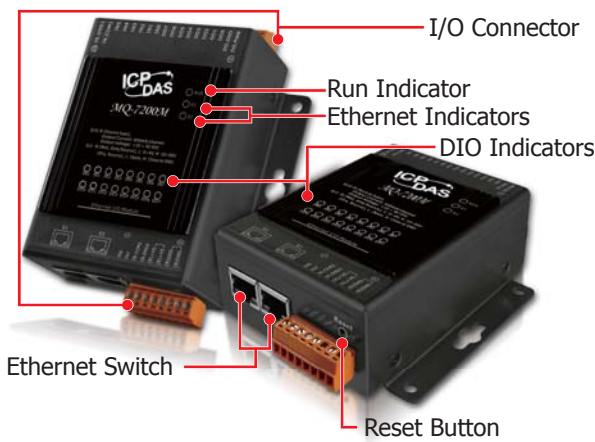

## Applications:

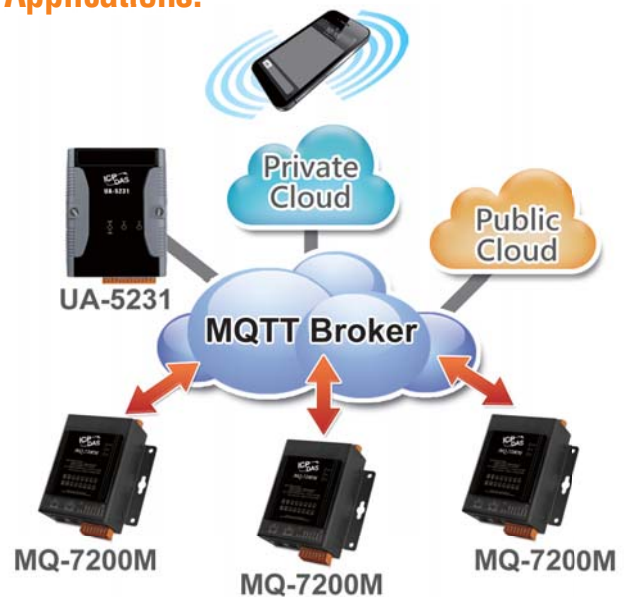

## Selection Guide:

Module Name	DI			DO			
	Channel	Type	Sink/Source	Channel	Type	Sink/Source	Max. Load
MQ-7244M	8	Wet	Sink/Source	8	Open Collector	Sink	300 mA/Channel
MQ-7251M	16	Wet	Sink/Source	-	-	-	-
MQ-7252M	8	Wet	Sink/Source	8	Open Collector	Source	650 mA/Channel
MQ-7253M	16	Dry	Source	-	-	-	-
MQ-7255M	8	Dry, Wet	Source	8	Open Collector	Source	650 mA/Channel
MQ-7258M	16	AC	Sink/Source	-	-	-	-

# 6. CL Series: Smart Environmental Monitoring



Fine particulate matter (PM2.5), gas (CH4), HCHO, and CO affect human's health and safety. Monitoring the concentration of CH4, PM2.5 and CO can let people stay away from danger, enjoy a healthy life, reduce medical costs. CO2 is a reference for indoor air quality, the high concentrations of CO2 increase possibility to harm people's health. According to the report, controlling the concentration of CO2 in air conditioning equipment can save up to 50% of energy. The **CL-200 series** can detect CH4, HCHO, PM2.5, CO, CO2, Temperature, Humidity and Dew Point information. The Sensing Solutions suitable for the villa, public area, commercial space, green building, smart buildings, etc. A free Utility is included to allow configuration and display of data in a powerful chart format that can be exported to Excel. The CL series can be connected via various communication interfaces, meaning that the device can be easily integrated into existing HMI or SCADA systems, and easily maintain in a distributed control system.

- Transportation of Food or Pharmaceuticals
- Food and Beverage Industry (HACCP)
- Blood Stations and Pharmacies
- Building and Energy Management
- Warehouse Management
- Museums, Archives and Galleries



## Selection Guide:

Model	Sensor							Interface	
	HCHO	CH4	PM2.5	CO	CO2	Temperature	Humidity		
CL-211	-	-	Yes	Yes	-	Yes	Yes	RS-485	
CL-212				-	Yes				Ethernet, PoE
CL-213				Yes	-				
CL-211-E				-	Yes			Ethernet + Bluetooth	
CL-212-E				-	Yes				
CL-213-E				Yes	-			Ethernet + Wi-Fi	
CL-211-BLE				-	Yes				
CL-212-BLE				Yes	-			CAN + ZigBee	
CL-213-BLE				-	Yes				
CL-211-WF				Yes	-				
CL-212-WF				-	Yes			CAN + ZigBee	
CL-213-WF				Yes	-				
CL-207-WF				Yes	-				-
CL-209-ZB	-	Yes	-	-	-	-	-	CAN + ZigBee	



# CL Series: Industrial Environmental Sensor

**CL-207/211/212/213**

**CL-209**

**CH4 Methane Gas Detector**

**HCHO  
PM2.5  
CO/CO2  
Temperature  
Humidity  
Dew Point**



The **CL-200 series** can be used to record HCHO, CH4, PM2.5, CO, CO2, Temperature, Humidity and Dew Point information, including date and time stamps, and can store up to 450,000 downloadable records. Real-time data can be accessed from the free Utility from anywhere and anytime using the free Windows software.

The CH4 methane (the main element of natural gas, different from the liquid petroleum gas) gas detector provides an early residential warning of the presence of explosive methane and is factory calibrated to sound an alarm that meets UL1484 standard.

Formaldehyde (HCHO) is one of the volatile organic compounds (VOCs) that widely used in household materials, be a binder precursor, which associated with many health risk factors. At concentrations above 0.1 ppm in air formaldehyde can irritate the eyes, resulting in watery eyes. The HCHO detector also provides an instantaneously warning of toxic formaldehyde.

**Free and Power Utility Software**

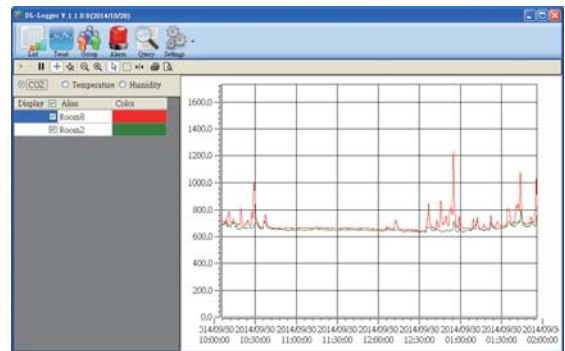

Models	CL-211	CL-212	CL-213	CL-207-WF	CL-209-ZB
Sensor Type	PM2.5/CO	PM2.5/CO2	PM2.5/CO/CO2	HCHO	CH4 (Gas)
	Temperature / Relative Humidity / Dew Point				-
PM2.5	Range: 0 ~ 400 µg/m3; Resolution: 1µg/m3; Response Time: <= 1 min.			-	-
CO	0 ~ 1000 ppm	-	0 ~ 1000 ppm	-	-
CO2	-	0 to 9999 ppm (NDIR)		-	-
HCHO	-	-	-	0 ~ 5 ppm	-
CH4	-	-	-	-	500 ~ 7000 PPM
Temperature	Range: -10 ~ 50°C / Accuracy: ±0.6°C / Resolution: 0.1°C				-
Humidity	Range: 0 ~ 100% RH / Accuracy: ±5% RH / Resolution: 0.1% RH				-
Dew Point	Range: Calculated using temperature and relative humidity / Resolution: 0.1°C				-
Data Logger	Up to 450,000 records				-
Communication	RS-485 (DCON and Modbus RTU)			Ethernet + Wi-Fi	CAN + ZigBee
Advantage	Support HCHO, CH4, PM2.5, CO, CO2, Temperature & Humidity Alarm Functions				

## Installation: CL-207/211/212/213:

### ■ Ceiling Mounting

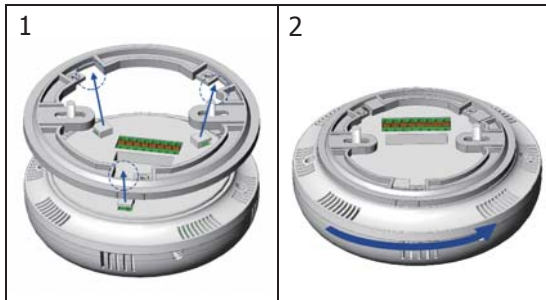

### ■ Wall Mounting (+ External Wall Box EWB-C150)

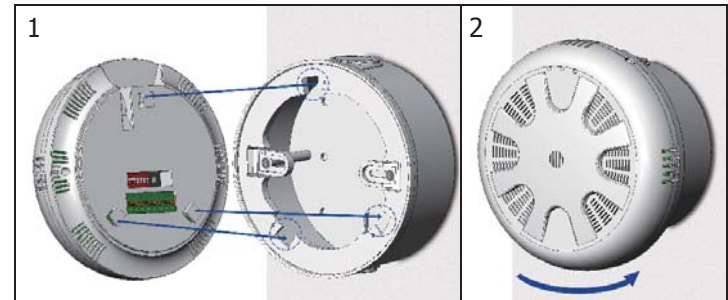

## Installation: CL-209:

### ■ Ceiling Mounting

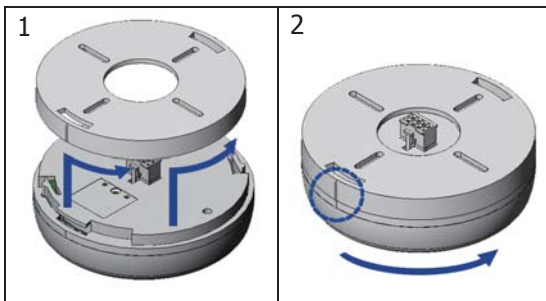

### ■ Wall Mounting (+ 86 Cartridge)

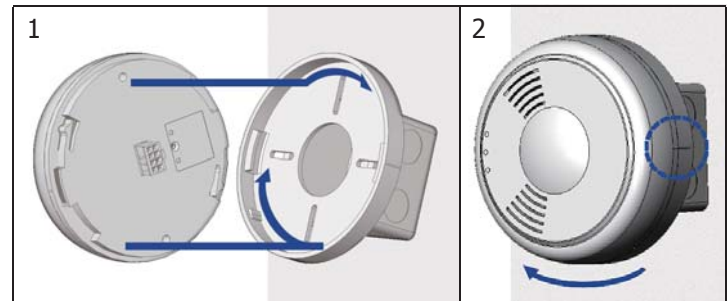

## Applications:

### ■ HCHO (Formaldehyde) Detector Automatic Solution

The HCHO detector provides an instantaneously warning of toxic formaldehyde, which can be found in a plywood factory, furniture factory and new interior remodelling house commonly.

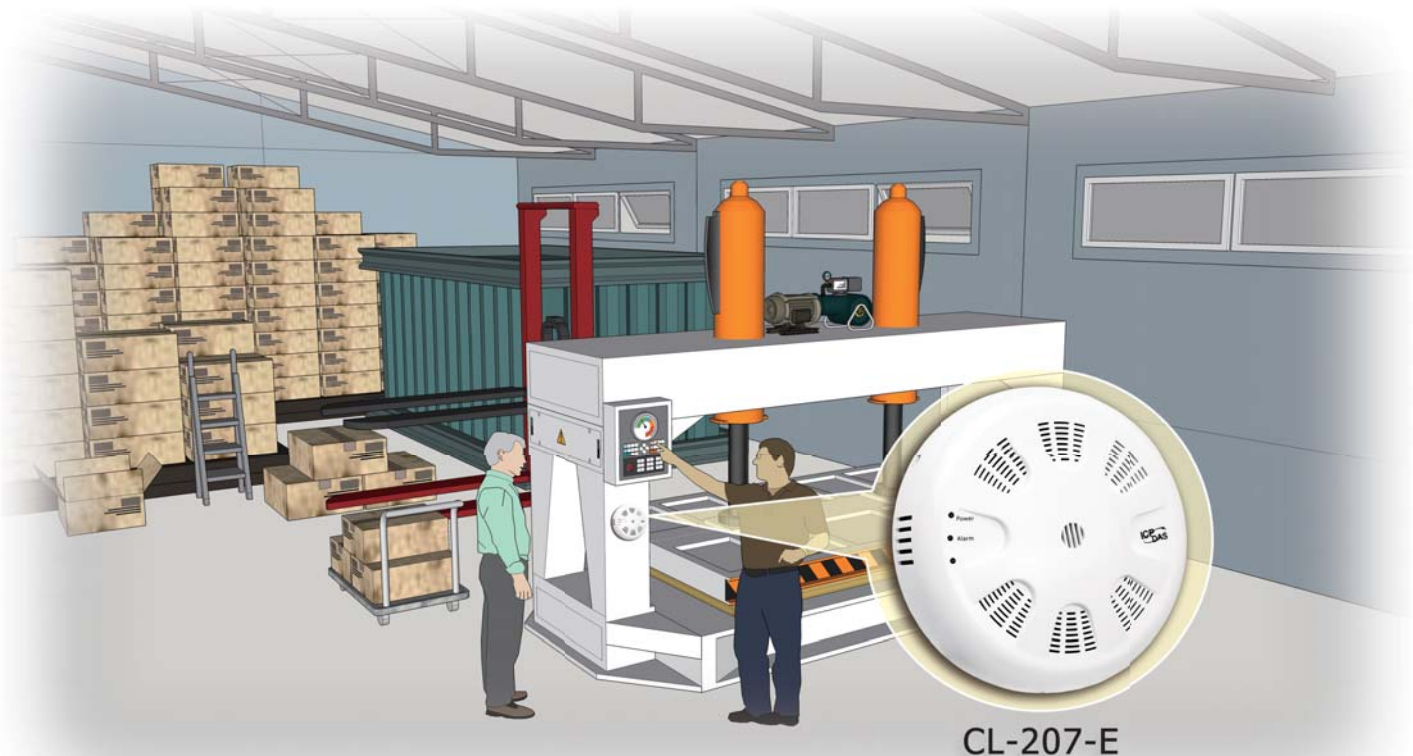

CL-207-E



# 7. DL Series: Smart Environmental Monitoring

CO / CO2 / HCHO / Temperature / Humidity / Dew Point

## Greenhouse Automation

**4 Communication Interface Options**

- Ethernet
- RS-485
- Wi-Fi
- BLE

**DL-302-IP65**      **DL-100**

**DL-100**      **DL-300**

The **DL series** of Data Logger devices provide RS-485, Ethernet/PoE, USB, WiFi and BLE communication interface for smart environmental monitoring. The DL-300 series can be used to record CO, CO2, HCHO, Temperature, Humidity and Dew Point information, including date and time stamps, and are able to store up to 450,000 downloadable records. Real-time data can be accessed from the DL-300 Data Logger from anywhere and at any time using the free Windows software, the iOS App or the Android App, as long as they are connected to the same local network as the Data Logger. The DL-100 series is a temperature and humidity data logger module. It contains an RS-485, Ethernet/PoE or USB communication interface and an LCD display to show a variety of temperature, humidity and module ID data. The data storage memory can store up to 4088 temperature and humidity records.

A free Utility is included to allow configuration and display of data in a powerful chart format that can export to Excel. The Sensing Solutions suitable for the villa, public area, commercial space, green building, smart buildings, etc.

The IP65 version of DL series is designed for industrial applications in harsh environments that provides IP65 grade protection approval . The rugged RJ-45 ensures tight, robust connections, and guarantees reliable operation, even for applications that are subject to high vibration and shock.



## Selection Guide:

DL-10/DL-100 Series (Temperature/Humidity)							
Model	Accuracy	2DO	Interface	Protocol	IP66	Color	
DL-10	Standard Version (3% RH)	-	RS-485	Modbus RTU	No	White Cover	
DL-100T485	Standard Version (3% RH)	-		DCON	Yes	Black Cover	
DL-100T485-W				Modbus RTU		White Cover	
DL-100TM485				DCON		Black Cover	
DL-100TM485-W				Modbus RTU		White Cover	
DL-100T485P	P Version (1.8% RH)	-		DCON		Black Cover	
DL-100T485P-W				Modbus RTU		White Cover	
DL-100TM485P				Modbus RTU		Black Cover	
DL-100TM485P-W				Modbus RTU		White Cover	
DL-100-E	Standard Version (3% RH)	-		Ethernet/PoE		Modbus TCP, MQTT	-
DL-100-E-W		Yes	White Cover				
DL-101-E			Black Cover				
DL-101-E-W		White Cover					
DL-100-USB	Standard Version (3% RH)	-	USB	Modbus RTU	-	Black Cover	
DL-100-USB-W		White Cover					
DL-100TMZT	Standard Version (3% RH)	-	ZigBee	Modbus RTU	-	Black Cover	

DL-300 Series (CO/CO2/HCHO/Temperature/Humidity)							
Model	Sensor					Interface	IP65
	CO	CO2	HCHO	Temperature	Humidity		
DL-301	Yes	-	-	Yes	Yes	RS-485 × 1 Ethernet/PoE × 1	No
DL-302	-	Yes	-				
DL-303	Yes		-				
DL-307	-	-	Yes				
DL-301-BLE	Yes	-	-				
DL-302-BLE	-	Yes	-				
DL-303-BLE	Yes		-			-	
DL-307-BLE	-	-	Yes				
DL-301-WF	Yes	-	-				
DL-302-WF	-	Yes	-				
DL-303-WF	Yes		-			-	
DL-307-WF	-	-	Yes				
DL-301-IP65	Yes	-	-				
DL-302-IP65	-	Yes	-				
DL-303-IP65	Yes		-			-	
DL-307-IP65	-	-	Yes				
DL-301-BLE-IP65	Yes	-	-				
DL-302-BLE-IP65	-	Yes	-				
DL-303-BLE-IP65	Yes		-			-	
DL-307-BLE-IP65	-	-	Yes				
DL-301-WF-IP65	Yes	-	-				
DL-302-WF-IP65	-	Yes	-				
DL-303-WF-IP65	Yes		-	-			
DL-307-WF-IP65	-	-	Yes				

# DL Series: Industrial Data Logger



**DL-100**  
Temperature  
Humidity

**DL-10**



**DL-300**

**CO / CO2**  
**HCHO**  
Temperature  
Humidity



**DL-302-IP65**

DL Series supports for popular industrial protocols such as DCON, Modbus RTU, and Modbus TCP, as well as the emerging machine-to-machine (M2M) / IoT (Internet of Things) connectivity protocol – MQTT. The DL-300 Data Logger can connect by communication interfaces including RS-485, Ethernet and PoE, meaning that the device can integrate easily into existing HMI or SCADA systems, and easy to maintain in a distributed control system.

■ Large 2.8" LCD Touch Screen, with clear Color Chart to indicate the CO/CO2 Level

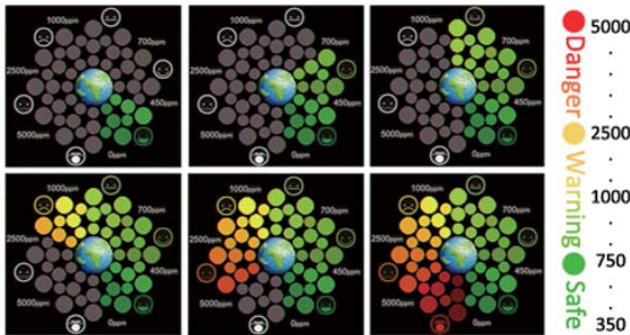

■ Free and Power DL300 Utility Software

The DL300 Utility can be used to configure the modules, monitor real-time data, group DL-300 modules so that the status of distribution groups can be viewed and managed. The utility also allows the log data to be downloaded and exported to a .CSV file that can then be imported into any industry-standard software or spread sheet for a analysis.

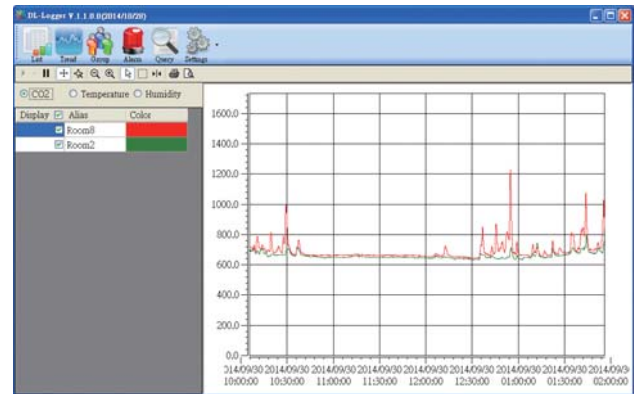

■ Supports the MQTT Protocol for IoT Applications

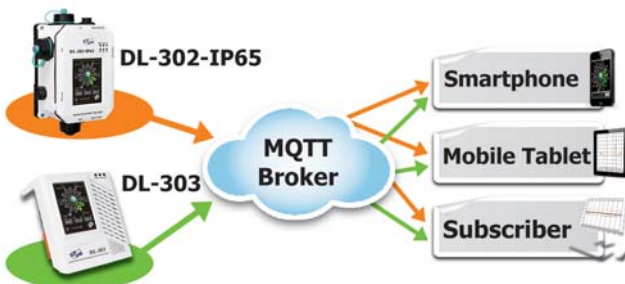

■ Multi-platform Remote Access Software

Real-time data from the DL-300 Data Logger can be accessed from anywhere and at any time using the DL300 Utility, the iOS or Android App, or via a regular web browser, as long as they are connected to the same local network as the Data Logger.

■ Display Messages in Multiple Languages

The display-message-on-screen function supports multiple language character sets based on UTF-8 encoding. Either pre-configured messages or dynamic messages can be remotely displayed using Modbus commands, or a dynamic message can be sent via the web-based interface.



Models	DL-10	DL-100	DL-301	DL-302	DL-303	DL-307
Sensor Type	-	-	CO	CO2	CO / CO2	HCHO
	Temperature / Relative Humidity		Temperature / Relative Humidity			
CO	-	-	0 ~ 1000 ppm	-	0 ~ 1000 ppm	-
CO2	-	-	-	0 to 9999 ppm (NDIR)		-
HCHO	-	-	-	-		0 ~ 5 ppm
Temperature Range/Accuracy	R: -20°C ~ +60°C A: ±0.4°C	R: -20°C ~ +60°C A: max. ±0.3°C	Range: 0°C ~ 50°C ( IP65 version support -20°C ~ 50°C ) Accuracy: ±0.6°C / Resolution: 0.1°C			
Humidity Range/Accuracy	R: 10 ~ 95% RH A: ±3% RH	R: 0 ~ 100% RH A: max. ±1.8% RH	Range: 0 ~ 100% RH Accuracy: ±5% RH / Resolution: 0.1% RH			
Dew Point	- Range: Calculated using temperature and relative humidity / Resolution: 0.1°C					
Data Logger	-	4088 Records	450,000 Records			
Communication	Modbus RTU	RS-485 / ZigBee / Ethernet / PoE / USB DCON or Modbus RTU	RS-485 / Ethernet / PoE / BLE / WiFi DCON, Modbus RTU, Modbus TCP and MQTT			
Display	-	Monochrome LCD	2.8" TFT Color LCD Touch Screen (Resolution 240 × 320 × 16)			
Advantage	Tiny	Tiny, Waterproof Level IP66	Support MQTT, Mobile APP, Alarm Functions			
IP65 Version	No	Yes	Yes, for IP65 version only			

### Appearance:

DL-100T485 Series



DL-100-E



DL-101-E



DL-10

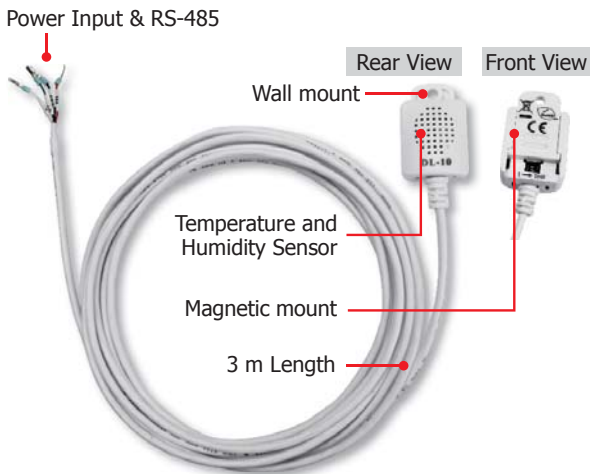

DL-302-IP65

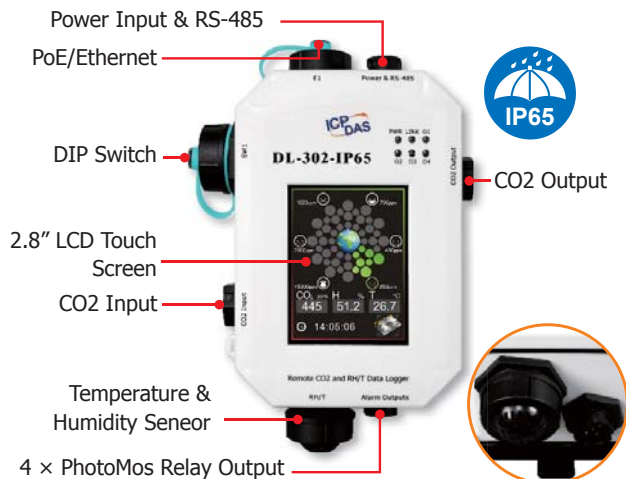



## HCHO (Formaldehyde) Detector Automatic Solution

The DL-307 is a 1-ch HCHO detector with data logger that provides an instantaneously warning of toxic formaldehyde, which can be found in a plywood factory, furniture factory and new interior remodelling house commonly. Real-time data can be accessed from the DL-307 from anywhere and at any time using the free Windows software, the iOS App or the Android App.



## Mushroom Farm

Mushroom growth yield requires long time to monitor the environment of CO<sub>2</sub> concentration, temperature and humidity values, and its growth environment is high humidity condition. The general equipment cannot work in such environment, but the DL-302-IP65 can be used to record CO<sub>2</sub>, temperature, humidity and dew point information with date and time stamps in the operating temperature from -20°C to +50°C, and are able to store up to 450,000 downloadable records. The WISE-5231-3GWA features timer and schedule functions. It allows user to schedule specific date or time for control logic execution, or perform specific tasks such as time delay. With calendar user interface provided, schedule setting can be more efficient and flexible. This does not require programming, only some simple settings will be able to achieve the farm production control and quality control, production resume ... and so on.

**DL-302-IP65**

**WISE-5231-3GWA**

IP65

CO<sub>2</sub>

Temperature

Humidity

SMS

Schedule Setting

Advanced Settings | Scheduler Setting | Schedule Schedule 1 Setting

Internal Register Setting

Timer Setting

Schedule Setting

Email Setting

SNMP Trap Setting

CGI Command Setting

Active I/O Setting

Channel Status Setting

Schedule Schedule 1 Setting

\*Nickname: Schedule 1

Description:

Schedule Content Setting

Mode: Calendar Repeat

Date: Starting Month: 2017 February

Duration: 1 Month(s)

\*Time Range(s): 08:30:00 - 17:30:00

Select All | Unselect All | Select Weekday | Select Workday

Sun	Mon	Tue	Wed	Thu	Fri	Sat
5	6	7	8	9	10	11
12	13	14	15	16	17	18
19	20	21	22	23	24	25
26	27	28				

OK Cancel

# 8. PIR/RPIR Series: Motion Detector

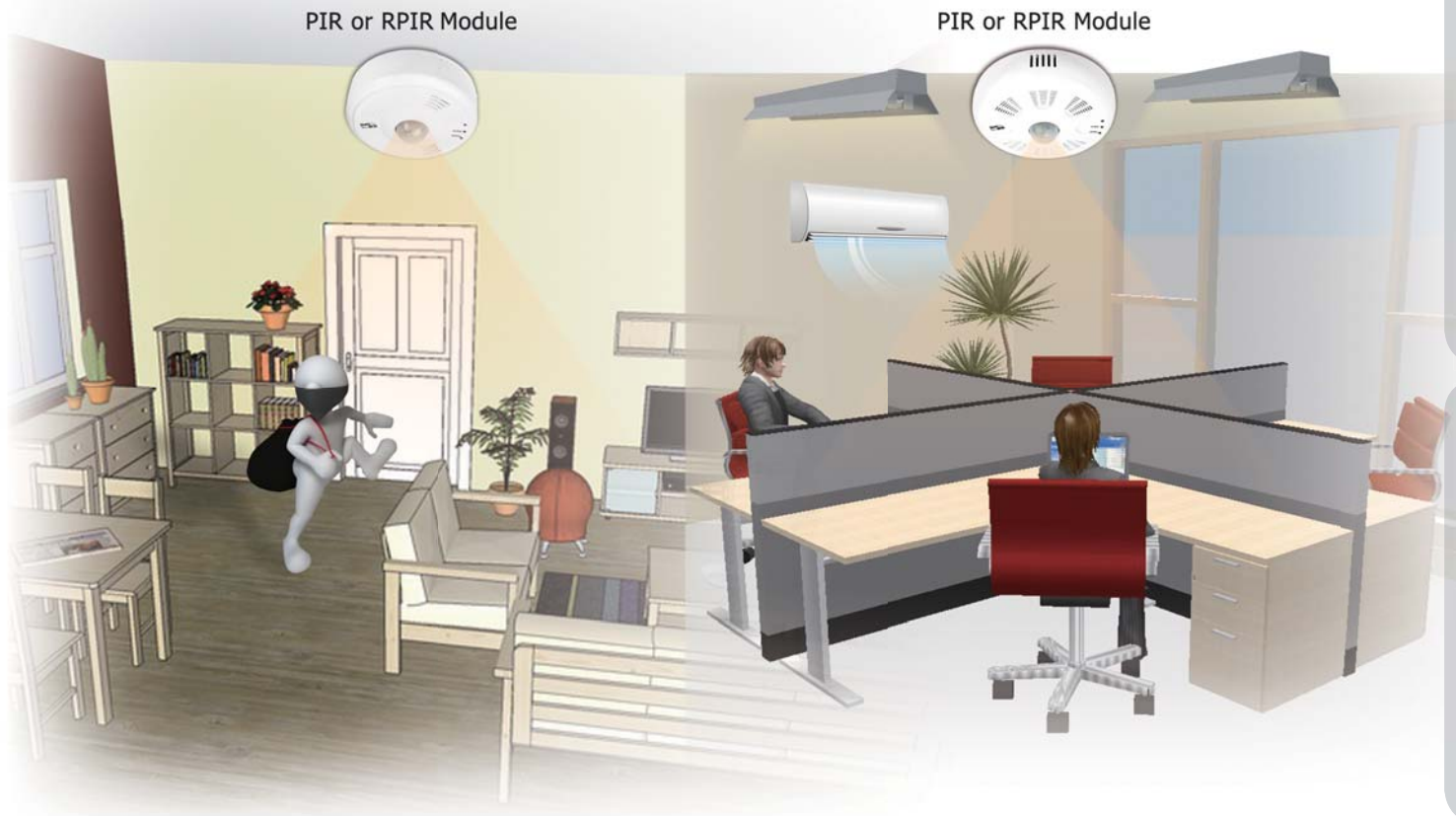

**PIR series**, the Passive Infrared series, provides human motion detection and temperature measurement; and **RPIR series** provides human motion detection, human presence detection, temperature and humidity and other environmental measurements. For the indoor human body sensing, anti-theft security, home quality of life, green energy and environmental protection and energy efficiency enhancement are very helpful. A free Utility is included to allow configuration and display of data in a powerful chart format that can be exported to Excel. The screw-free quick-connect connector, DIP switch and rotary switch make it easy to install, repair and maintain the product. White minimalist exterior design, easy to match with interior decoration. Considering the fireproof requirements, the casing is made of UL94-V2 rated material.

## Selection Guide:

Model	Motion Sensor	T&R Sensor	Protocol	Interface	Dimensions
PIR-130-AC	PIR	Temperature	DCON/Modbus RTU	RS-485	Ø 121 mm × 52 mm
PIR-130-DC				RS-485	
RAD-130-AC	Microwave		DCON/Modbus RTU	RS-485	
RAD-130-DC			DCON/Modbus RTU	ZigBee	
PIR-130-ZT	PIR	Temperature + Humidity	Modbus TCP, MQTT	Ethernet, PoE	Ø 150 mm × 53 mm
PIR-230-E			Modbus RTU	Bluetooth	
PIR-230-BLE			Modbus TCP	Wi-Fi	
PIR-230-WF	Microwave + PIR		Modbus TCP, MQTT	Ethernet, PoE	
RPIR-230-E			Modbus RTU	Bluetooth	
RPIR-230-WF			Modbus TCP	Wi-Fi	

1 PAC Products and BoxPC

2 Panel Products

3 Remote I/O Module and Unit

4 IIoT



# PIR-230/RPIR-230 Series

## Microwave Motion Sensor PIR Motion Sensor Temperature/Humidity Sensor



The **PIR series** can detect infrared waves generated by human within a range of approximately 8 meters in diameter with a 360° coverage area for indoor motion detection, and can be configured to auto-switch on a light if the motion is detected. It also has a temperature sensor for measuring room temperature or can be set up to activate a fire alarm. The **RPIR series** added the microwave detection technology is especially suitable for BA applications. There are RS-485/ZigBee/Ethernet/Bluetooth/Wi-Fi models can be selected. Different models support DCON, Modbus RTU/TCP or MQTT protocol, and can integrate HMI/SCADA/central control system.

### Features:



- Time-Delay / Lux. / Sensitivity Adjustable
- Photo Sensor Inside for Smart Switch-on Control
- LED Indicator for PIR/Temperature Sensor
- The Temperature Sensor for Measuring Room Temperature or Fire Alarm
- Relay Output Can be Used to Control the Light Via the PIR/Temperature Sensor
- Up to 1500 W Incandescent and 300 W Fluorescent (T8) Loading Capability
- Multiple Communication Interfaces and Protocols
- Ceiling Surface Mount Design

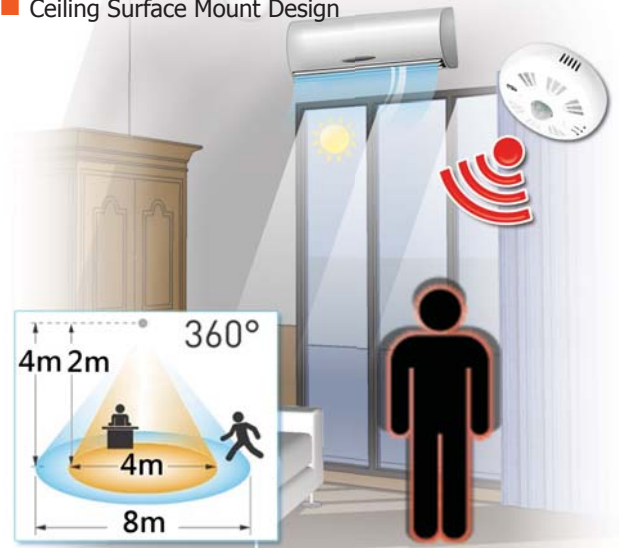

Models	PIR-230-E	PIR-230-BLE	PIR-230-WF	RPIR-230-E	RPIR-230-BLE	RPIR-230-WF
Sensor Type	PIR Motion Sensor Temperature / Humidity			Microwave/PIR Motion Sensor Temperature / Humidity		
<b>Passive Infrared (PIR) Motion Sensor / Microwave Motion Sensor</b>						
Time-delay	Hardware: 8-step Switch-selectable (sec) Software: 16-step (sec)			Hardware: 8-step Switch-selectable (sec) Software: 0 ~ 65535 (sec)		
LUX Control	Hardware: 2 mode (Dawn and dust) / Software: 5-step					
Detection Range	4 meters max.			PIR : 4 meters; Microwave: 2 meters		
Detection Field of View	PIR: 360°; Diameter 8 meters Max.			PIR: 360°; Diameter 8 meters Max.		
	Microwave: -			Microwave: -360°; Diameter 4 meters Max.		
<b>Temperature Sensor</b>						
Range	-40°C ~ +125°C					
Fire Alarm	65°C (Programmable)					
Measurement	Resolution: 0.1°C / Accuracy: ±0.6°C					
<b>Relative Humidity Measurement</b>						
Range	0 ~ 100% RH					
Measurement	Resolution: 0.1% RH / Accuracy: ±5% RH					
<b>I/O Channel</b>						
AC Digital Input	-			2		
Relay Output	1			1		
<b>Communication</b>						
Protocol	DCON, Modbus RTU, Modbus TCP, MQTT					
Wired Interface	Yes, RS-485 × 1 and Ethernet/PoE X1					
Wireless Interface	-	Bluetooth	Wi-Fi	-	Bluetooth	Wi-Fi



# 9. Bluetooth LE Gauge Master for Mitutoyo Gauges



**GAM-100**

## Features:



- Frequency: ISM 2.4 GHz
- Standard: Bluetooth 4.0
- Wireless transmission range up to 20 meters (Line of Sight)
- Fully compliant with the Mitutoyo ID-S1012MX/NTD-10-6" PMX
- LED indicators for Battery / RF link / Charge LEDs
- Support different transmission rate: 1/2/5/10 Hz
- Support Trigger button and 3.5 mm foot switch connector to log data
- Power by micro USB chargeable Li-ion battery
- Battery Usage Life: 100HR

## Introduction:

The GAM-100 is a Bluetooth Low Energy (Bluetooth LE/Bluetooth 4.0) gauge master for Mitutoyo gauges, with SPC output. A smart phone or tablet can use Bluetooth to get Mitutoyo gauge data through the gauge master. With the built-in micro USB chargeable Li-ion battery, the gauge master can work for 100 hours. To get and log the data, an Android APP is designed for a mobile device. The data can be kept in the local memory storage or uploaded to the remote MySQL server.

## Android APP:

- Provide device search function
- Display meter data in real-time graphics
- Battery remaining capacity display
- Support trigger mode configuration
- Upload data to remote MySQL server
- Provide recording file(\*.csv)

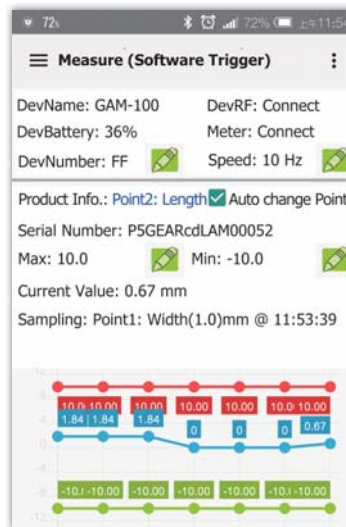

## Applications:



# 10. Stack Light Monitoring Module



**tSL-P4R1** (DC TYPE)      **tSL-PA4R1** (AC TYPE)

## Features:



- Able to detect the status of each color segment: ON, OFF, or Flashing
- 4-channel DC/AC digital input and 1-channel alarm relay output
- Status monitoring for user-defined combinations of multiple color segments
- Reports the duration of the previous status
- Supports Modbus RTU, Modbus TCP and MQTT protocols
- Includes RS-485/Ethernet communication interfaces
- Includes redundant power inputs: PoE (IEEE 802.3af, Class 1) and DC input
- Web-based configuration interface and firmware update via Ethernet
- Relay output for alarm devices
- Provides WiFi telemetry for SL-P6R1-WF and SL-PA6R1-WF
- Wide operating temperature range: -25 to +75°C

## Introduction:

The main purpose of managing machine status is to reduce the amount of downtime and to reduce production costs. The easiest way to achieve this is by installing a tSL-P4R1/tSL-PA4R1 intelligent module from ICPDAS, which monitors the output of the machine's indicators without affecting the operation of the equipment, thereby enabling the current operation stage of the machine to be mastered and ensuring timely command of the logistics system support in order to achieve production goals.

The tSL-P4R1/tSL-PA4R1 is a stack light monitoring module which includes 4-channel DC/AC digital input and 1-channel relay output that can be used to monitor the status of the stack light of the MES (Manufacturing Execution System) machine. The module can be used to detect the status of each color segment of the stack light as being either OFF, ON, or flashing. In addition to detecting the status of each individual color segment, the status of the combination of multiple color segments can also be defined, including the ability to report the duration of the previous status. By integrating the tSL-P4R1/tSL-PA4R1 module into your system, it is easy to implement stack light status monitoring on an MES via SCADA software to improve machine utilization and throughput.

## Selection Guide:

Stack Light Monitoring Module								
Model	Digital Input		Alarm Output		Interface			
	Channel	Type	Channel	Type	RS-485	Ethernet/PoE	WiFi	
tSL-P4R1	4	DC	1	Power Relay, Form A (SPST)	1	1	-	
tSL-PA4R1		AC						
▶SL-P6R1-WF	6	DC			1	1	1	1
▶SL-PA6R1-WF		AC						

Note: ▶ Available soon

## Wire Connections:

**tSL-P4R1**

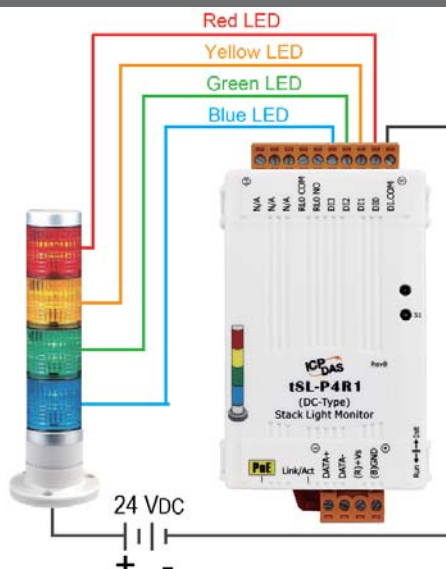

**tSL-PA4R1**

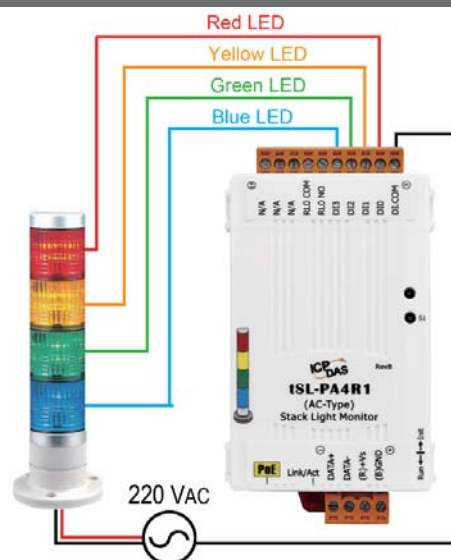

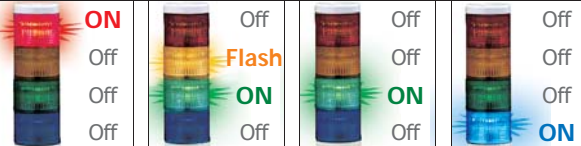
	ICP DAS Solution (tSL series)	Other company's solution
Interface	RS-485, Ethernet	RS-485, Ethernet
SCADA Integration	Modbus/RTU, Modbus/TCP	Modbus/RTU, Modbus/TCP
IIoT Integration	MQTT protocol. Push the data when the status changed, light Ethernet bandwidth loading.	RESTful protocol. Polling the status, heavy Ethernet bandwidth loading.
Stack Light (DC Type)	Yes	Yes
Stack Light (AC Type)	Yes	No (needs Relays to convert AC to DC)
On/Off Status Detections	Yes	Yes
Flashing Status Detections	Yes	No
MES, ERP Integration	Yes 1. Status for max. of 81 user-defined combinations of multiple color segments. For example:	No
		
	Status#1 (Error)    Status#2 (Wait)    Status#3 (Run)    Status#4... #81	
	2. Previous Status Duration Report Easy to calculate the machine utilization for MES, ERP.	

# Stack Light Monitoring Solution

Easy to implement stack light status monitoring on an MES to improve machine utilization and throughput.

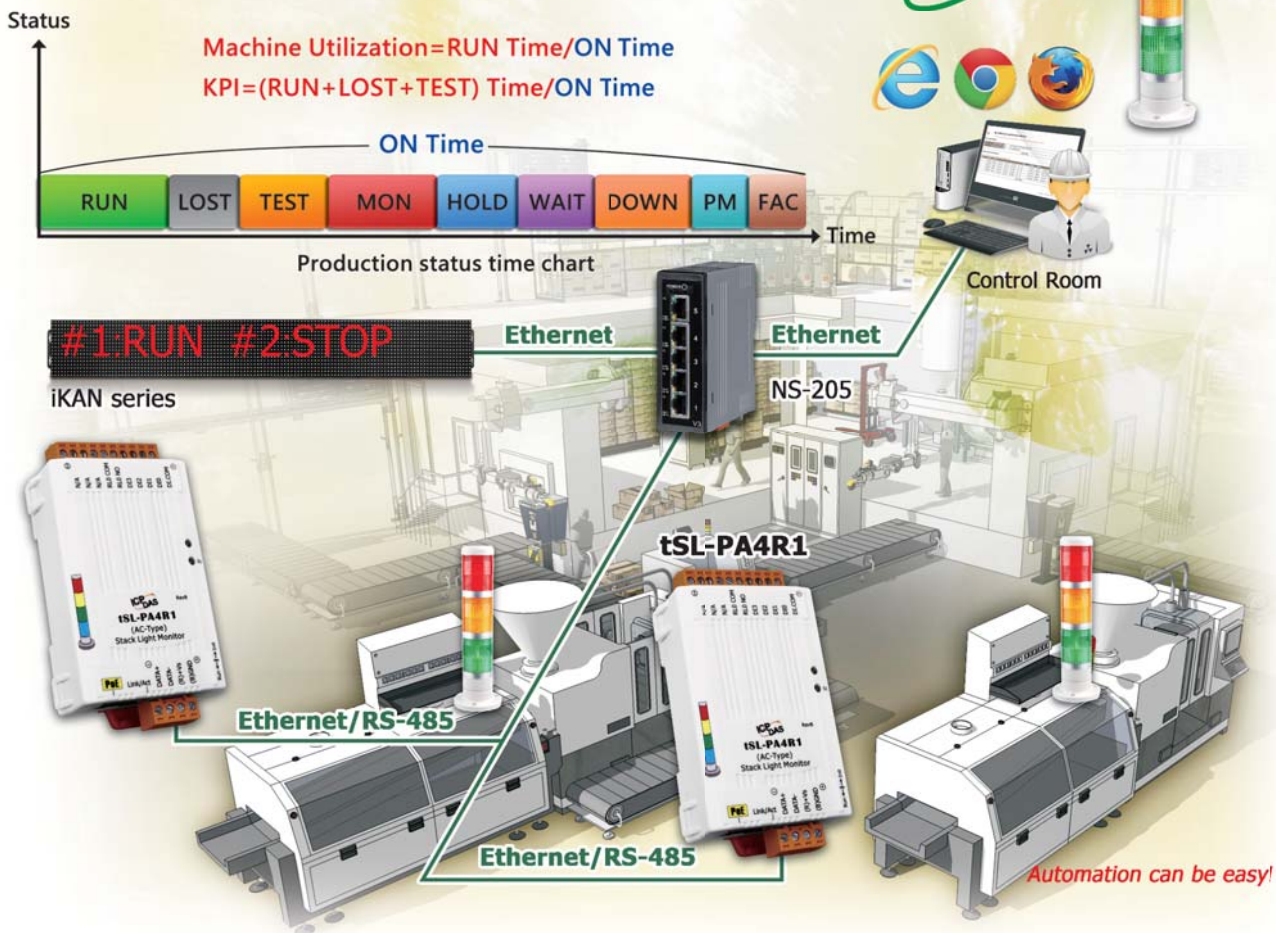



# 11. Accelerometer Data Logger Module



**AR-200**

**AR-400**

## Features:



- 2 or 4 simultaneous, 16-bit resolution ADC
- Support 2 or 4 IEPE input and built-in 3 mA excitation current
- AR-200 support sample rate: 200kHz, 100kHz, 50kHz
- AR-400 support sample rate: 125kHz, 100kHz, 50kHz
- Max. Recording time: 120 seconds
- Dynamic range:  $\pm 10V$
- Flexible trigger modes: Push button trigger, Schedule trigger, analog threshold trigger, digital input trigger and utility remote trigger
- Supports 4 to 32 GB micro SDHC flash card
- Provide LED indicators
- Wide range of power input (+10 ~ +30 Vdc) and operating temperature (-25 ~ +75°C)

## Introduction:

AR-200 / AR-400 is a high-performance dynamic signal acquisition module equipped with 2 / 4 analog input channels providing simultaneous-sampling at up to 200/125 kHz per channel. The module has a built-in 16-bit resolution ADC and 3 mA excitation current to measure IEPE sensors, and a micro SDHC flash card for data logging. It also supports flexible trigger modes, sampling rates, and recording time span, making it ideal for signal measurement in vibration applications.

## Utility:

- Provide device search function.
- Support trigger mode configuration
- Support RTC calibration
- Show system event log
- Support utility remote trigger mode
- Provide recording file(\*.ar) convert to various file type (\*.xls, \*.csv, \*.txt)

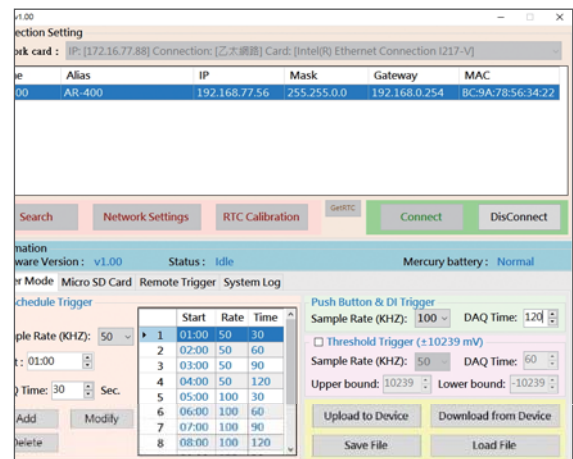

## Application:

### Vibration Signal Measurement



## 1 Multiport Serial Cards P 5-1

## 2 Serial Device Server P 5-2

- 2.1 Intelligent Serial-to-Ethernet Device Servers - - - - - P 5-5
- 2.2 Palm-size Programmable Serial-to-Ethernet Device Server - - - - - P 5-7
- 2.3 Palm-size Serial-to-Ethernet Device Server - - - - - P 5-9
- 2.4 IP67 Programmable Serial-to-Ethernet Device Server - - - - - P 5-10
- 2.5 Programmable Serial-to-Fiber Device Server - - - - - P 5-11
- 2.6 Tiny Serial-to-Ethernet Device Server & Modbus Gateway - - - - - P 5-12
- 2.7 Programmable Serial Device Server with LAN Switch - - - - - P 5-15
- 2.8 Programmable Modbus to Ethernet Gateway - - - - - P 5-16
- 2.9 Modbus Data Concentrator, MDC-700 series - - - - - P 5-17

## 3 Converter/Repeater/Hub/Splitter P 5-19

## 4 Termination Resistor/DC Bias Voltage P 5-21

## 5 Ethernet Switch P 5-22

## 6 Fieldbus Solution P 5-28

- 6.1 EtherNet/IP Gateways - - - - - P 5-28
- 6.2 BACnet Gateways - - - - - P 5-29
- 6.3 CAN Bus Repeater/Bridge/Switch - - - - - P 5-30
- 6.4 USB to CAN Converters - - - - - P 5-31
- 6.5 CAN to Fiber Converter/Bridge - - - - - P 5-31
- 6.6 Ethernet/Wi-Fi to CAN Converters - - - - - P 5-32
- 6.7 Uart to CAN Converters - - - - - P 5-34
- 6.8 CANopen Gateways - - - - - P 5-35
- 6.9 DeviceNet Gateways - - - - - P 5-36
- 6.10 J1939 Gateways - - - - - P 5-37
- 6.11 CAN Bus Data Logger - - - - - P 5-38
- 6.12 PC-based CAN Bus Boards - - - - - P 5-40
- 6.13 Palm-size Programmable CAN Controllers - - - - - P 5-43
- 6.14 PAC-based CAN Modules - - - - - P 5-44
- 6.15 PROFIBUS Converters & Gateways - - - - - P 5-45
- 6.16 PROFINET Converters & Gateways - - - - - P 5-47
- 6.17 HART Converters, Gateways & Signal Filter - - - - - P 5-48
- 6.18 M-Bus Converters & Gateways - - - - - P 5-51

# 1. Multiport Serial Cards

## Overview:

The VXC/VEX multiport card is the foremost choice for PC-based communication solutions, ensuring smooth communication in both time-critical applications and industrial fields. Installing a VXC/VEX multiport card increases the number of serial ports available on the PC, meaning that it is much easier to integrate a PC with a large number of external devices, such as PLCs, meters, controllers, laboratory instruments, modems, card readers, serial printers, RFID readers, bar code readers, and sensors, etc.



## Selection Guide:

### ✓ PCI Express

Model Name	COM-Selector	RS-232	RS-422/485	Self-Tuner	Isolation (VDC)	ESD Protection	Max. Speed (bps)	FIFO Size (bytes)	Connector
VEX-112	Yes	2	–	–	–	–	115.2 k	128	Male DB-9
VEX-112i	Yes	2	–	–	2.5 k	±4 kV	115.2 k	128	Male DB-9
VEX-142	Yes	–	2	Yes	–	–	115.2 k	128	Male DB-9
VEX-142i	Yes	–	2	Yes	2.5 k	±4 kV	115.2 k	128	Male DB-9
VEX-114	Yes	4	–	–	–	–	115.2 k	128	Female DB-37
VEX-114i	Yes	4	–	–	2.5 k	±4 kV	115.2 k	128	Female DB-37
VEX-144	Yes	–	4	Yes	–	–	115.2 k	128	Female DB-37
VEX-144i	Yes	–	4	Yes	2.5 k	±4 kV	115.2 k	128	Female DB-37
PCIe-S118	–	8	–	–	–	–	921.6 K	256	Female DB-62
PCIe-S148	–	–	8	Yes	–	–	921.6 K	256	Female DB-62

### ✓ Universal PCI

Model Name	COM-Selector	RS-232	RS-422/485	Self-Tuner	Isolation (VDC)	ESD Protection	Max. Speed (bps)	FIFO Size (bytes)	Connector
VXC-112AU	Yes	2	–	–	–	–	115.2 k	128	Male DB-9
VXC-112iAU	Yes	2	–	–	2.5 k	±4 kV	115.2 k	128	Male DB-9
VXC-142AU	Yes	–	2	Yes	–	–	115.2 k	128	Male DB-9
VXC-142iAU	Yes	–	2	Yes	2.5 k	±4 kV	115.2 k	128	Male DB-9
VXC-182iAU	Yes	1	1	Yes	2.5 k	±4 kV	115.2 k	128	Male DB-9
VXC-114U	Yes	4	–	–	–	–	115.2 k	128	Female DB-37
VXC-114iAU	Yes	4	–	–	2.5 k	±4 kV	115.2 k	128	Female DB-37
VXC-144U	Yes	–	4	Yes	–	–	115.2 k	128	Female DB-37
VXC-144iU	Yes	–	4	Yes	2.5 k	±4 kV	115.2 k	128	Female DB-37
VXC-118U	–	8	–	–	–	–	115.2 k	256	Female DB-62
VXC-148U	–	–	8	Yes	–	–	115.2 k	256	Female DB-62

## Optional Accessories:

CA-0910F		9-Pin Female-Female D-Sub Cable 1 m	CA-9-3715D		Male DB-37 to 4-port Male DB-9 Cable, 1.5 M (180°)
CA-0915		9-Pin Male-Female D-Sub Cable, 1.5 m	CA-9-3705		Male DB-37 to 4-port Male DB-9 Cable, 0.3 M (90°)
CA-PC09F		9-Pin Female D-Sub Connector with Plastic Cover	CA-9-6210		Male DB-62 to 8-port Male DB-9 Cable, 1.0 M
CA-4002		37-Pin Male D-Sub Connector with Plastic Cover	DN-09-2F		I/O Connector Block with DIN-Rail Mounting and Two 9-Pin Male Header. Includes CA-0910F x 2 (9-Pin Female-Female D-Sub Cable 1 m)



# 2. Serial Device Server

## Overview:

The ICP DAS Programmable Device Server is designed to bring network connectivity to your serial devices. The programmable features allow developers to quickly build custom applications that turn "dull" serial devices into "intelligent" devices right away without modifying their hardware or software configuration.

With extensive experience accumulated over many years, a great number of serial devices such as PLCs, bar code readers, RFID readers, meters and motion controllers, etc., have been widely used in various applications. As the advances in communication technologies in recent years, continue to drive optimization of data accessibility and remote operation ability, a wide variety of industries have begun to feel the urge to upgrade their latency serial communications to Ethernet network connections. The ICP DAS PDS series of products are your best choice for implementing this scenario in a robust, reliable and cost-effective way.



**VxComm** driver & utility  
Where remote serial devices become part of your PC

The VxComm Driver creates virtual COM port(s) on 32-bit and 64-bit Windows XP/2012/7/10 systems and maps them to the remote serial port(s) of the PDS/DS series. The user's serial client programs need to only be changed to the virtual COM port access the serial devices that are allocated on the Internet or Ethernet network via the PDS/DS series.

## Easy Serial Device Networking with "transparency"

The most intuitive and easiest way to remotely control serial devices is to access those devices transparently via a network with no software modification required. The ICP DAS PDS product line offers two transparent applications:

### ▪ Socket Connections:

Using a TCP/IP socket connection, client programs can exchange information with specific PDS/DS serial ports and talk to serial devices directly. For example, simply create a socket connection to the TCP/IP port 10001 (default) of the PDS/DS device and you can then access Port1 of the PDS/DS remotely. This is an OS-independent method and works well on most OS (operating systems) that provide socket functions.

### ▪ Virtual COM Ports:

ICP DAS developed a specific function called "Virtual COM" that simulates PDS serial ports as fixed PC COM ports. Virtual COM ports appear to the system and applications as real ports. Once established, users can immediately enjoy the convenience that networking provides.



## DynaCOM Technology

ICP DAS Virtual COM also supports an exclusive function - Dynamic Virtual COM Mapping (DynaCOM); if the system can only access limited or fixed numbers of COM Ports, specific PDS serial ports can be dynamically assigned to the corresponding COM port numbers.

### Programmable Enhanced "Device Servers"

The programmable features of the PDS series of products makes it possible to effectively implement exclusive protocols and exclusive communication mechanisms for complex PDS-based applications. This provides the following advantages:

▪ **Effective network transmission:**

Place your customized software on the PDS to directly perform processes locally. The effective data and information can be periodically sent back to the PC based on a schedule that can be planned in advance and the devices will work independently on-site, even when not connected to a network. Therefore, the design of system can be much more flexible. This also reduces the need to rely on the network, which is an inevitable factor for conventional DS (Device Server) as it has to keep on "talking" to the PC via the network to ensure the status maintains transparency.

▪ **Previous development efforts can be duplicated:**

Along with serial devices, you can place your customized or value-added software on the PDS to implement an intelligent Ethernet controller. This controller can then be used in applications for future projects, dramatically reducing programming requirements. In addition, your value-added software is embedded in the PDS, so if a computer system undergoes hardware replacement or upgrade, incompatibility issues don't need to be considered, which therefore reduces system maintenance work.

### Virtual I/O Highly Integrates On-Site Messages

I/O acquisition is very important when performing on-site integration. The RS-485 port of PDS is able to be connected to I/O devices, like I-7000/M-7000 series, to offer abundant I/O functions for various purposes. For easier on-site integration, some PDS models also provide Digital I/O, which is also supported by the ICP DAS DCON utility, EZ Data Logger or other DCON client programs.

### ESD Protection and Frame Ground

The PDS series offers TVS diode ESD protection technology with a frame ground design that protects your system from being damaged by high potential voltages.

Under normal operating conditions, the TVS diode presents high impedance (appears as an open circuit) to the protected component. If the voltage exceeds the limitation, the TVS diode avalanches, providing a low impedance path for the transient current. As a result, the transient current is diverted away from the protected components and shunted through the TVS diode. The device returns to a high impedance state after the transient threat has passed.

### Self-Tuner Inside

The PDS series is equipped with a "Self-Tuner" chip that automatically controls the sending/receiving direction of the RS-485 ports. Without the presence of Self-Tuner, users need to enable the RS-485 transmitter before transmitting, and disable the transmitter after the transmission is complete. The time required to enable and disable the transmitter (direction control) is the major source of many communication issues, and it is very difficult to debug. The built-in Self-Tuner in the PDS effectively removes this direction control issue and also simplifies the software/firmware programming required for communication applications.

### Easy Web Configuration

The PDS also contains a built-in web server that enables users to conveniently configure the PDS. A web browser, like IE or Firefox, can be used to connect to the PDS to modify the configuration, such as: IP address, subnet mask, gateway, DHCP client, UDP search, Web Server, Telnet Server, TCP ACK delay, Watchdog timeout, Master IP, Filter IP, COM port baud rate, data format and transfer mode, etc.

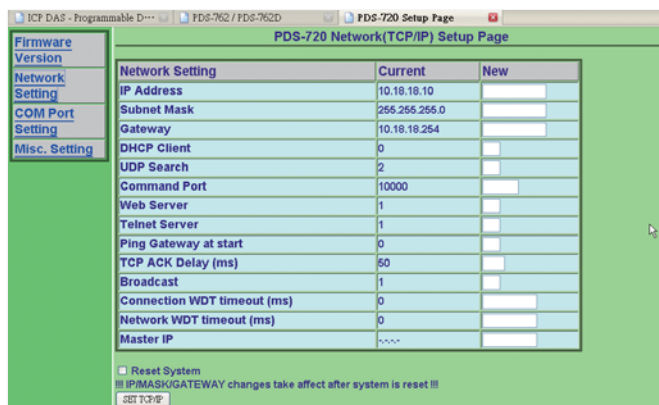

### Master IP and Filter IP (White List)





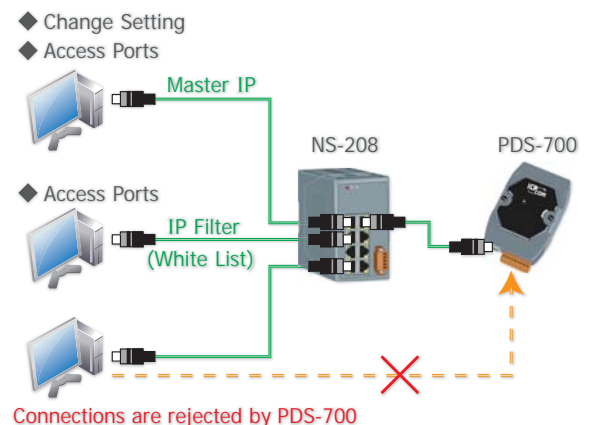

The PDS can use a master IP setting that allows a client to configure the PDS and COM ports. This prevents the configuration of the PDS and COM ports from being changed by other clients.

The IP filter setting limits which client PCs are able to access the PDS module via specific IP addresses. Connections from other clients will be rejected by the PDS.





## Selection Guide:



### Comparison Table of Device Server and Modbus Gateway

Features	iDS	PPDS	PDS	DS	tDS	tGW
Picture						
PoE	Yes	Yes	–	–	Yes	Yes
Programmable	Yes	Yes	Yes	–	–	–
Virtual COM	Yes	Yes	Yes	Yes	Yes	–
Modbus Gateway	–	Yes	–	–	–	Yes
Multi-client	Yes	Yes	Yes	Yes	–	Yes
SNMP	Yes	–	–	–	–	–
Application Mode	Virtual COM TCP Server TCP Client UDP Pair Connection RFC2217 Telnet Modem Emulator	Virtual COM TCP Server TCP Client Pair Connection Modbus TCP Slave	Virtual COM TCP Server TCP Client Pair Connection	Virtual COM TCP Server TCP Client Pair Connection	Virtual COM TCP Server TCP Client Pair Connection	Modbus TCP Master Modbus TCP Slave Modbus UDP Master Modbus UDP Slave Pair Connection
Remarks	Intelligent	Professional	Powerful	Isolation for DS-715	Cost-effective, Entry-level	Cost-effective, Entry-level





#### iDS Series – Intelligent Device Server

Series	Ethernet	Virtual COM	Virtual I/O	Programmable	Modbus	Case
 iDS-700	10/100 M, PoE	Yes	–	Yes	Yes	Plastic
 iDS-700M						Metal



#### PPDS Series – Programmable Device Server and Modbus Gateway with PoE

Series	Ethernet	Virtual COM	Virtual I/O	Programmable	Modbus	Case
 PPDS-700-MTCP	10/100 M, PoE	Yes	Yes	Yes	Yes	Plastic
 PPDSM-700-MTCP						Metal
 PPDS-700-IP67			–		–	IP67 Waterproof Plastic

#### PDS Series – Programmable Device Server

Series	Ethernet	Virtual COM	Virtual I/O	Programmable	Modbus	Case
 PDS-700	10/100 M	Yes	Yes	Yes	–	Plastic
 PDSM-700						Metal
 PDS-220Fx	100 Base-FX, Fiber		–			–
 PDS-5000-MTCP	10/100 M Ethernet Switch	–	–	–	Yes	Plastic

#### DS, tDS & tGW Series – Non-Programmable Device Server and Modbus Gateway

Series	Ethernet	Virtual COM	Virtual I/O	Multi-client	Modbus	Casing	Remarks
 tDS-700	10/100 M, PoE	Yes	–	–	–	Plastic	Cost-effective
 tGW-700		–		Yes	Yes		



## 2.1 Intelligent Serial-to-Ethernet Device Servers

**iDS-700**

**iDS-400**

Intelligent Serial-to-Ethernet Device Servers



iDS-718-D

iDS-745M-T

iDS-448iM-D



### Features:

- Simple setup, factory floor devices can be connected to SCADA systems in minutes
- Serial Devices can be monitored and controlled via the Ethernet
- Supports 1/2/4-port RS-232, RS-422 and RS-485 communications
- Web-based configuration and PC Utility
- Supports RS-485 Data Direction Control with Self-Tuner Technology
- Provides Virtual COM (COM port redirection), TCP Server/Client (Max. 32 connections), UDP, Serial Tunnel (Pair connection), Modem Emulator, and RFC2217 application modes.
- Reset button for restoring the factory configuration
- Supports SNMP V1, V2c, V3, Trap and MIB-II protocols for network management
- Built-in Hardware-selectable Pull High/Low resistors and Terminal resistors for RS-422/485 ports
- Serial ESD protection
- Includes a Smart Ethernet Port that recognizes both straight and crossover Ethernet Cables
- Built-in Buzzer, RTC, and Watchdog
- RoHS Compliant
- Wide operating temperature range: -25 to +75°C

### Introduction:

#### Introducing the All-new Device Server

Cost, Performance and Reliability in Total Alignment



The iDS product range is the 3rd generation of Device Servers from ICP DAS. It is designed for rugged, industrial-level applications, and provides high performance, high reliability and high capacity.

The iDS product range provides a complete Ethernet service, as well as 1-, 2-, and 4-port RS-232/RS-422/RS-485 interfaces that allow any existing serial devices to be connected to an Ethernet network.

### Industry 4.0 is Coming

Serial-to-Ethernet services have become more critical than ever before

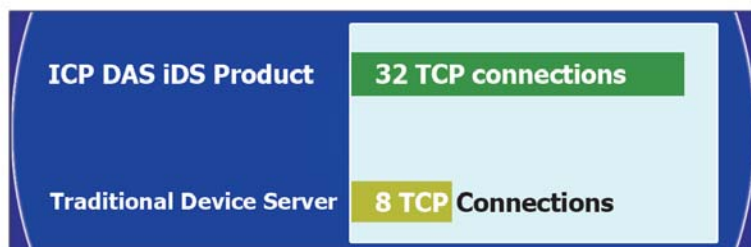

More connections mean greater connectivity for integration with the Internet of Things

### Taking the Long-term View

A comprehensive serial-to-Ethernet Service

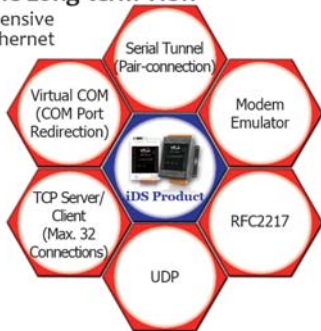

### We Know Time is Everything

Quick and Easy Installation



- 3-IN-1 COM PORT, RS-232/422/485
- Dual COM Port Selection Method (Hardware and Software)
- PoE and Daisy Chain Design
- Web Configuration and PC Utility

### Powerful Data Transparent Solution: Zero Data Loss

The iDS product range is equipped with an ARM-based high-performance CPU and large capacity RAM in order to accomplish the goal of "Zero Data Loss" when attempting to transfer a critical data stream. If a failure occurs on the Ethernet connection, the serial data will be queued and will be resent once the Ethernet is reconnected. Each device port provides 32 TCP connections that can be used to share the same information across the network from a single serial device.

### Industrial-grade Design

The iDS product range provides a wide range of built-in features designed for easy deployment of the device into existing operating environments.

1. Dual Power Supply: DC and PoE
2. DIN-Rail Mounting
3. Serial Port Surge Protection
4. Adjustable RS-485 Terminal Resistor and Pull High/Low Resistor
5. RS-485 Direction Control via the embedded ICP DAS Self-Tuner
6. Hardware/Software-selectable RS-232, RS-422 or RS-485 Interfaces
7. Hardware Reset button and LED Indicator.
8. 64-bit Hardware Serial Number

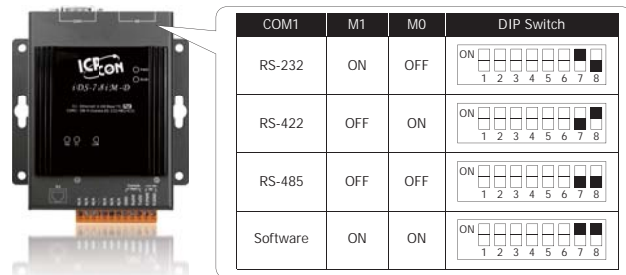

### Easy web-based Configuration

The built-in web server allows the iDS product to be accessed and configured using a standard web browser, such as Internet Explorer or Google Chrome. The configurations include parameters of serial ports, SNMP, the mode of Serial-To-Ethernet service. In addition, the onboard Flash memory provides the capacity for future software upgrades.

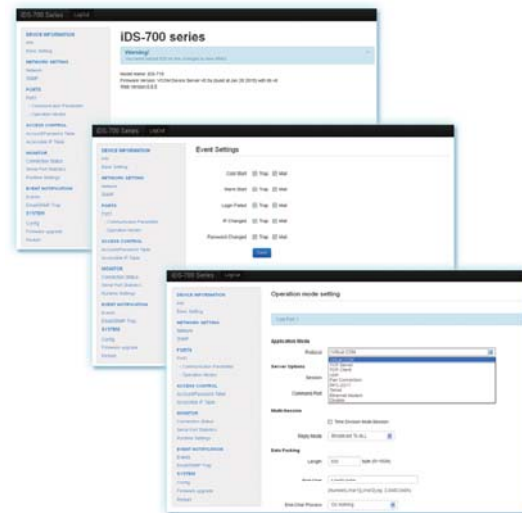

### IT-friendly Management

All devices in the iDS product range support the SNMP protocol, which is a popular method within the IT industry for monitoring a device over the Ethernet. The iDS device can be configured to send SNMP-Trap alerts to the SNMP manager if user-defined errors or events are encountered. For example, alerts can be triggered by a warm/cold start events, or a password change, etc. An email alert and web-based event log page is also provided.

### Perfect Harmony

Making the right decision leads to lazy days on the beach



- Remote Configuration and Upgrades
- Embedded Watchdog prevents System Freeze
- Event and Alarm Logs with Timestamp
- Event alert: SNMP Trap, E-mail

### Ordering Information:

Model No.	Description
iDS-718i-D CR	Intelligent Device Server with 1 RS-232/422/485 (Isolated, RoHS, DB9)
iDS-718iM-D CR	Intelligent Device Server with 1 RS-232/422/485 (Isolated, Metal Case, RoHS, DB9)
iDS-728i-T CR	Intelligent Device Server with 2 RS-232/422/485 (RoHS, Terminal block)
iDS-728iM-T CR	Intelligent Device Server with 2 RS-232/422/485 (Metal Case, RoHS, Terminal block)
iDS-448iM-D CR	Intelligent Device Server with 4 RS-232/422/485 (Metal Case, RoHS, DB9)

## 2.2 Palm-size Programmable Serial-to-Ethernet Device Server

### PDS-720(D)

### PPDS-720(D)-MTCP

Programmable Device Server with 1 RS-232, 1 RS-422/485 and 1 Fiber ports



PPDS-720D-MTCP PDS-720



### PDS-782-25/D6

### PDS-782D-25/D6

Programmable Device Server with 7 RS-232 ports and 1 RS-485 port



### PDS(M)-700(D) Series

### PPDS(M)-700(D)-MTCP Series

Programmable Device Server with 1 RS-232 port and 1 RS-485 port



PPDS-700D-MTCP series PDSM-700D series



### Features:

- Incorporates serial devices in an Ethernet network
- Operation Modes: Virtual COM, TCP Server, TCP Client
- Virtual COM for 32/64-bit Windows XP/2012/7/10
- Supports Modbus TCP to RTU/ASCII Gateway (for MTCP versions)
- Powerful programmable device server with lib and sample programs
- Built-in high performance MiniOS7 from ICP DAS
- Built-in watchdog timer suitable for use in harsh environments
- Built-in Self-Tuner on RS-485 Ports (automatic direction control)
- Supports ±4 kV ESD protection on serial ports
- Power reverse polarity protection and low power consumption
- 10/100 Base-TX Ethernet, RJ-45 Port (Auto-negotiating, auto MDI/MDI-X, LED indicator)
- Supports PoE (Power over Ethernet, for PPDS versions)
- Built-in 7-Segment 5-digit LED display (for D versions)
- Supports D/I, latched D/I and counter functions (for models with DIO)
- Supports Virtual I/O technology (for models with DIO)
- Supports IP filter (White List) for security control
- Supports multi-client and data sharing function
- Palm-size form factor with multiple serial ports and DIN-Rail mounting
- RoHS Compliant & no Halogen
- OEM/ODM service is available



## Selection Guide:

Model Name	RS-232	RS-485	RS-422/ RS-485	DI/DO	Ethernet	COM1	COM2	COM3	COM4	COM5	COM6	COM7	COM8
PDS-720(D) PPDS-720(D)-MTCP	1	1	-	-	10/100 M	5 Wire RS-232	2 Wire RS-485	-	-	-	-	-	-
PDS(M)-721(D) PPDS(M)-721(D)-MTCP	1	1	-	6/7	10/100 M	5 Wire RS-232	2 Wire RS-485	-	-	-	-	-	-
PDS(M)-732(D) PPDS(M)-732(D)-MTCP	2	1	-	4/4	10/100 M	5 Wire RS-232	2 Wire RS-485	5 Wire RS-232	-	-	-	-	-
PDS(M)-734(D) PPDS(M)-734(D)-MTCP	1	1	1	4/4	10/100 M	5 Wire RS-232	2 Wire RS-485	RS-422/ RS-485	-	-	-	-	-
PDS(M)-742(D) PPDS(M)-742(D)-MTCP	3	1	-	-	10/100 M	5 Wire RS-232	2 Wire RS-485	5 Wire RS-232	9 Wire RS-232	-	-	-	-
PDS(M)-743(D) PPDS(M)-743(D)-MTCP	3	1	-	4/4	10/100 M	5 Wire RS-232	2 Wire RS-485	3 Wire RS-232	3 Wire RS-232	-	-	-	-
PDS(M)-752(D) PPDS(M)-752(D)-MTCP	4	1	-	-	10/100 M	5 Wire RS-232	2 Wire RS-485	5 Wire RS-232	5 Wire RS-232	5 Wire RS-232	-	-	-
PDS(M)-755(D) PPDS(M)-755(D)-MTCP	1	4	-	-	10/100 M	5 Wire RS-232	2 Wire RS-485	2 Wire RS-485	2 Wire RS-485	2 Wire RS-485	-	-	-
PDS(M)-762(D) PPDS(M)-762(D)-MTCP	5	1	-	1/2	10/100 M	5 Wire RS-232	2 Wire RS-485	3 Wire RS-232	3 Wire RS-232	3 Wire RS-232	3 Wire RS-232	-	-
PDS(M)-782(D) PPDS(M)-782(D)-MTCP	7	1	-	-	10/100 M	5 Wire RS-232	2 Wire RS-485	3 Wire RS-232	3 Wire RS-232	3 Wire RS-232	3 Wire RS-232	3 Wire RS-232	3 Wire RS-232
PDS-782(D)-25/D6	7	1	-	-	10/100 M	5 Wire RS-232	2 Wire RS-485	3 Wire RS-232	3 Wire RS-232	3 Wire RS-232	3 Wire RS-232	3 Wire RS-232	3 Wire RS-232

**Note:**

1. The D version modules have a built-in 7-Seg. LED Display.
2. The M version modules use metal case.
3. The PPDS-700-MTCP series modules support PoE (Power over Ethernet) and Modbus Gateway.

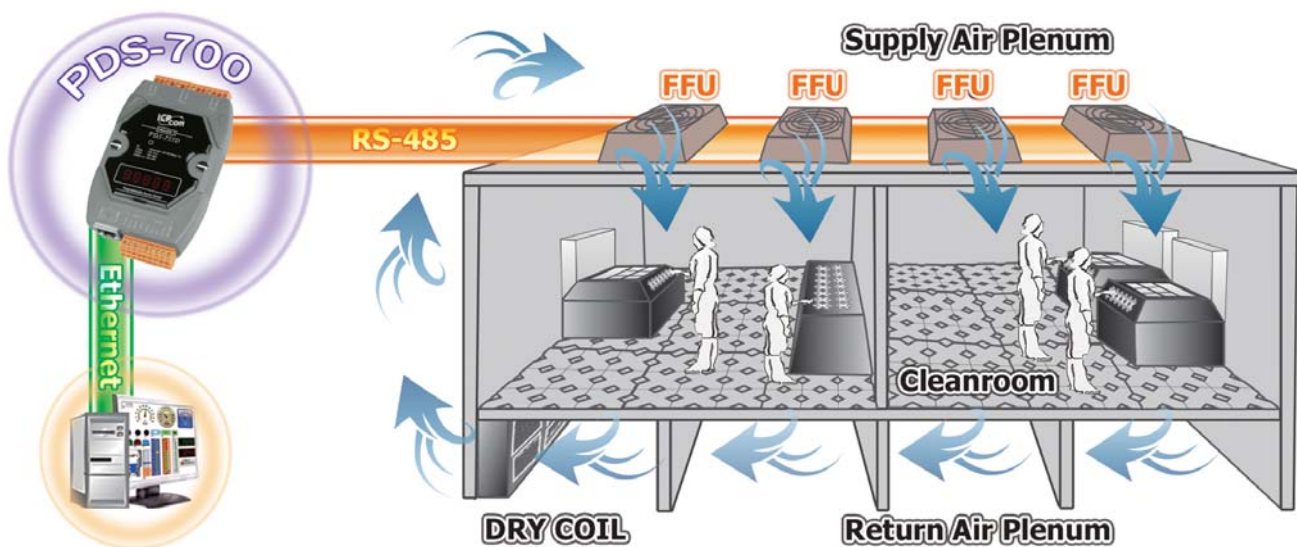

## 2.3 Palm-size Serial-to-Ethernet Device Server

### DS-712

Serial-to-Ethernet Device Server with 1 RS-232 port

### DS-715

Serial-to-Ethernet Device Server with 1 RS-422/RS-485 port



### Features:

- Incorporate Serial Devices in an Ethernet network
- Operation Modes: Virtual COM, TCP Server, TCP Client
- Virtual COM for 32/64-bit Windows XP/2012/7/10
- Watchdog Timer suitable for use in harsh environments
- 10/100 Base-TX, RJ-45 Port  
(Auto-negotiating, auto MDI/MDI-X, LED indicator)
- Built-in High Performance MiniOS7 from ICP DAS
- High Performance Device Server
- Power Reverse Polarity Protection
- RoHS Compliant & no Halogen
- Serial Port  $\pm 4$  kV ESD Protection Circuit
- Low power consumption
- Palm-Size with DIN-Rail Mounting
- Male DB-9 Connector

### Introduction:

The DS-700 is a series of Serial-to-Ethernet Device Servers that are designed for linking RS-232/422/485 devices to an Ethernet network. By using the VxComm Driver/Utility, the built-in COM port of the DS-700 series can be virtualized to a standard PC COM port in Windows. By virtue of its protocol independence, a small size and flexibility, the DS-700 series meets the demands of virtually any network-enabled application.

The DS-712 is equipped with a male DB-9 connector and supports a 5 Wire RS-232 port, while the DS-715 is equipped with a removable terminal block connector and supports a 4 Wire RS-422 port or a 2 Wire RS-485 port with 2000 Vrms isolation.

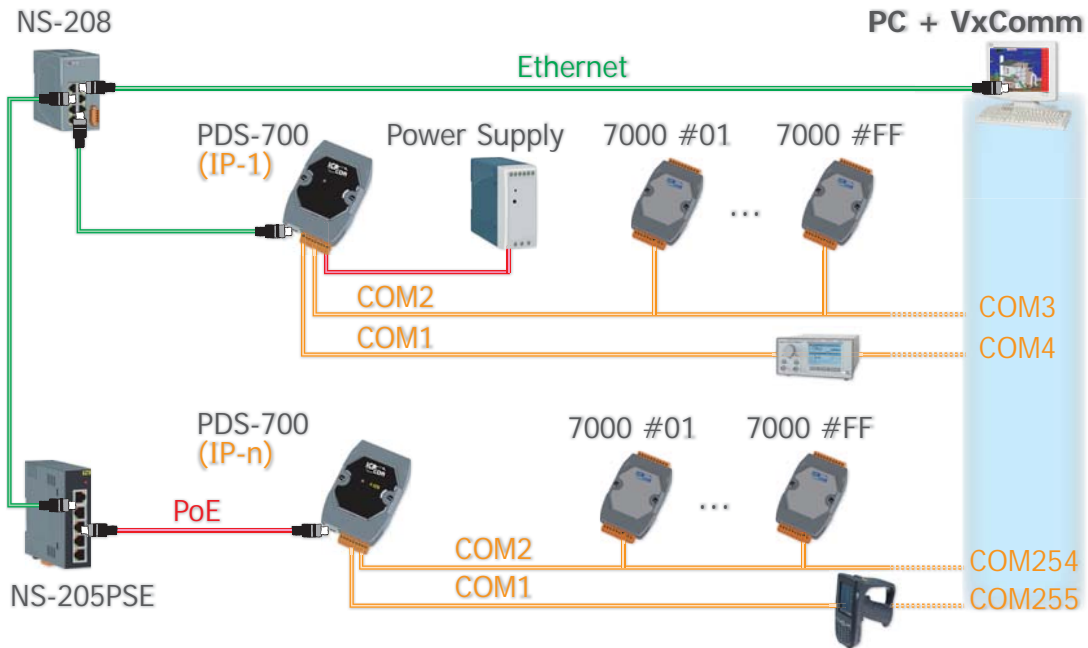

### Ordering Information:

Model No.	Description
DS-712 CR	Device Server with 1 RS-232 port (RoHS)
DS-715 CR	Device Server with 1 Isolated RS-422/RS-485 port (RoHS)

## 2.4 IP67 Programmable Serial-to-Ethernet Device Server

**PPDS-741-IP67** *Available soon*

**PPDS-742-IP67**

**PPDS-743-IP67** *Available soon*

Programmable Device Server with 4 RS-232 or RS-485 ports,  
PoE and IP67 Casing



### Features:

- Incorporate Serial Devices in an Ethernet network
- Virtual COM for 32-bit and 64-bit Windows XP/2012/7/10
- Watchdog Timer suitable for use in harsh environments
- 10/100 Base-TX, RJ-45 Port  
(Auto-negotiating, auto MDI/MDI-X, LED indicator)
- Built-in High Performance MiniOS7 from ICP DAS
- Self-Tuner ASIC Controller on the RS-485 Port
- Powerful Programmable Device Server
- Rugged RJ-45 Connector for anti-vibration and shock
- Plastic Casing with IP67 Waterproof
- Power Reverse Polarity Protection
- RoHS Compliant & no Halogen
- Serial Port  $\pm 4$  kV ESD Protection Circuit
- Low power consumption
- Supports PoE (IEEE 802.3af, Class 1)
- ODM Service is available

### Introduction:

The PPDS-700-IP67 series is a family of Programmable Device Servers, also known as "Serial-to-Ethernet gateway", that are designed for linking RS-232/422/485 devices to an Ethernet network. The user-friendly VxComm Driver/Utility allows users to easily turn the built-in COM ports of the PPDS-700-IP67 series into standard COM ports on a PC. By virtue of its protocol independence, a small-core OS and high flexibility, the PPDS-700-IP67 series is able to meet the demands of every network-enabled application.

The PPDS-700-IP67 series includes a powerful and reliable Xserver programming structure that allows you to design your robust Ethernet applications in one day. The built-in, high-performance MiniOS7 boots the PPDS-700-IP67 up in just one second and gives you fastest responses.

**The PPDS-700-IP67 is a special design for the toughest applications. It can be directly mounted to any machine or convenient flat surface. The rugged packaging and IP67 connectors are rated to protect against water, oil, dust, vibration, and much more.**

The PPDS-700-IP67 supports PoE (Power over Ethernet) function that allows power and data to be carried over a single Ethernet cable, so a device can operate solely from the power it receives through the data cable. This innovation allows greater flexibility in office design, higher efficiency in systems design, and faster turnaround time in set-up and implementation. When there is no PoE switch on site, the PPDS-700-IP67 accepts power input from a +12 VDC  $\sim$  +48 VDC adapter.

When using PoE devices such as the PPDS-700-MTCP, PPDS-700-IP67 and PET-7000 (Ethernet I/O module with PoE), you can select the ICP DAS "PoE" switch – "NS-205PSE" – as the power source. The NS-205PSE automatically detects whether the connected devices are PoE devices or not. This mechanism ensures that the NS-205PSE will work with both PoE and non-PoE devices simultaneously.

As a power source for PoE devices, the NS-205PSE requires a power input ranging from +46 VDC  $\sim$  +55 VDC.

### Ordering Information:

Model No.	Description
<b>PPDS-741-IP67 CR</b>	Programmable Device Server with 1 RS-232 port, 3 RS-485 ports, PoE and IP67 Casing (RoHS)
<b>PPDS-742-IP67 CR</b>	Programmable Device Server with 2 RS-232 ports, 2 RS-485 ports, PoE and IP67 Casing (RoHS)
<b>PPDS-743-IP67 CR</b>	Programmable Device Server with 3 RS-232 ports, 1 RS-485 port, PoE and IP67 Casing (RoHS)



# 2.5 Programmable Serial-to-Fiber Device Server

## PDS-220Fx

Programmable Device Server with 1 RS-232, 1 RS-422/485 and 1 Fiber ports



### Features:

- Adds optical fiber connectivity to serial devices
- Virtual COM for 32-bit and 64-bit Windows XP/2012/7/10
- Watchdog Timer suitable for use in harsh environments
- Serial Port  $\pm 4$  kV ESD Protection Circuit
- RoHS Compliant & no Halogen
- 100 Base-FX (SC/ST connector)
- Low power consumption
- "Virtual COM" extends PC COM ports
- Powerful Programmable Device Server
- Power Reverse Polarity Protection
- Self-tuner ASIC Controller on the RS-485 port
- Built-in high performance MiniOS7 from ICP DAS
- ODM Service is available

### Introduction:

The PDS-220Fx series is a family of Programmable Device Servers, also known as "Serial-to-Fiber gateway", that are designed for adding optical fiber connectivity to RS-232/422/485 devices.

The fiber-optic communications permits transmission over longer distances than other forms of communications because of the signals travel along them with less loss and no crosstalk. It has following important features:

- Immunity to electromagnetic interference (EMI) — Motors, relays, welders and other industrial equipment generate a tremendous amount of electrical noise that can cause major problems with copper cabling.
- High electrical resistance, making it safe to use near high voltage equipment or between areas with different earth potentials.
- No sparks — important in flammable or explosive gas environments.
- Not electromagnetically radiating, and difficult to tap without disrupting the signal — important in high-security environments.

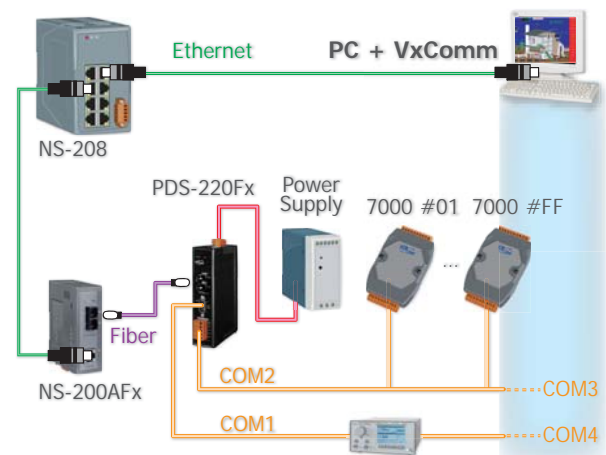

Because of these reasons, optical fibers have largely replaced copper wire communications in core networks in the developed world. The user-friendly VxComm Driver/Utility allows users to easily turn the built-in COM ports of the PDS-220Fx series into standard COM ports on a PC. By virtue of its protocol independence, a small-core OS and high flexibility, the PDS-220Fx series is able to meet the demands of every network-enabled application.

The PDS-220Fx series includes a powerful and reliable Xserver programming structure that allows you to design your robust Ethernet applications in one day. The built-in, high-performance MiniOS7 boots the PDS-220Fx up in just one second and gives you fastest responses.

The PDS-220Fx is equipped with 1 RS-232 port and 1 RS-422/485 port. The removable onboard terminal block connector is designed for easy and robust wiring in industrial situations.

### Ordering Information:

Model No.	Description
PDS-220FT CR	Programmable Device Server with 1 RS-232, 1 RS-422/485 and 1 Multi-mode ST Fiber Port (RoHS)
PDS-220FC CR	Programmable Device Server with 1 RS-232, 1 RS-422/485 and 1 Multi-mode SC Fiber Port (RoHS)
PDS-220FCS CR	Programmable Device Server with 1 RS-232, 1 RS-422/485 and 1 Single-mode SC Fiber Port (RoHS)
PDS-220FCS-60 CR	Programmable Device Server with 1 RS-232, 1 RS-422/485 and 1 Single-mode SC Fiber Port (RoHS)

# 2.6 Tiny Serial-to-Ethernet Device Server & Modbus Gateway

## tDS-700/tDS-2200 Series

Tiny Serial-to-Ethernet Device Server



### Features:

- Incorporates any RS-232/422/485 serial device in Ethernet
- Contains a 32-bit MCU that efficiently handles network traffic
- Operation Modes: Virtual COM, TCP Server, TCP Client
- Virtual COM for 32/64-bit Windows XP/2012/7/10
- Data Packing Modes: Length, Delimiter, timeout, Char-timeout
- Supports pair-connection (serial-bridge, serial-tunnel) applications
- Supports UDP responder for device discovery (UDP Search)
- Tiny Web server for serial and network configuration (HTTP)
- Easy firmware update via the Ethernet (BOOTP, TFTP)
- Static IP or DHCP network configuration
- Allows automatic RS-485 direction control
- tDS-700/tDSM-712: 10/100 Base-TX Ethernet, RJ-45 × 1
- tDS-2200: 2-port Ethernet Switch (LAN Bypass for Daisy-Chain Wiring)
- Includes redundant power inputs: PoE and DC jack
- Male DB-9 or terminal block connector for easy wiring
- Tiny form-factor and low power consumption

### Introduction:

The tDS-700 is a series of Serial-to-Ethernet device servers designed to add Ethernet and Internet connectivity to any RS-232 and RS-422/485 device, and to eliminate the cable length limitation of legacy serial communication. By using the VxComm Driver/Utility, the built-in COM port of the tDS-700 series can be virtualized to a standard PC COM port in Windows. Therefore, users can transparently access or monitor serial devices over the Internet/Ethernet without software modification.

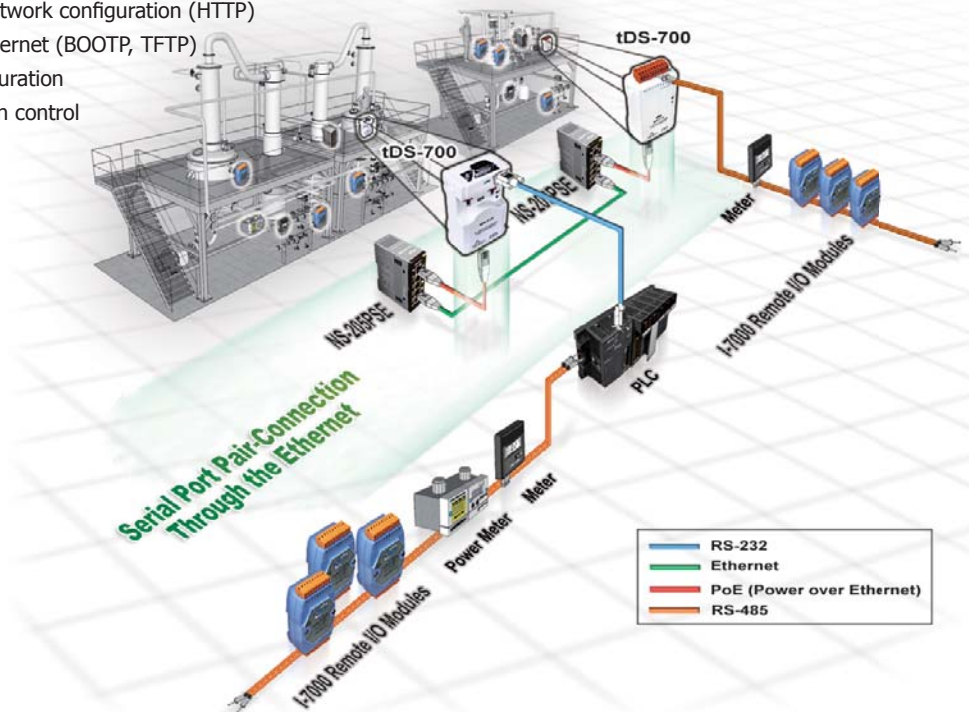

### Ordering Information:

tDS-700/tDS-2200 Series (Tiny Device Server with PoE and DC jack) : Includes one CA-002 cable.							
Model (Non-Isolated)	Model (Isolated)	Case	COM Port	Ethernet	Isolation	ESD Protection	Power Input
tDS-712 CR	▶tDS-712i CR	Plastic	1 × RS-232	1-Port, 10/100 M	3000 VDC for "i" version	±4 kV	+12 ~ 48 VDC (Includes 1 × CA-002 cable) or PoE (IEEE 802.3af, Class 1)
tDSM-712 CR	-	Metal					
tDS-722 CR	▶tDS-722i CR	Plastic	2 × RS-232				
tDS-732 CR	▶tDS-732i CR	Plastic	3 × RS-232				
tDS-715 CR	tDS-715i CR	Plastic	1 × RS-422/RS-485				
tDS-725 CR	tDS-725i CR	Plastic	2 × RS-485				
tDS-735 CR	tDS-735i CR	Plastic	3 × RS-485				
tDS-718 CR	▶tDS-718i CR	Plastic	1 × RS-232 or RS-422/485				
tDS-724 CR	▶tDS-724i CR	Plastic	1 × RS-485 1 × RS-232				
tDS-734 CR	▶tDS-734i CR	Plastic	1 × RS-485 2 × RS-232				
▶tDS-2212 CR	-	Plastic	1 × RS-232	2-Port Switch, 10/100 M	-	±4 kV	+12 ~ 48 VDC or PoE (IEEE 802.3af, Class 1)
▶tDS-2215 CR	-	Plastic	1 × RS-485				
▶tDS-2225 CR	-	Plastic	2 × RS-485				
▶tDS-2235 CR	-	Plastic	3 × RS-485				
▶tDS-2218 CR	-	Plastic	1 × RS-232 or RS-485				

Note: ▶ Available soon

# tGW-700/tGW-2200 Series

Tiny Modbus/TCP to RTU/ASCII Gateway



## Features:

- Supports Modbus TCP/UDP master and slave
- Supports Modbus RTU/ASCII master and slave
- Read-cache ensures faster Modbus TCP/UDP response
- Supports UDP responder for device discovery (UDP Search)
- Tiny Web server for serial and network configuration (HTTP)
- Easy firmware update via the Ethernet (BOOTP, TFTP)

## Introduction:

The tGW-700/tGW-2200 series module is a Modbus gateway that enables a Modbus TCP/UDP host to communicate with serial Modbus RTU/ASCII devices through an Ethernet network, and eliminates the cable length limitation of legacy serial communication devices. The module can be used to create a pair-connection application, and can then route data over TCP/IP between two serial Modbus RTU/ASCII devices, which is useful when connecting mainframe computers, servers or other serial devices that use Modbus RTU/ASCII protocols and do not themselves have Ethernet capability.

The tGW-700 series provide 1-port Ethernet and tiny form-factor, while the tGW-2200 series provide 2-port Ethernet Switch and permits the daisy chain connection. These modules achieve maximum space savings that allows it to be flexibility and easily installed anywhere.

### Modbus TCP/UDP Master to Modbus RTU/ASCII Slave

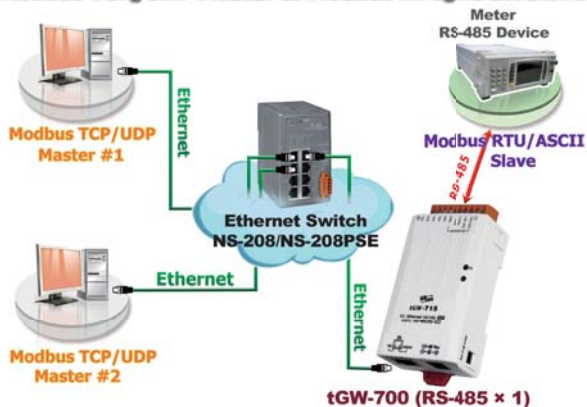

### Daisy-Chain Ethernet Cabling



## Ordering Information:

Model (Non-Isolated)	Model (Isolated)	COM Port	Max. TCP Connections (Masters)	Ethernet	Isolation	ESD Protection	Power Input
tGW-712 CR	▶tGW-712i CR	1 × RS-232	32	1-Port, 10/100 M	3000 VDC for "i" version	±4 kV	+12 ~ 48 VDC (Includes 1 × CA-002 cable) or PoE (IEEE 802.3af, Class 1)
tGW-722 CR	▶tGW-722i CR	2 × RS-232	16				
tGW-732 CR	▶tGW-732i CR	3 × RS-232	10				
tGW-715 CR	tGW-715i CR	1 × RS-422/RS-485	32				
tGW-725 CR	tGW-725i CR	2 × RS-485	16				
tGW-735 CR	tGW-735i CR	3 × RS-485	10				
tGW-718 CR	▶tGW-718i CR	1 × RS-232 or RS-422/485	32				
tGW-724 CR	▶tGW-724i CR	1 × RS-485 1 × RS-232	16				
tGW-734 CR	▶tGW-734i CR	1 × RS-485 2 × RS-232	10				
▶tGW-2212 CR	-	1 × RS-232	32	2-Port Switch, 10/100 M	-	±4 kV	+12 ~ 48 VDC or PoE (IEEE 802.3af, Class 1)
▶tGW-2215 CR	-	1 × RS-485	32				
▶tGW-2225 CR	-	2 × RS-485	16				
▶tGW-2235 CR	-	3 × RS-485	10				
▶tGW-2218 CR	-	1 × RS-232 or RS-485	32				

Note: ▶ Available soon



# tSH-700 Series NEW

## Tiny Serial Port Sharer



tSH-700 series



### Features:

- Supports baud rate conversion application
- Supports two masters sharing one slave port
- Read-cache ensures faster response
- Redundant power inputs: PoE and DC jack
- Tiny form-factor and low power consumption
- Supports Modbus RTU/ASCII protocol conversion
- Raw data mode for most query-response protocols
- Built-in web server for easy configuration (HTTP)
- Allows automatic RS-485 direction control

### Introduction:

The tSH-700 module provides a number of functions, including "Baud Rate Conversion", "Modbus RTU/ASCII Conversion" and "Two Masters Share One Slave". The built-in web server provides easy configuration interface, and no console commands are required.

#### ● Baud Rate Conversion:

This function allows a single master device to communicate with slave devices using different baud rates and data formats. Most query-response protocols (half-duplex), e.g. DCON, are supported in the raw data mode. Full-duplex communication should also work when the data size is smaller than the built-in 512 bytes buffer on each serial port.

#### ● Modbus RTU/ASCII Conversion:

This function allows a single Modbus RTU/ASCII master device to communicate with Modbus RTU/ASCII slave devices using different protocols, baud rates and data formats.

#### ● Two Masters Share One Slave:

This function allows two master devices connected to different serial ports to share slave devices. The queries from the masters are queued in the tSH-700 module and then processed one-by-one. Modbus mode can be used to convert the Modbus RTU/ASCII protocols, while raw data mode can be used for DCON or other query-response protocols. Different baud rates and data formats can also be used on the different serial ports.

#### ● Read-Cache Function:

The built-in read-cache function is used to store previous requests and responses of the Modbus messages in the memory buffer of the tSH-700 module. When other HMI/SCADA master controllers requiring the same information from the same slave RTU device, the cached response is returned immediately. This feature dramatically reduces the loading on the slave serial port communication, ensures faster responses to the master, and improves the stability of the entire system.

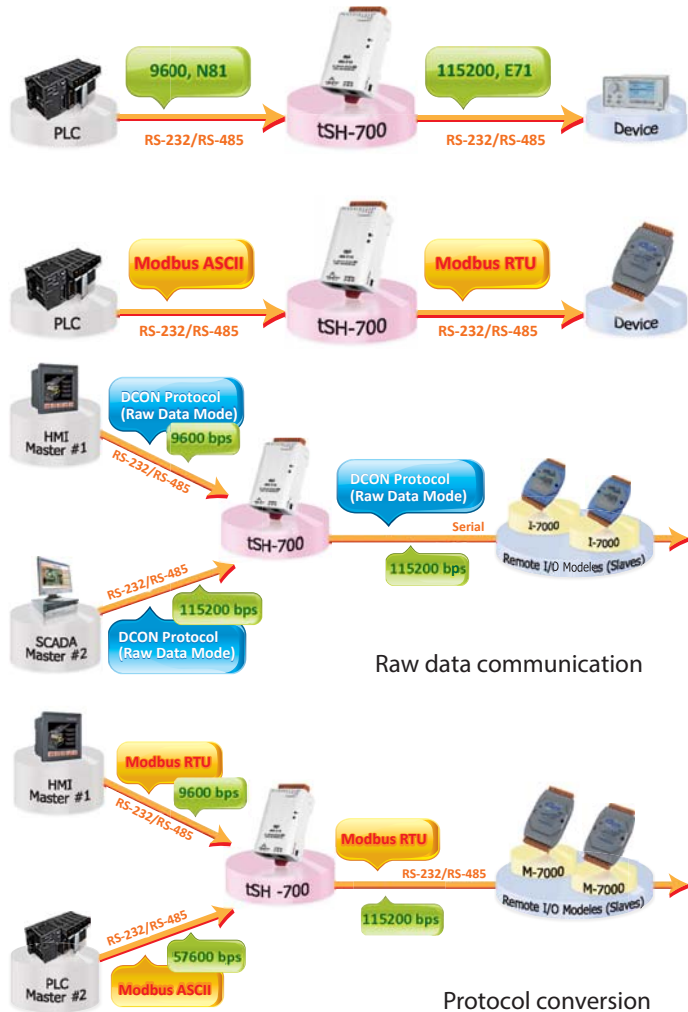

### Ordering Information:

tSH-700 Series (Tiny Serial Port Converter/Sharer with PoE and DC jack) : Includes one CA-002 cable.

Model (Non-Isolated)	Model (Isolated)	RS-232	RS-485	Application	COM1	COM2	COM3
tSH -722 CR	▶ tSH -722i CR	2	-	Converter	3-wire RS-232	3-wire RS-232	-
tSH -725 CR	▶ tSH -725i CR	-	2		2-wire RS-485	2-wire RS-485	-
tSH -724 CR	▶ tSH -724i CR	1	1	Sharer	2-wire RS-485	3-wire RS-232	-
tSH -732 CR	▶ tSH -732i CR	3	-		3-wire RS-232	3-wire RS-232	3-wire RS-232
tSH -735 CR	▶ tSH -735i CR	-	3		2-wire RS-485	2-wire RS-485	2-wire RS-485
tSH -734 CR	▶ tSH -734i CR	2	1		2-wire RS-485	3-wire RS-232	3-wire RS-232

Note: ▶ Available soon

# 2.7 Programmable Serial Device Server with LAN Switch

## PDS-5105D-MTCP

Programmable Device Server with 10 RS-485 Ports, 2-port LAN Switch and LED Display



### Features:

- Integrates any RS-485 serial device in an Ethernet Network
- Virtual COM extends the PC COM ports
- Virtual COM supports 32-bit and 64-bit Windows XP/2012/7/10
- Provides 10 RS-485 ports with Self-Tuner (Auto-direction control)
- ±2 kV ESD protection on serial ports
- RoHS compliant & no halogen
- 2-port 10/100 Base-TX Ethernet Switch with LAN Bypass
- Powerful programmable device server
- Watchdog timer suitable for use in harsh environments
- Power reverse polarity protection
- Built-in high performance MiniOS7 from ICP DAS
- ODM service is available
- Low power consumption

### Introduction:

The PDS-5105D-MTCP is a Programmable Device Server, also known as a "Serial-to-Ethernet gateway" that is designed to allow Ethernet connectivity to be added to RS-232/485 devices.

The user-friendly VxComm Driver/Utility allows users to easily turn the built-in COM ports of the PDS-5105D-MTCP series into standard COM ports on a PC. By virtue of its protocol independence, specialized OS and high flexibility, the PDS-5105D-MTCP series is able to meet the demands of any network-enabled application.

The PDS-5105D-MTCP series includes a powerful and reliable Xserver programming structure that allows you to quickly develop custom robust Ethernet applications. The built-in, high-performance MiniOS7 boots the PDS-5105D-MTCP up in just one second and gives you the fastest response.

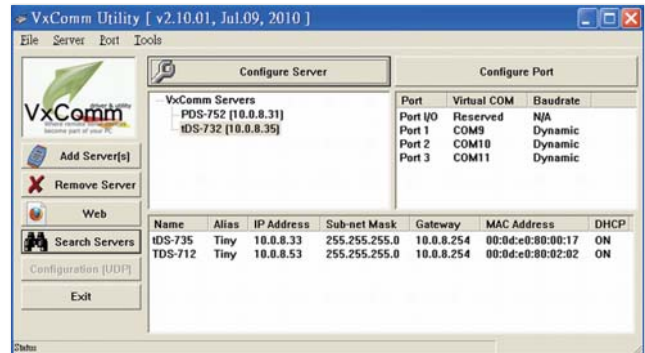

### 2-port Ethernet Switch with LAN Bypass

The PDS-5105D-MTCP is equipped with a 2-port 10/100Base-Tx Ethernet switch that simplifies network wiring by cascading Ethernet devices. Furthermore, the module features a LAN Bypass function allowing network traffic to be continued between two network segments (Ethernet port1 and port2). In cases where the module is offline due to software, hardware or power failure, the LAN Bypass function will be automatically activated, and the essential communications on the network can continue operating without interruption.

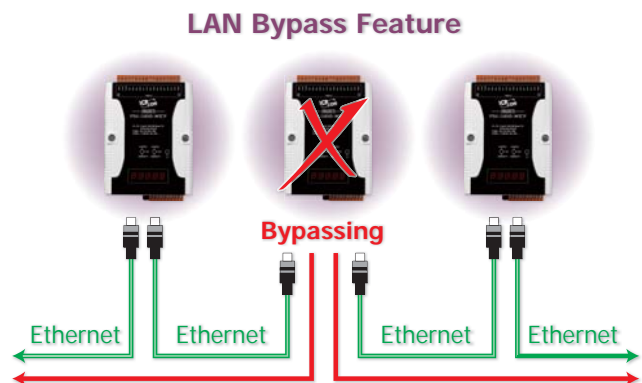

### Ordering Information:

Model No.	Description
PDS-5105D-MTCP CR	Programmable Device Server with 10 RS-485 Ports, 2-port LAN Switch and LED Display. (RoHS)

# 2.8 Programmable Modbus to Ethernet Gateway

## μPAC-7186EX(D)-MTCP

Modbus/RTU to Modbus/TCP Gateway



μPAC-7186EX-MTCP

μPAC-7186EXD-MTCP



### Features:

- Incorporate Serial Devices in an Ethernet network
- Supports Modbus/TCP and Modbus/RTU
- "Virtual COM" extends PC COM ports
- 10/100 Base-TX (Auto-negotiating, auto MDI/MDI-X, LED indicator)
- Self-Tuner ASIC Controller on the RS-485 Port
- 5-digit LED Display (for versions with a display)
- Built-in High Performance MiniOS7 from ICP DAS
- Virtual COM for 32-bit and 64-bit Windows XP/2012/7/10
- Programmable Internet/Ethernet Controller
- Watchdog Timer suitable for use in harsh environments
- Power Reverse Polarity Protection Circuit
- RS-485 Port ESD Protection Circuit
- RoHS Compliant & no Halogen
- Low power consumption

### Introduction:

The Modbus communications protocol has become the de facto industry standard, and is now the most commonly available means of connecting industrial electronic devices.

Modbus allows for communication between many devices connected to the same network, for example a system that measures temperature and humidity and communicates the results to a computer. Modbus is often used to connect a supervisory computer with a remote terminal unit (RTU) in supervisory control and data acquisition (SCADA) systems.

The μPAC-7186EX(D)-MTCP uses a default firmware to become a single Modbus/TCP to multiple Modbus/RTU converter. You can simply use the Modbus Utility to configure the device and then set the connection between the SCADA or HMI software and the μPAC-7186EX(D)-MTCP.

The μPAC-7186EX(D)-MTCP can also link to legacy serial devices that don't support Modbus/RTU. To use this function, you need to install the VxComm driver on the host PCs and create virtual COM ports for the remote serial ports on the μPAC-7186EX(D)-MTCP. You can then directly access the remote serial devices via the virtual COM ports.

Using the Modbus SDK, users can develop their own custom Modbus firmware, allowing extra functions and integration of serial devices. In this way, the μPAC-7186EX(D)-MTCP becomes a powerful controller.

The μPAC-7186EX(D)-MTCP contains a built-in operating system, the MiniOS7, which offers a stable and high performance environment that is similar to DOS. The MiniOS7 can boot up the μPAC-7186EX(D)-MTCP within just one second, with the added benefit of no virus problems and a small footprint. Furthermore, the μPAC-7186EX(D)-MTCP is designed for low power consumption, maintenance elimination (no hard disk and no fan), and is constructed from fire-retardant materials (UL94-V0 level) with a robust case.

### I/O Expansion Bus and Expansion Board

The μPAC-7186EX(D)-MTCP supports a single I/O expansion bus for plugging with a X-board. ICP DAS provides many optional X-boards for the μPAC-7186EX(D)-MTCP, which offers various I/O functions, such as D/I, D/O, A/D, D/A, Timer/Counter, UART, flash memory, battery backup SRAM and AsicKey... etc.

### Ordering Information:

Model No.	Description
μPAC-7186EX-MTCP CR	μPAC-7186EX with Default Modbus/TCP Firmware (RoHS)
μPAC-7186EXD-MTCP CR	μPAC-7186EXD with Default Modbus/TCP Firmware (RoHS)

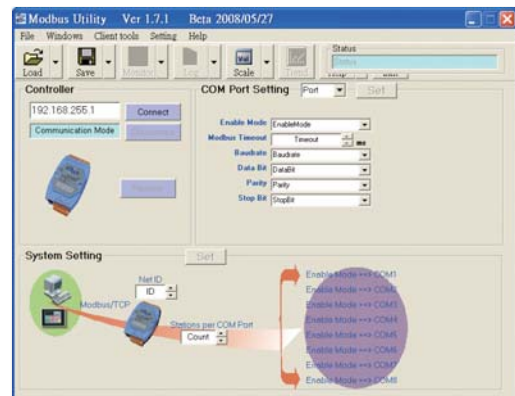



## 2.9 Modbus Data Concentrator, MDC-700 series

### MDC-711

Modbus data concentrator with 1 × Ethernet and 1 × RS-232, 1 × RS-485

### MDC-714

Modbus data concentrator with 1 × Ethernet and 1 × RS-232, 4 × RS-485

### MDC-741

Modbus data concentrator with 1 × Ethernet, 4 × RS-232, 1 × RS-485



### Features:

- Modbus Data Concentrator
- Config.CSV to Ease Hard Work of Editing a lot of Definition
- Great Capability of Shared Memory
- Web Sever to Ease the Operating and Show Clear Information

### Introduction:

MDC-700 series is a Modbus Data Concentrator that has ability to perform up to 200 Modbus/RTU commands to read/write from/to Modbus slave devices via RS-232/485 and allows up to 8 Modbus/TCP masters to get the polled data via the Ethernet.

MDC-700 series provide a built-in web server to ease the configuring and provide clear information for the performed results of each Modbus/RTU command on the RS-232/485.

### Modbus Data Concentrator

The MDC performs the pre-defined Modbus/RTU commands to read/write data from/to the Modbus/RTU slave devices via the RS-232/485. It mirrors the data of the slave devices to its own shared memory. And it accepts up to 8 Modbus/TCP masters to directly read/write data form/to the shared memory instead of polling each Modbus/RTU slave device one by one.

This way not only makes the data on the RS-232/485 sharable to multiple Modbus/TCP master but also shorten the time to read/write data from/to multiple Modbus/RTU slave devices.

### Great Capability of Shared Memory

The MDC can perform up to 200 polling definitions. And the internal shared memory has four tables to store the polled AI, AO, DI and DO data. Each table can store up to 4000 registers.

#	TCPPort	ModbusID							
1	502	1							
#	ModuleInfo								
4	this is my data concentrator								
#	ComPortNo	BaudRate	DataBit	Parity	StopBit	TimeOut	PollDelay	Mode	
6	1	115200	8	0	1	50	20	Master	
7	2	115200	8	0	1	50	20	Master	
8	3	9600	8	0	1	100	20	Master	
9	4	9600	8	0	1	100	20	Master	
10	5	9600	8	0	1	100	20	Master	
#	UseComPort	SlaveModbusID	FunctionCo	RegStartAddr	RegCount				
12	2	1	1	0	4				
13	2	2	2	0	4				
14	2	3	3	0	4				
15	2	4	4	0	4				
16	2	4	4	4	8				

### Config.CSV to Ease Hard Work of Editing a lot of Definition

The Modbus polling definition is defined in a Config.CSV file. Editing/checking a lot of polling definitions is a hard work and may have chance to make a mistake. A CSV format file can ease the work by using Excel. Furthermore, the built-in web server allows users import/export the Config.CSV via a simple mouse-click action.

### Web Sever to Ease the Operating and Show Clear Information

The IP address, configuration file, Config.CSV can be simply configured via the Web server. And the performed results of all Modbus polling definition are shown on the web page. It is very easy to debug which Modbus/RTU device has communication problem. And the MDC firmware will skip the abnormal Modbus polling definition for a while to smoothly perform the whole polling without distribution.

Communication status between host PC and MDC-711: GOOD

**Polling Definition**

- COM1
  - Def. #001 - ID [01], Register [00000:00007] ⇒ Local Register [00000:00007] GOOD
  - Def. #002 - ID [01], Register [10000:10007] ⇒ Local Register [10000:10007] GOOD
- COM2
  - Def. #003 - ID [01], Register [00000:00003] ⇒ Local Register [00008:00011] GOOD
  - Def. #004 - ID [02], Register [10000:10003] ⇒ Local Register [10008:10011] GOOD
  - Def. #005 - ID [03], Register [40000:40003] ⇒ Local Register [40000:40003] GOOD
  - Def. #006 - ID [04], Register [30000:30003] ⇒ Local Register [30000:30003] GOOD

## Applications:

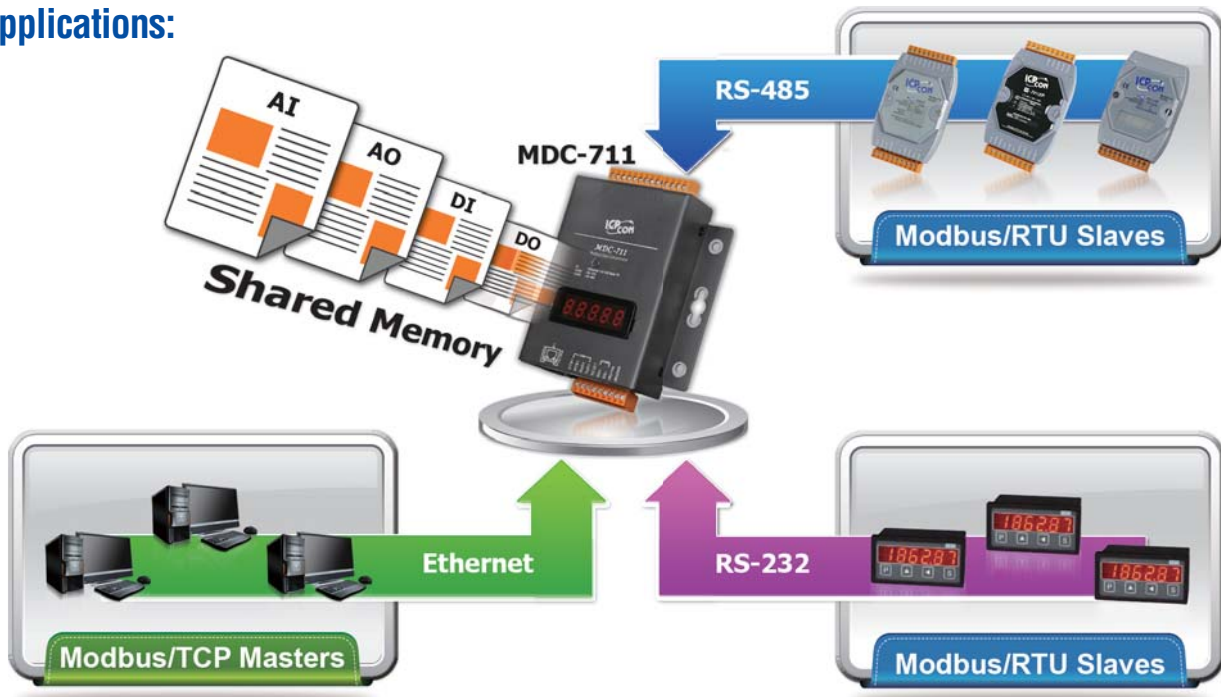

## System Specifications:

Model Name	MDC-711	MDC-714	MDC-741
<b>Ethernet</b>			
Port	x1, 10/100 Base-TX		
Protocol	Modbus/TCP Slave		
Max. connection	8		
<b>COM port</b>			
RS-232	x1, (TXD, RXD, RTS, CTS, GND)		x4, (TXD, RXD, RTS, CTS, GND)
RS-485	x1, (Data+, Data-)	x4, (Data+, Data-)	x1, (Data+, Data-)
Baudrate	1200, 2400, 4800, 9600, 19200, 38400, 57600, 115200		
Data Format	N81, E81, O81		
Protocol	Modbus/RTU Master		
Max. Node	32 nodes for each RS-485 port		
Polling Definition	200 definitions for all RS-232/485 ports		
Shared Memory	4000 registers for each of AI, AO, DI and DO data		
<b>System</b>			
5-Digit 7 Segment LED Display	Yes, to display IP address		
System LED Indicator	Yes, to display hear beat		
<b>Mechanical</b>			
Dimension (W × H × D)	102 mm × 125 mm × 28 mm		
Installation	Wall Mount		
<b>Power</b>			
Required Supply Voltage	+10 VDC ~ +30 VDC (non-regulated)		
Power Consumption	2.5 W		
<b>Environment</b>			
Operating Temperature	-25°C ~ +75°C		
Storage Temperature	-40°C ~ +80°C		
Humidity	5 ~ 95% RH, non-condensing		

## Ordering Information:

Model No.	Description
<b>MDC-711 CR</b>	Modbus data concentrator with 1 × Ethernet and 1 × RS-232, 1 × RS-485 (RoHS)
<b>MDC-714 CR</b>	Modbus data concentrator with 1 × Ethernet and 1 × RS-232, 4 × RS-485 (RoHS)
<b>MDC-741 CR</b>	Modbus Data Concentrator with 1 × Ethernet and 4 × RS-232, 1 × RS-485 (RoHS)

# 3. Converter/Repeater/Hub/Splitter



**ICP DAS Self-Tuner ASIC Features:**

- Multiple Baud Rate
- Multiple Data Format
- Automatic RS-485 Direction Control

Self-Tuner Chip

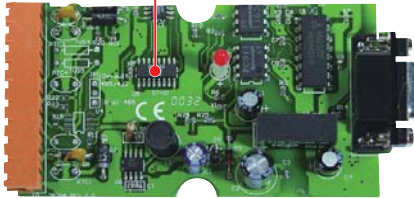

▲ I-7520

**"Self-Tuner"**

A conventional RS-232 to RS-485 converter uses the DIP switch to select the baud rate and data format for the whole RS-485 network. All modules, devices and equipments in the network should be configured to the same baud rate and data format. Unfortunately most real world applications can't be implemented in such a simple way. The Self-Tuner is an innovative chip designed to solve this problem. Every converter contains a Self-Tuner chip. The chip automatically tunes the baud rate and data format to the whole network. Therefore the I-7520 can connect to modules, devices and equipments with different baud rates and data formats in a network.

Furthermore, the RS-485 is a 2 Wire half-duplex network. To transmit and receive data via the twisted pair wire, a transmission direction control for the RS-485 is needed. In conventional designs, software has to switch a hardware handshaking signal such as RTS (Request To Send) to control the transmission direction. The Self-Tuner chip automatically detects and controls the direction of the transmission of the RS-485 network. So the application program does not have to care about the direction control.

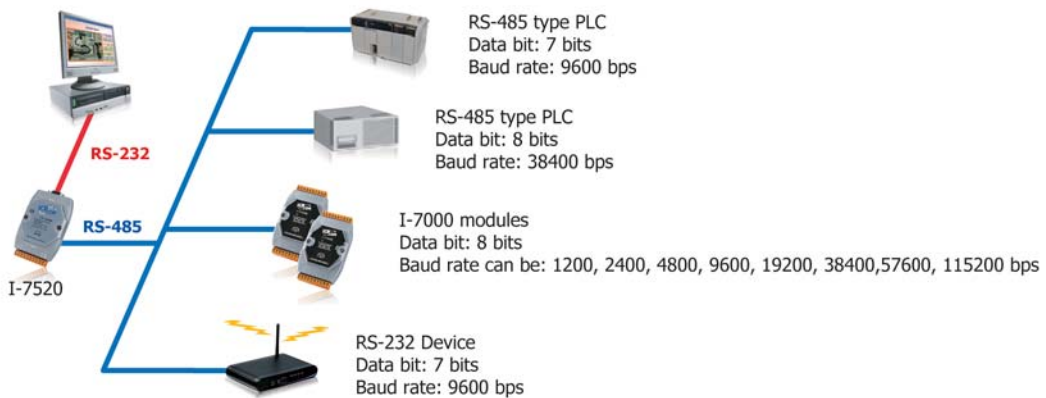

▲ I-7520U4

▲ I-7514U

**High Quality Isolated RS-485 Repeater/Hub/Splitter**

The maximum effective distance of RS-485 without repeater is 1200 meters (4000 feet) at baud rates up to 9.6 Kbps and up to 32 (256) nodes can be connected. With the professional design, the repeater I-7510 solves the problem of signal weakening and extends the maximum effective distance by 1200 m and connects 32 (256) nodes more. And it has optical isolation design for lightning and surge protection. If the RS-485 topology is too complex to make the communicating well, a RS-485 hub or splitter is recommended.

I-7520U4 and I-7514U are multichannel RS-485 repeater/hub/splitter. Each channel is independent and has optical isolation, short circuit and open circuit protection. Thus when one channel fails, it will not affect another channel of the hub. The features make it perfect to star type or mixed type topology in complex and large scale RS-485 network.

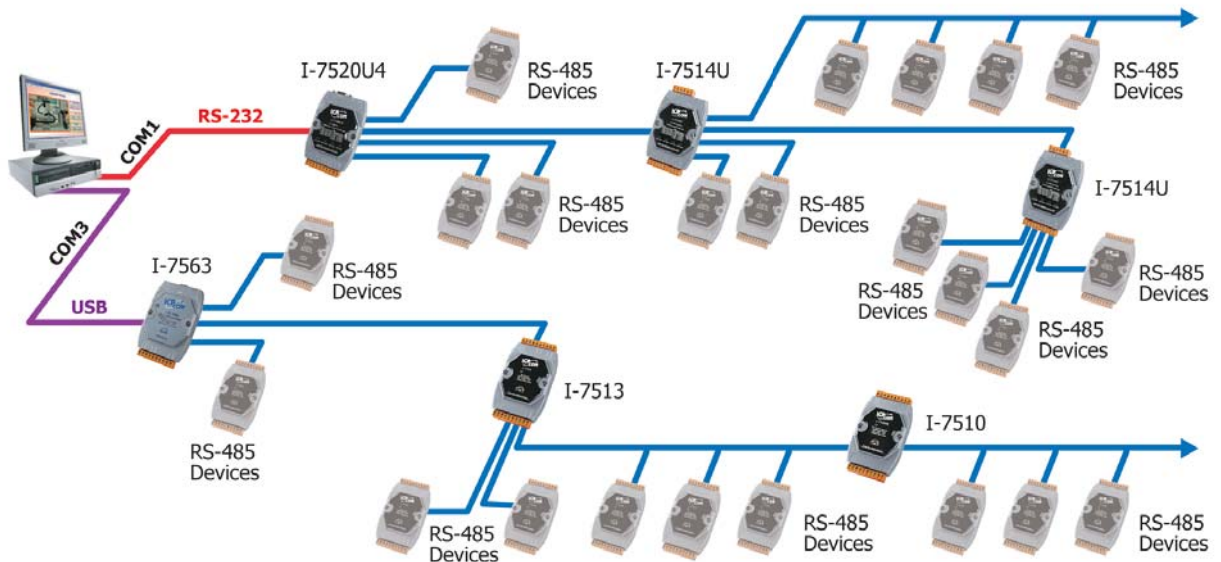



The following block diagram shows how I-7514U was designed as independent channel. Data coming from the master input will be transmitted to all four RS-485 slave channels. But data coming from the slave channels will be returned to the master input only. Thus reduces the possibility of interference between each RS-485 slave loop and makes the RS-485 networks more robust and reliable.

► I-7514U Block Diagram

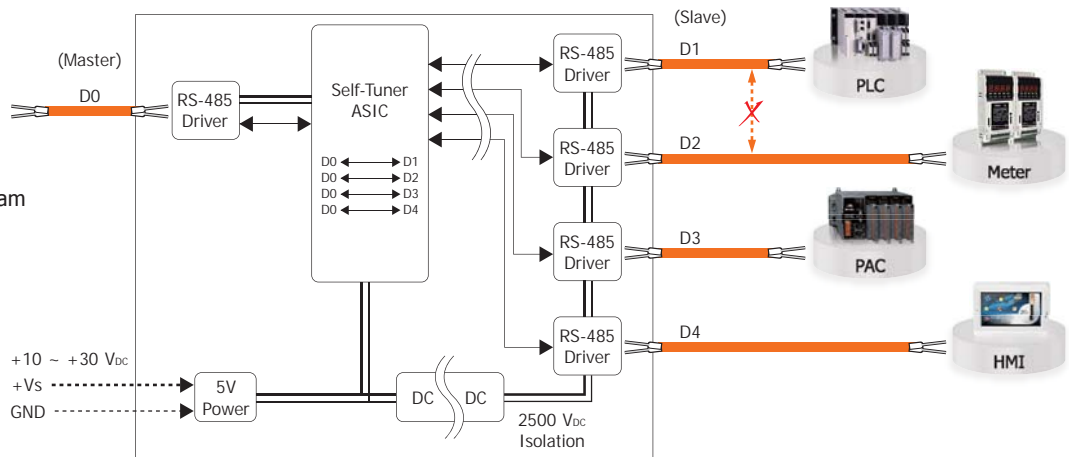

RS-232/422/485 Converter/Repeater

Model Name	tM-7520U	I-7520	I-7520R	I-7520A	I-7520AR	I-7551	tM-7510U	I-7510	I-7510A	I-7510AR
Pictures										
Function	Converter						Repeater			
Interface	RS-232 to RS-485			RS-232 to RS-422/485		RS-232 to RS-232	RS-485	RS-485	RS-422/485	
Isolation	3000 VDC RS-232 side	3000 VDC RS-232 side	3000 VDC RS-485 side	3000 VDC RS-232 side	3000 VDC RS422/485 side	3000 VDC 3 ways	3000 VDC	3000 VDC		3000 VDC 3 ways
Operating Temperature	-25 ~ +75°C									

USB to RS-232/422/485 Converter

Model Name	I-7560U	USB-2514	I-7561U	tM-7561
Pictures				
Function	Converter	Converter	Converter	Converter
Interface	USB to RS-232	USB to 4-Port RS-232	USB to RS-232/422/485	USB to RS-485
Isolation	-	-	3000 VDC	3000 VDC
Operating Temperature	-25 ~ +75°C			

USB RS-232/485 to RS-485 Hub

Model Name	I-7563U	I-7513	I-7520U4	I-7514U
Pictures				
Function	3-Ch Hub/Splitter	3-Ch Hub/Splitter/Repeater	4-Ch Hub/Splitter	4-Ch Hub/Splitter/Repeater
Interface	USB to 3-Ch RS-485	RS-485 to 3-Ch RS-485	RS-232 to 4-Ch RS-485	RS-485 to 4-Ch RS-485
Isolation	3000 VDC	3000 VDC 3 ways	3000 VDC RS-232 side	3000 VDC Ch1-Ch4 side
Operating Temperature	-25 ~ +75°C			

# 4. Termination Resistor/DC Bias Voltage

## tM-SG4

The RS-485 Bias and Termination Resistors Module



### Features:

- Switch-selectable Bias Resistors
- 15-step Switch-selectable Termination Resistor
- LED Indicator for Power/Termination
- DIN-Rail Mountable
- Cost-effective
- Wide Operating Temperature Range: -25 ~ +75°C

### Introduction:

The tM-SG4 is an optional module that is used to improve the communication of RS-485 network. It provides switch selectable bias resistors on RS-485 network. It also has 15-step switch selectable termination resistor such that the user can select a proper termination resistor to be connected to the RS-485 network easily. If the RS-485 network is not over 100 meters, the termination resistors are not needed. Otherwise, it may be necessary to insert two termination resistors at both end of the RS-485 network. It is not easy to calculate the value of a termination resistor on the RS-485 network. The best way to do this is to use an oscilloscope to check the RS-485 signal directly. If the impedance match of RS-485 network is OK, the oscilloscope will show a very nice square wave. If these square wave signals are distorted, the user will need to insert two termination resistors at both end of the RS-485 network.

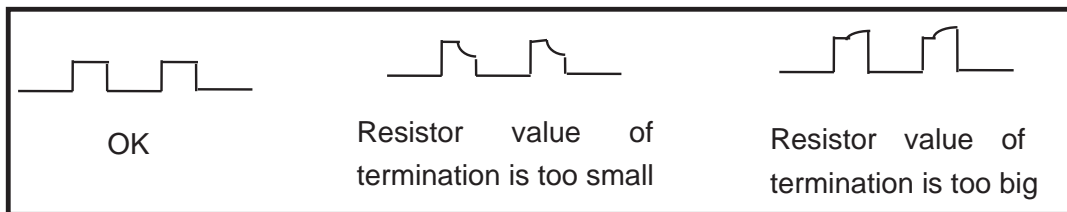

### Applications:

#### Termination Resistor

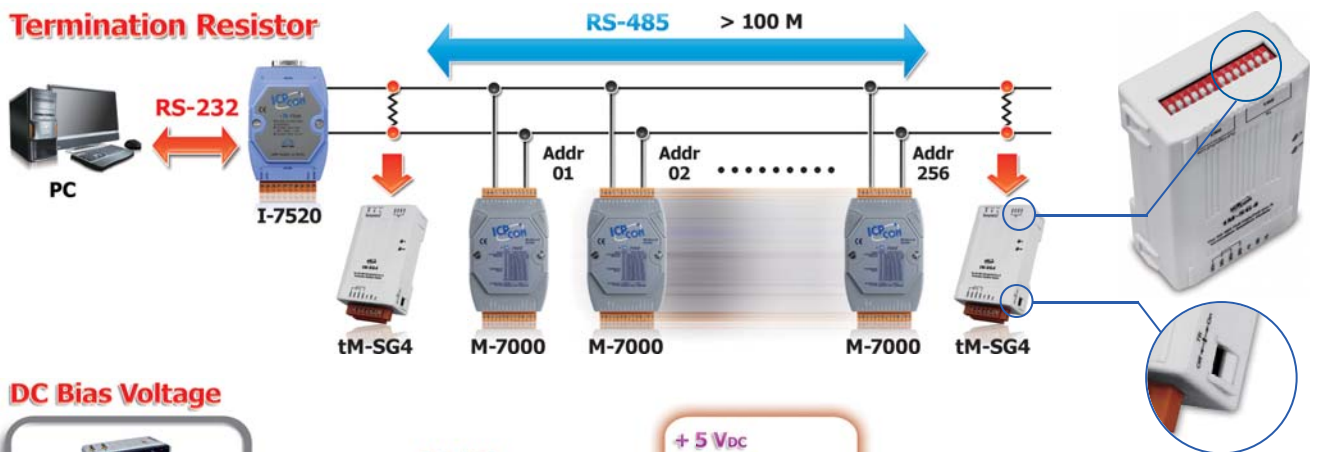

#### DC Bias Voltage



# 5. Ethernet Switch

## Unmanaged Ethernet Switch

Model Name	Speed	Port	Power Input	Housing
NS-105A	10/100 M	5	+12 ~ 53 VDC	Plastic
NS-205-IP67	10/100 M		+10 ~ 30 VDC, isolated	Plastic with IP67
NS-205AG	10/100/1000 M		+12 ~ 48 VDC	Plastic
NS-208AG/NSM-208AG	10/100M/1000 M	8	+12 ~ 48 VDC	Plastic/Metal
NS-208A/NSM-208A	10/100 M		+12 ~ 48 VDC	Plastic/Metal
NS-208-IP67			+12 ~ 53 VDC	Plastic with IP67
NSM-208-M12			+12 ~ 53 VDC	Metal with M12 connector
NSM-208-M12-IP67	+12 ~ 53 VDC		Plastic with M12 connector and IP67	
NSM-216	10/100 M	16	+12 ~ 48 VDC	Metal
NSM-316G	10/100/1000 M		+12 ~ 48 VDC	Metal

## Unmanaged PoE Ethernet Switch

Model Name	Speed	Port	PoE Type (IEEE 802.3at)	Power Input	Housing
NS-105PSE	10/100 M	5	PSE x4	+46 ~ 55 VDC	Plastic
NS-205PSE-IP67	10/100 M			+46 ~ 53 VDC	Plastic with IP67
NSM-205GP	10/100/1000 M			+18 ~ 55 VDC	Metal
NS-208PSE/NSM-208PSE	10/100 M	8	PSE x8	+46 ~ 55 VDC	Plastic/Metal
NSM-208PSE-24V				+18 ~ 55 VDC	Metal
NSM-208PSE-M12				+46 ~ 53 VDC	Metal
NS-208PSE-M12-IP67				+46 ~ 53 VDC	Plastic with M12 connector and IP67
NS-208PSE-IP67				+46 ~ 53 VDC	Plastic with IP67

### Appearance:

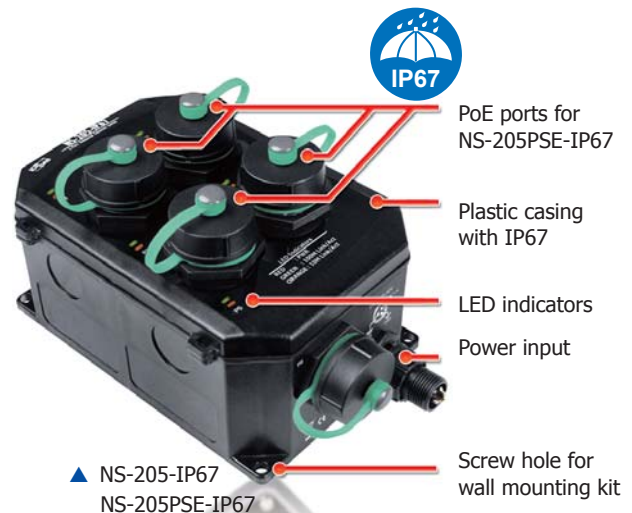
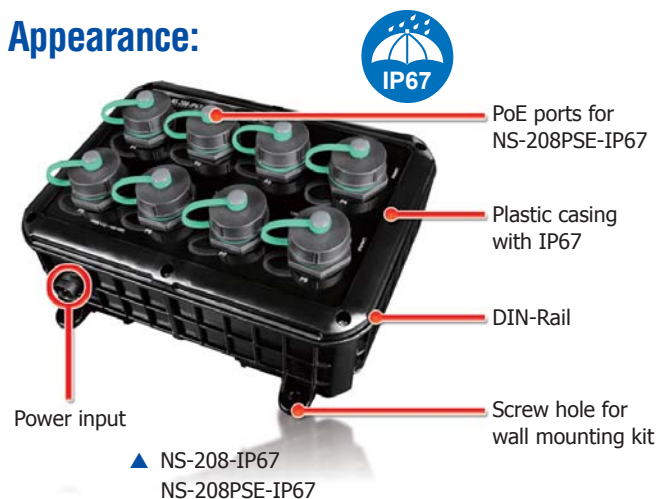



Real-time Redundant Ring Switch

Network topology refers to the way in which the network of switches and other network nodes is connected. In a Cyber-Ring network, every switch or network node has two adjacent neighbors for communication purposes. Cyber-Ring supports a variety of ring network topologies including Single Ring, Ring Coupling and Double Ring Coupling with fault-tolerant capability. The following sections describe in more detail the benefit of those topologies.

**Features:**

- 20 ms (typical) to detect and recover from a Ethernet link failure
- Automatic MDI / MDI-X crossover for plug-and-play
- Full duplex IEEE 802.3x and half duplex backpressure flow control
- Redundant Power Inputs with power failure alarm by relay out
- Store-and-forward architecture
- 3.2 Gbps high performance memory bandwidth
- 1 Mbit Frame buffer memory
- 1024/2048 MAC addresses

**Dual Ring**

The Dual Ring topology can connect separate Cyber-Ring network together (refer to figure 2). It is ideal for two-floor application scene. The Dual Ring topology not only construct individual Cyber-Ring network for each floor but also provide backup path to each other. It is a cost-effective solution to coupling ring topology.

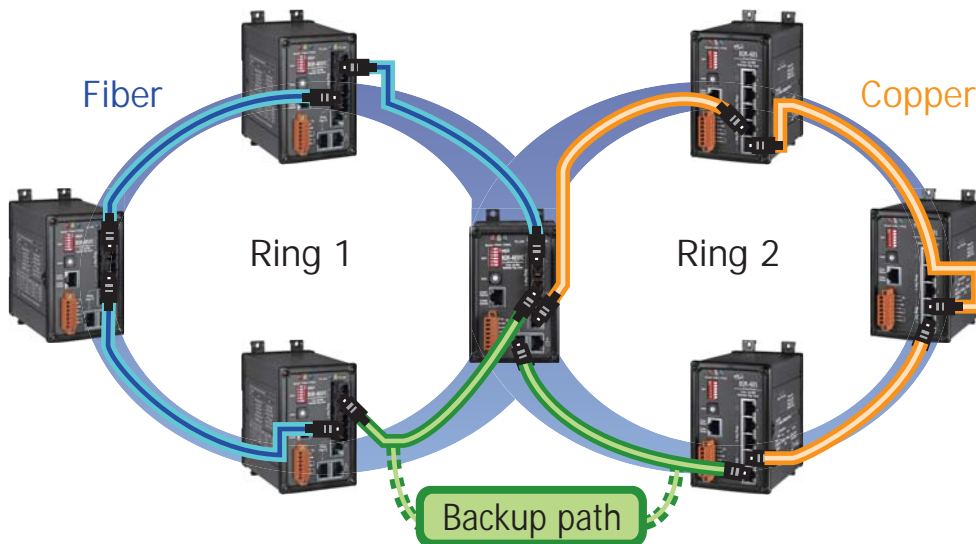

**Solo Ring**

A solo Ring network topology based on Cyber-Ring technology is a cost-effective solution to meet the requirements for link-loss backup in redundant network applications (refer to figure 4). Compared with other ring topology, Solo Ring is composed of ONE ring switch and unmanaged switches (NS series), there is some limit of this topology - longer recovery time and the ring switch is used to close ring topology only. The Solo Ring is most cost-effective redundant topology of Cyber-Ring technology.

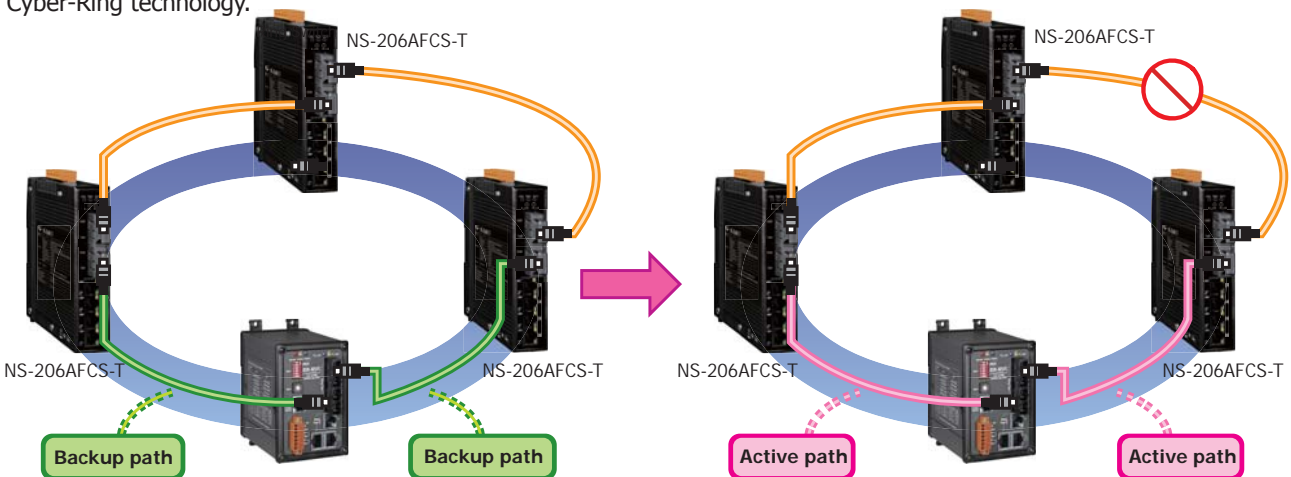

## Single Ring

A Single Ring network topology based on Cyber-Ring technology is an effective solution to meeting the requirements for link-loss backup in industrial field applications. In normal operations, traffic on the backup path is either blocked or ignored, so that if there is a failure in any of the network nodes or within a cable segment on the active path, Cyber-Ring will automatically redirect the disrupted traffic to the backup path. After the affected path is repaired, the network will again be reconfigured to normal operational status.



### Real-time Redundant Ring Ethernet/Fiber Port Switch

Model Name	Ethernet		Fiber Port		Power Input	Housing
	Speed	Port	Speed	Port		
RS-405/RSM-405	10/100 Mbps	5	–	–	+10 ~ 30 VDC	Plastic/Metal
RS-408/RSM-408	10/100 Mbps	8	–	–	+10 ~ 30 VDC	Plastic/Metal
RS-405F/RSM-405F Series	10/100 Mbps	3	100 Mbps	2	+10 ~ 30 VDC	Plastic/Metal
RSM-405-R	10/100 Mbps	5	–	–	+12 ~ 48 VDC	Metal

Managed Ethernet/Fiber Switch

Model Name	Ethernet		Fiber Port				Power Input	Housing
	Speed	Port	Mode	Connector	Speed	Port		
<b>MSM-508</b>	10/100 Mbps	8	–	–	–	–	+12 ~ 48 VDC	Metal
<b>MSM-508F Series</b>	10/100 Mbps	6	–	–	100 Mbps	2	+12 ~ 48 VDC	Metal
<b>FSM-510G-2F</b>	10/100/1000 Mbps	8	SFP cage	LC	100/1000 Mbps	2	+12 ~ 48 VDC	Metal
<b>FSM-510G-4F</b>	10/100/1000 Mbps	6	SFP cage	LC	100/1000 Mbps	4	+12 ~ 48 VDC	Metal
<b>FSM-6228G-DC</b>	10/100/1000 Mbps	24	SFP cage	LC	100/1000 Mbps	4	+12 ~ 48 VDC	Metal
<b>FSM-6228G-AC</b>	10/100/1000 Mbps	24	SFP cage	LC	100/1000 Mbps	4	100 ~ 240 VAC	Metal

### 8-port Industrial Ethernet Layer 2 Managed Switch

#### MSM-508



The MSM-508 is an 8-port Industrial Ethernet (10/100 Base-TX) Layer 2 Managed Switch. MSM-508 supports 10/100M auto negotiation feature and auto MDI/MDI-X function.

- 3.2 Gbps high performance memory bandwidth
- Redundant Power Inputs +12 VDC ~ +48 VDC
- Each port supports both 10/100 Mbps speed auto negotiation
- Full duplex IEEE 802.3x and half duplex backpressure flow control
- Operating temperature range: -40°C ~ +75°C
- Store-and-forward architecture
- Frame buffer memory: 1 Mbit
- Supports 2K MAC Addresses
- Power failure alarm by relay output

### 8-port Industrial Ethernet Layer 2 Managed Switch with 2-Fiber Port

#### MSM-508F Series



The MSM-508F series is an 8-port Industrial Ethernet Layer 2 Managed Switch with 2-Fiber Port that secures data transmission by using fiber optic transmission to provide immunity from EMI/RFI interference.

- 3.2 Gbps high performance memory bandwidth
- Redundant Power Inputs +12 VDC ~ +48 VDC
- Each port supports both 10/100 Mbps speed auto negotiation
- Full duplex IEEE 802.3x and half duplex backpressure flow control
- Operating temperature range: -30°C ~ +75°C
- Store-and-forward architecture
- Frame buffer memory: 1 Mbit
- Supports 2K MAC Addresses
- Power failure alarm by relay output

NEW

### 6-Port 10/100/1000 Base-T + 4 SFP Port L2 Managed Switch 8-Port 10/100/1000 Base-T + 2 SFP Port L2 Managed Switch

#### FSM-510G Series



FSM-510G-4F is a L2 Managed Switch that meets all IEEE 802.3ab/u/x/z Gigabit, Gigabit Ethernet and Ethernet specifications. It provides 6 gigabit Ethernet ports (10/100/1000 Mbps TP) 4 SFP ports.

The switch can be managed through RS-232 serial port via direct connection, or through Ethernet port using Telnet or Web-Based management unit, associated with SNMP agent. With the SNMP agent, the network administrator can logon the switch to monitor, configure and control each port activity in a friendly way. The overall network management is enhanced and the network efficiency is also improved to accommodate high bandwidth applications. In addition, the switch features comprehensive and useful function such as DHCP Option 82, QoS (Quality of Service), Spanning Tree, VLAN, Port Trunking, Bandwidth Control, Port Security, SNMP/RMON

- Network redundant Ring fail-over protection (< 20 ms)
- Multicasting support IGMP v1/v2, proxy & snooping
- L2+ features provide better manageability, security, QoS, and performance
- IEEE 802.3ab 1000BASE-T Gigabit Ethernet
- Multicast/Broadcast/Flooding Storm Control



NEW

## 24-port Ethernet + 4 SFP Layer 2 Gigabit Managed Switch

### FSM-6228G-AC FSM-6228G-DC

FSM-6228G is a L2 Managed Switch that meets all IEEE 802.3ab/u/x/z Gigabit, Gigabit Ethernet and Ethernet specifications. It provides 24 gigabit Ethernet ports (10/100/1000 Mbps TP) 4 SFP ports.



The switch can be managed through RS-232 serial port via direct connection, or through Ethernet port using Telnet or Web-Based management unit, associated with SNMP agent. With the SNMP agent, the network administrator can logon the switch to monitor, configure and control each port activity in a friendly way. The overall network management is enhanced and the network efficiency is also improved to accommodate high bandwidth applications. In addition, the switch features comprehensive and useful function such as QoS (Quality of Service), Spanning Tree, VLAN, Port Trunking, Bandwidth Control, Port Security, SNMP/RMON.

- Network redundant Ring fail-over protection (< 20 ms)
- Multicasting support IGMP v1/v2/v3, proxy & snooping
- L2+ features provide better manageability, security, QoS, and performance
- IEEE 802.3ab 1000BASE-T Gigabit Ethernet
- Multicast/Broadcast/Flooding Storm Control

### Accessories



<b>SFP-1G85M-SX</b>	Multi-mode 850 nm, 0.5 km SFP module
<b>SFP-1G13M-SX2</b>	Multi-mode 1310 nm, 2 km SFP module
<b>SFP-1G13S-LX</b>	Single-mode 1310 nm, 10 km SFP module
<b>SFP-1G13S-LX20</b>	Single-mode 1310 nm, 20 km SFP module
<b>SFP-1G13S-LHX</b>	Single-mode 1310 nm, 40 km SFP module
<b>SFP-1G15S-XD</b>	Single-mode 1550 nm, 60 km SFP module



### PoE Splitter/Injector

A PoE splitter makes the exact invert operation: by the means of a PoE splitter, the power and the data received on the Ethernet cable are split. The power can then be used to power any other electrical device present in the application.

A PoE injector enables the powering of a PoE compatible device over Ethernet in spite of a non PoE capable Ethernet Switch. The PoE injector, placed between the Ethernet switch and the PoE powered device, merges both data (Ethernet Port) and voltage (power connector) on the Ethernet cable.

Model Name	Speed	Input	Output	Housing
<b>NS-200PS</b>	10/100/1000 Mbps	PoE	Ethernet + 24 VDC	Plastic
<b>tNS-200IN</b>	10/100 Mbps	Ethernet + 48 VDC	PoE	Plastic
<b>tNS-200IN-24V</b>	10/100 Mbps	Ethernet + 24 VDC	PoE	Plastic

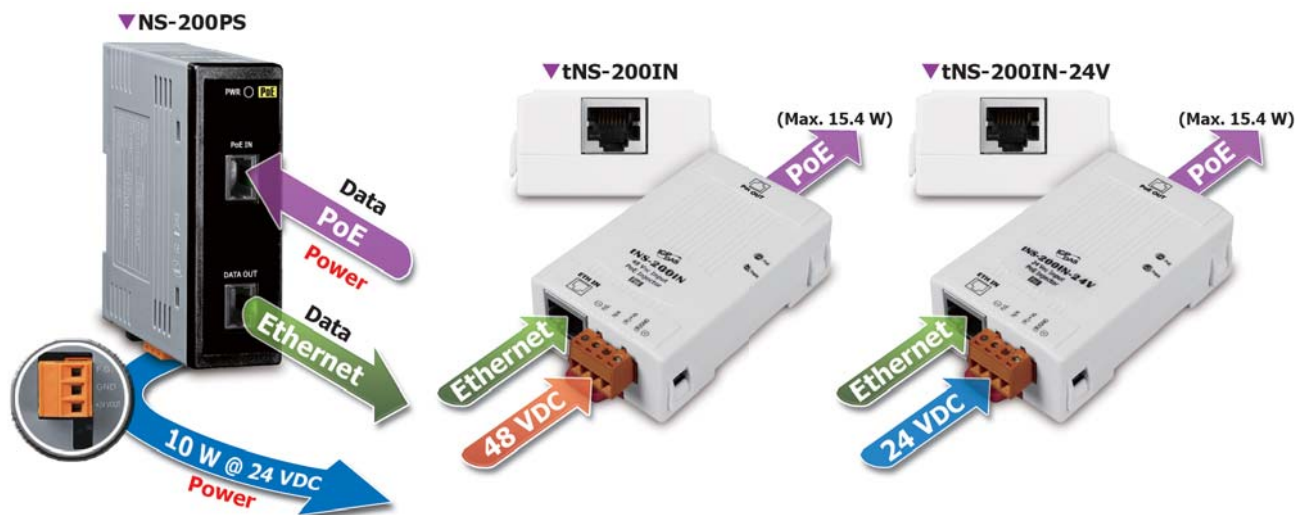

### Industrial Media Converters & WDM Media Converter

A Media Converter is a simple and low-cost networking device which allows connect two dissimilar media types such as an Ethernet cable with fiber optic, even though transmission speed are different. It is a perfect add-on to an Ethernet switch when combining copper and fiber within the Ethernet Network. Multiple cabling types such as coax, twisted pair, multi-mode and single-mode fiber optics are supported.



Model Name	Fiber Port		Ethernet		Operation temperature	Power Input	Housing
	Speed	Port	Speed	Port			
<b>NS-200F series</b>	100 M	1	10/100 M	1	0 ~ +70°C	+10 ~ 30 VDC	Plastic
<b>NS-200WDM</b>	100 M	1	10/100 M	1	0 ~ +70°C	+12 ~ 48 VDC	Plastic
<b>NS-200AF series</b>	100 M	1	10/100 M	1	-30 ~ +75°C	+12 ~ 48 VDC	Plastic
<b>NSM-200G-SFP</b> <b>NSM-200SX/SX2/LX</b>	1000 M	1	10/100/1000 M	1	-30 ~ +75°C	+12 ~ 48 VDC	Metal

### Unmanaged Ethernet Switch with Fiber Ports

An unmanaged industrial Ethernet switch with fiber port(s) provides both Ethernet switch functionality (up to 8 RJ45 ports) and media converter (up to 2 fiber ports) for safe and fast local and long distance (max 60 km) transmissions. Each switch is plug and play, can be installed on DIN-Rail, and supports wide operating temperature range.



Model Name	Fiber		Ethernet			Power Input	Housing
	Speed	Port	Speed	Port	PSE (IEEE 802.3af)		
<b>NS-205AF Series</b> <b>NSM-205AF Series</b>	100 M	1	10/100 M	4	-	+12 ~ 48 VDC	Plastic/Metal
<b>NS-205PF Series</b> <b>NSM-205PF Series</b>	100 M	1	10/100 M	4	4	+12 ~ 48 VDC	Plastic/Metal
<b>NS-206AF Series</b> <b>NSM-206AF Series</b>	100 M	1	10/100 M	4	-	+12 ~ 48 VDC	Plastic/Metal
<b>NS-209F Series</b> <b>NSM-209F Series</b>	100 M	1	10/100 M	8	-	+12 ~ 48 VDC	Plastic/Metal
<b>NSM-210C</b>	1000 M RJ-45/SFP combo ports	2	100/100 M	8	-	+12 ~ 48 VDC	Metal

# 6. Fieldbus Solution

## 6.1 EtherNet/IP Gateways

Model Name	Description	
EtherNet/IP Gateways	GW-7472	Ethernet/IP Adapter to Modbus TCP/RTU Master Gateway
	GW-7473	Modbus TCP/RTU Slave to EtherNet/IP Scanner Gateway

NEW

### EtherNet/IP Adapter to Modbus TCP/RTU Master Gateway

#### GW-7472



The GW-7472 (EtherNet/IP adapter to Modbus TCP/RTU Master Gateway) is helpful for data-exchanging between the Modbus RTU Network, Modbus TCP Network, and the EtherNet/IP Network. It reads the register data from the Modbus RTU slaves as well as Modbus TCP servers and publishes these data to the input register data of the EtherNet/IP scanner. The output data transmitted by the EtherNet/IP scanner are updated to the register data of Modbus TCP/RTU slaves via the GW-7472.

#### Modbus Features >>>

- Maximum support 8 Modbus commands for each one Modbus TCP server
- Modbus Input/Output command data size: maximum 500 bytes
- Supported Modbus Function Code 01, 02, 03, 04, 05, 06, 15, and 16
- Modbus Protocol: Modbus TCP/RTU master protocols
- Maximum support 30 Modbus RTU commands
- Maximum support 10 Modbus TCP servers

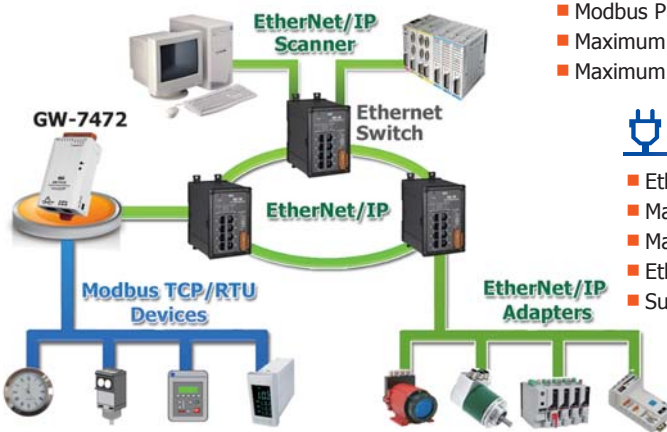

#### EtherNet/IP Features >>>

- Ethernet Protocol: EtherNet/IP adapter
- Maximum number of connections for Explicit Messages: 6
- Maximum number of connections for Implicit Messages: 1
- EtherNet/IP Input/Output command data size: maximum 500 bytes
- Supported I/O connection methods:
  - ★ Transport and trigger: Exclusive-Owner, Cyclic
  - ★ Originator to Target Type: POINT2POINT
  - ★ Target to Originator Type: POINT2POINT, MULTICAST

NEW

### Modbus TCP/RTU Slave to EtherNet/IP Scanner Gateway

#### GW-7473



The GW-7473 (Modbus TCP/RTU Slave to EtherNet/IP Scanner Gateway) is helpful for data-exchanging between Modbus Master and EtherNet/IP adapter. It reads the register data from the EtherNet/IP adapter and publishes these data to the input register data of the Modbus TCP client as well as Modbus RTU Master. The output data transmitted by the Modbus TCP/RTU Master are updated to the register data of EtherNet/IP adapter.

#### Modbus Features >>>

- Modbus Protocol: Modbus TCP Server/RTU Slave protocols
- Supported Modbus Function Code 01, 02, 03, 04, 05, 06, 15, and 16
- Maximum support 5 Modbus TCP clients

#### EtherNet/IP Features >>>

- Supported Objects according to CIP Standard
  - ★ Assembly Object
  - ★ Connection Manager Object
  - ★ Ethernet Link Object
  - ★ Message Router Object
  - ★ TCP/IP Interface Object
- Ethernet Protocol: EtherNet/IP Scanner
  - ★ Class 1 (connected) I/O Server and Client
  - ★ Maximum support 5 EtherNet/IP adapter connections
  - ★ EtherNet/IP I/O command data size: 200 bytes

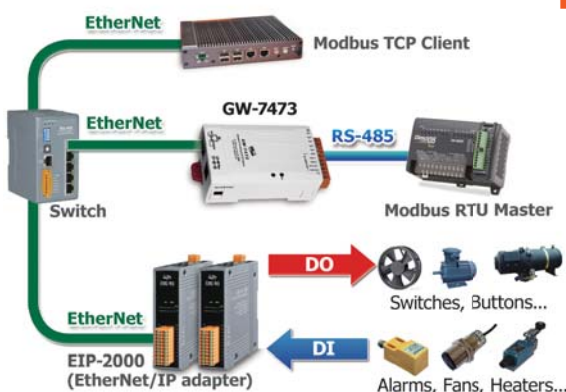



## 6.2 BACnet Gateways

Model Name	Description
<b>BACnet/IP Gateway</b>	GW-5492 BACnet/IP Server to Modbus RTU Master Gateway
	GW-5493 BACnet/IP Server to Modbus TCP Client Gateway
<b>BACnet/IP I/O Modules</b>	BNET-5304 BACnet/IP I/O Module with 6-Ch AI, 1-Ch AO, 4-Ch DI, 4-Ch DO
	BNET-5310 BACnet/IP I/O Module with 4-Ch AI, 2-Ch AO, 3-Ch DI, 3-Ch DO

### BACnet/IP Server to Modbus Master Gateway

#### GW-5492 GW-5493



GW-5492 and GW-5493 is a fully configurable universal BACnet/IP to Modbus RTU/TCP gateway. The GW-549x includes BACnet/IP Server and Modbus RTU Master (GW-5492) or TCP Client (GW-5493) which is used to make Modbus devices accessible on a BACnet network. BACnet (Building Automation and Control Networking) protocol has been designed specifically to meet the communication needs of building automation and control systems for applications such as heating, ventilating. The GW-549x contains a large number of BACnet objects gives you flexibility in mapping Modbus registers to any combination of BACnet objects. Multiple BIBBs are supported. All the data transfer is configurable using a standard Web browser.

### BACnet/IP I/O Module with 6-Ch AI, 1-Ch AO, 4-Ch DI, 4-Ch DO

#### BNET-5304





The BNET-5304 is a multi-function BACnet/IP module with 6 AI channels, 1 AO channel, 4 DI channels and 4 DO channels. The module contains number of BACnet objects including Device, AI, AO, BI, and BO with multiple BIBBs (DS-RP-B, DS-RPM-B, DS-WP-B, DS-WPM, DS-COV-B...etc.) supported. The modules also feature a built-in web server which allows remote configuration by using a regular web browser for an easy and safe access at any time anywhere.

### BACnet/IP I/O Module with 4-Ch AI, 2-Ch AO, 3-Ch DI, 3-Ch DO

#### BNET-5310







The BNET-5310 is a multi-function BACnet/IP module with 4 AI channels, 2 AO channel, 3 DI channels and 3 DO channels. The module contains number of BACnet objects including Device, AI, AO, BI, and BO with multiple BIBBs (DS-RP-B, DS-RPM-B, DS-WP-B, DS-WPM, DS-COV-B...etc.) supported. The modules also feature a built-in web server which allows remote configuration by using a regular web browser for an easy and safe access at any time anywhere.

Model Name		BNET-5304	BNET-5310
Pictures		Multi-function BACnet/IP Module 	Multi-function BACnet/IP Module 
Communication	Ethernet	10/100 Base-TX	
	Security	ID and Password	
Protocol	BACnet	BACnet/IP	
	BACnet Object	1 Device, 6 AI, 1 AO, 4 BI, 4 BO	1 Device, 4 AI, 2 AO, 3 BI, 3 BO
	BIBB	DS-RP-B, DS-RPM-B, DS-WP-B, DS-WPM, DS-COV-B, DM-DDB-B, DM-DOB-B, DM-DCC-B, DM-TS-B, DM-UTC-B, DM-RD-B	
Analog Input	Channel	6, single-ended	4, differential
	Range	±5 V, 0 ~ 5 V	±10 V
Analog Output	Channel	1	2
	Range	±5 V	±10 V
Digital Input	Channel	4, Dry Contact	3, Dry Contact
Digital Output	Channel	4, Open Collect, Sink	3, Open Collect, Sink

# 6.3 CAN Bus Repeater/Bridge/Switch

The CAN Bus Repeater/Bridge/Switch is used to enhance the signal quality, extend the communication distance, isolate CAN Bus network. ICP DAS provides following products.



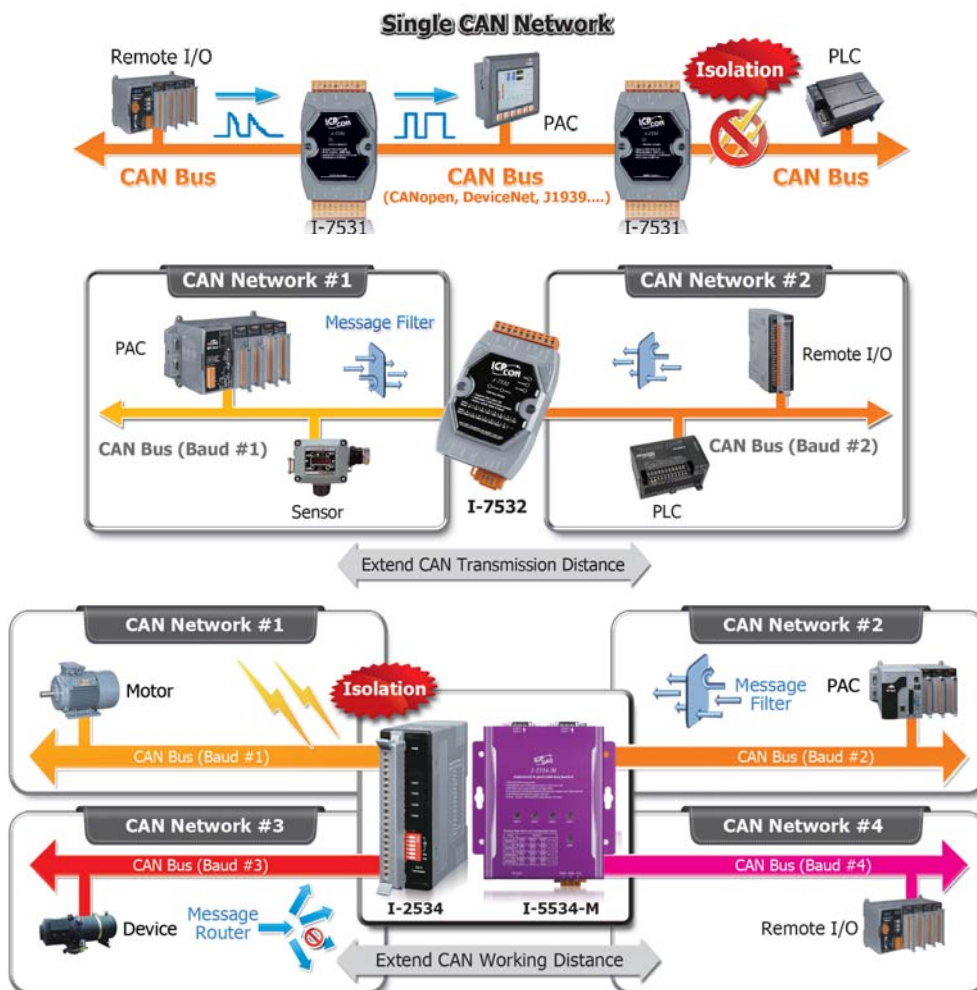



Model Name	I-7531	I-7532	I-2534	I-5534-M
	Isolated CAN Bus Repeater	Isolated Two-channel CAN Bus Bridge	4-Port CAN Bus Switch	4-Port CAN Bus Switch with Metal Casing
Pictures				
<b>CAN Interface</b>				
Transceiver	NXP 82C250		NXP TJA1042	
Channel number	2		4	
Connector	3-pin screwed terminal block (CAN_GND, CAN_L, CAN_H)	4-pin screwed terminal block (CAN_GND, CAN_L, CAN_SHLD, CAN_H)	9-pin male D-Sub with CAN_GND, CAN_SHLD, CAN_H, CAN_L	
Transmission speed (bps)	5 k ~ 800 k with auto baud rate detection	5 k ~ 1 M selected by rotary switch or utility tool		
Transmission Distance (m)	Depends on the CAN baud rate	Duplicates the transmission distance depended on the CAN baud rate		
Propagation Delay	Max. 200 ns (shortens the transmission distance by ~ 40 m)	Depends on the CAN baud rate (Max. 134 us @ 1 Mbps)	Depends on the CAN baud rate (Max. 440 us @ 1 Mbps)	
Terminator Resistor	Jumper for 120 Ω terminator resistor		DIP switch for the 120 Ω terminator resistor	Jumper for 120 Ω terminator resistor
Isolation	3000 Vdc for DC-to-DC, 2500 Vrms for photo-couple			
Specification	ISO 11898-2, CAN 2.0A and CAN 2.0B			







## 6.4 USB to CAN Converters



The I-7565 series is the USB to CAN converter with a maximum of two independent CAN channels that supports CAN protocols 2.0A and 2.0B. It becomes very convenient and easy to access and control the CAN devices via the USB port of the PC.

Model Name	I-7565	I-7565-H1	I-7565-H2	I-7565M-HS	I-7565-CPM	I-7565-DNM
Pictures	1-Port Cost Effective USB to CAN Converter 	1-Port High Performance USB to CAN Converter 	2-Port High Performance USB to CAN Converter 	2-Port High Performance USB to CAN Converter 	Intelligent USB to CANopen Converter 	Intelligent USB to DeviceNet Converter 
<b>USB Interface</b>						
Connector	USB Type B					
Compatibility	USB 1.1 and 2.0 standard					
<b>Compatibility</b>						
Channel	1	1	2	2	1	1
Transceiver	Philips 82C250	NXP TJA1042			NXP 82C250	NXP 82C250
Connector	9-pin male D-Sub		10-pin terminal block	8-pin terminal block	9-pin male D-Sub	
Baud Rate (bps)	10 k, 20 k, 50 k, 100 k, 125 k, 250 k, 500 k, 800 k, 1M					125 k, 250 k, 500 k
Isolation	3000 Vrms				3000 VDC	
Terminator Resistor	Selectable 120 Ω terminator resistor by a jumper					
Protocol	CAN 2.0A/2.0B				CiA 301 V4.02	DeviceNet Volume I ver2.0, Volume II ver2.0
Receive Buffer (frame)	1000	256	128 for each CAN port	256 for each CAN port	1000	256
Max. Data Flow (fps)	250	3000	1500 fps for each CAN port	10000 fps for each CAN port	-	-

## 6.5 CAN to Fiber Converter/Bridge

Models	I-2532	I-2533	I-2533CS	I-2533CS-60	I-2533CS-A/I-2533CS-B
Pictures	CAN to Multi-mode Fiber Converter 		CAN to Single-mode Fiber Bridge    		
<b>CAN Interface</b>					
Connector	Screwed terminal block (CAN_GND, CAN_L, CAN_H)				
Baud Rate (bps)	10 k ~ 500 k	10 k ~ 1 M			
Transmission Distance (m)	Depends on baud rate				
Propagation Delay	Max 125 ns	Max. 125 μs (depends on the CAN baud rate)			
Terminator Resistor	DIP switch for the 120 Ω terminator resistor				
Isolation	3000 VDC for DC-to-DC, 2500 Vrms for photo-couple				
Specification	ISO 11898-2, CAN 2.0A and CAN 2.0B				
<b>Fiber Interface</b>					
Connector	ST Type		SC Duplex (Single-mode)		SC Type
Wave Length (nm)	850		1300 or 1310		TX: 1310, RX: 1550 for I-2533CS-A TX: 1550, RX: 1310 for I-2533CS-B
Fiber Cable (μm)	Multi-mode 50/125, 62.5/125 or 100/140		Single-mode 8.3/125, 8.7/125, 9/125 or 10/125		
Transmission Distance	Max. 1.4 km	Max. 2 km	Max. 30 km	Max. 60 km	Max. 15 km
<b>UART Interface</b>					
COM1	RS-232 (for configuration)				
COM 1 Connector	3-pin screwed terminal block (Rx, Tx, GND)				
Transmission Speed (bps)	115200				
Data bit	8				
Stop bit	1				
Parity	None				



# 6.6 Ethernet/Wi-Fi to CAN Converters

Model Name	Description	
Ethernet/Wi-Fi to CAN Converter	I-7540D-MTCP	Modbus TCP to CAN Converter
	ECAN-240	Modbus TCP Client/Server to two CAN ports Gateway
	I-7540D	Ethernet to CAN Converter
	I-7540D-WF	Wi-Fi to CAN Converter

## Modbus TCP to CAN Converter

### I-7540D-MTCP



Inheriting to the most of all features of the I-7540D, the I-7540D-MTCP enables CAN networks to be combined with the Internet/Ethernet. It can be used to not only access the CAN network via the Ethernet, but can also realize Ethernet transparent transmission on the CAN network. In order to connect the PLCs, HMIs and SCADAs with the CAN devices more easily and conveniently, the I-7540D-MTCP supports the Modbus TCP and Modbus RTU communication protocol. This module can act as a Modbus TCP server, and wait for the commands from the Modbus TCP client. When the controller is a Modbus RTU master, the I-7540D-MTCP is able to be the Modbus RTU slave, and transfer the Modbus RTU commands to the CAN messages. These features mean that users can setup their applications more flexibly and conveniently.

- Compatible with CAN specification 2.0 parts A and B
- Fully compatible with the ISO 11898-2 standard
- Supports a range of baud rates from 10 kbps ~ 1 Mbps
- Support maximum 24 Ethernet clients connection
- Support 30 specific CAN IDs in the Modbus TCP/RTU mode
- Provide the transparent communication between the CAN devices via Ethernet
- Provides one channel each for CAN, RS-232, RS-485 and 10/100 Base-T Ethernet



NEW

## Modbus TCP Client/Server to two CAN ports Gateway

### ECAN-240



ECAN-240 is a Ethernet to CAN two ports Gateway. Users can communicate with different CAN networks at the same time. In order to be used more easily in industry, the ECAN-240 supports Modbus TCP client and Modbus TCP server function. Users can choose one of them for fitting their application. Furthermore, the two CAN ports have different purposes according to their usages. For example: In pair connection mode, the different CAN networks can be communicated with each other via module configuration.



## Ethernet to CAN Converter

### I-7540D



The I-7540D is a CAN to Ethernet converter, and is usually applied as an Ethernet to CAN/RS-232/485 Device Server. It supports socket access functions and virtual COM port technology which helps users to get the CAN, RS-232, RS-485 data via virtual COM port. The I-7540D also provides transparent mode, which enables CAN networks to be coupled together over the Internet/Ethernet, whereby remote monitoring and control is possible. By the features of tiny operating system, protocol independence, small casing and flexibility, it is able to widely fit various RS-232, RS-485 and CAN applications, which may be based on private RS-232 protocol, private CAN protocol, Modbus RTU protocol, CANopen protocol, DeviceNet protocol or J1939 protocol.

- Provide the transparent communication between the CAN devices via Ethernet
- Provide one channel each for CAN, RS-232, RS-485 and Ethernet
- Provides connections for a maximum of 25 Ethernet clients
- Supports a range of baud rates from 10 kbps ~ 1 Mbps
- Jumper for the 120 Ω terminator resistor of the CAN bus
- Compatible with CAN specification 2.0 parts A and B
- 2500 Vrms photocoupler isolation on the CAN side
- Fully compatible with the ISO 11898-2 standard
- Supports the Virtual COM technology
- 10/100 Base-T Ethernet port

### Extend CAN communication distance

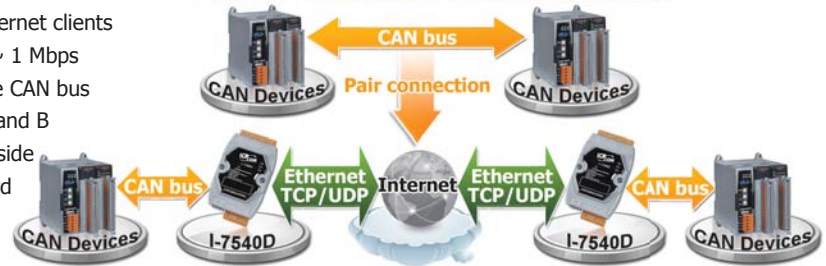

### General Application

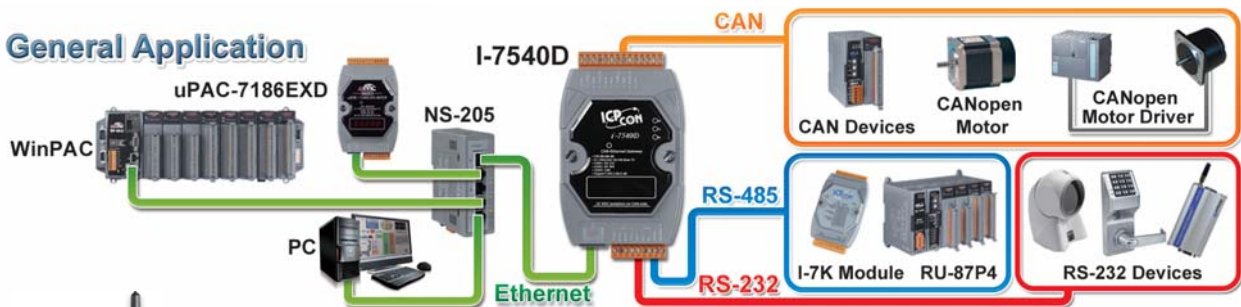

## Wi-Fi to CAN Converter

### I-7540D-WF



The I-7540D-WF supports the wireless transmission of CAN data between a CAN network and a WLAN network according to the 802.11b/g standard. It provides CAN to WLAN converter functionality together with wireless transparent transmission on the CAN network. The I-7540D-WF is highly suitable for connecting mobile (e.g., vehicles or machines) or stationary CAN networks and is often used in short ranges up to 100 m. Using an appropriately configured router, CAN data can be determined to pass or filter from the CAN networks to the Ethernet. The wireless connection that is established between two I-7540D-WF units can be used instead of a cable, and enables the connection of CAN networks that would otherwise be difficult to link such as rotational machineries.

- IEEE 802.11 b/g compliant
- Wireless data transmission via WLAN
- Connects CAN networks via a WLAN bridge
- Compatible with CAN specification 2.0 parts A and B
- Wireless transmission distance: up to 100 meters
- Two different operation modes: infrastructure and ad-hoc
- Supports WEP, WPA and WPA2 encryption for wireless LAN
- Point to point or point to multi-point connection via wireless LAN
- Communication efficiency (peak value): one-way is up to 700 fps (client->server, server->client), two-way 350 fps (client<=>server)



### Ad hoc mode (AP is not necessary)

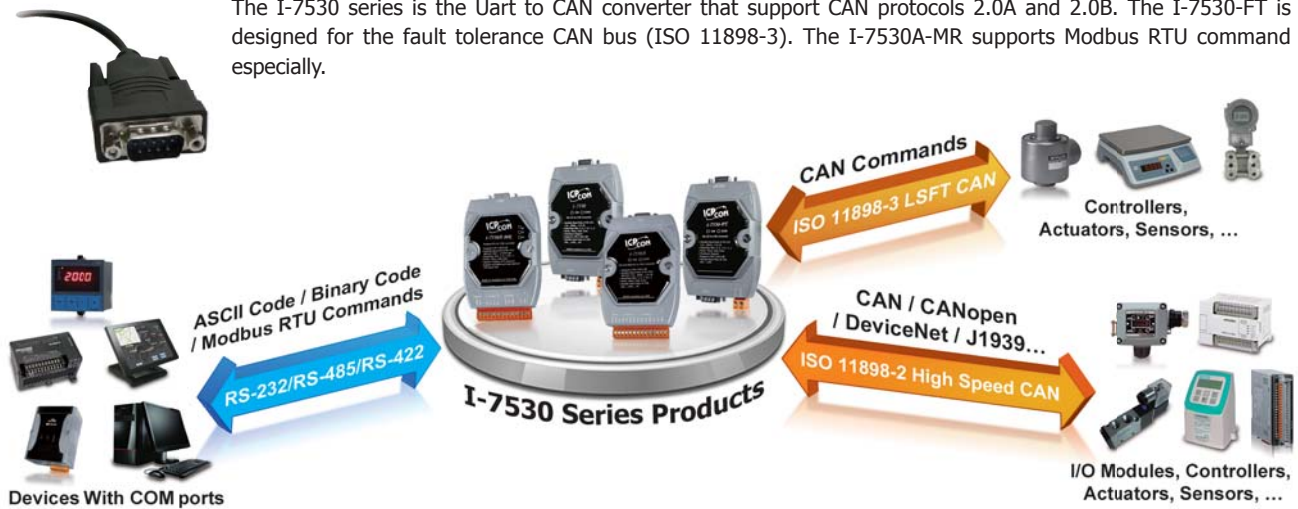

## 6.7 Uart to CAN Converters

The I-7530 series is the Uart to CAN converter that support CAN protocols 2.0A and 2.0B. The I-7530-FT is designed for the fault tolerance CAN bus (ISO 11898-3). The I-7530A-MR supports Modbus RTU command especially.



Models	I-7530-FT	I-7530	I-7530T	I-7530A	I-7530A-MR	tM-7530	tM-7530A	
Pictures	RS-232 to Fault-Tolerance CAN Converter 	RS-232 to CAN Converter 		RS-232/422/485 to CAN Converter 	RS-232/422/485 to CAN Converter 	Modbus RTU to CAN Converter 	Tiny RS-232 to CAN Converter 	RS-232/RS-485/RS-422 to CAN Converter 
<b>CAN Interface</b>								
Transceiver	AMIS 41682	NXP 82C250	TJA1042	NXP 82C250		NXP TJA1042		
Connector	9-pin male D-sub					3 pins spring type terminal block	7-pin terminal block	
Baud Rate	10 k, 20 k, 50 k, 125 k bps	10 k, 20 k, 50 k, 125 k, 250 k, 500 k, 800 k, 1 Mbps						
Protocol	ISO 11898-3 (low speed fault tolerance), CAN 2.0A and CAN 2.0B	ISO 11898-2, CAN 2.0A and CAN 2.0B						
Receiver Buffer	1000 data frames					256 data frames		
Isolation	–	3000 Vdc for DC-to-DC				1000 Vdc for DC-to-DC		
<b>UART Interface</b>								
Type	RS-232			RS-232/422/485		RS-232	RS-232/422/485	
Protocol	–				Modbus RTU slave	–		
Connector	9-pin female D-sub			14-pin terminal block		9-pin female D-sub	10-pin terminal block	
Baud Rate (bps)	110, 150, 300, 600, 1200, 2400, 4800, 9600, 19200, 38400, 57600, 115200				300, 600, 1200, 2400, 4800, 9600, 19200, 38400, 57600, 115200, 230400			
Receiver Buffer	900 data frames					256 bytes		
<b>System</b>								
Power Consumption	1 W							
Power Input	+10 VDC ~ +30 VDC							
Dimensions (W × L × H)	72 × 118 × 33 (mm)					52 × 98 × 27 (mm)	52 × 93 × 27 (mm)	
Operating Temperature	-25°C ~ +75°C							
Storage Temperature	-30°C ~ +80°C							



# 6.8 CANopen Gateways

Model Name	Description	
CANopen Gateway	I-7232D	CANopen Slave to Modbus RTU Master Gateway
	GW-7433D	Modbus TCP/RTU Slave to CANopen Master Gateway
	GW-7553-CPM	PROFIBUS DP Slave to CANopen Master Gateway

## CANopen Slave to Modbus RTU Master Gateway

### I-7232D



The I-7232D is a CANopen slave to Modbus RTU master gateway, and allows a CANopen master to have ability to access the Modbus slave devices. In the CANopen network, the I-7232D is a NMT slave, SDO server, PDO producer, and PDO consumer. From the view of the Modbus network, it is a Modbus RTU master which polls all the predefined data of the Modbus RTU slaves, and bypass the CANopen control commands to the Modbus slaves. The I-7232D follows the CANopen specification CiA-301 v4.02 and CiA-401 v2.1, and supplies many features of CANopen protocols, such as dynamic PDO, EMCY object, error output value, SYNC cyclic and acyclic. An EDS file is also provided by the utility tool. Users can easily apply the I-7232D in the standard CANopen master with the EDS file.

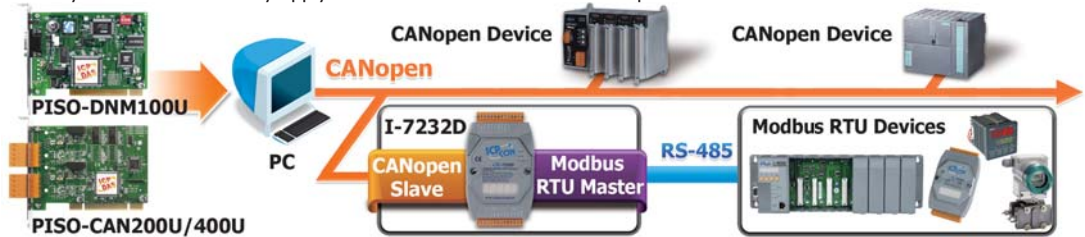

## Modbus TCP/RTU Slave to CANopen Master Gateway

### GW-7433D



The GW-7433D is communication transformation mechanisms between the Modbus protocol and the CANopen protocol. This module is able to collect the information of the CANopen slaves periodically, and returns these data to the Modbus TCP client or Modbus RTU master while receiving the Modbus commands. When the Modbus TCP client or Modbus RTU master needs to output data to the CANopen slaves, the GW-7433D transfers the received Modbus commands to the CANopen messages to handle the CANopen slaves. Both of the Modbus TCP server and the Modbus RTU slave functions can work on the GW-7433D simultaneously. The GW-7433D also offers the Modbus registers for recording the life statuses of the CANopen slaves.

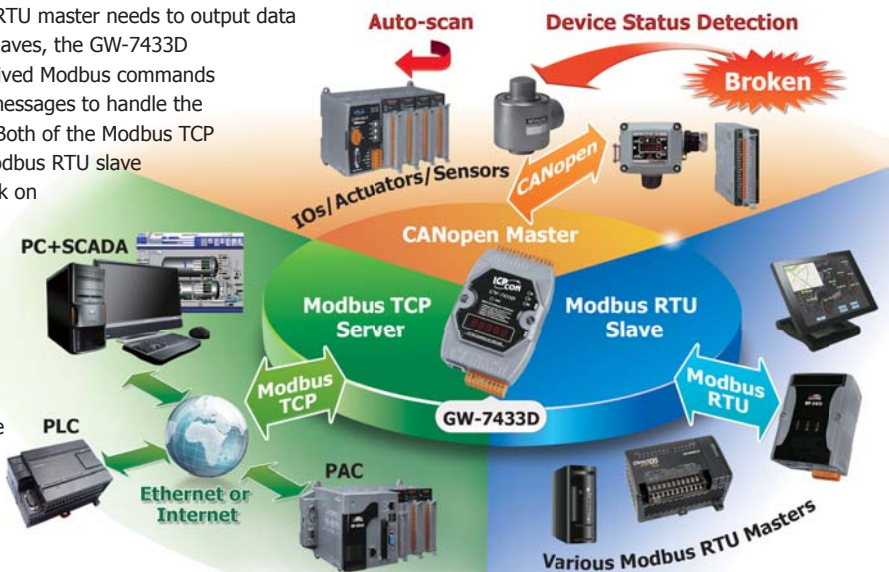

NEW

## PROFIBUS DP Slave to CANopen Master Gateway

### GW-7553-CPM

The GW-7553-CPM is designed for the slave device of PROFIBUS DP protocol. It allows PROFIBUS master to access CANopen slave devices. These CANopen slave device may be a sensor, actuators, ICPDAS CAN-2000 series modules and so forth. In addition, we also provide the utility software for users to configure the GW-7553-CPM.



# 6.9 DeviceNet Gateways

Model Name	Description	
DeviceNet Gateway	I-7242D	DeviceNet Slave to Modbus RTU Master Gateway
	GW-7243D	DeviceNet Slave to Modbus TCP/RTU/ASCII Master Gateway
	GW-7434D	Modbus TCP/RTU Slave to DeviceNet Master Gateway

## DeviceNet Slave to Modbus RTU Master Gateway

### I-7242D



The I-7242D allows a master located on a DeviceNet network to enter into a dialogue with the slaves on a Modbus RTU network. It's a "Group 2 Only Slave" device in the DeviceNet network, and supports "Predefined Master/Slave Connection Set". From the view of the Modbus network, it is a Modbus RTU master which polling all the predefined data of the Modbus RTU slaves, and bypass the DeviceNet control commands to the Modbus slaves. This device is widely used in the application of building automation, remote data acquisition, environment control and monitoring, laboratory equipment & research, factory automation, etc. The I-7242D also has the utility tool which is used to configure the I-7242D's parameters and build the EDS file. Through the EDS file, it is easy to apply the Modbus RTU devices in DeviceNet applications.

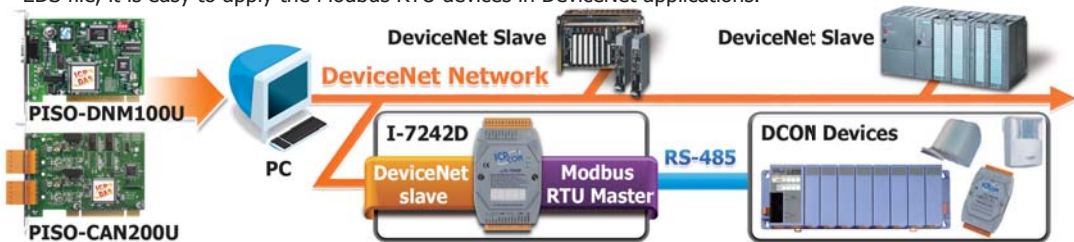

## DeviceNet Slave to Modbus TCP/RTU/ASCII Master Gateway

### GW-7243D



The GW-7243D offers the DeviceNet slave and Modbus master functions, and enables the DeviceNet master to access the Modbus slave devices. In the DeviceNet network, the module acts as a Group 2 Only Server device, and waits to build the connection with the DeviceNet master. In the Modbus network, the GW-7243D is a master device, and cyclically sends the commands to access the Modbus slave devices. Both the Modbus TCP client and Modbus RTU/ASCII master interfaces of the GW-7243D can work simultaneously. This feature means that users are able to integrate different kinds of Modbus slave devices together into the DeviceNet network no matter these devices provide Ethernet, RS-232 or RS-485 communication interfaces. In order to simplify the use of the GW-7243D, the GW-7243D Utility tool for configuration and EDS file production is given to build the applications easily and quickly.

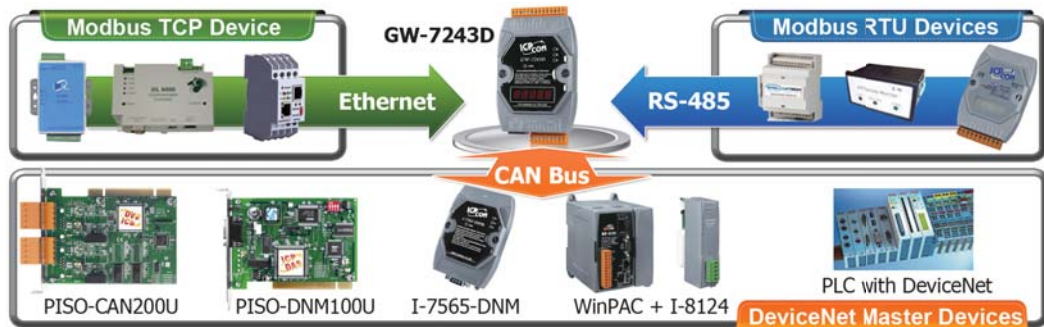

## Modbus TCP/RTU Slave to DeviceNet Master Gateway

### GW-7434D



The GW-7434D is a communication protocol transformation between the DeviceNet protocol and the Modbus TCP protocol. This module solves the problem to connect an existing DeviceNet network to the Ethernet-based PLC, HMI or SCADA for setting up a control or monitoring system. Different to the GW-7243D, the GW-7434D offers the Predefined Master connection Set function and Group 2 only Server function as a DeviceNet master, and enables accessing the DeviceNet slaves automatically and cyclically. If the PLC, HMI or SCADA would like to access the DeviceNet slaves and simultaneously communicate with the Modbus slaves or COM-based devices connected with the RS-232 or RS-485 ports of the GW-7434D, the GW-7434D can be the Modbus TCP server or VxComm server to exchange the data with those devices.

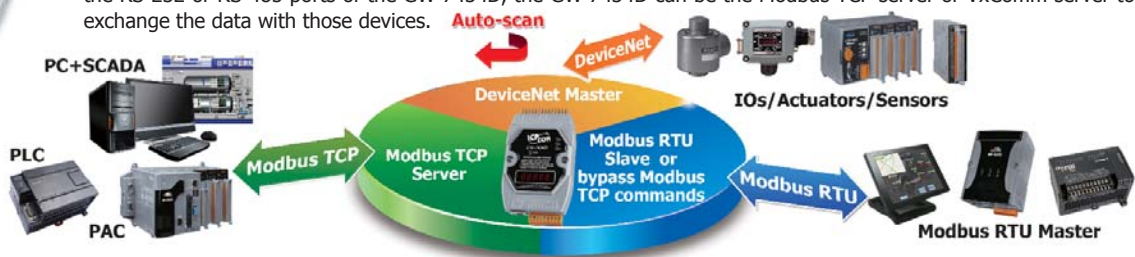



## 6.10 J1939 Gateways

J1939 is the vehicle bus standard used for communication and diagnostics among vehicle components, originally by the car and heavy duty truck industry in the United States. Because of the success of applying in vehicles, J1939 has become the accepted industry standard and the vehicle network technology of choice for off-highway machines in applications such as construction, material handling, and forestry machines. It is a higher-layer protocol based on Controller Area Network (CAN), which provides serial data communications between microprocessor systems (ECU) in any kind of heavy duty vehicles.

Model Name	Description
<b>J1939 Gateway</b>	GW-7228 Modbus RTU Slave to J1939 Gateway
	GW-7238D Modbus TCP/RTU Slave to J1939 Gateway

### Modbus RTU Slave to J1939 Gateway

#### GW-7228



The GW-7228 enables the Modbus RTU master to exchange the data with the devices in the J1939 network. This module provides the Modbus slave functions on the RS-232, RS-422, and RS-485 ports so that the Modbus RTU master can easily control and monitor the J1939-based devices. If users use one of the communication ports for application, the other two ports can be used to monitor the Modbus communication situations between the Modbus master and the GW-7228. This feature is helpful for diagnosis while setting up an application system. For J1939 CAN networks, the GW-7228 supports PDU1, PDU2, broadcast and destination specific type of J1939 messages, and is widely applied in the Diesel power-train, in-vehicle networks for trucks and buses or where the Modbus RTU and J1939 protocols transformation is needed.

- Transmission and reception of all types of J1939 messages, including PDU1, PDU2, broadcast and destination specific
- Support Modbus RTU slave protocol with function codes 03, 04, 06 and 16
- Support BAM of Connection Management message
- Provide PWR/J1939/MODBUS indication LED
- Support RS-232, RS-485 and RS-422 interfaces
- Built-in jumper to select 120 Ω terminal resistor



### Modbus TCP/RTU Slave to J1939 Gateway

#### GW-7238D



Similar to the GW-7228, the GW-7238D is a J1939 to Modbus master gateway. The main difference is that the GW-7238D has an Ethernet port as the Modbus TCP server, and allows connecting with up to 5 Modbus TCP clients. The GW-7238D also offers an RS-232 and RS-485 ports which are the Modbus RTU slaves and enable the Modbus RTU master to exchange the data with the devices in the J1939 network. Both the Modbus TCP server and the Modbus RTU slave functions of the GW-7238D can work simultaneously. This feature means that users can apply the GW-7238D in their applications more flexibly and more economically. For J1939 CAN networks, the GW-7238D supports PDU1, PDU2, broadcast and destination specific type of J1939 messages, and is widely applied in the various J1939-based applications.

- Transmission and reception of all types of J1939 messages, including PDU1, PDU2, broadcast and destination specific
- Support Modbus TCP server/RTU slave protocol with function code 03, 04, 06 and 16
- Communication support both Modbus TCP/RTU to J1939 at the same time
- Support BAM of Connection Management message
- Provide PWR/J1939/MODBUS/ERR indication LEDs
- Support RS-232, RS-485 and Ethernet interfaces
- Built-in jumper to select 120 Ω terminal resistor

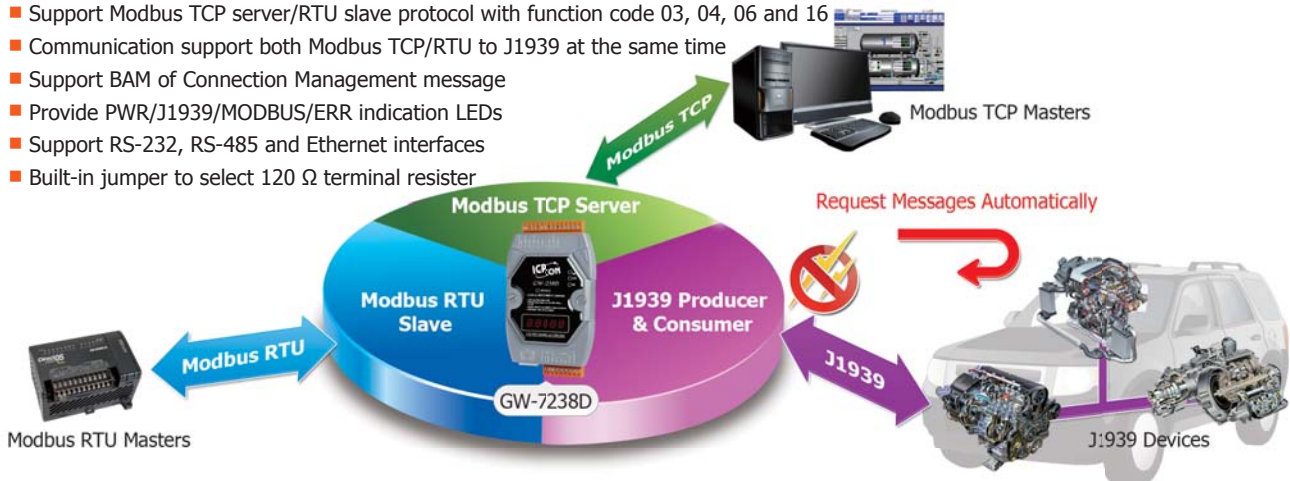





## 6.11 CAN Bus Data Logger

The CAN bus data logging device serves for logging of communication over the CAN data bus. Each received data packet is given a specific time mark, which shows the precise arrival time of data. The actual time mark is obtained from the internal real time clock (RTC), therefore it is independent of the global system time. Data logging on a common SD card allows further analysis and system monitoring on a PC. The CAN-Logger100/200 device by ICP DAS is the result of extensive CAN bus testing and CAN bus programming and is suited for all type of CAN bus application.



Models	CAN-Logger100	CAN-Logger200
Pictures		
<b>CAN Interface</b>		
Transceiver	NXP TJA1042	
Channel Number	1	2
Connector	5-Pin male M12 × 1 (Pin 1: F.G., Pin 2: +Vs, Pin 3: GND, Pin 4: CAN_H Pin 5: CAN_L)	5-Pin male M12 × 2 (Pin 1: F.G., Pin 2: +Vs, Pin 3: GND, Pin 4: CAN_H Pin 5: CAN_L)
Transmission Speed (bps)	10 k, 20 k, 50 k, 100 k, 125 k, 250 k, 500 k, 800 k, 1 M and user-defined baud rate	
Terminator Resistor	DIP switch for the 120 Ω terminator resistor	
Isolation	3000 VDC for DC-to-DC, 2500 Vrms for photocoupler	
Specification	ISO-11898-2, CAN 2.0A and CAN 2.0B	
CAN Filter	Utility tool	
<b>USB Interface</b>		
Connector	USB Type B × 1	
Compatibility	USB 2.0 High Speed	
Max. Data flow	Transmit: 4000 fps ; Receive: 1000 fps	
Software Driver	Windows 2K/XP/7/8	
<b>Data Logger Capability</b>		
Storage Media	SDHC type flash – support 4 to 32 GB	
Recording Format	Binary	
Time Stamp Resolution	10 us	
Configuration	Utility tool	
Trigger	Log continuously	
Data Logger	Maximum message rate, receive: 15000 msgs/s	
<b>LED</b>		
Round LED	Power, MS, SD, CAN1, CAN2, CAN_ST LEDs	Power, MS, SD, CAN_Rx, CAN_Tx, CAN_ST LEDs
<b>Power</b>		
Power Supply	USB power or CAN bus power (Unregulated +10 ~ +30 VDC) delivery	
Protection	Power reverse polarity protection, Over-voltage brown-out protection	
Power Consumption	0.1 @ 24 Vdc	
<b>Mechanical</b>		
Installation	DIN-Rail	
Casing	Metal	
Dimensions (W × L × H)	102 mm × 102 mm × 44 mm	
<b>Environment</b>		
Operating Temperature	-25°C ~ +75°C	
Storage Temperature	-30°C ~ +80°C	
Relative Humidity	10 ~ 90% RH, Non-condensing	

NEW

### USB to 1-port CAN bus data logger device

#### CAN-Logger100



The CAN-Logger100 is a high-performance intelligent CAN bus data logger device with one CAN port that can help to make data collection and to process on a CAN bus network easier and quicker. The powerful CPU of the CAN-Logger100 provides the accurately time-stamp for each CAN message and supports storage media like MMC, SD or SDHC type flash for saving these CAN messages that is useful to analysis and diagnostic the CAN network. In order to enhance the portability of the CAN-Logger100, this module is powered by the USB interface or a M12 connector of CAN bus interface. The CAN-Logger100 uses the standard USB driver of the Windows system. Operating systems supported include Windows 2K/XP/7/8.

- Provides one CAN port
- Power by the USB port or CAN port
- 3 kV galvanic isolation for the CAN port
- Full compatible with the ISO 11898-2 standard
- 2500 Vrms photocoupler isolation on the CAN side
- Supports CAN bus acceptance filter configuration
- Compatible with CAN specification 2.0 parts A and B
- Programmable CAN bus baud rate from 10 kbps ~ 1 Mbps
- Built-in jumper for the 120 Ω terminal resistor of the CAN side
- Supports 4 to 32 GB SDHC type flash for saving CAN messages
- CAN messages are time-stamped with 10 microseconds resolution
- Provides a configuration utility that can be used to transmit/receive CAN messages

NEW

### USB to 2-port CAN bus data logger device

#### CAN-Logger200



The CAN-Logger200 is a high-performance intelligent CAN bus data logger device with two CAN port that can help to make data collection and to process on a CAN bus network easier and quicker. The powerful CPU of the CAN-Logger200 provides the accurately time-stamp for each CAN message and supports storage media like MMC, SD or SDHC type flash for saving these CAN messages that is useful to analysis and diagnostic the CAN network. In order to enhance the portability of the CAN-Logger200, this module is powered by the USB interface or M12 connectors of CAN bus interface. The CAN-Logger200 uses the standard USB driver of the Windows system. Operating systems supported include Windows 2K/XP/7/8.

- Provides two CAN port
- Power by the USB port or CAN port
- 3 kV galvanic isolation for the CAN port
- Full compatible with the ISO 11898-2 standard
- Supports CAN bus acceptance filter configuration
- 2500 Vrms photocoupler isolation on the CAN side
- Compatible with CAN specification 2.0 parts A and B
- Programmable CAN bus baud rate from 10 kbps ~ 1 Mbps
- Built-in jumper for the 120 Ω terminal resistor of the CAN side
- Supports 4 to 32 GB SDHC type flash for saving CAN messages
- CAN messages are time-stamped with 10 microseconds resolution
- Provides a configuration utility that can be used to transmit/receive CAN messages

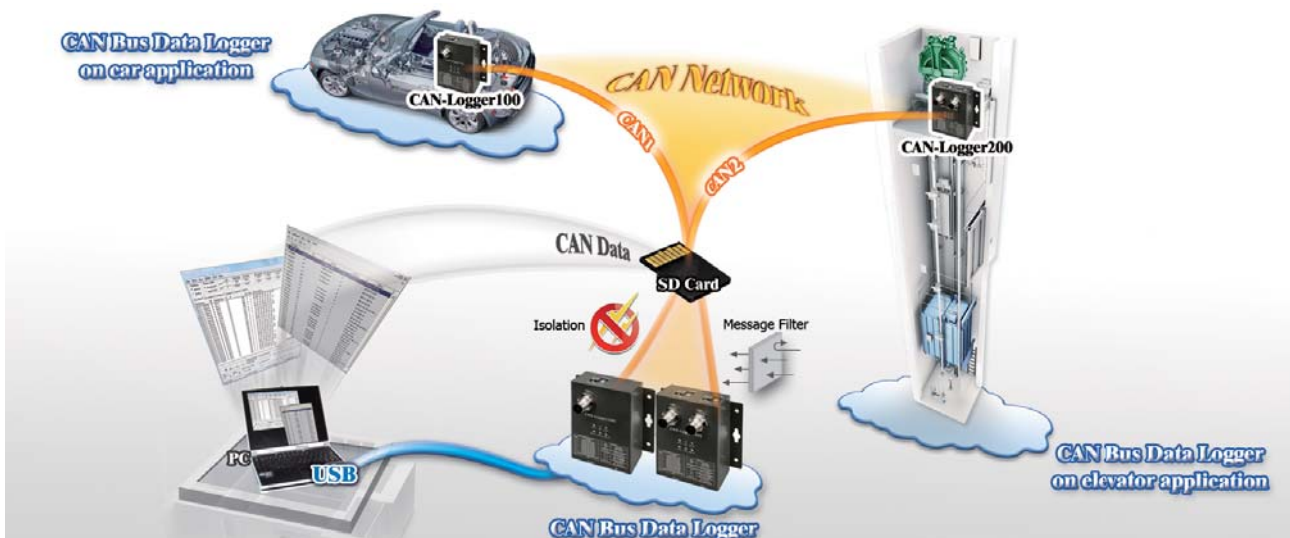

# 6.12 PC-based CAN Bus Boards

To access the CAN sensors, actuators, and I/O modules we provide communication boards for PC-based solution.

### Communication Boards:

The following CAN bus communication boards are designed for different interface and different CAN port number. The common features are:

1. Compatible with CAN specification 2.0 parts A and B
2. Fully compatible with ISO 11898-2 standard
3. Supports baud rate from 10 kbps to 1 Mbps
4. 2 kV galvanic isolated
5. Direct memory mapping to the CAN controller

### Software Support:





#### ► For Windows:



- ✓ LabVIEW CAN Driver
- ✓ DASyLab CAN Driver
- ✓ RTX CAN Driver
- ✓ PISOCNX Active Object
- ✓ NAPOPC.CAN DA Server
- ✓ InduSoft Driver
- ✓ Power Meter Driver

#### ► For Linux:

- ✓ SocketCAN Device Driver

## PC-based CAN Communication Boards

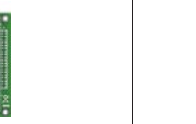
Model Name	PEX-CAN200i	PISO-CAN100U	PISO-CAN200U	PISO-CAN400U	PISO-CAN800U
Pictures					
CAN Channel	2	1	2	4	8
Bus Interface	<b>X1 PCI Express</b>	<b>Universal PCI</b>			
On-board CPU	-				
Baud Rate	Programmable transfer rate up to 1 Mbps				
Terminator Resistor	Jumper for 120 Ω terminator resistor				
Galvanic Isolation	2 kV				
PC APIs	API for VB, VC, BCB, VB.Net, C#.Net				
RTX Driver	Yes				-
LabVIEW Driver	Yes				-
InduSoft Driver	Yes				-
OPC Server	Yes				-
OCX	Yes				-
SocketCAN Driver	Yes				-
Device Driver	Windows XP/7/8.1/10, Linux				Windows XP/7

Model Name	PCM-CAN100	PCM-CAN200	PCM-CAN200P
Pictures			
CAN Channel	1, and the other for bypass	2	
Bus Interface	<b>PCI-104</b>		<b>PC/104-Plus</b>
On-board CPU	-		
Baud Rate	Programmable transfer rate up to 1 Mbps		
Terminator Resistor	Jumper for 120 Ω terminator resistor		
Galvanic Isolation	2 kV		
PC APIs	API for VB, VC, BCB, VB.Net, C#.Net		
RTX Driver	Yes		
LabVIEW Driver	Yes		
InduSoft Driver	Yes		
OPC Server	Yes		
OCX	Yes		
SocketCAN Driver	Yes		
Device Driver	Windows XP/7/8.1/10, Linux		



Model Name	PISO-CM100U	PISO-CM200U	PCM-CM100	PISO-DNM100U	PISO-DNS100U	PISO-CPM100U	PCM-CPM100
Pictures							
CAN Channel	1	2			1		
Bus Interface	Universal PCI		PCI-104		Universal PCI		PCI-104
On-board CPU	Yes						
On-board CPU OS	MiniOS7	-			MiniOS7		
On-board CPU APIs	C/C++	-	C/C++		-		
Default Firmware	CAN 2.0A/2.0B			DeviceNet Master	DeviceNet Slave	CANopen Master	
EDS File Support	-					Yes	
Baud Rate	Programmable transfer rate up to 1 Mbps			125 k, 250 k, and 500 kbps		10 k, 20 k, 50 k, 125 k, 250 k, 500 k, 800 k, 1 Mbps	
Terminator Resistor	Jumper for 120 Ω terminator resistor						
Galvanic Isolation	2 kV	3 kV			2 kV		
PC APIs	API for VB, VC++, BCB, Delphi	API for VB.Net, C#.Net, VC++.Net	API for VB, VC++, BCB, Delphi		API for VB, VC++, VB.Net, C#.Net		
LabVIEW Driver		-		Yes		-	
InduSoft Driver	Yes	-		Yes	-		Yes
Power Meter Driver	Yes	-	Yes		-		Yes
Device Driver	Windows XP/7/8.1/10, Linux	Windows XP/7/8.1/10			Windows XP/7/8.1/10, Linux		

**Connector Types: -T/-D**

Each CAN bus board provide two type of connectors and, DB9 and Terminal Block.



PISO-xxxxx-D

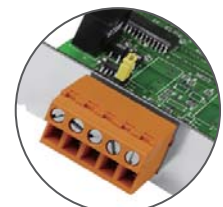

PISO-xxxxx-T

**Accessory:**

**Optional Cable for PISO-CAN800U**

**CA-9-3705:**

DB-37 Male (D-sub) to 4-Port DB-9 Male (D-sub) cable. 0.3 M (90°)



**CA-9-3715D:**

DB-37 Male (D-sub) to 4-Port DB-9 Male (D-sub) cable. 1.5 M (180°)



**Optional CAN bus connector: CNT-CAN**

**CA-0910-C**

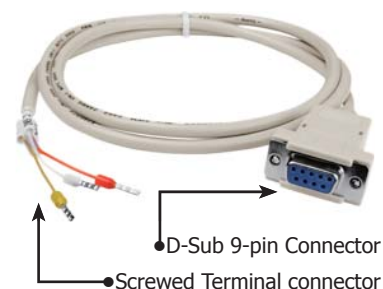
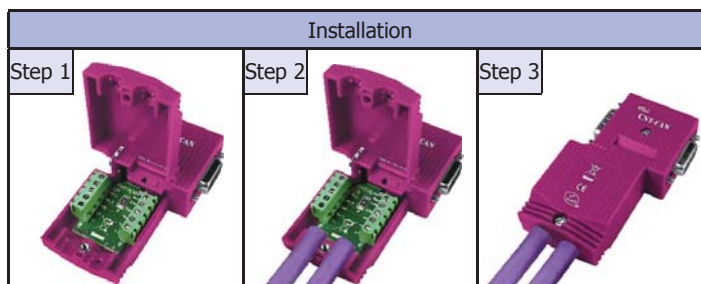

## CAN bus boards

The PCI and PCI Express CAN bus boards use the new CAN controller Phillips SJA1000T and transceiver TJA1042, which provide bus arbitration, error detection with auto correction and re-transmission function. It can be installed in a 5V or 3.3V PCI slot and supported truly "Plug & play".

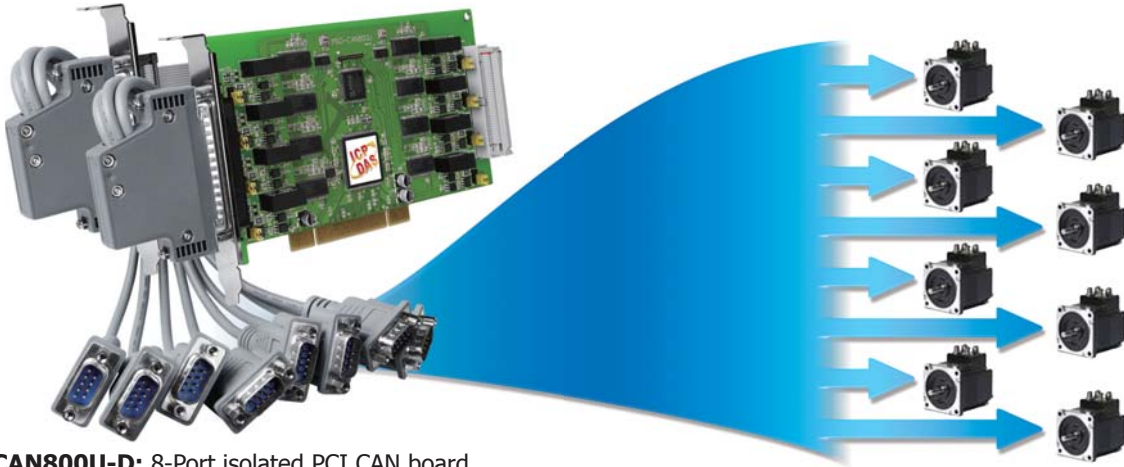

**PISO-CAN800U-D:** 8-Port isolated PCI CAN board

### Common Features:

- Universal PCI card, supports both the 5 V and the 3.3 V PCI bus
- Compatible with CAN specification 2.0 parts A and B
- Fully compatible with the ISO 11898 -2 standard
- Support a range of baud rates from 10 kbps ~ 1 Mbps
- VB, VC++, Delphi, and Borland C++ builder demos are provided
- Built-in jumper for the 120 Ω terminator resistor of the CAN bus
- 2500 Vrms photocoupler isolation on the CAN side
- Provide 1/2/4/8 independent CAN channels
- 2 kV galvanic isolation for each CAN port
- Direct memory mapping to the CAN controller
- Supports LabVIEW and DASyLab drivers

## PISO-CM100U, PCM-CM100: CAN board with built-in programmable CPU

As a stand-alone CAN controller, the PISO-CM100U/PCM-CM100 represents a powerful and economic solution. It has an internal 16-bit 80186 compactable CPU for the complex protocol interpretations and implementations. Owing to the real-time DOS-like OS, MiniOS7, the PISO-CM100U/PCM-CM100 can cover most of all time-critical CAN-based applications, such as self-define CAN protocol, CANopen, DeviceNet, J1939, and so forth. Therefore, when users develop their projects, the PISO-CM100U/PCM-CM100 is helpful to handle the process of the CAN messages, and share the CPU loading of the PC or embedded system. Besides, the PISO-CM100U/PCM-CM100 allows users designing the firmware of the PISO-CM100U/ PCM-CM100. Through the library and demos, it is easy to finish the user-defined firmware to satisfy the users' requirements.

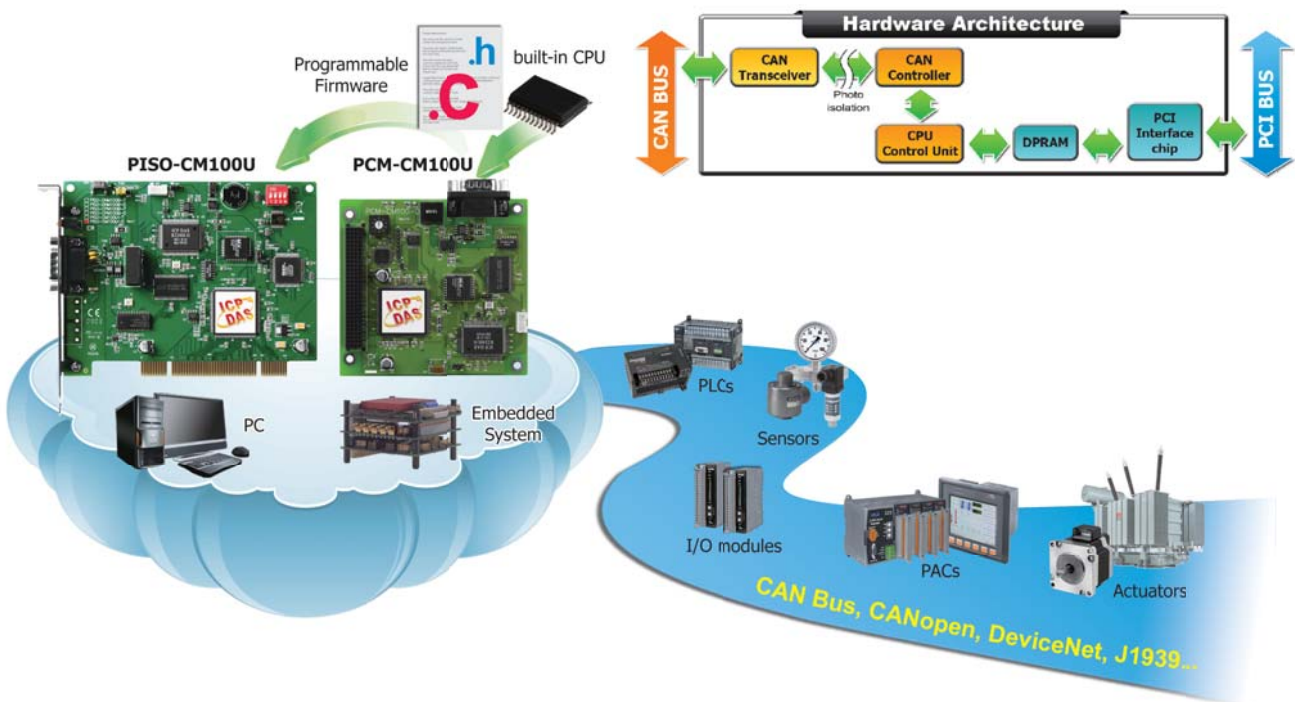

## 6.13 Palm-size Programmable CAN Controllers

The palm size PACs (Programmable Automation Controller) includes I-7188XBD-CAN, uPAC-7186EXD-CAN and uPAC-5001D-CAN2. With abundant and various peripherals and communication ports, the PAC can integrate different communication interface, like CAN bus, RS-232, RS-485, Ethernet and so on. In order to increase the modules openness and applications flexibility, the PAC provides MiniOS7, a DOS-like real-time single-task operation system for adapting to all kinds of needs. Users can develop application programs via C/C++ compiler.

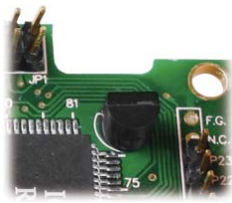

**Unique 64-bit Hardware Serial Number**



**Built-in RTC - Real Time Clock**



**5-Digit 7-Segment LED Display**



**microSD expansion**

Model Name	I-7188XBD-CAN	uPAC-7186EXD-CAN	uPAC-5001D-CAN2
Pictures			
<b>System Software</b>			
OS	MiniOS7 (DOS-like embedded operating system)		
<b>Development Software</b>			
Download Interface	RS-232 (COM1) or Ethernet		
Language	C language		
Compilers	TC++ 1.01, TC 2.01, BC++3.1 ~ 5.2x, MSC 6.0, MSVC++ (before version 1.5.2)		
<b>CPU Module</b>			
CPU	80188, 40 MHz or compatible	80186, 80 MHz or compatible	
SRAM	512 KB	512 KB	512 KB
Flash	512 KB	512 KB	512 KB
microSD Expansion	-		Up to 2 GB
EEPROM	2 KB	16 KB	
NVRAM	31 Bytes (battery backup, data valid up to 10 years)		
RTC (Real Time Clock)	Provide second, minute, hour, date, day of week, month, year		
64-bit Hardware Serial Number	Yes, for Software Copy Protection		
Watchdog Timers	Yes (0.8 second)		
<b>Communication Ports</b>			
Ethernet	-	10/100 Base-TX (Auto-negotiating, Auto MDI/MDI-X, LED indicators)	
COM 1	RS-232 (TxD, RxD, RTS, CTS, GND) or RS-485 (Data+, Data-), non-isolated	RS-232 (TxD, RxD, RTS, CTS, GND), non-isolated	
COM 2	RS-485 (Data+, Data-) with internal self-tuner ASIC; non-isolated		
CAN	1 channel	1 channel	2 channels
<b>LED Indicator</b>			
7-Segment LED	Yes		
Programmable LED Indicators	4		5
<b>Mechanical</b>			
Dimension (W × L × H)	72 mm × 122 mm × 33 mm		91 mm × 123 mm × 52 mm
Installation	DIN-Rail Mounting		
<b>Environmental</b>			
Operating Temperature	-25 ~ +75°C		
Storage Temperature	-30 ~ +80°C		
Ambient Relative Humidity	10 ~ 90% RH (non-condensing)		
<b>Power</b>			
Input Range	10 ~ 30 VDC		12 ~ 48 VDC
Redundant Power Inputs	-		Yes
Power Consumption	3 W		



## 6.14 PAC-based CAN Modules

These CAN bus communication modules are the solutions to the various CAN application requirements in PAC family with rich CAN bus protocols. The I-8123W, I-87123W, I-8124W, and I-87124W separately support CANopen and DeviceNet master protocols. Users can apply them in PAC to connect to CANopen and DeviceNet devices to reach various CANopen/DeviceNet systems easily.

For the especial CAN bus applications, the I-8120W and I-87120W are designed for users to apply in PAC series. The default firmware of I-8120W and I-87120W provides the transmission and reception of CAN bus messages in PAC. In addition, users can design the specific firmware in these modules to reduce the loading of the PAC in C language.

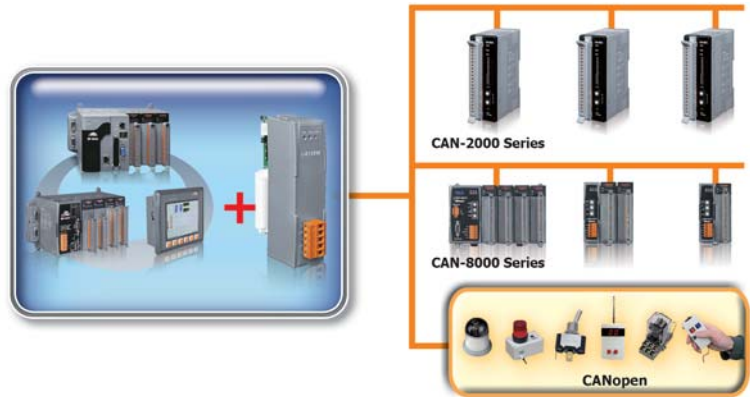

CAN/CANopen/DeviceNet Communication Module (Parallel/Serial Bus)						
Model Name	I-8120W	I-87120	I-8123W	I-87123	I-8124W	I-87124
Pictures						
<b>Communication</b>						
Interface	ISO 11898-2 CAN					
Port	1					
Terminator	120 Ω Selected By Jumper					
Max. Speed (K bps)	1000		1000		500	
Controller Chip	SJA1000T					
Transceiver Chip	82C250					
Protocol	CAN 2.0 A/2.0 B		CANopen CiA 301 ver 4.02, CiA 401 ver 2.1		DeviceNet Volume I ver 2.0, Volume II ver 2.0	
<b>System</b>						
Hot Swap	-	Yes	-	Yes	-	Yes
Data Communication	Parallel Interface	Serial Interface	Parallel Interface	Serial Interface	Parallel Interface	Serial Interface
User-defined Firmware	Yes		-		-	
Isolation	2500 Vrms					
Power Consumption	2 W					
Connector	5-pin Terminal Block					
Optional Accessories	CA-0904 Cable					
 CA-0904						
Model Name	I-8120W	I-87120	I-8123W	I-87123	I-8124W	I-87124
<b>PAC Driver Support</b>						
I-8000, iP-8000	-	BC, TC	-	BC, TC	-	BC, TC
VP-2111						
WP-8000	eVCpp 4.0, VB.Net 2005, C#.Net 2005					
VP-2000						
XP-8000-CE6, XP-8000-Atom-CE6	VB.Net 2005, C#.Net 2005, VC 2005					
XP-8000, XP-8000-Atom	VB.Net 2005, C#.Net 2005, VC 6					
LP-8000	-	GCC	-	GCC	-	GCC

## 6.15 PROFIBUS Converters & Gateways

The PROFIBUS repeater is used to solve the issues of the PROFIBUS segment, transmission distance and disturbance when setting up a PROFIBUS network. If it is necessary to integrate the different communication interface, the PROFIBUS converter is helpful. The application architectures as following figures provide the examples to show when and how to apply these products.

Model Name	Description	
<b>Converters</b>	I-7550	PROFIBUS to RS-232/422/485 Converter
	I-7550E	PROFIBUS to Ethernet Converter
	PROFI-2510	Isolated PROFIBUS Repeater
	PROFI-2541	PROFIBUS to Fiber (ST connector) Converter
	PROFI-2541-SC	PROFIBUS to Fiber (SC connector) Converter
	PROFI-2542-SC	PROFIBUS to Single mode Fiber (SC connector) Converter
<b>Gateway</b>	GW-7552	PROFIBUS DP Slave to Modbus RTU Master Gateway
	GW-7553	PROFIBUS DP Slave to Modbus TCP/RTU Master Gateway
	GW-7553-CPM	PROFIBUS DP Slave to CANopen Master Gateway
	GW-7557	PROFIBUS DP Slave to HART Master Gateway

Model Name	I-7550	I-7550-E	PROFI-2510	PROFI-2541	PROFI-2541-SC	PROFI-2542-SC
Pictures	PROFIBUS to RS-232/422/485 Converter	PROFIBUS to Ethernet Converter	Isolated PROFIBUS Repeater	PROFIBUS to Fiber Converter		
PROFIBUS Channel	1		2	1		
PROFIBUS Baud Rate (bps)	9.6 k ~ 12 M			9.6 k ~ 3 M		9.6 k ~ 12 M
PROFIBUS Protocol	DP-V0 Slave		DP-V0/DP-V1/DP-V2			
PROFIBUS Address	0~126 set by DIP switch		-			
PROFIBUS Transmission Distance (m)	Depend on baud rate					
COM 1	RS-232/RS-485/RS-422	RS-232	-			
COM 1 Baud Rate (bps)	1.2 K ~ 115.2 K	115.2 K	-			
Fiber Channel				1		
Fiber Connector				ST (Multi-mode)	SC (Multi-mode)	SC (Single-mode)
Fiber Transmission Distance (m)				1.4 km Max. (in 62.5/125 μm fiber cable)		10 km (in 9/125 μm fiber cable)
Ethernet Speed	-	10/100M	-			
Ethernet Protocol	-	TCP/UDP Server/Client	-			

### PROFIBUS DP Slave to Modbus TCP/RTU Gateway

#### GW-7552



The GW-7552 gateway is a PROFIBUS DP slave. It allows the PROFIBUS master to access the Modbus RTU devices. In the Modbus network, the GW-7552 can be a master to access the Modbus slaves, or be a slave to provide the data from the PROFIBUS master. The flexible design lets the GW-7552 widely applying in the many applications.

- Protocol PROFIBUS DP-V0 Slave
- Detect transmission rate (9.6 to 12000 kbps) on PROFIBUS automatically
- 132 bytes Max. input data length
- 131 bytes Max. output data length
- Support Modbus master mode and slave mode
- PROFIBUS address 0 ~ 126 set by DIP switch
- Support several kinds of baud for COM1 from 2.4 ~ 115.2 kbps

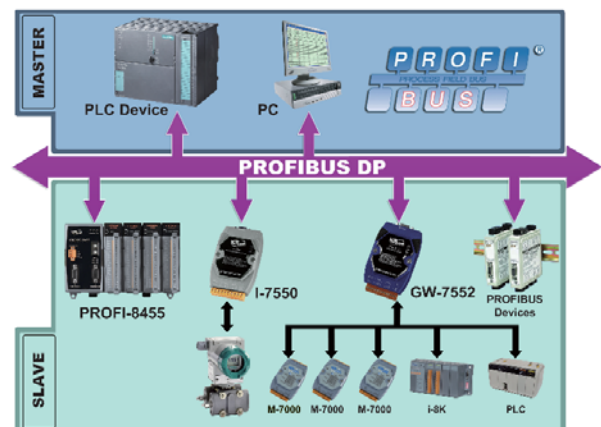

### PROFIBUS DP Slave to Modbus TCP/RTU Gateway

#### GW-7553



The GW-7553 is used for data-exchange between the Modbus TCP/RTU network and the PROFIBUS network. It provides not only the Modbus TCP client and server functions, but the Modbus RTU master and slave functions. Therefore, the GW-7553 can satisfy most of the applications of the data transfer between Modbus and PROFIBUS.

- Protocol PROFIBUS DP-V0 & DP-V1 slave
- Support one 10/100 Base-TX Ethernet port
- Support one RS-232 port
- 240 bytes Max. input data length
- 240 bytes Max. output data length
- Support Modbus TCP/RTU/ASCII protocol
- PROFIBUS address 0 ~ 126 set by DIP switch
- Detect Transmission rate (9.6 to 12000 kbps) on PROFIBUS automatically

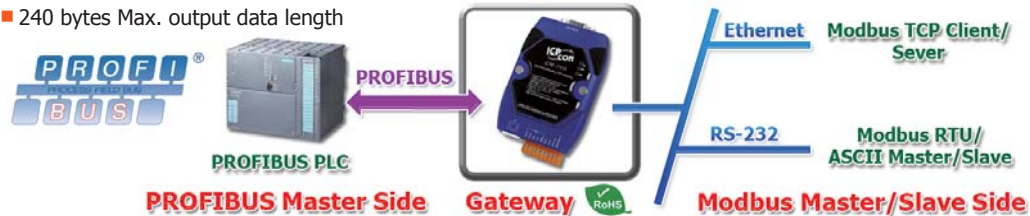

NEW

### PROFIBUS DP Slave to CANopen Master Gateway

#### GW-7553-CPM



The GW-7553-CPM is designed for the slave device of PROFIBUS DP protocol. It allows PROFIBUS master to access CANopen slave devices. These CANopen slave device may be a sensor, actuators, ICPDAS CAN-2000 series modules and so forth. In addition, we also provide the utility software for users to configure the GW-7553-CPM. By using this module, users can put their CANopen slave devices into PROFIBUS network very easily.

- Protocol: PROFIBUS DP-V0 slave
- Support Heartbeat function
- Support Node Guarding
- 240 bytes Max. input data length
- 240 bytes Max. output data length
- Follow the CiA CANopen Standard DS-301 v4.02
- Support 110 CANopen SDO/PDO commands
- PROFIBUS address 0 ~ 126 set by DIP switch
- Detect Transmission rate (9.6 to 12000 kbps) on PROFIBUS automatically



### PROFIBUS DP Slave to HART Master Gateway

#### GW-7557



The GW-7557 is designed for the slave device of PROFIBUS DP protocol. It allows the PROFIBUS master to access the HART slave devices. These HART devices may be a transmitter, an actuator, a current output device and so forth. Owing to the GW-7557, you can communicate the HART slave devices into PROFIBUS network very easily.

- PROFIBUS address 0 ~ 126 set by DIP switch
- Support HART mode: point-to-point/multi-drop
- Protocol: PROFIBUS DP-V0 slave
- Support HART Short/Long frame
- 240 bytes Max. input data length
- 240 bytes Max. output data length
- Support 4 HART channels, each for Max. 15 HART modules
- Detect transmission rate (9.6 to 12000 kbps) on PROFIBUS automatically

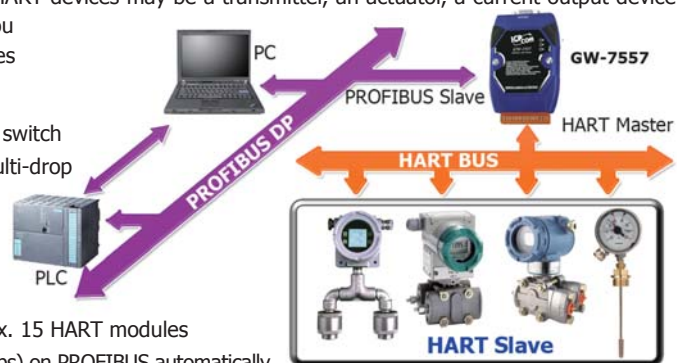

### Application:



Optional PROFIBUS connector: CNT-PROFI



Installation



## 6.16 PROFINET Converters & Gateways

Model Name	Description	
<b>PROFINET Converter</b>	I-7580	PROFINET to RS-232/422/485 Converter
<b>PROFINET Gateway</b>	GW-7662	PROFINET to Modbus RTU/ASCII Gateway
	GW-7663	PROFINET to Modbus TCP Gateway

**NEW**

### PROFINET to RS-232/422/485 Converter

#### I-7580



The I-7580 is specially designed for PROFINET IO device. It offers RS-232, RS-422, and RS-485 three kinds of communication way. With the Hybrid COM 1 design, users can readily choose one type of com port to use. Through the GSDML file, it is easy to communicate with any standard PROFINET IO controller.

- Protocol: PROFINET IO Device
- 512 bytes Max. input data length
- 384 bytes Max. output data length
- Cyclic Time: 1 ms (min)
- Generic GSDML File Provided (Version 2.25)
- PROFINET Conformance Class B and RT Class 1
- 4 kV Contact ESD protection for any terminal



**NEW**

### PROFINET to Modbus RTU Master Gateway

#### GW-7662



The GW-7662 gateway is a PROFINET IO device that allows the PROFINET controller to access the Modbus RTU devices. In the Modbus network, the GW-7662 can be a Modbus master to access the Modbus slaves, can be a Modbus slave provide the data from the PROFINET controller. The flexible design lets the GW-7662 widely applying in the many applications.

- Support several kinds of baud for COM1 from 2.4 ~ 115.2 kbps
- Max length of in/output data is 512/512 Bytes
- PROFINET Conformance Class B and RT Class 1
- Generic GSDML File Provided (Version 2.25)
- Protocol: PROFINET IO Device
- Support Modbus RTU/ASCII protocol
- Support Modbus Master and Slave mode
- Cyclic Time: 1 ms (min)

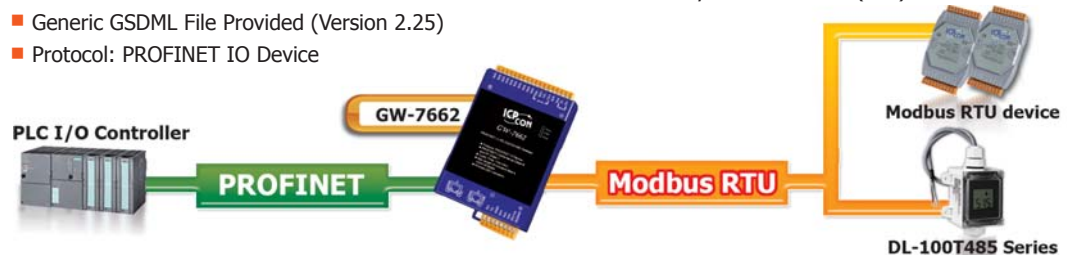

**NEW**

### PROFINET to Modbus TCP Master Gateway

#### GW-7663



The GW-7663 is used for data-exchange between the Modbus TCP network and the PROFINET network. It provides the Modbus TCP client and server functions. Therefore, the GW-7663 can satisfy most of the applications of the data transfer between Modbus and PROFINET.

- Max length of in/output data is 512/512 Bytes
- PROFINET Conformance Class B and RT Class 1
- Generic GSDML File Provided (Version 2.25)
- Protocol: PROFINET IO Device
- Cyclic Time: 1 ms (min)
- Support Modbus TCP protocol
- Support Modbus Master and Slave mode

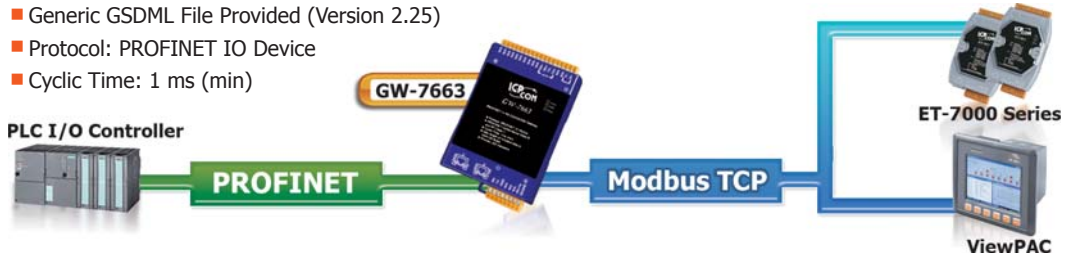

# 6.17 HART Converters, Gateways & Signal Filter

ICP DAS have deeply researched on the HART bus technology for many years. The total HART products have been developed by ICP DAS including HART converter, HART gateway and HART I/O modules. The HART converter can be used to access HART devices via COM, USB or Ethernet interface. The HART gateway can integrate HART communication to the different protocols like Modbus, PROFIBUS etc.

Model Name	Description	
<b>Converter</b>	I-7547	Ethernet to HART Converter
	I-7567	USB to HART Converter
	I-7570	RS-232/422/485 to HART Converter
	HRT-227CS	HART to Single Mode Fiber Converter
	HRT-328-A4	HART-to-Analog Converter and Loop Monitor
<b>Gateway</b>	HRT-710	Modbus RTU/ASCII Slave to HART Master Gateway
	HRT-310	Modbus RTU/ASCII Slave to HART Master Gateway (Upright)
	HRT-711	Modbus TCP Slave to HART Master Gateway
	GW-7557	PROFIBUS DP Slave to HART Master Gateway
<b>Signal Filter</b>	HRT-370	HART Signal Filter with one AI and one HART channel

NEW

## Ethernet to HART Converter

### I-7547



The I-7547 is an Ethernet to HART converter designed as the master device of HART protocol. It allows users to access the HART slave via Ethernet. These HART slave devices may be a transmitter, actuator, current output device and so forth. In addition, by using the HC\_Tool utility, users can configure module and test HART communication easily and quickly.

- Support HART Burst mode
- Allow two HART masters
- Provide four HART channels

- Selectable 250 Ω load resistor
- Support HART Short/Long frame
- Support point-to-point or multi-drop HART mode
- Support connecting up to 15 HART slave devices
- Support firmware update via Ethernet
- Support HART Pair-Connection (FW\_v1.03)
- Support FDT (Field Device Tool) technology



## USB to HART Converter

### I-7567



I-7567 is a USB to HART converter specially designed as the master device of HART protocol. Through it, users can easily access the HART network via USB port which is implemented as a virtual COM port on PCs or notebooks. Because the I-7567 is powered by the USB interface, the external power is not necessary. Moreover, the I-7567 provides the Utility tool which is helpful for diagnosing and configuring the HART network.

- Support HART Short/Long frame
- Support HART Burst mode
- Allow two HART masters
- Support the in point-to-point or multi-drop HART network mode

- Powered by USB (external power is not necessary)
- Support firmware update via USB
- Provide selectable 250 Ω load resistor
- Allow to connect with Max. 15 HART modules
- Compatible with USB 1.1 and 2.0 standards
- Support HART OPC Server provided by HART COMMUNICATION FOUNDATION (HCF)



## RS-232/422/485 to HART Converter

### I-7570



The I-7570 is a Serial to HART converter specially designed as the master device of HART protocol. By using I-7570, the HART devices, such transmitters, actuators, gauges, meters, and the current output devices, can be easily integrated into the HMI/PLC/PC devices via serial port which may be RS-232/RS-422/RS-485 interface. In order to diagnose and configure the HART network more easily, the I-7570 Utility tool with friendly configuration interface is given. It is helpful for diagnosing and configuring the HART network.

- Support HART Short/Long frame
- Support HART Burst mode
- Allow two HART masters
- Support the in point-to-point or multi-drop HART network mode

- Support firmware update via COM1
- Allow to connect with Max. 15 HART modules
- Provide selectable 250 Ω load resistor
- Isolated COM 1: 3-wire RS-232/RS-422/RS-485
- Support HART OPC Server provided by HART COMMUNICATION FOUNDATION (HCF)



### HART to Single Mode Fiber Converter

#### HRT-227CS



The HRT-227CS is a HART to Fiber converter paired used to extend HART communication distance via single mode fiber optic transmission medium. In order to solve the problem between HART and fiber transmission medium, HRT-227CS is specially designed for converting the HART signal to fiber optic cables. Built-in a HART 250 Ω loop resistor adjustable by dip switch. Therefore, users can make data collection and processing of HART network easier and quicker by applying HRT-227CS. In addition, we also provide the free HC\_Tool utility for module configuration easily.

- Support HART Burst mode
- Allow two HART masters
- Fiber broken line detection
- Support HART Short/Long frame
- Support firmware update via COM port
- Support point-to-point or multi-drop HART mode
- Support connecting up to 15 HART slave devices
- Fiber Type: SC ; Single mode ; 100 Base-FX
- Fiber max. transmission distance up to 30 km
- Selectable 250Ω loop resistor
- The HART port with the same Group ID can communicate with each other

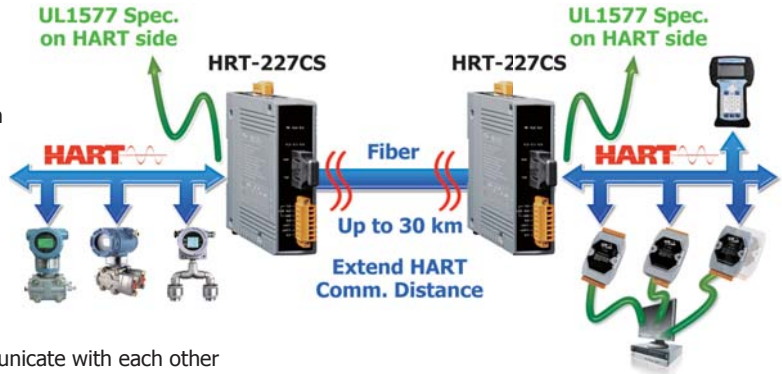

### HART-to-Analog Converter and Loop Monitor

#### HRT-328-A4



The ICPDAS HRT-328-A4 HART Loop Converter enables the conversion of a digital multivariable HART signal into four independent 4 ~ 20 mA analog process variables. The HRT-328-A4 can apply in control or monitoring application to obtain up to four additional analog outputs without additional process penetrations.

The HRT-328-A4 allows up to four additional analog process variables from a multivariable transmitter or valve with no additional process penetrations. Besides, installed transparently across the 4~20 mA instrument loop, the HRT-328-A4 reads the HART digital process data that rides on the loop wires. The HRT-328-A4 converts the digital information for up to four isolated analog process signals that are readily accepted by in-place control system, such as DCS or PLC. The HRT-328-A4 not

only converts multivariable into analog process signal but also monitors the multivariable under/over limit intelligently. There are 4 built-in user programmable alarm output for monitoring. When a variable of transmitter under or over the user defined limit, the programmable alarm will activate automatically without DCS or PLC.

- Support HART Short/Long frame
- 4 Independent Analog Output Signals
- Built-in 2 Form A and 2 Form C relays
- Intelligent Activate Relay Alarm automatically
- Support Acquire Long Frame Address Automatically
- Working in Point-to-Point Mode
- Support HART Burst mode
- Allow two HART Masters
- Support Firmware Update

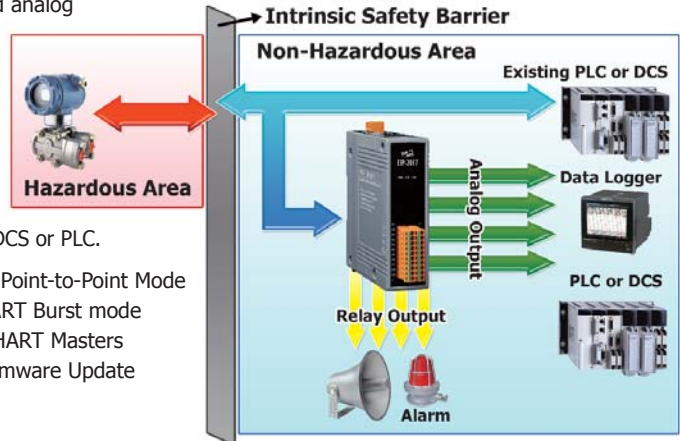

### Modbus RTU/ASCII Slave to HART Master Gateway

#### HRT-710



#### HRT-310



The HRT-710/HRT-310 is a Modbus RTU/ASCII slave to HART master gateway. It provides an economic solution for Modbus master device to access the HART slave devices. In order to diagnose and configure the HART network more easily, the HG\_Tool Utility with friendly configuration interface is given.

- Support HART Short/Long frame
- Isolated COM 1: RS-232/422/485
- Connecting up to 15 HART modules
- Support Modbus RTU and ASCII format
- Working in point-to-point or multi-drop HART mode
- Support firmware update via Com Port (FW\_v1.2 and HW\_v1.2)
- Support on-line replacement of HART devices (FW\_v1.5)
- Support acquire Long Frame Address automatically (FW\_v1.5)
- Support HART Burst mode
- Support Modbus Slave mode
- Allow two HART Masters

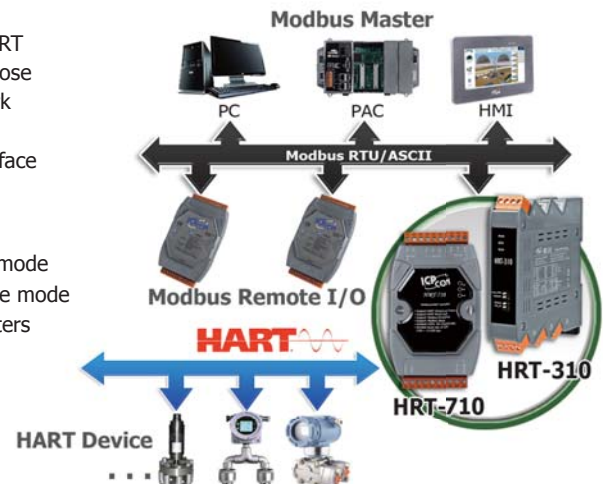



NEW

## Modbus TCP Slave to HART Master Gateway

### HRT-711



The HRT-711 is a new Modbus/TCP to HART Gateway. It allows the Modbus/TCP Master to access the HART Slave devices. These HART devices may be a transmitter, an actuator, a current output device and so forth. By using the HRT-711, users can integrate their HART devices into Modbus network easily. Therefore, HRT-711 can be a powerful gateway to exchange the data between Modbus and HART network. Moreover, the HRT-711 can be applied in the various hard environments because its high isolation protection designs. This design makes users to apply widely application for the remote data acquisition, control, process automation, and factory automation, etc.

- Support HART Short/Long frame
- Support HART Burst mode
- Allow two HART Masters
- Working in point-to-point or multi-drop HART mode
- Connecting up to 15 HART modules
- Support Modbus TCP
- Support Modbus Slave mode
- Support firmware update via Com Port
- Support on-line replacement of HART devices
- Support acquire Long Frame Address automatically

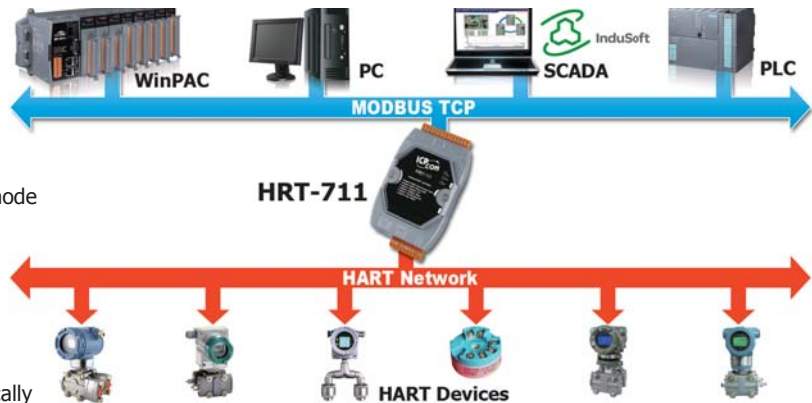

## PROFIBUS DP Slave to HART Master Gateway

### GW-7557



The GW-7557 is designed for the slave device of PROFIBUS DP protocol. It allows the PROFIBUS master to access the HART slave devices. These HART devices may be a transmitter, an actuator, a current output device and so forth. Owing to the GW-7557, you can put the HART slave devices into PROFIBUS network very easily.

- Support PROFIBUS DP-V0 slave
- Support 4 HART Channels
- Support HART Short/Long frame
- Support HART Burst mode
- Allow two HART Masters
- Protocol & Hierarchy: DP-V0 Slave
- Max I/O Data Length: 240/240 Bytes
- Working in point-to-point or multi-drop HART mode
- Connecting up to 15 HART modules
- Network Isolation Protection: High Speed iCoupler
- Detect transmission rate (9.6 ~ 12000 kbps) automatically
- Max transmission speed up to 12 Mbps for PROFIBUS and 115.2 kbps for COM Port

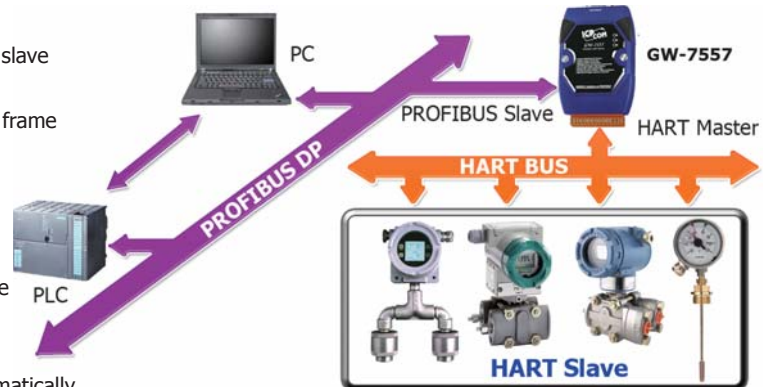

Available soon

## HART Signal Filter

### HRT-370



HRT-370 can receive a 4 to 20 mA DC current signal from HART device or control system analog output and passes the signal bi-directionally and uninterruptedly. Besides, HRT-370 also provides a HART interface to communicate with HART device. By using HRT-370, it can effectively isolate the HART device communication signal from control system analog signal.

- Support HART Burst mode
- Allow two HART masters
- Support HART Short/Long frame
- Support 4 ~ 20 mA current input
- 2-wire or 4-wire transmitters of HART
- Allow to connect to the Max. 15 HART modules
- Support the in point-to-point or multi-drop HART network

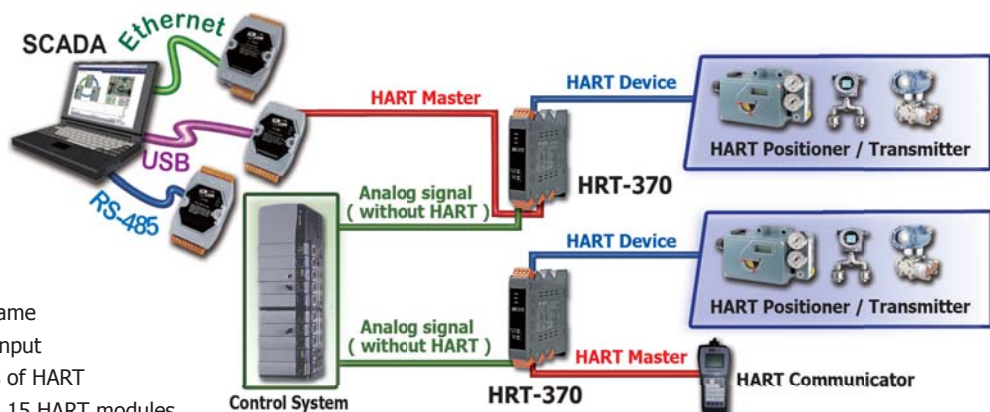

## 6.18 M-Bus Converters & Gateways

Model Name	Description	
M-Bus Repeater	I-3591	M-Bus Repeater
M-Bus converter	I-7590	RS-232/422/485 to M-Bus converter
M-Bus gateway	GW-7828	Modbus RTU slave to M-Bus master gateway
	GW-7838	Modbus TCP server to M-Bus master gateway

Available soon

### M-Bus Repeater

#### I-3591



The I-3591 is a M-bus repeater which could be a component of the M-bus system. It is designed for use in plants where extensive bus lines are required, or where large numbers of meters need to be connected, for example in district heat networks that supply heat to entire sections of towns.

- M-Bus to M-Bus Repeater
- Supports M-Bus slaves: 100
- Overcurrent detection
- Duplicate node id detection
- M-Bus Baud rate: Automatic baud rate detection
- M-Bus Data Format: Automatic data format detection

NEW

### RS-232/422/485 to M-Bus converter

#### I-7590



The I-7590 is specially designed for M-Bus slave device. It offers RS-232, RS-422 and RS-485 three kinds of communication way. For the hardware of the I-7590, it has two rotary switches for serial port and M-Bus port baud rate. This design allows master baud rate to be different from the M-Bus slave baud rate. For the communication of the I-7590, it uses transparent communication. It solves the problem when performing protocol conversion between the master and the slave, and makes the communication easier. I-7590 is perfect for use when a new M-Bus device is added to an old RS-485 network or when the master firmware and configuration required not being changed.

- M-Bus Baud rate : Adjustable by rotary switch from 300 to 2400 bps
- Serial Baud rate : Adjustable by rotary switch from 300 to 115200 bps
- Default serial port data format: Data bit 8, Parity none, Stop bit 1
- Overcurrent and short-circuit protection on the M-Bus
- Update firmware from serial port
- Support up to 100 M-Bus slaves
- Provides transparent communication

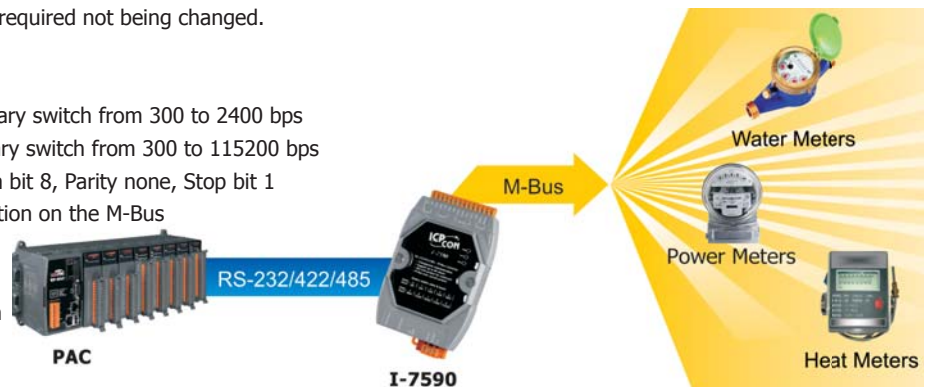

### Modbus RTU/TCP to M-Bus Gateway

#### GW-7828



The GW-7828/GW-7838 gateway is a Modbus slave device that allows the Modbus RTU/Modbus TCP master to access the M-Bus slave devices. These M-Bus devices may be a water meter, electric meter, power meter and so forth. Owing to the GW-7828/GW-7838, you can put the M-Bus slave devices into Modbus network very easily.

- Support command request mode and cyclic request mode
- Modbus RTU baud rate: Support from 300 to 115200 bps
- Overcurrent and short-circuit protection on the M-Bus
- M-Bus baud rate : Support from 300 to 2400 bps
- Support up to 100 M-Bus slaves

#### GW-7838

Available soon



# Wireless Solution

# 6

1 **WLAN Products** P 6-1

2 **Radio Modems** P 6-10

3 **3G/4G Products** P 6-11

- 3.1 SMS Remote Module - - - - - P 6-11
- 3.2 3G/4G Modem - - - - - P 6-12
- 3.3 Mini PAC with 3G/4G Communication- - - - - P 6-12
- 3.4 M2M RTU Module - - - - - P 6-13

4 **GPS Products** P 6-14

5 **Bluetooth LE Converters** P 6-14

6 **ZigBee Products** P 6-15

7 **Infrared Wireless Modules** P 6-18

- Universal IR Learning Remote Module- - - - - P 6-19
- IR Controlled Power Relay Module - - - - - P 6-20

8 **Wireless Modbus Data Concentrators** P 6-21

- Wi-Fi Modbus Data Concentrator / ZigBee Modbus Data Concentrator - - - - P 6-21





# 1. WLAN Products

Nowadays, Wireless LAN applications are very popular. They're not only faster than traditional industrial transmissions, i.e. RS-232, RS-485, RS-422 etc, but are also able to minimize the need for troublesome wiring tasks and have a higher mobility than an Ethernet network.



Classified Index		Model Name
WLAN Remote Maintenance Device		M2M-711D
CAN to Wi-Fi Converter		I-7540D-WF
Ethernet to Wi-Fi Bridge		WF-2571
WLAN Gateway		RMV-760D-MTCP
Wi-Fi Access Point		APW77BAM
Ethernet/UART to Wi-Fi Converter		IOP760AM
Ethernet/UART/Wi-Fi to 4G LTE Converter		IOG761AM, IOG851
Wi-Fi I/O Modules	Thermocouple, Voltage & Current Input Module	WF-2017, WF-2019
	RTD Input Module	WF-2015
	Digital I/O Module	WF-2042, WF-2051, WF-2055
	Relay Output & Digital Input Module	WF-2060, WFM-R14
	Multifunction I/O Module	WF-2026

## ▼ WLAN Remote Maintenance Device



M2M-711D

### Features:

- Supports static IP/DHCP (Ad Hoc mode don't support DHCP)
- Ethernet Protocol: TCP, UDP, IP, ICMP, ARP,RARP
- Provide dynamic DNS function
- Support IEEE 802.11 b/g for Wi-Fi mode and Ad Hoc mode
- Support WEP-64,WEP-128, WPA-TKIP and WPA2-AES encryption for Wi-Fi mode
- Support WEP-64,WEP-128 encryption for Ad Hoc mode
- Provides 1~13 RF channels
- Auto control channel in AP mode
- Ad Hoc mode transmission range up to 100 m (Line of sight)
- Accommodate with M-4132, M2M-720A, M2M-710D
- Web-based administration

### Introduction:

The M2M-711D module is specially designed for the remote maintenance and upgrading the serial to network application solution. Users can choose Ethernet mode or Wi-Fi mode to do the pair connection, which provides TCP data tunneling between two serial devices.

In addition to M2M-710D original features, it has the Ad Hoc mode of operation. This operation mode can be used to extend the distance of RS232/485 network without Wi-Fi AP and Ethernet Hub.

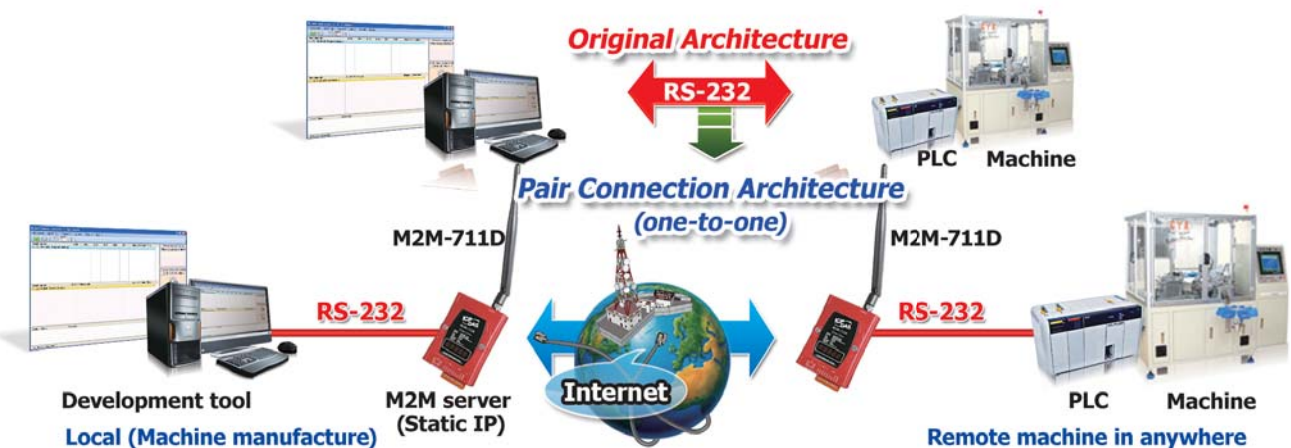

## ▼ CAN to Wi-Fi Converter



### I-7540D-WF

### Features:

- IEEE 802.11b/g compliant
- Wireless data transmission via WLAN
- Two different operation modes: infrastructure and ad-hoc
- Point to point or point to multi-points connection via WLAN
- Support WEP, WPA and WPA2 encryption for WLAN
- CAN 2.0A/2.0B compliant
- Connect CAN networks via a WLAN bridge
- Communication efficiency:  
one-way is up to 700 fps (client->server, server->client),  
two-way 350 fps (client<=>server)
- Wireless communication: 100 m (Without PA) / 300 m (With PA)

### Introduction:

I-7540D-WF supports the wireless transmission of CAN data between various CAN networks or a CAN network and a WLAN network according to the 802.11b/g standard. I-7540D-WF is highly suitable for connecting mobile (e.g., vehicles or machines) or stationary CAN networks and often used for short ranges up to 100 or 300 m. (TCP data protocols are available.) Using an appropriately configured router, CAN data can be transmitted over the Internet. There are two operating modes in the I-7540D-WF: access point mode and ad-hoc mode. In the access point mode, the data connection takes place over one or several WLAN access points that are often part of the company's internal IT infrastructure. In the ad-hoc mode, a direct connection is established between a single I-7540D-WF device and a PC (with an integrated WLAN interface), or with a second I-7540D-WF device. In this way, the I-7540D-WF can be used as a CAN diagnosis interface. The wireless connection that established between two I-7540D-WF can be used instead of a cable, and enables the connection of CAN networks.



## ▼ WLAN Gateway



### RMV-760D-MTCP

Modbus TCP/RTU Data-Exchange  
with Wi-Fi Interface Gateway

### Features:

- Supports pair-connection applications
- Application Modes: Virtual COM, MB TCP Server/Client, MB RTU Master/Slave
- Supports static IP/DHCP (Ad Hoc mode don't support DHCP)
- Ethernet Protocol: TCP, UDP, IP, ICMP, ARP, RARP
- Support IEEE 802.11 b/g for Wi-Fi mode and Ad Hoc mode
- Support WEP-64, WEP-128, WPA-TKIP and WPA2-AES encryption for Wi-Fi mode
- Support WEP-64, WEP-128 encryption for Ad Hoc mode
- Auto control channel in AP mode

### Introduction:

RMV-760D-MTCP is a Modbus TCP/RTU gateway. It exchanges Modbus command from Modbus TCP/RTU master to Modbus RTU/TCP slave. Modbus TCP command can be transceived not only Ethernet port but also Wi-Fi interface. It supports VxComm and Pair-Connection functions. Users can choose Ethernet mode or Wi-Fi mode to implement the pair connection, which provides TCP data tunneling between two serial devices.

### Pair-Connection

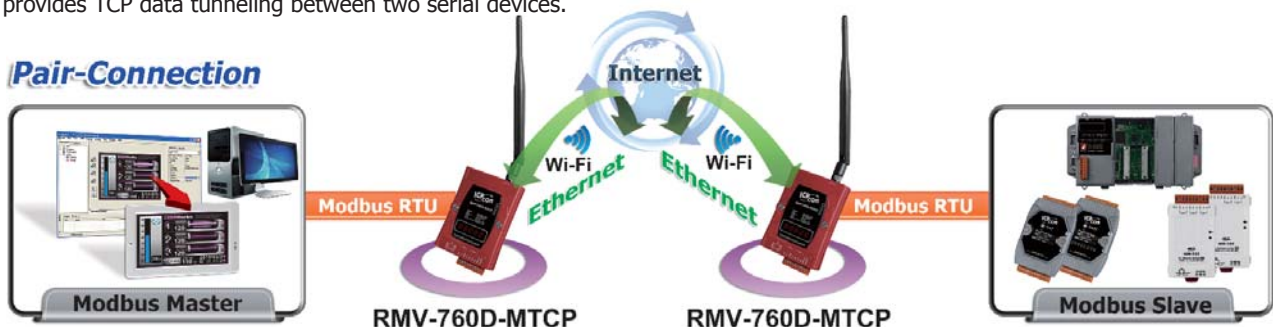

## ▼ Wi-Fi I/O Modules

The WF-2000(Wi-Fi) wireless products are the Wi-Fi I/O modules. The WF-2000 series in WLAN connection comply with the IEEE802.11b/g standards. With the popularity of 802.11 network infrastructure, the WF-2000 series make an easy way to incorporate wireless connectivity into monitoring and control systems. The WF-2000 series also support Modbus/TCP and UDP protocol and the network encryption configuration, which make perfect integration to SCADA software and offer easy and safe access for users from anytime and anywhere.

### ✓ RTD, Thermocouple, Voltage & Current Input Module

Model Name	AI		
	Channel	Voltage and Current Input	Sensor Input
WF-2015	6	-	RTD: Pt100, Pt1000, Ni120, Cu100, Cu1000
WF-2017	8/16 (DIFF/SE)	±150 mV, ±500 mV, ±1 V, ±5 V, ±10 V, 0 ~ +20 mA, +4 ~ +20 mA, ±20 mA	-
WF-2019	10	±15 mV, ±50 mV, ±100 mV, ±500 mV, ±1 V, ±2.5 V, ±5 V, ±10 V, ±20 mA	Thermocouple: J, K, T, E, R, S, B, N, C

### ✓ Digital I/O Module

Model Name	DI/Counter			DO			
	Channel	Contact	Sink/Source	Channel	Type	Sink/Source	Max. Load Current @ 25°C
WF-2042	-	-	-	16	Open Collector	Sink	700 mA/channel
WF-2051	16	Dry, Wet	Dry: Source Wet: Sink/Source	-	-	-	-
WF-2055	8	Dry, Wet	Dry: Source Wet: Sink/Source	8	Open Collector	Sink	700 mA/channel

### ✓ Relay Output & Digital Input Module

Model Name	DI/Counter			Relay Output		
	Channel	Contact	Sink/Source	Channel	Relay (Type)	Max. Load Current @ 25°C
WF-2060	6	Dry, Wet	Dry: Source Wet: Sink/Source	6	Power Relay (Form A)	5.0 A/channel
WFM-R14	-	-	-	14	2 Power Relays (Form A) 12 Power Relays (Form C)	5.0 A/channel (Form A) 6.0 A/channel (Form C)

### ✓ Multifunction Module

Model Name	AI		AO		DI/Counter		DO	
	Channel	Voltage and Current Input	Channel	Voltage and Current Output	Channel	Contact	Channel	Type
WF-2026	5	±150 mV, ±500 mV, ±1 V, ±5 V, ±10 V, 0 ~ 20 mA, 4 ~ 20 mA, ±20 mA	2	0 ~ 5 V, 0 ~ 10 V, ±5 V, ±10 V, 0 ~ 20 mA, 4 ~ 20 mA	2	Dry (Source)	3	Open Collector (Sink)

## Application architecture:

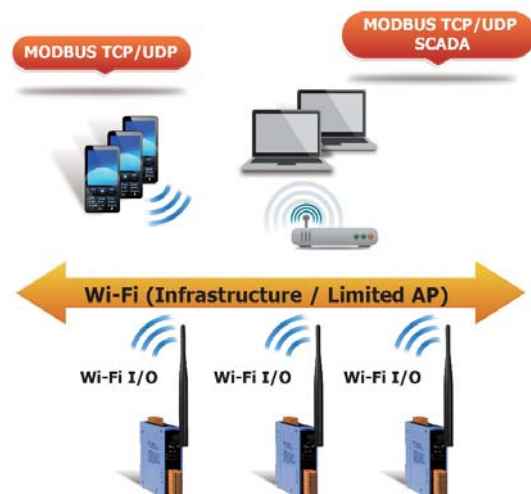

## Multi-platform Remote Access Software:

Real-time data from the WF-2000 I/O module can be accessed from anywhere and at any time using the WF IO Utility and iOS App



### Download:

1. Download by iTunes App Store  
Search keyword: WF2000

### Compatibility:

Requires iOS 8.1 or later.  
Compatible with iPhone, iPad, and iPod touch



## ▼ Wi-Fi Access Point



**APW77BAM**

### Features:

- Thin AP
- Wall-Mount Wi-Fi Access Point
- IEEE 802.11a/b/g/n/ac Wi-Fi Compliance
- Configurable AP Transmit Power and Channel
- Supports WEP, WPA, WPA2, WPA-PSK, WPA2-PSK and 802.1x
- Segmented guest and corporate access with multiple SSIDs
- One IEEE 802.3 af (PoE), or DC12V/1A
- Roaming
- WDS/Repeater/Client Modes
- Point-to-Point and Point-to-Multipoint Bridging
- AP Load Balance
- Website Configuration Interface

### Introduction:

The APW77BAM is designed for medium-sized businesses to extend the existing networks and has the ability to operate in different modes and can be used in a wide variety of wireless applications. Its Universal Repeater Mode not only has an easier way for setup, but also provides better performance and compatibility to create a larger wireless network infrastructure by linking up other access points. It also supports Multiple-SSID function to simultaneously emulate 8 APs with different ESSIDs and separate packets via VLAN IDs.

### Connection Diagram:

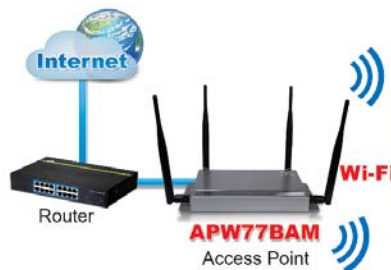

#### Application Fields



### Applications:

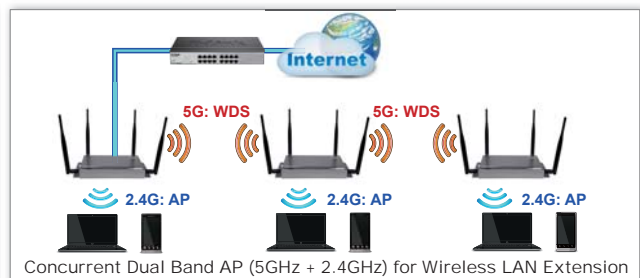
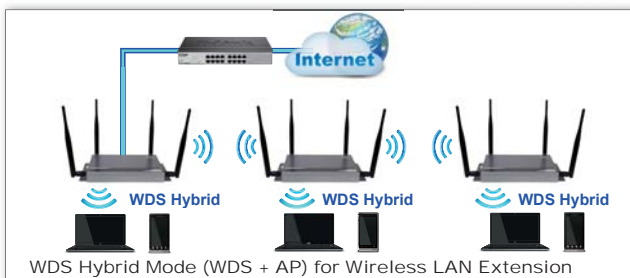
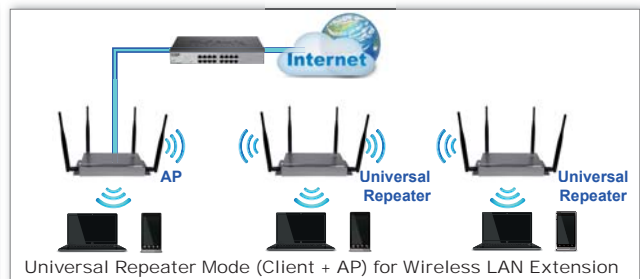
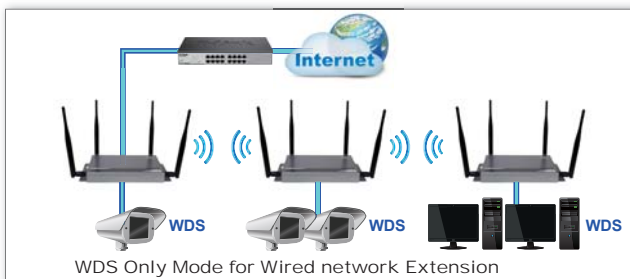
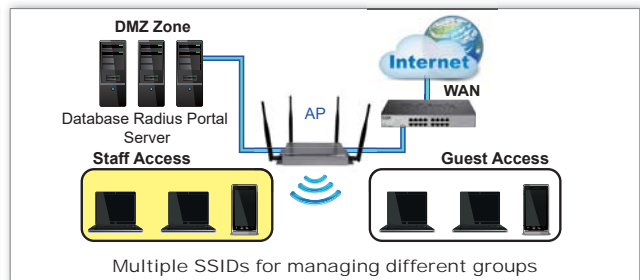
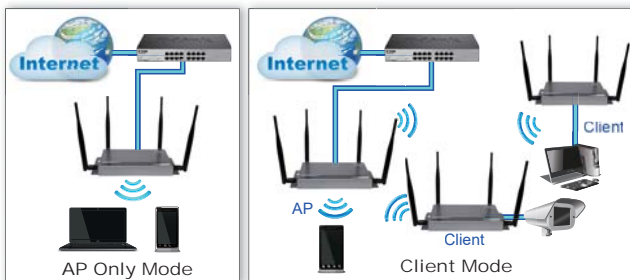

## ▼ Ethernet / UART to Wi-Fi Converter



**IOP760AM**

### Features:

- Wi-Fi Uplink or Ethernet WAN Connection
- One RS-232/485 for Modbus RTU Connection
- IEEE 802.11a/b/g/n/ac Wi-Fi Compliance
- One LAN Port for Linking Local Ethernet Devices
- One DI/One DO For Device Triggering or Event Reporting
- Designed by Solid And Easy to Mount Metal Body
- Wi-Fi/Ethernet/UART Bridge
- Roaming
- Command Line Interface (CLI)
- Website Configuration Interface
- Modbus Connections
- Router Mode

### Introduction:

The IOP760AM is absolutely the right choice for wireless M2M (Machine-to-Machine) applications. With built-in high performance IEEE802.11a/b/g/n/ac compliant Wi-Fi uplink or multi-mode access point function, you can connect all your devices wirelessly while the wired deploying is too difficult or not feasible. Besides, with VPN tunneling technology, remote sites easily become a part of Intranet, and all data are transmitted in a secure (256-bit AES encryption) link. IOP760AM is loaded with luxuriant security features including VPN, firewall, NAT, port forwarding, DHCP server and many other powerful features for complex and demanding business and M2M applications. The redundancy design in fallback 9 ~ 48 VDC power terminal and VRRP function makes the device as a back-up in power, network connection and data transmission without lost.

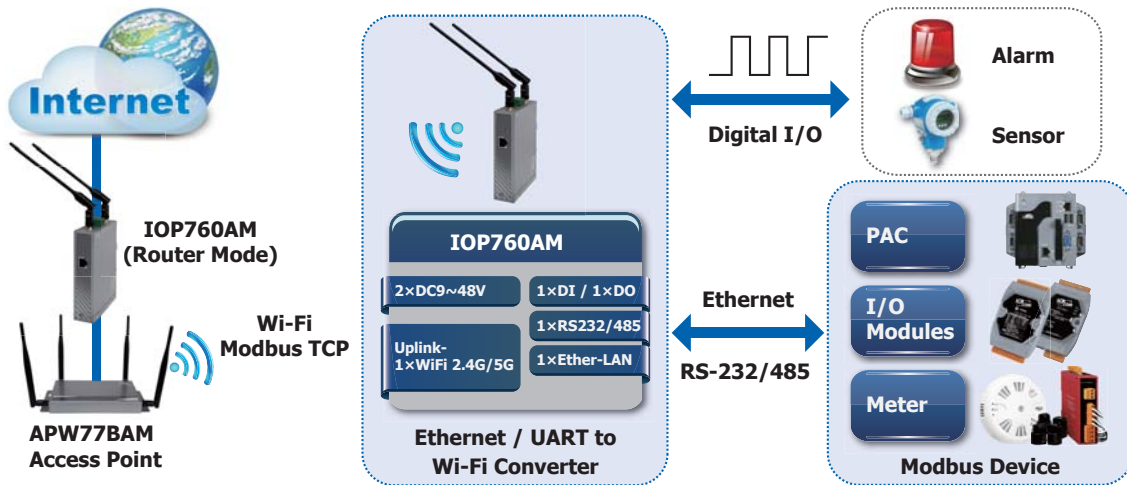

### Applications:

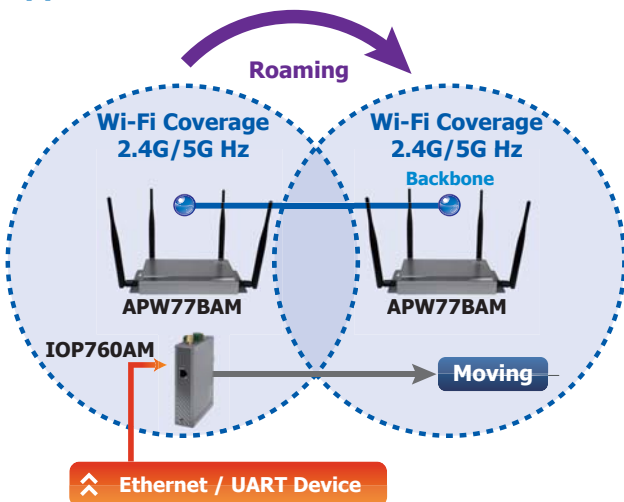

### Function:

- To deploy an Ethernet/UART to Wi-Fi Converter for industrial automation.

### Description:

- The easiest way to deploy an Ethernet/UART to Wi-Fi Converter for connecting your industrial automation or telemetry equipments to the local / remote management center with wireless solution.
- With 802.11n/ac (2.4G/5GHz selectable) as connection interface, it is simple to connect with existing wireless local data network.
- The most cost-effective product for you with robust design for secure internet access, variable voltage range, wide temperature range.
- Wi-Fi Roaming applications with APW77BAM

## ▼ Ethernet / UART / Wi-Fi to 4G LTE Converter



### Features:

- 1 × embedded LTE module with dual-SIM failover for reliable and efficient access.
- 3(4) × FE LAN port with tag based and port based VLANs easily to group control and relocate traffic pattern.
- Wi-Fi standard
  - IOG761AM supports IEEE 802.11 n 2T2R (2.4G Hz)
  - IOG851 supports IEEE 802.11n/ac 2T2R (2.4G/5G Hz selectable)
- 1 × DB9 (RS232/RS485) interface for Modbus RTU/ASCII and various serial communication protocol, and 1 × DI, 1 × DO for device triggering or event reporting.

### Introduction:

The IOG761AM and IOG851 are loaded with powerful features for complex and demanding business and M2M (Machine to Machine) applications. The redundancy design in fallback 9 - 48 VDC power terminal, dual SIM cards and VRRP function makes the device as a back-up in power, network connection and data transmission without lost.

### Applications:

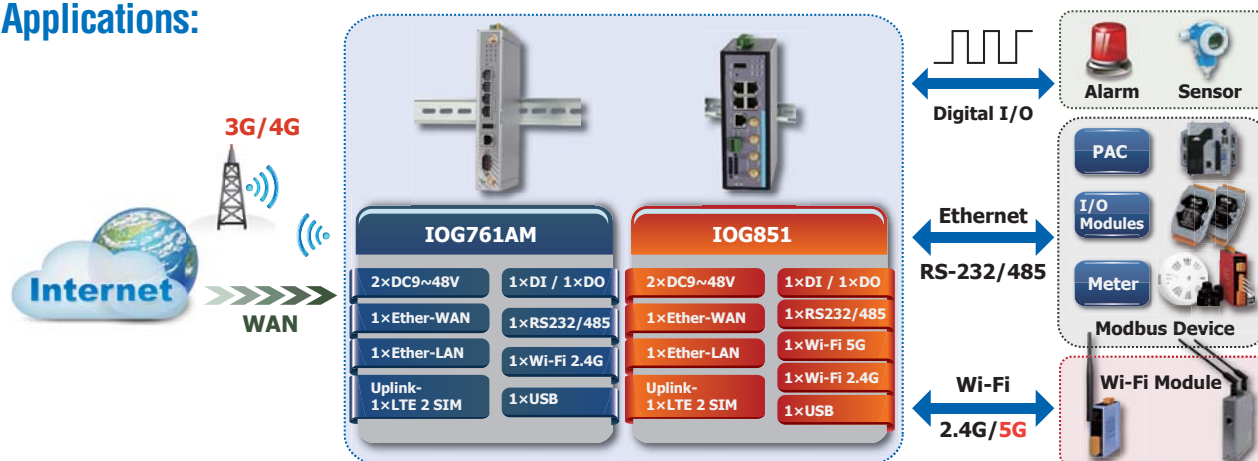

Device	IOG761AM	IOG851
Model Name	IOG761AM	IOG851
Pictures		
<b>Device Interface</b>		
Uplink	1 × LTE module (dual SIM), 1 × RJ45 FE (configurable)	
Ethernet	3(4) × RJ45 FE	
Wi-Fi	IEEE802.11n 2T2R (2.4G Hz)	IEEE802.11n/ac 2T2R (2.4G/5G Hz selectable)
Communication Bus	1 × DB9 RS232/RS485	
I/O	1 × DI ("Logic 0": 0 ~ 2V, "Logic 1": 5V ~ 30V), 1 × DO (Relay Mode, up to 30V / 1A)	
Management Port	1 × RJ12 RS232 (Console)	
Log Storage	1 × USB 2.0	
Cellular Band	LTE: 800/900/1800/2100/2300/2600 MHz, UMTS: 850/900/1900/2100 MHz, GPRS/EDGE: 850/900/1800/1900 MHz	
Antenna	2 × 5dBi detachable ant. (Wi-Fi), 2 × 3dBi detachable ant. (3G/4G)	
Power Source	Dual DC 9V ~ 48V	



## ▼ Wi-Fi solution for AGV system

The AGV (Automated Guided Vehicle) system is more and more popular in the warehouse management. People can control their AGV system via the wireless interface. Wi-Fi is the proper media for the AGV application. It provides the large bandwidth transmission for the film of the camera. It is also expandable. If you want to extend your communication distance, you can add more Wi-Fi devices for the larger coverage.

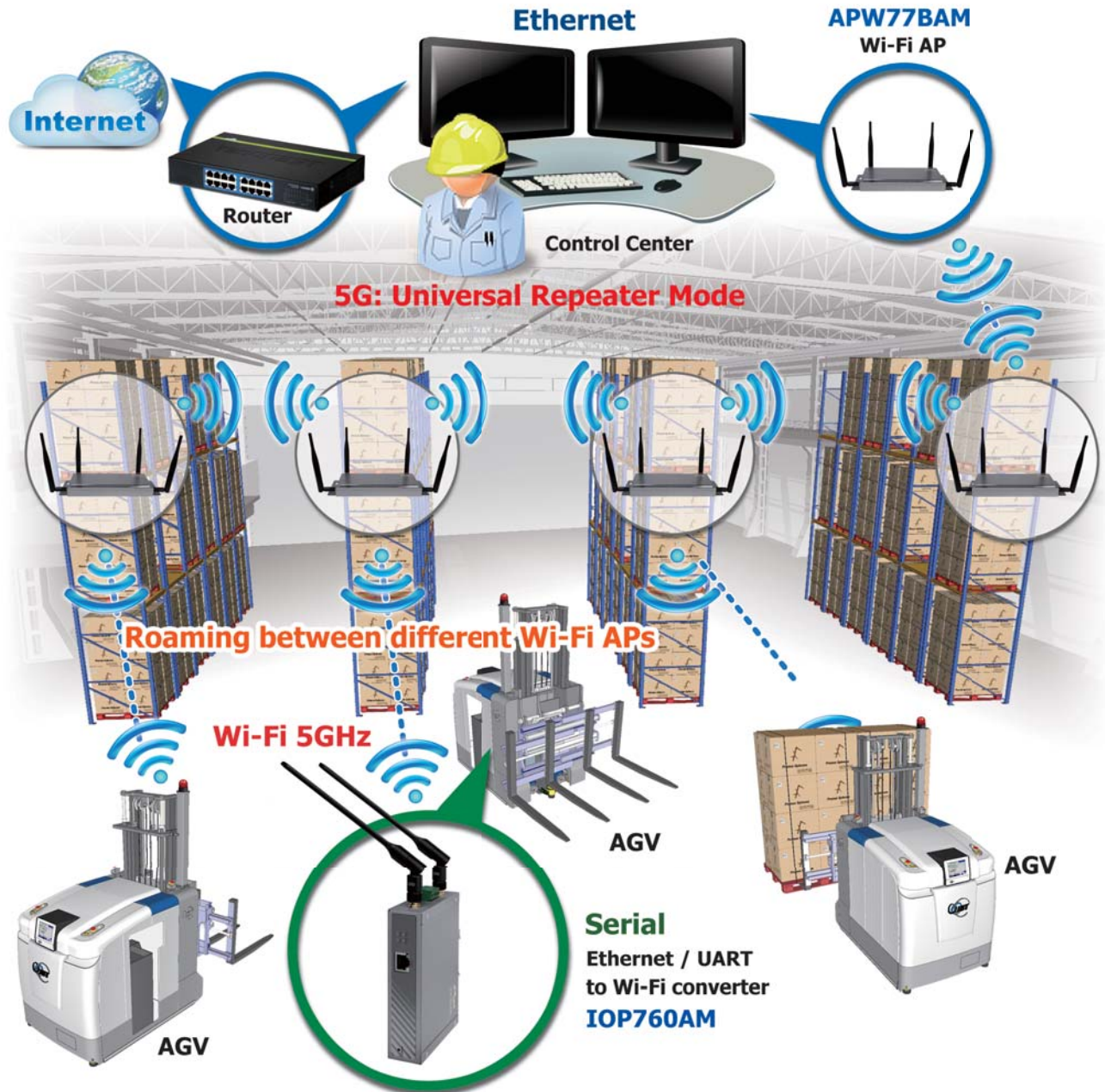

ICPDAS provides a better Wi-Fi solution for the AGV system. IOP760AM and APW77BAM support IEEE 802.11 ac (5GHz) and Wi-Fi roaming. IEEE 802.11 ac works in the 5GHz band, and it does not be influenced by 2.4GHz (802.11 b/g/n) or another ISM band devices. Wi-Fi roaming can make the communication stable between APs (APW77BAM). APW77BAM is a thin AP. It is convenient for monitoring and extending the Wi-Fi coverage range. The Wi-Fi converter IOP760AM provides one RS-232 and one Ethernet interface. The AGV can work via different interface. That is adaptable and convenient for AGV application.

Model	Description
APW77BAM CR	Wi-Fi Access Point (with category A plug type)
APW77BAM-EU CR	Wi-Fi Access Point (with category E plug type)
IOP760AM CR	Ethernet/UART to Wi-Fi Converter (with category A plug type)
IOP760AM-EU CR	Ethernet/UART to Wi-Fi Converter (with category E plug type)

## ▼ IOP760AM Application Mode

The IOP760AM is a powerful wireless M2M (Machine-to-Machine) solution. Users can connect all your devices wirelessly while the wire deploying is too difficult or not feasible. There are 4 popular application modes: Modbus Router, Fieldbus Bridge, Point-to-Point and Roaming Threshold.

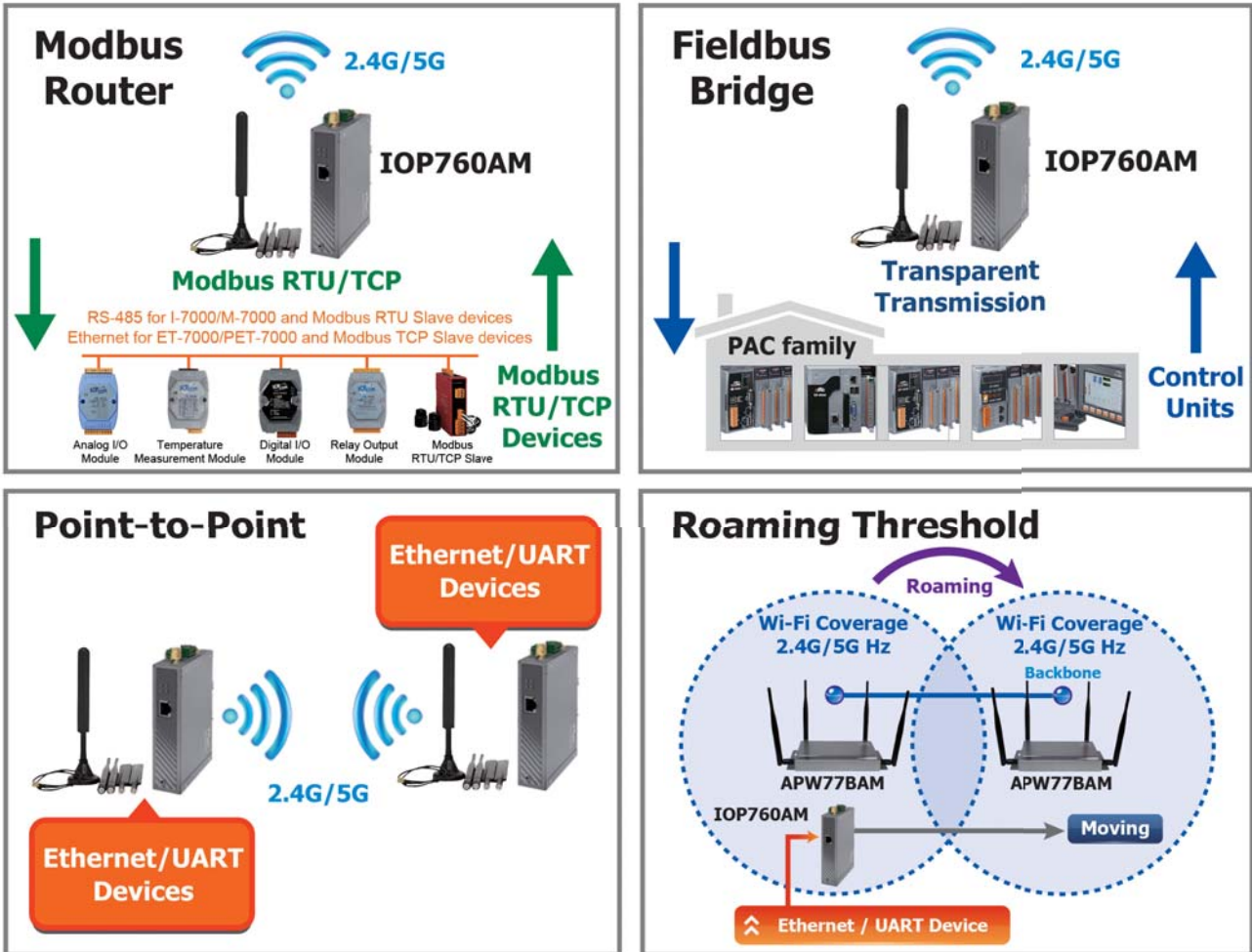

### (1) Modbus Router

The IOP760AM is a Modbus master or slave. All the Modbus RTU and TCP/IP devices can publish their data to Wi-Fi via IOP760AM.

### (2) Fieldbus Bridge

In the SCADA system, the vendor-defined command is common to control units. The transparent transmission is required when these control units make connection with Wi-Fi.

### (3) Point-to-Point

In the out-door application, users are hard to construct the Ethernet environment. All the devices can establish the wireless connection via IOP760AM conveniently.

### (4) Roaming Threshold

The vehicle solution is more and more popular. "How to build a stable wireless environment" is an important issue. ICPDAS provides a Wi-Fi solution for the roaming system: IOP760AM and APW77BAM. The APW77BAM is a Wi-Fi AP (access point) with built-in roaming function. Users can set the Wi-Fi signal strength threshold in the IOP760AM. If the Wi-Fi signal strength is lower than the threshold, the IOP760AM can connect to another APW77BAM automatically.

## ▼ Wi-Fi Converter Comparison

In the factory solution, WF-2571, IOP760AM and IOG761AM provide a complete solution for the wireless coverage.

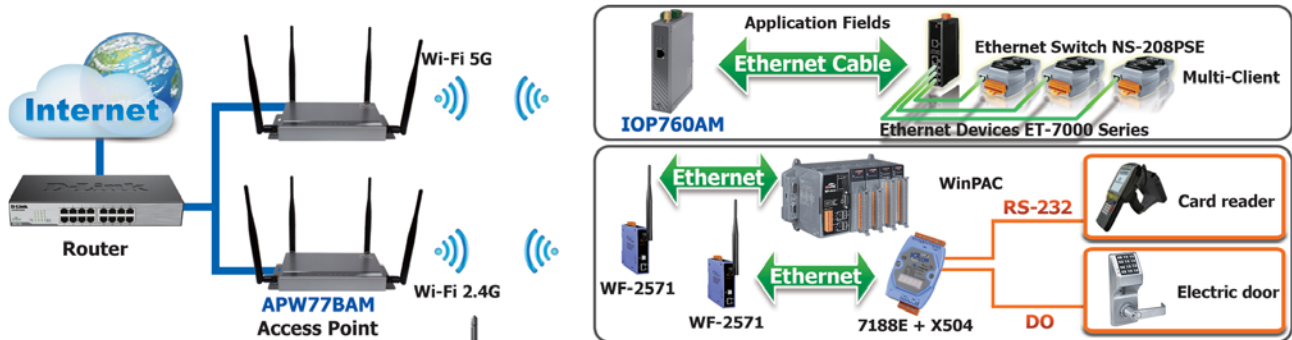

Model Name		WF-2571	IOP760AM	IOG761AM	IOG851
Pictures					
Wireless Standards		IEEE 802.11 b/g	IEEE 802.11 b/g/n/ac	IEEE 802.11 b/g/n	IEEE 802.11 b/g/n/ac
Bandwidth		2.4GHz	2.4G/5GHz	2.4G	2.4G/ 5G Hz
Cellular		-	-	LTE: 800/900/1800/2100/2600 MHz, UMTS: 850/900/1900/2100 MHz, GPRS/EDGE: 850/900/1800/1900 MHz	
Antenna		1	2	4 (2 × Wi-Fi, 2 × 3G/LTE)	
Modbus Protocol		-	-	Yes	
Interface		Wi-Fi	Yes		
		Ethernet	Yes		
		UART	-	RS-232	
		3/4G LTE	-	Yes	
Bridge Mode		Wi-Fi/Ethernet	Yes		
		Wi-Fi/UART	-	Yes	
		Ethernet/UART	-	Yes	
		LTE/Ethernet	-	Yes	
		LTE/Wi-Fi	-	Yes	
		LTE/UART	-	Yes	
		Multi-Client	-	Yes	
Configuration Interface		Utility	Web Server		

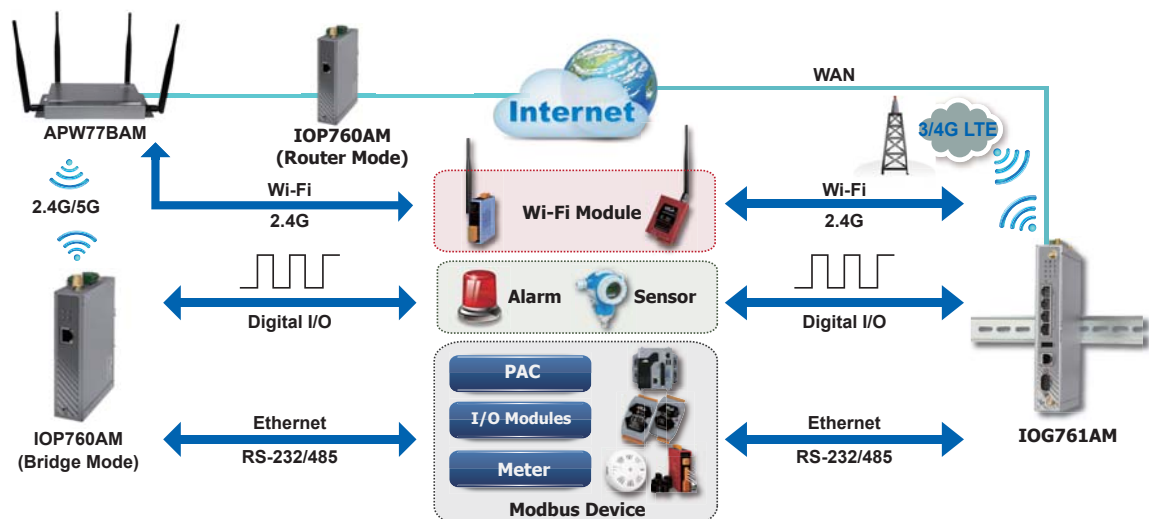





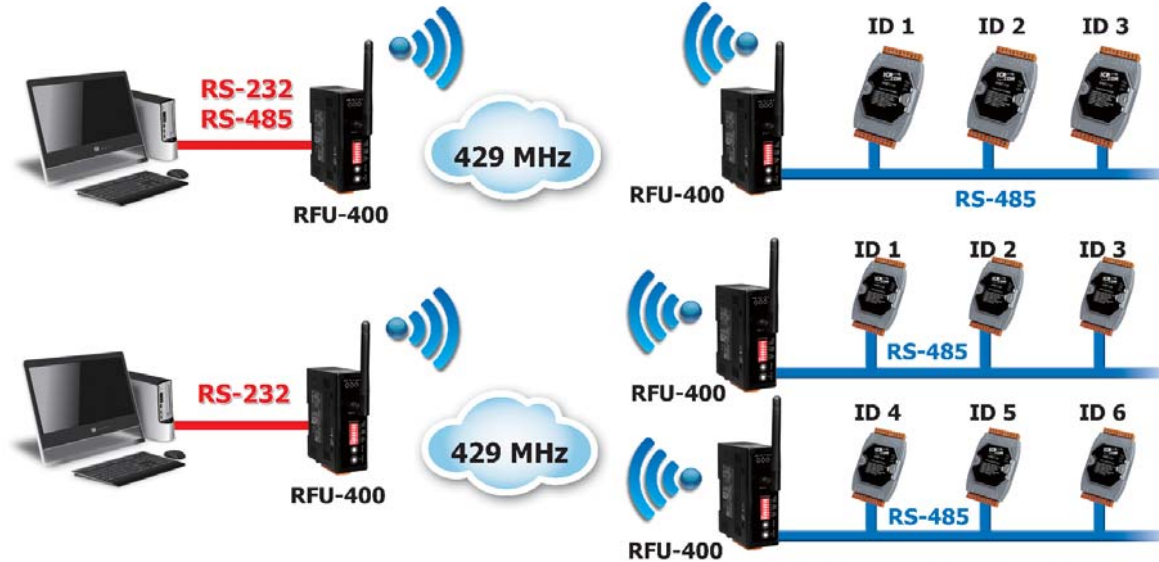

## 2. Radio Modem

ICP DAS provides RFU and SST series wireless modem which is designed for data acquisition and control applications between a host and remote sensors. It is also useful for those applications where the installation of cable wire is inconvenient.

The wireless modem series is a spread spectrum radio modem with an RS-232 or RS-485 interface port. The module can be used not only in peer to peer mode, but also in a multi point structure.



Model Name	Radio		COM port	
	Frequency	Transmission Distance (LoS)	Interface	Baud rate (bps)
 RFU-400	429 MHz / 433 MHz	1000 m	RS-232/485	1200 ~ 115200
 RFU-2400	2.4 GHz	700 m	RS-232/485	2400 ~ 115200
 tRFU-2400	2.4 GHz	180 m	RS-232/422/485	2400 ~ 115200

Note: tRFU-2400 is PCB antenna.

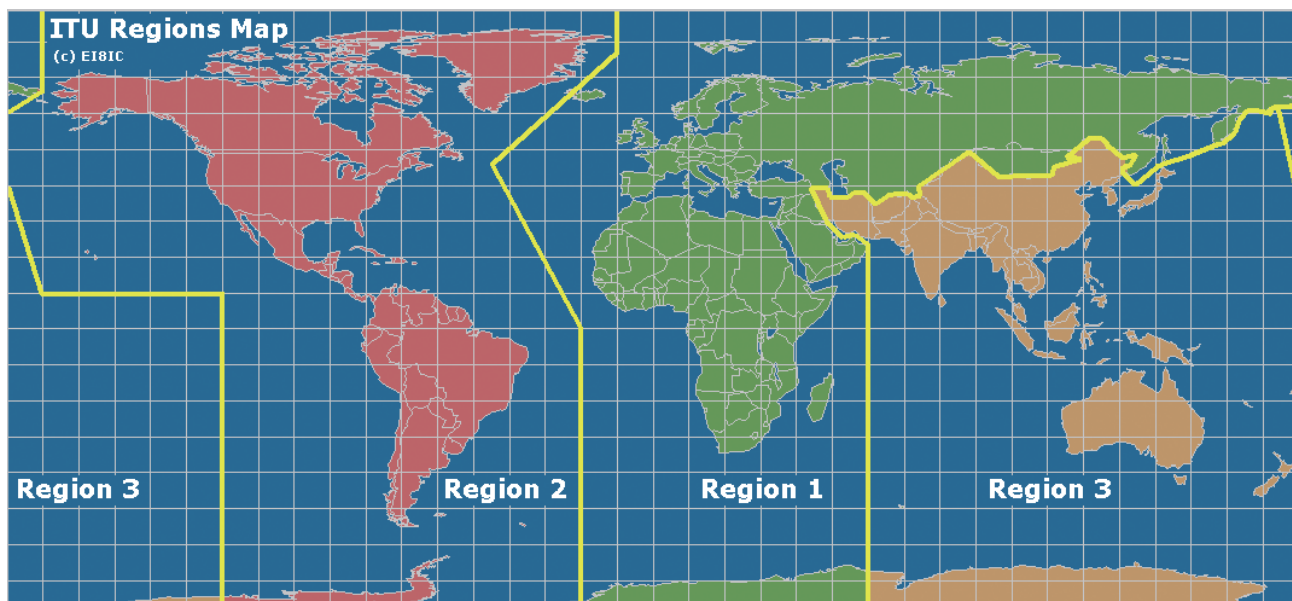

# 3. 3G/4G Products

## 3.1 SMS Remote Module

ICP DAS provides various intelligent 3G/4G modules and gateway, SMS-5xx Series. The Module is GSM remote control and alarm system allows users to use their mobile phone to monitor and control the business from any location. Its alarm facilities provide a flexible way to distribute critical alarm information to any number of mobile phone users. The Gateway allows user to access mobile phone by using standard protocol, such as Modbus.



Model Name	Interface	Frequency (MHz)	I/O	Alarm	Micro SD	Battery Backup	Transparent Communication	VxComm	3G Router
SMS-530	2 × RS-232	2G (GSM/GPRS): 850/900/1800/1900	2 × DO 10 × DI	Yes (SMS)	-	Yes	SMS		
SMS-531	2 × RS-232 1 × RS-485		-	Yes (SMS, Voice)	Yes	-	Modbus RTU	-	-
SMS-534	1 × RS-232 1 × RS-485	3G (UMTS/HSDPA/HSUPA): 850/900/1900/2100	2 × DO 6 × DI 1 × AI	Yes (SMS, Voice)	Yes	Yes	SMS		

### SMS Database System:

- Quickly and easily build a SMS-53x management system
- Support Windows 2K/XP/7/8/10
- Support MS SQL Server and MS Access 2003 Database
- Support SMS-530, SMS-531, and SMS-534
- Allow to view real-time or historical data of SMS messages sent by SMS-53x series
- Support filter function that enables to receive SMS messages by specific phone numbers
- Provide backup mechanism in local sites: when experiencing unexpected disconnection and not able to transmit and store data in remote SQL Server database, the data will be safely kept in local sites

### Introduction:

SMS Database System is a software allows to manage remote SMS-53x series more efficiently. SMS-53x series are intelligent GSM controllers great for use in industry applications; they feature easy-to-use interface, SMS tunnel function voice communication and can be powered with an external power supply or Li-Battery. They support UNICODE and 7 bit format that allows users to send SMS messages in various languages; the SMS messages can be sent at user-defined time or whenever a predefined DI/counter event is triggered. With SMS Database System, it enables remote monitoring and database system for SMS-53x, therefore, allows the 3rd party software tools being easily integrated with SMS-53x series as well as users' applications.

### Applications (Remote Maintenance):

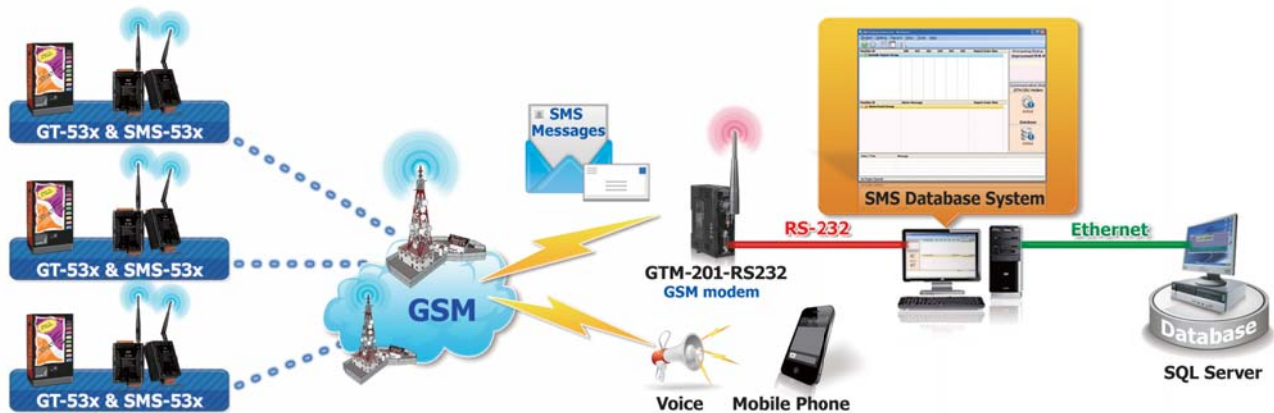

### Version Comparison:

Version	Max. Phone Number Supported	Database	License
SMS Database System Lite v1.0	3	MS Access 2003	Free
SMS Database System Pro v1.0	Unlimited	MS SQL Server / MS Access 2003	Charge

## 3.2 3G/4G Modem

ICP DAS provides various industrial Quad-band 2G or Tri-band 3G or LTE 4G modem. The modems utilize the 2G/3G/4G network for convenient and inexpensive data transfer from remote instruments, meters, computers or control systems in either live data or packet data. The modems have the integrated TCP/IP stack so that even simple controllers with serial communications ports can be connected to the modem without the need for special driver implementation.



Model Name	Frequency (MHz)	Reset Input	MIC Input Audio Output	GPS	TCP/IP Stack	Baud Rate (bps)	Interface	Driver	Case
GTM-203M-3GWA	2G (GSM/GPRS): 850/900/1800/1900	Yes	Yes	-	Yes	9.6K ~ 115.2K	USB2.0 RS-232	Windows XP/7/8/10, Windows Server 2012	Metal
	3G (UMTS/HSDPA/HSUPA): 2100/1900/900/850								
GTM-204M-4GE	2G (GSM/GPRS): 850/900/1800/1900								
	3G (UMTS/DC-HSPA+): 850/900/2100								
	4G (FDD LTE): B1/B3/B5/B7/B8/B20								

Model Name	Frequency (MHz)	GPS Interface	Max. Download Speed	AT Command	TCP/IP Protocol
I-8212W-3GWA	2G (GSM/GPRS): 850/900/1800/1900	-	115.2 Kbps	Yes	Yes
I-8213W-3GWA	3G (UMTS/HSDPA/HSUPA): 2100/1900/850				
I-8213W-4GE	2G (GSM/GPRS): 850/900/1800/1900 3G (UMTS/DC-HSPA+): 850/900/2100 4G (FDD LTE): B1/B3/B5/B7/B8/B20	Yes	100 Mbps		

## 3.3 Mini PAC with 3G/4G Communication

The G-4500 series is M2M (machine to machine) mini programmable controller with a cellular transceiver can monitor industrial equipment that sends live data to the monitoring system, providing real-time status. With optional GPS model, the G-4500 can also be a GPS tracking system. It can be used in vehicle management system or maritime system.



Model Name	OS	Interface	I/O	Frequency (MHz)	LCM (Dot)	GPS	Power Saving	Solar Charging	Case
G-4513-3GWA	MiniOS7	1 × Ethernet 1 × RS-232 1 × RS-485	3 × DO 3 × DI 8 × AI 1 × Relay	2G (GSM/GPRS): 850/900/1800/1900	-	-	YES	for 12V Lead- Acid Battery	Metal
G-4513D-3GWA					128 × 64	-			
G-4513P-3GWA					-	YES			
G-4513PD-3GWA						3G(WCDMA): 850/900/1900/2100	128 × 64	YES	
▶G-4514-4GAU	MiniOS7	1 × Ethernet 1 × RS-232 1 × RS-485	3 × DO 3 × DI 8 × AI 1 × Relay	2G (GSM/GPRS): 850/900/1800/1900	-	-	YES	for 12V Lead- Acid Battery	Metal
▶G-4514D-4GAU					128 × 64	-			
▶G-4514P-4GAU					-	YES			
▶G-4514PD-4GAU						3G (UMTS/DC-HSPA+): 850/900/1900/2100 4G (FDD LTE): B1/B2/B3/B4/B5/B7/B8/B20 4G (TDD LTE):B40	128 × 64	YES	

Note: ▶ Available soon



### 3.4 M2M RTU Module

Model Name	Interface	Frequency (MHz)	I/O	Alarm	Micro SD	Battery Backup	Transparent Communication	VxComm	3G Router
 GT-540-3GWA	1 × RS-232 1 × RS-485	2G (GSM/GPRS): 850/900/1800/1900	2 × DO 6 × DI 1 × AI	Yes (GPRS)	Yes	Yes	3G/GPRS	-	-
 GT-540P-3GWA	1 × RS-232 1 × RS-485 GPS	3G (UMTS/HSDPA/HSUPA): 850/900/1900/2100							

Model Name	Interface	Frequency (MHz)	I/O	Alarm	Micro SD	Battery Backup	Transparent Communication	VxComm	3G Router
 RMV-531	1 × RS-232 1 × RS-485	2G (GSM/GPRS): 850/900/1800/1900	-	-	-	-	3G/GPRS	Yes	-
 GRP-530M		3G (UMTS/HSDPA/HSUPA): 850/900/1900/2100							
 GRP-540M		2G (GSM/GPRS): 850/900/1800/1900 3G (UMTS/HSDPA/HSUPA): 2100/1900/850 4G FDD LTE: B1/B3/B5/B7/B8/B20					Yes		

#### M2M RTU Center:

- Support up to 1024 M2M RTU devices (256 units for free)
- Support NAPOPC.M2M server, EzDatalog and M2M API tool of ICP DAS
- Support: GT-540(P), GT-540(P)-3GWA, G-4500 serial, GRP-520
- Allow any Modbus device connecting to GPRS/Ethernet via RTU devices.
- RTU series Management tool
- Support Windows 2K/XP/7/8/10
- Easy and quick to build a Remote monitor system

#### Introduction:

The M2M RTU Center is a management software that has a strong core technology for handling data and lets the user save the trouble of dealing with large IO data. The RTU Center supports the G-4500 series, GT-540 and other RTU products from ICP DAS and allows users to manage these RTU devices remotely. It is not only monitor the local IO and GPS data but also IO data of Modbus RTU devices. With M2M RTU Center, users can easily establish a remote system by using EZ Data Logger or OPC Client of user's SCADA to access data.

#### Software Architecture and Application:

When users want to use the following software or others to their system with RTU products of ICP DAS, M2M RTU Center must be executed at the same time.



#### Product Support:

Model No.	Description
RTU firmware	Management Firmware that supports G-4500 Series
GT-540	Intelligent GPRS Remote Terminal Unit

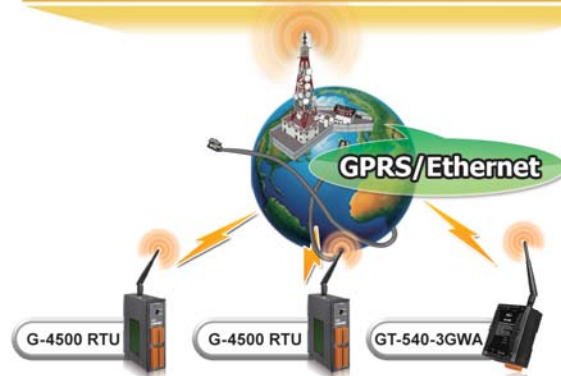

## 4. GPS Products

GPS (Global Positioning System) is widely used for driving navigation, geographic monitoring, fleet management and cargo tracking, etc. We also can use GPS for industrial application according to its longitude and latitude value and UTC time. ICP DAS provides various modules for different applications. Some are pure GPS data receivers and some add DO channels. Some even can generate a UTC synchronized 1 PPS (Pulse Per Second).



Model Name	GPS Channels	SBAS	GPS Output Interface	3G/4G	Digital Output	Protocol/Interface	Description
I-87211W	32	WAAS, EGNOS, MSAS	RS-232	-	2	DCON/*Note1	GPS Receiver and 2 DO Module
I-8213W-3GWA			*Note2	Yes (TCP/IP protocol) *Note3	-	-	GPS Receiver and GPRS Controller Module
I-8213W-4G series			USB *Note4	Yes (TCP/IP protocol) *Note4	-	-	GPS Receiver and 3G/4G Controller Module
GPS-721			RS-232	-	1	DCON/RS-485	GPS Receiver and 1 DO Module
GPS-721-MRTU			RS-232	-	1	Modbus RTU/ RS-485	GPS Receiver and 1 DO Module

**[\*Note1]** The support list of MCU (Main Control Unit) and I/O expansion unit are: XPAC, WinPAC, LinPAC, iPAC, ViewPAC, U-87P1/2/4/8, USB-87P1/2/4/8, I-8000, I-8KE4/8, I-8KE4/8-MTCP, I-87K4/5/8/9  
**[\*Note2]** Gets GPS Information from Parallel bus (API). The support list of MCU: XPAC, WinPAC, LinPAC, iPAC, ViewPAC, etc.  
**[\*Note3]** Gets GSM/GPRS Information from Parallel bus (API). This GPRS/GSM module is integrated with the TCP/IP protocol, Extended TCP/IP AT commands. The support list of MCU : XPAC, WinPAC, LinPAC, iPAC, ViewPAC, etc.  
**[\*Note4]** Gets GPS or 3G/4G Information from USB (API). This 3G/4G module is integrated with the TCP/IP protocol Extended TCP/IP AT commands. The support list of MCU:XPAC, WinPAC, LinPAC, etc.

## 5. Bluetooth LE Converters

The ICP DAS provides two kinds of Bluetooth low energy (LE) converters. One is the RS-232/RS-422/RS-485 to Bluetooth LE converter. The other is the USB to Bluetooth LE converter. The ICP DAS Bluetooth LE converter can combine into some existing systems that use RS-232, RS-422 or RS-485 network, and it can use smartphone, tablet or notebook as receiver. It will greatly to improve ease of use.



### RS-232/RS-422/RS-485 to Bluetooth LE Converter

Model Name	Bluetooth LE Standard	Interface	Data Rate	Transmit Range
tBLE-720	Bluetooth 4.0	RS-232/RS-422/RS-485	85 kbps	20 m (LOS)

### USB to Bluetooth LE Converter

Model Name	Bluetooth LE Standard	Interface	Data Rate	Transmit Range
BLE-USB	Bluetooth 4.0	USB	85 kbps	20 m (LOS)

# 6. ZigBee Products



## Features:



- ISM 2.4 GHz Operating Frequency and Fully Compliant with 2.4 G IEEE 802.15.4 / ZigBee PRO (2007)
- Support 3 Topologies Defined in the ZigBee Standard: Mesh, Star and Cluster Tree
- Support the 128-bit AES (Advanced Encryption Standard) Encryption
- GUI Configuration Software (Windows Version)
- ZigBee Node Supports Active Routing
- Supports Topology Utility for Network Monitoring and Improvement
- Wireless Transmission Range up to 700 m (Default)
- Provide Signal Strength LED Indicator
- Wide Operating Temperature (-25 ~ 75°C)

ZigBee is a specification based on the IEEE 802.15.4 standard for wireless personal area networks (WPANs). ZigBee operates in the ISM radio bands, and it defines a general-purpose, inexpensive, self-organizing, mesh network for industrial control, medical data collection, smoke and intruder warning, building automation and home automation, etc.

## ZigBee Converter:

Every network must have one host (coordinator) device for initializing, maintaining, and controlling the network; one or more slave devices (full function devices) are responsible for routing messages.

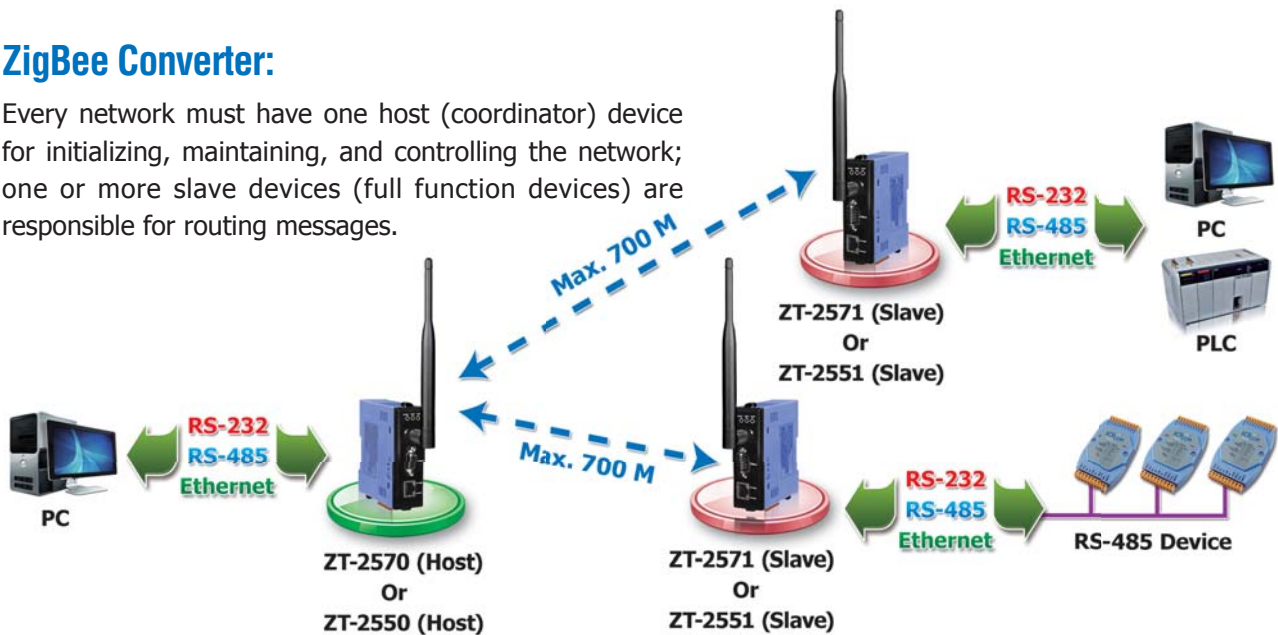

Model Name	Interface	Module Type	Transmit Power	Antenna	Distance (LOS)
ZT-2550	1 × RS-232 · 1 × RS-485	Host (Coordinator)	11 dBm	2.4 GHz, 5 dBi Omni-Directional antenna	700 m
ZT-2551	1 × RS-232 · 1 × RS-485	Slave (Router)	11 dBm	2.4 GHz, 5 dBi Omni-Directional antenna	700 m
ZT-2570	1 × RS-232 · 1 × RS-485 1 × Ethernet	Host (Coordinator)	11 dBm	2.4 GHz, 5 dBi Omni-Directional antenna	700 m
ZT-2571	1 × RS-232 · 1 × RS-485 1 × Ethernet	Slave (Router)	11 dBm	2.4 GHz, 5 dBi Omni-Directional antenna	700 m
ZT-USBC	1 × USB	Full Function (Coordinator/Router)	3 dBm	2.4 GHz, PCBantenna	60 m



## ZigBee Repeater:

The ZT-2510 is a ZigBee repeater to extend the distance of ZigBee network or avoid an obstacle that may be located between two wireless devices.

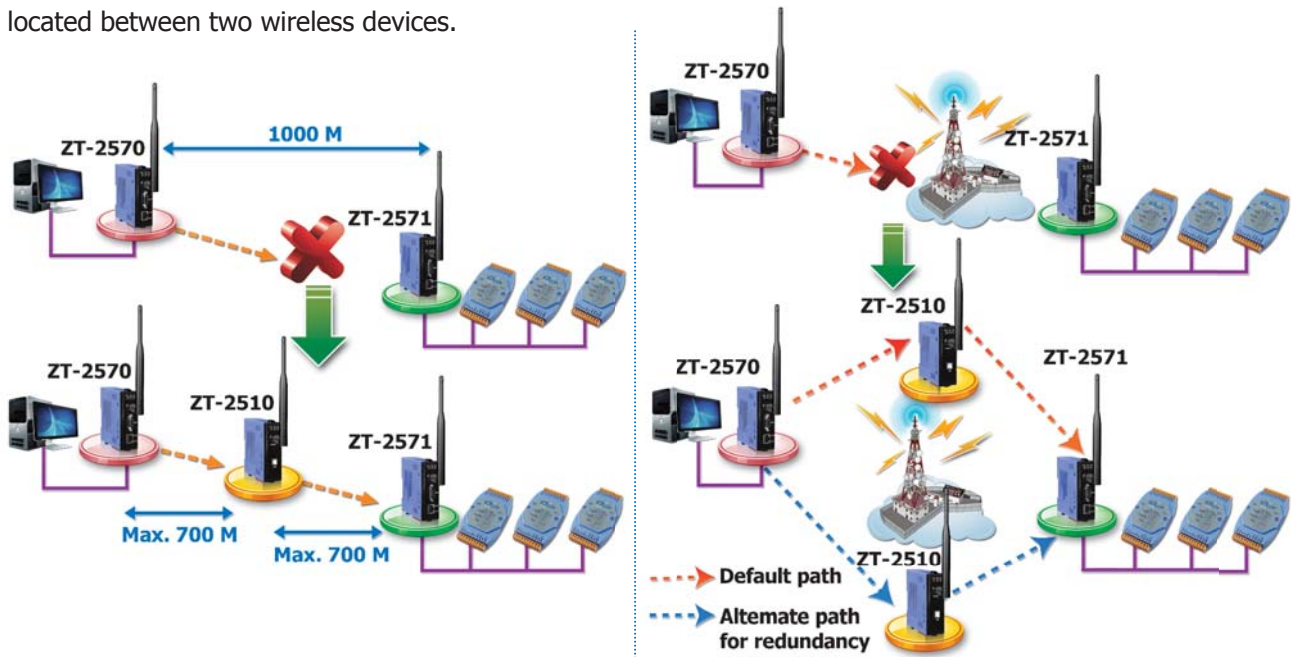

Model Name	Interface	Module Type	Transmit Power	Antenna	Distance (LOS)
ZT-2510	ZigBee	Slave (Router)	11 dBm	2.4 GHz, 5 dBi Omni-Directional antenna	700 m

## ZigBee Bridge:

The ZT-2530M is a ZigBee bridge operating as a bridge between two ZigBee networks. It is full hardware configuration, used to communicate indoor and outdoor units or divide complex network to enhance efficiency.

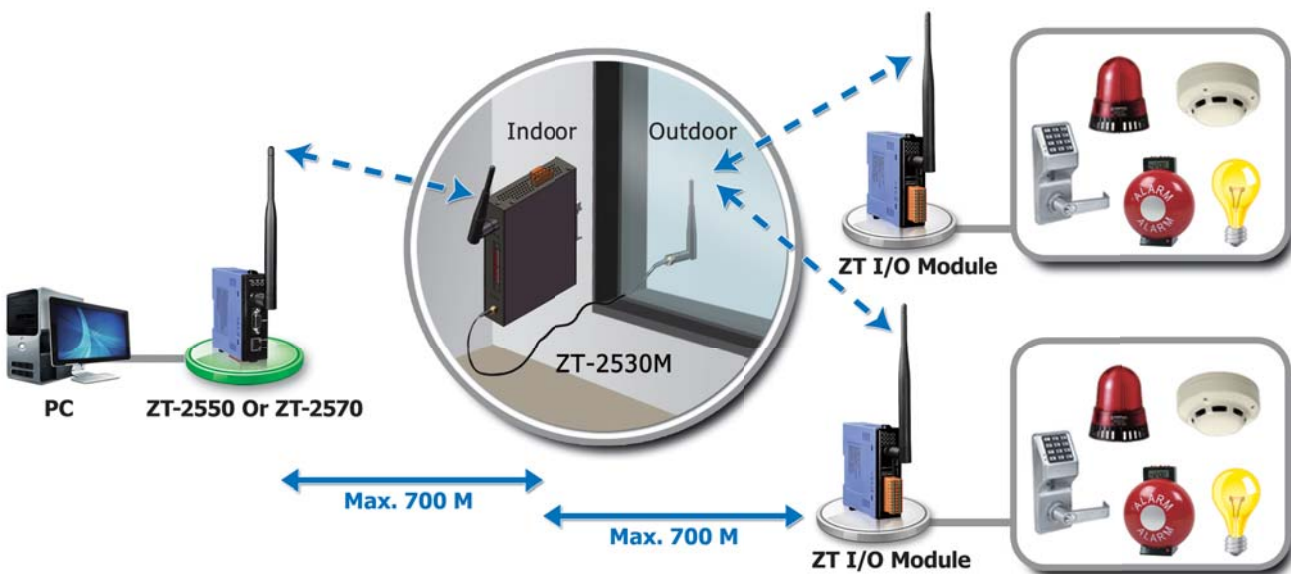

Model Name	Interface	Module Type	Transmit Power	Antenna	Distance (LOS)
ZT-2530M	ZigBee	Slave (Router) + Host (Coordinator)	11 dBm	2.4 GHz, 5 dBi Omni-Directional antenna	700 m

## ZigBee I/O Group Module (Full Function):



The ZT-20xx-IOG is a self-controller that no programming and no dealing with the wireless communication interference needs, but can quickly establish, monitor and manage the I/O pair-connection with the decentralized DIO channels. It suits the wireless I/O Pair-connection applications for the environment of needing many I/O points, large communication range and not easy wiring.

The ZT-20xx-IOG provides Ethernet, RS-232 or RS-485 communication interface. It is a data concentrator that no programming and no dealing with the wireless communication interference needs, but can quickly establish, monitor and manage the I/O pair-connection with the decentralized DIO channels. It suits the multi-host monitoring and I/O Pair-connection wireless applications for the environment of needing many I/O points, large communication range and not easy wiring.



Model Name	Channel	Type	Channel	Type
ZT-2043-IOG	DO: 14	Open Collector (700mA, Sink)		
ZT-2053-IOG	DI: 14	Dry/Wet (Sink/Source)		
ZT-2055-IOG	DI: 8	Dry/Wet (Sink/Source)	DO: 8	Open Collector(650 mA, Sink)
ZT-2060-IOG	DI: 6	Wet (Sink/Source)	DO: 4	Power Relay (5 A @ 250 VAC/30 VDC)



## ZigBee I/O Module (Router):

Model Name	Channel	Type	Channel	Type
ZT-2005-C8	AI: 8	10 K Thermistor (Measuring Temperature Range: -40°C ~ 105°C)		
ZT-2015	AI: 6	Pt100, Pt1000, Ni120, Cu100, Cu1000		
ZT-2017	AI: 8	±10 V, ±5 V, ±1V, ±500 mV, ±150 mV or -20 mA ~ +20 mA (Requires External 125 Ω Resistor)		
ZT-2017C	AI: 8	20 mA ~ +20 mA, 0 mA ~ +20 mA or +4 mA ~ +20 mA		
ZT-2018	AI: 8	±15 mV, ±50 mV, ±100 mV, ±500 mV, ±1V, ±2.5V, ±20 mA, 0 ~ 20 mA or 4 ~ 20 mA Thermocouple (J, K, T, E, R, S, B, N, C, L, M, LDIN43710)(Requires Optional External 125 Ω Resistor for current input)		
ZT-2024	AO: 4	0 ~ +10 VDC, -10 VDC ~ +10 VDC, 0 ~ +5 VDC, -5 VDC ~ +5 VDC, 0 ~ +20 mA, +4 mA ~ +20 mA		
ZT-2026	AI: 4	±10 V, ±5 V, ±1 V, ±500 mV, ±150 mV or -20 mA ~ +20 mA	AO: 2	±10 VDC, ±5 VDC, 0 ~ 10 VDC or 0 ~ 5 VDC
	DI: 2	Wet (Sink)	DO: 2	Open Collector (700 mA, Sink)
ZT-2042	DO: 8	4*PhotoMOS Relay (1 A, Sink/Source) / 4*Open Collector (700 mA, Sink)		
ZT-2043	DO: 14	Open Collector (700mA, Sink)		
ZT-2052	DI: 8	Wet (Sink/Source)		
ZT-2053	DI: 14	Dry/Wet (Sink/Source)		
ZT-2055	DI: 8	Dry/Wet (Sink/Source)	DO: 8	Open Collector (650 mA, Sink)
ZT-2060	DI: 6	Wet (Sink/Source)	DO: 4	Power Relay (5 A @ 250 VAC/30 VDC)

## ZigBee Accessories: External Antenna/Cable:



Optional Accessories	Description and Website
External Antenna	2.4 GHz External Antenna, RP-SMA Male (Plug)
External Antenna: <a href="http://www.icpdas.com/root/product/solutions/industrial_wireless_communication/wlan_products/external_antenna.html">http://www.icpdas.com/root/product/solutions/industrial_wireless_communication/wlan_products/external_antenna.html</a>	
External Cable	3S00x-1, RG58A/U x-meter long RP-SMA male to RP-SMA Female
Extension Cable: <a href="http://www.icpdas.com/root/product/solutions/accessories/cable/cable_selection.html">http://www.icpdas.com/root/product/solutions/accessories/cable/cable_selection.html</a>	

# 7. Infrared Wireless Modules

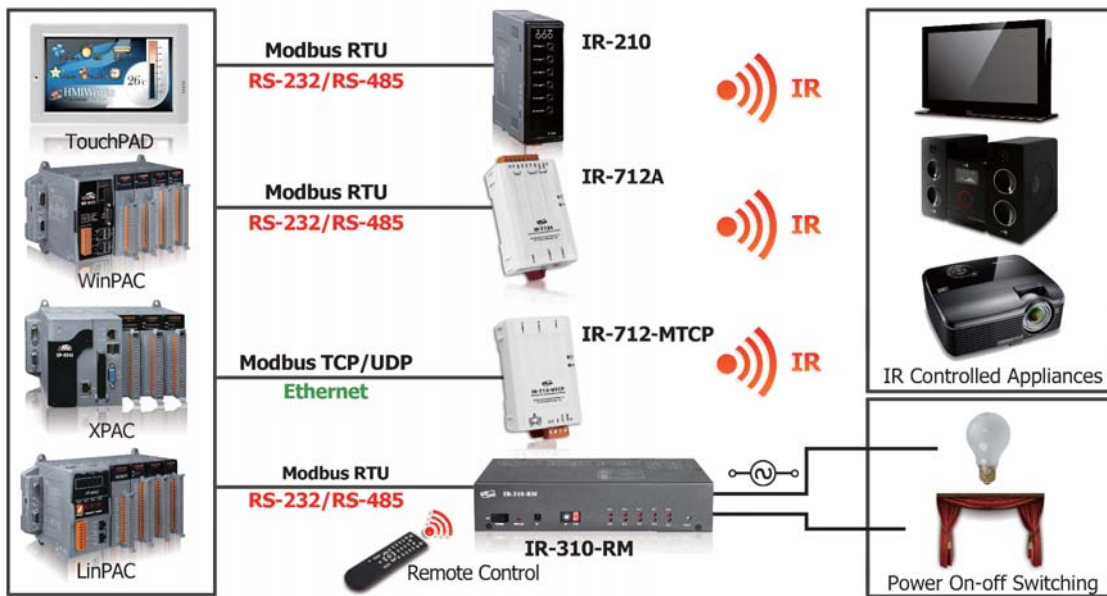

IR (infrared) technology is now used for controlling home devices including television, air conditioner and etc. ICP DAS has developed various IR products to apply in home automation. These IR products can help users to control and integrate these IR devices into a control system. Therefore, by integrating the PAC and others series of ICP DAS, users can easily establish the home automation system. IR Series includes "IR learning remote modules" and "IR controlled power relay module". The former are used to collect and transmit a variety of devices infrared remote commands, while the latter is a strong relay module with the electric remote control function.

## IR Smart Home Application

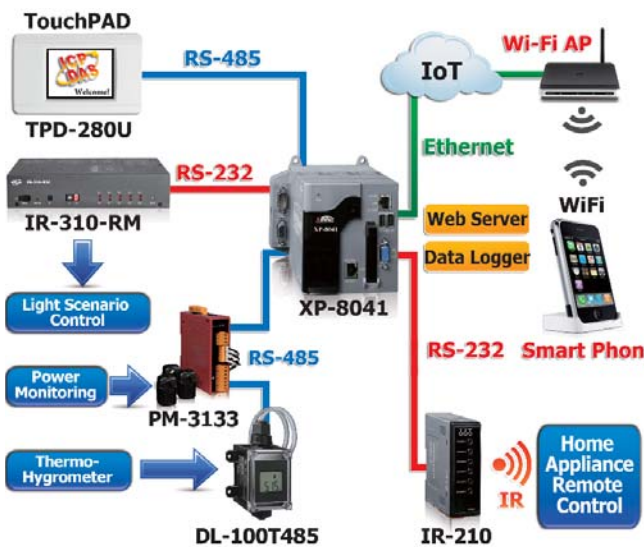

## IR + Wi-Fi Wireless Control Application

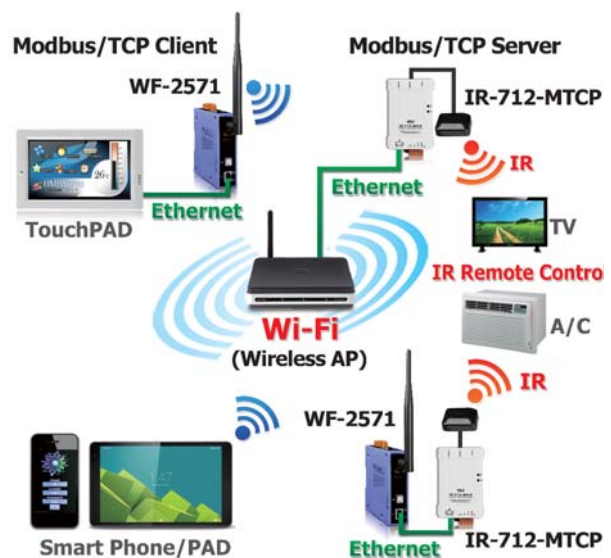

## Selection Guide:

Type	IR Learning Remote Modules			IR Controlled Power Relay Module
	IR-210	IR-712A	IR-712-MTCP	IR-310-RM
Model Name	IR-210	IR-712A	IR-712-MTCP	IR-310-RM
Output	IR Output × 6	IR Output × 2	IR Output × 2 Modbus TCP	Relay Output × 10
Included Cable	Two CA-IR-SH2251 (-5 model with -5 model cable) and one CA-0910		Two CA-IR-SH2251 (-5 model with -5 model cable)	One CA-IR-SH2251-5, one CA-IR-001, one CA-0910 and one remote control L108E



# Universal IR Learning Remote Module



**IR-210    IR-712A    IR-712-MTCP**

**Features:**



- IR Output: channels for remote controlling multiple devices
- IR Input: can learn and store IR Commands
- Supports 6 learning IR carrier frequencies
- Built-in Watchdog
- Provide LEDs: Transmitting / Learning / Power
- RoHS Compliance

ICPDAS universal IR learning remote module can learn IR remote commands of diverse electronic devices, and store the commands in the module or saved to a file. The RS-232/485/Ethernet interfaces provide flexible expansion and control the module. The software utility provides users with easy configuration, learning, test and storage of IR commands. It is well-designed for smart home and building automation.

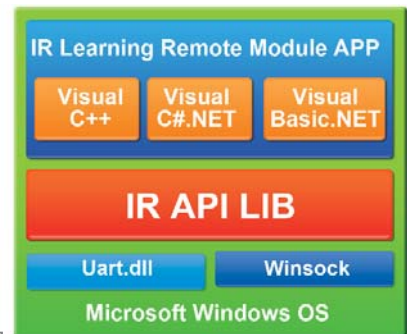

**IR Utility: configuration, IR learning and waveform display**

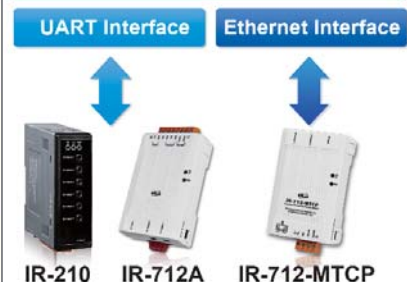
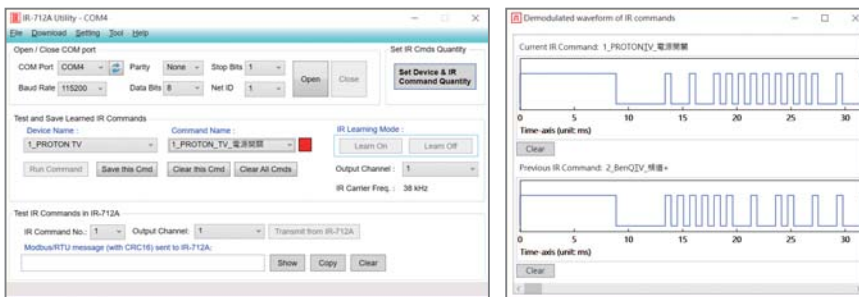

**ICPDAS PAC**

**WinCE PAC**

- XPAC**
- WinPAC**
- ViewPAC**

---

**Linux PAC**

**MiniOS PAC**

- LinPAC**
- µPAC**
- iPAC**
- ViewPAC**

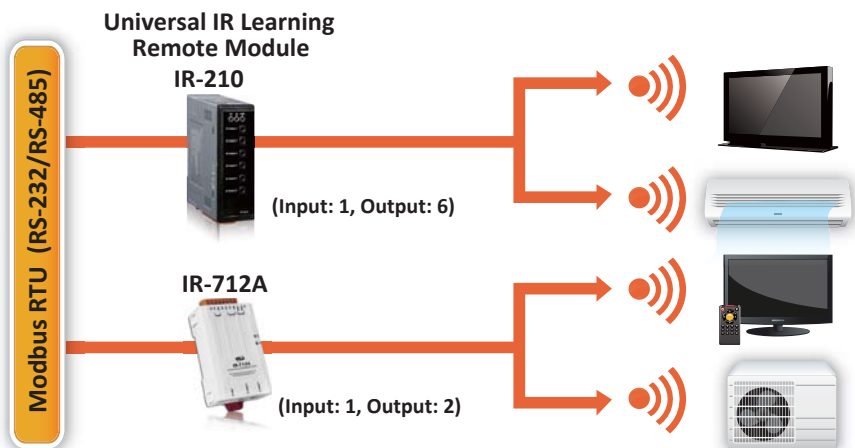

Model Name	IR-210	IR-712A	IR-712-MTCP
IR Output Channels	6	2	
IR Commands Storage	224	224	512
Support IR Carrier Freq.	33、36、37、38、40、56 kHz		
Serial Comm. Interface	RS-232 × 1 and RS-485 × 1		Ethernet × 1
Protocol	Modbus RTU (Slave)		Modbus TCP/UDP (Server)
Size (W × H × L) (mm)	33 × 107 × 78	52 × 93 × 27	52 × 85 × 27

# IR Controlled Power Relay Module



**IR-310-RM**

**Features:**



- 10 channels high power relays
- Supports IR commands for relay control
- NO & NC terminals for each channel
- Protection circuit for each channel
- Sequential relay control
- Support max. 5 sets of interlocked relay pairs
- Power-on values and power failure memory

IR-310-RM is a 10-channel high power relay module designed for the power control of various appliances. The application field can be manual/automatic power switch, light scenario control and energy saving etc.

Model Name	IR-310-RM
Relay Output	10 outputs (Form C)
Contact Rating	5 A @ 220 VAC × 6; 10 A @ 220 VAC × 4 (Operating temperature: 25°C)
Protocol Interface	Modbus RTU RS-232, RS-485
IR Commands	Self-defined: 64; built-in 32
IR Input	On-board IR receiver / Audio jack

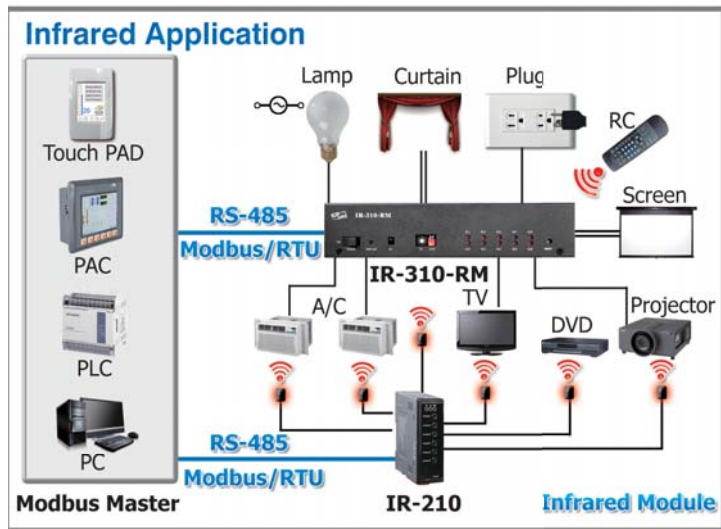

## IR Accessories & Usages:

IR series modules need to equip with an IR signal cable in order to transmit or receive infrared remote control signals. ICP DAS provides single-headed, dual-headed and semi-sphere-headed first-class IR cables to meet different wiring requirements. IR cable can be extended the distance according to the actual wiring situation.

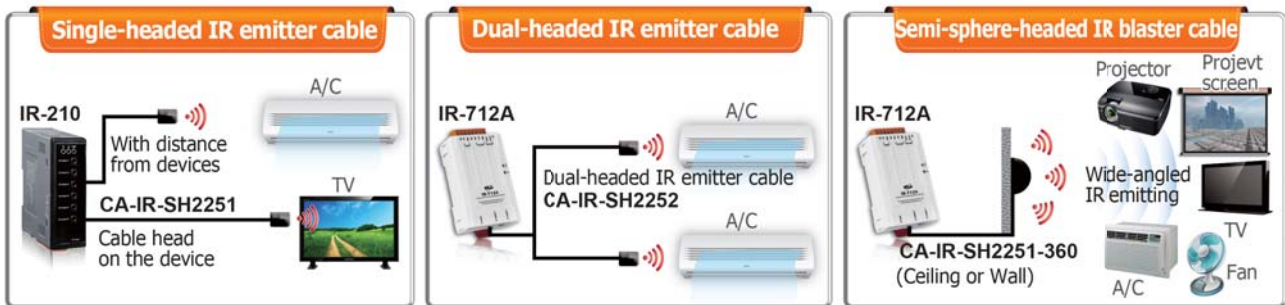

Model Name	Description
CA-IR-SH2251	Single-headed IR emitter cable (with adhesive pad, Ø 3 mm IRED, 2.5 m)
CA-IR-SH2252	Dual-headed IR emitter cable (with adhesive pad, Ø 3 mm IRED, 2.5 m)
CA-IR-SH2251-5	Single-headed IR emitter cable (with adhesive pad, Ø 5 mm IRED, 2.5 m)
CA-IR-SH2252-5	Dual-headed IR emitter cable (with adhesive pad, Ø 5 mm IRED, 2.5 m)

Model Name	Description
CA-IR-SH2251-360	Semi-sphere-headed IR blaster cable (with adhesive pad, 2.5 m)
CA-IR-SH1251-360	Semi-sphere-headed IR receiver cable (with adhesive pad, 2.5 m)
CA-IR-001	IR receiver cable, 3 m
L108E	IR learning remote control

<Note> The IR emitter cable can be extended up to 100 meters by Ethernet CAT 5 cable.

# 8. Wireless Modbus Data Concentrators

## Wi-Fi Modbus Data Concentrator

**Available soon**



**MDC-211-WF**

### Introduction:

MDC-211-WF is a Modbus Data Concentrator used to access data from disparate Modbus slave devices with a contiguous Modbus address table ranged by the concentrator. Up to 240 Modbus commands can be performed to read data from Modbus slave devices via Wi-Fi/RS-232/485, and up to 6 Modbus/TCP masters are allowed to get the polled data via the Ethernet. The Modbus/TCP masters directly read/write the data in the MDC-211-WF instead of polling each Modbus slave device one by one. This way not only makes the data on the Wi-Fi/RS-232/485 sharable to multiple Modbus/TCP master but also shorten the time to read/write data from/to multiple Modbus/RTU slave devices.

### Features:

- Compatible with IEEE 802.11b / g / n standards
- Support Infrastructure and Limit-AP mode
- Support WEP, WPA and WPA2 encryption mechanism
- Support data logger (MicroSD) function
- Support the Modbus TCP/RTU protocol
- Support the MQTT v3.1 Client protocol
- Support for up to 8 Modbus TCP masters
- Support Ethernet, RS-232/485 and Wi-Fi interfaces

### System Structure:

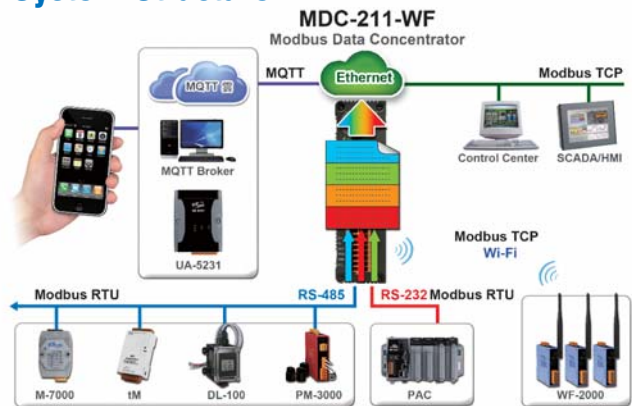

## ZigBee Modbus Data Concentrator

**Available soon**



**MDC-211-ZT**

### Introduction:

MDC-211-ZT is a Modbus Data Concentrator used to centrally manage decentralized I/O data via the ZigBee wireless mesh network. It access data from disparate Modbus slave devices with a contiguous Modbus address table ranged by the concentrator. Up to 240 Modbus commands can be performed to read data from Modbus slave devices via ZigBee/RS-232/RS-485, and up to 8 Modbus/TCP masters are allowed to get the polled data via the Ethernet. This way not only makes the data on the ZigBee/RS-232/RS-485 sharable to multiple Modbus/TCP master but also reduce the flow of ZigBee/Ethernet traffic load to improve the system performance. It is the best solution for users quickly establishing a remote monitoring system.

### Features:

- Fully Compliant with 2.4 G (IEEE802.15.4/ ZigBee Specifications)
- Upgrade ZigBee I/O modules with Ethernet communication ability
- Support the Modbus TCP/RTU protocol
- Support the MQTT v3.1 Client protocol
- Support I/O data logger (MicroSD) function
- Data pool for up to 9600 registers
- Modbus polling commands for up to 240 definitions
- Speed up the time for reading from ZT-2000 series modules
- Support ZigBee, Ethernet and RS 232/485 interfaces

### System Structure:

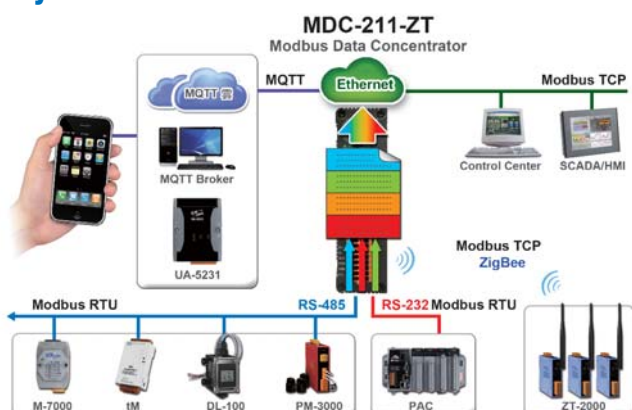



# Machine Automation

# 7

## 1 Motionnet Solutions P 7-1

- PCI Bus, Dual-line Motionnet Master Card - - - - - P 7-2
- Motionnet Single-axis Motion Control Modules - - - - - P 7-3
- Motionnet I/O Modules - - - - - P 7-4
- Motionnet 4 Port Hub Module - - - - - P 7-5

## 2 EtherCAT Motion Control Solutions P 7-6

## 3 Ethernet & Serial Communication Motion Control Solutions P 7-10

## 4 PC-based Motion Control Cards P 7-13

## 5 PAC Solutions - Motion Modules P 7-15

## 6 Features of Motion Function P 7-17

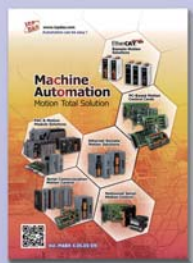

### Machine Automation Motion Total Solution - MA Brochure

- Motionnet Solutions
- EtherCAT Motion Control Solutions
- Ethernet Motion Control Solutions
- Serial Communication Motion Control Solutions
- PC-based Motion Control Cards
- PAC Solutions - Motion Modules
- Features of Motion Function

Or refer to <http://www.icpdas.com/root/support/catalog/pdf/Brochure/MABR-en.pdf>

Remote Motion Solutions

# 1. Motionnet Solutions

## Introduction:

Motionnet is a high-speed serial communication system that includes a Master card and Slave modules. ICP DAS provides two categories of Slaves: the first is used for Digital I/O, and the other is used for motion control. There are 3 main types of digital I/O modules: 32-ch Input, 32-ch Output and 16-ch Input/Output. Using these Slave devices, customers' actuators/sensors can easily be directly connected. Motion control modules can be used together with either a Servo motor or a Stepping motor from a variety of vendors.

Motionnet communication between a Master and the Slaves is based on a proprietary RS-485 technology (Multi-drop, Half-duplex) and provides the advantage of reduced wiring requirements together with the capability of long-distance and high-speed communication. Data transfer for the I/O modules is cyclical and time deterministic, so can be widely used for industrial automation applications.

## Features:

- Communication Speed: Max. 20 Mbps
- Communication Distance: Max. 100 m
- Controllable Modules: 64 modules per line
- Data Transfer Rate:
  - \* 15.1  $\mu$ sec/module  
(each module provides 32 I/O points)
  - \* 2048 points in 0.97 ms  
(when 64 modules are connected)

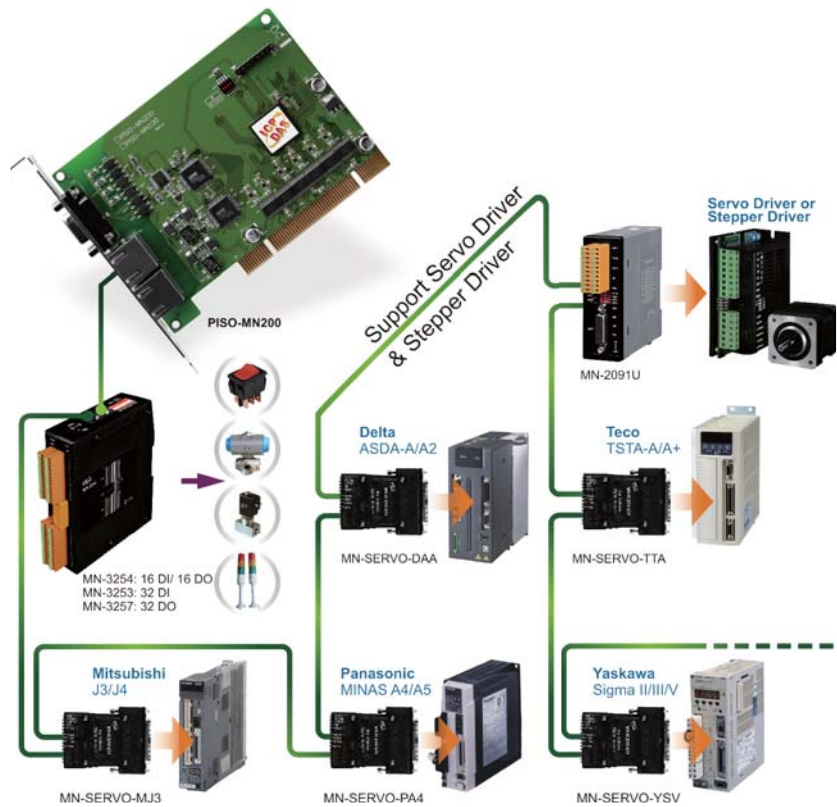

## Related Products:

Motionnet Solution Products of Remote Motion Solutions		
PCI Master Cards	PISO-MN200(T/EC)	PCI Bus, Dual-Line Motionnet Master Card
Motion Control Modules	MN-SERVO-xxx Series	MN-SERVO-MJ3 / PA4 / YSV / DAA / TTA: Motionnet Single-axis Motion Control Modules
	MN-SERVO-xxx-EC Series	Motionnet Single-axis Motion Control Modules with e-CON Mini-Clamp connector
	MN-2091U(-T)	Motionnet Single-axis Universal Motion Control Module
I/O Modules	MN-3254(T)	Motionnet 16-ch Isolated DI, 16-ch Isolated DO Module
	MN-3253(T)	Motionnet 32-ch Isolated DI Module
	MN-3257(T)	Motionnet 32-ch Isolated DO Module
	MN-D622-DIN	Motionnet 16-ch Isolated DI, 16-ch Isolated DO Module with Mini-clamp Connector
	MN-D640-DIN	Motionnet 32-ch Isolated DI Module with Mini-clamp Connector
	MN-D604-DIN	Motionnet 32-ch Isolated DO Module with Mini-clamp Connector
Hub Modules	MN-HUB4(EC)	Motionnet 4 port Hub module with RJ-45 Jack (RoHS) (EC: with e-CON Mini-Clamp connector)

# PCI Bus, Dual-line Motionnet Master Card

## (For Distributed Motion & I/O Control)



**PISO-MN200**



**PISO-MN200T**



**PISO-MN200EC**

### Introduction:

The **PISO-MN200(T/EC)** is a PCI Master card that provides two Motionnet serial communication lines for distributed motion and I/O control in machine automation applications. The Master card can be used to connect up to 128 Slave modules (64 × 2 lines). If one of the Motionnet lines is only used for I/O control, it can send/receive signals to/from 2048 points on 64 local devices within 0.97 msec. When it is used to control motors, it can control up to 64 axes, which can be used to execute continuous positioning motion, zero return and even multi-axis interpolation operations. In addition to serial communication, the PISO-MN200(T/EC) is also equipped with parallel I/O ports (8 input channels and 4 output channels) for rapid and instinctive I/O control.

### Specifications:

Bus	32-bit/33 MHz universal PCI-Bus
Communication Speed	2.5, 5, 10, 20 Mbps (Software controlled)
Interface	Half-duplex RS-485
Communication Length	Max. 100 M (20 Mbps; 32 Slave modules) Max. 50 M (20 Mbps; 64 Slave modules) Max. 100 M (10 Mbps; 64 Slave modules)
Communication Connector	PISO-MN200: RJ-45 × 2 PISO-MN200T: 5-pin terminal block PISO-MN200EC: Mini-Clamp connector × 2
I/O Connector	HD D-Sub 15-pin × 1
Parallel I/O	Digital input: 8-ch Photo-coupler Isolated (12-24 V, NPN or PNP) Digital output: 4-ch Photo-coupler Isolated (NPN or PNP)
LED Diagnostics	Connection (green) Communication Error (red)
Interrupts	Input Change of State, Communication Error
Operating Temp.	0 ~ +60°C
Storage Temp.	-20 ~ +80°C
Operating Humidity	10 ~ 85%; Non-condensing
Storage Humidity	5 ~ 95%; Non-condensing

### Software Support:

Windows Driver/DLL/Lib	Windows 7 32/64-bit Windows XP/2000 32-bit
Programming Tools	VC/VB/BCB

### Features:



- Maximum Communication Speed: 20 Mbps
- Distributed motion control up to 128 axes
- Distributed I/O points up to 4096 points
- Easy connection using RJ-45 phone jack, removable terminal block or Mini-Clamp connector
- Parallel I/O Ports: 8 Input and 4 Output channels
- Optional quadrature encoder input for linear scale or manual pulse generator input

### Ordering Information/Accessories:

Model No.	Description
<b>PISO-MN200 CR</b>	PCI Bus, Dual-line Motionnet Master Card with RJ-45 (RoHS)
<b>PISO-MN200T CR</b>	PCI Bus, Dual-line Motionnet Master Card with Terminal Block (RoHS)
<b>PISO-MN200EC CR</b>	PCI Bus, Dual-Line Motionnet Master Card with Mini-Clamp connector (RoHS)
MN-SERVO Series CR MN-SERVO EC Series CR	Motionnet Single-axis Motion Control Modules (With Spring Type Terminal Blocks; EC: with e-CON Mini-Clamp connector) (RoHS)
MN-HUB4 CR MN-HUB4EC CR	Motionnet 4 port Hub Module (RoHS)
MN-2091U CR MN-2091U-T CR	Motionnet Single-axis Universal Motion Control Modules (RoHS)
MN-3254 CR MN-3254T CR	Motionnet 16-ch Isolated DI, 16-ch Isolated DO Module (RoHS)
MN-3253 CR MN-3253T CR	Motionnet 32-ch Isolated DI Module (RoHS)
MN-3257 CR MN-3257T CR	Motionnet 32-ch Isolated DO Module (RoHS)



Mini Clamp Wiremount Plug			Applicable Wire		
ICP DAS Part No.	Cover Color	3M Part No.	AWG No.	Cross-sectional Area (mm <sup>2</sup> )	Finished External Diameter Φ (mm)
4PKD100000001	Gray	37103-2206-000FL	20 - 22	0.3 - 0.5	1.6 - 2.0
4PKD100000002	Red	37103-3101-000FL	24 - 26	0.14 - 0.3	0.8 - 1.0
4PKD100000003	Orange	37103-3163-000FL	24 - 26	0.14 - 0.3	1.2 - 1.6



# Motionnet Single-axis Motion Control Modules



## MN-SERVO Series    MN-SERVO EC Series    MN-2091U / MN-2091U-T

### Introduction:

The MN-SERVO and MN-2091U(-T) are used to expand the number of axes for distributed motion control on a Motionnet field bus. These extension slave modules are serially connected to the controller using a simple and affordable Cat.5 LAN cable, and one serial line can support up to 64 single-axis modules. The 26-pin HD D-Sub connector can be used to easily connect with various servo drivers and stepper drivers. ICP DAS also provides a variety of cables suitable for a range of brands of servo drivers, which further reduces the amount of wiring required between the drivers and the controller, making this an ideal solution for highly integrated machine automation applications.

After the module is connected to the servo driver, all you need to do is connect a serial LAN cable between the modules. One serial line can support up to 64 single-axis modules. ICP DAS provides a variety of motion control modules suitable for a range of brands of servo drivers, such as Mitsubishi MELSERVO-J3/J4, Yaskawa Sigma II/III/V, Panasonic MINAS A4/A5, Delta ASDA-A/A2 and Teco TSTA-A/A+.

### Specifications:

Communication Speed	2.5, 5, 10, 20 Mbps
Maximum Pulse Output Frequency	6.6 Mpps
Pulse Output Interface	OUT/DIR, CW/CCW
Pulse Output Counter	28-bit
Encoder Interface	CW/CCW, A/B phase
Encoder Counter	28-bit
Speed Profile	Trapezoidal/S-shaped Acc/Dec Driving
Home Mode	13 Types
Mechanical Switch Input	LMT+, LMT-, HOME, SD, EMG
Servo I/O Interface	Input: ALM, RDY, INP Output: SVON, ERC, ALM_RST
High-Speed Position Compare Output	5V TTL or 24V open collector
LED Diagnostics	Communication state (Link, Error) Mechanic Switch Input Internal 3.3V Power Termination Resistor Switch
Communication Connector	MN-2091U: RJ-45 × 2 MN-2091U-T: 5-pin terminal block

### Features:

- Maximum communication speed: 20 Mbps
- Maximum pulse output frequency: 6.6 Mpps
- Control up to 64 axes per line
- Multi-axis linear interpolation function
- 2-axis circular interpolation function
- Programmable T/S-curve acceleration and deceleration
- Change speed and position on the fly
- Slow down sensor, home sensor, positive and negative limit sensors for each axis
- Software limit and compare trigger output
- Three-way isolation for power, communication and I/O. (Provide better noise immunity and device protection)



### Ordering Information:

Model No.	Description
MN-SERVO-MJ3 CR MN-SERVO-MJ3-EC CR	Motionnet Single-axis Motion Control Module with Spring Type Terminal Blocks (EC: with e-CON Mini-Clamp connector) for Mitsubishi MELSERVO-J3/J4 (RoHS)
MN-SERVO-PA4 CR MN-SERVO-PA4-EC CR	Motionnet Single-axis Motion Control Module with Spring Type Terminal Blocks (EC: with e-CON Mini-Clamp connector) for Mitsubishi MELSERVO-J3/J4 (RoHS)
MN-SERVO-YSV CR MN-SERVO-YSV-EC CR	Motionnet Single-axis Motion Control Module with Spring Type Terminal Blocks (EC: with e-CON Mini-Clamp connector) for Yaskawa Sigma II/III/V (RoHS)
MN-SERVO-DAA CR MN-SERVO-DAA-EC CR	Motionnet Single-axis Motion Control Module with Spring Type Terminal Blocks (EC: with e-CON Mini-Clamp connector) for Delta ASDA-A/A2 (RoHS)
MN-SERVO-TTA CR MN-SERVO-TTA-EC CR	Motionnet Single-axis Motion Control Module with Spring Type Terminal Blocks (EC: with e-CON Mini-Clamp connector) for Teco TSTA-A/A+ (RoHS)

Model No.	Description
MN-2091U CR	Motionnet Single-axis Universal Motion Control Module with RJ-45 Connector (RoHS)
MN-2091U-T CR	Motionnet Single-axis Universal Motion Control Module with Terminal Block (RoHS)

# Motionnet I/O Modules



**MN-D6xx-DIN series**



**MN-325x series MN-325xT series**

## Introduction:

The MN-D6xx-DIN, MN-325x, MN-325xT Series is an I/O module for Motionnet systems, and is equipped with up to 32 isolated digital input channels and up to 32 isolated digital output channels. Each Motionnet communication line can be connected to up to 64 modules, meaning that the I/O can be expanded to up to 1024 input channels and 1024 output channels. The communication time required by each module is 15.1 us. If 64 modules have been connected, signals for 2048 points on 64 modules can be sent and received within 0.97 msec. The update of the I/O status is completed automatically through the Motionnet system at a constant interval, and setting interrupts for specific input points that the user wants to monitor can help prevent CPU time from being wasted by repetitive polling when there is nothing else for the issuing process to do.

## Accessories:

	4PKD1O0000001	4PKD1O0000002	4PKD1O0000003
Gray Mini Clamp Wiremount Plug	Red Mini Clamp Wiremount Plug	Orange Mini Clamp Wiremount Plug	

Mini Clamp Wiremount Plug		Applicable Wire			
ICP DAS Part No.	Cover Color	3M Part No.	AWG No.	Cross-sectional Area (mm <sup>2</sup> )	Finished External Diameter Φ (mm)
4PKD1O0000001	Gray	37103-2206-000FL	20 – 22	0.3 – 0.5	1.6 – 2.0
4PKD1O0000002	Red	37103-3101-000FL	24 – 26	0.14 – 0.3	0.8 – 1.0
4PKD1O0000003	Orange	37103-3163-000FL	24 – 26	0.14 – 0.3	1.2 – 1.6

## Specifications:

Models	DI		DO		Communication Connector	Case
	Channel	Type	Channel	Type		
MN-3253	32	Sink/Source (NPN/PNP)	-	-	2 × RJ-45 or 5-pin terminal block	Plastic
MN-3253T						
MN-3254	16	Sink/Source (NPN/PNP)	16	Sink/Source (NPN/PNP)		
MN-3254T						
MN-3257	-	-	32	Sink/Source (NPN/PNP)		
MN-3257T	-	-	32	Sink (NPN)		
MN-D604-DIN	-	-	32	Sink (NPN)	2 × mini-clamp	Aluminum
MN-D622-DIN	16	Sink (NPN)	16	Sink (NPN)		
MN-D640-DIN	32	Sink (NPN)	-	-		

## Features:



- Maximum communication speed: 20 Mbps
- Each Motionnet transfer line: connect modules up to 64
- Designing isolation protection: power, communication, I/O
- LED Diagnostics for communication and I/O status
- High current sinking capability (200 mA)

## Ordering Information:

Model No.	Description
MN-D622-DIN CR	Motionnet 16-ch Isolated DI, 16-ch Isolated DO Module with Mini-clamp Connector (RoHS)
MN-D640-DIN CR	Motionnet 32-ch Isolated DI Module with Mini-clamp Connector (RoHS)
MN-D604-DIN CR	Motionnet 32-ch Isolated DO Module with Mini-clamp Connector (RoHS)

Model No.	Description
MN-3253 CR	Motionnet 32-ch Isolated DI Module (with RJ-45 Connector; T: with Terminal Block) (RoHS)
MN-3253T CR	
MN-3254 CR	Motionnet 16-ch Isolated DI, 16-ch Isolated DO Module (with RJ-45 Connector; T: with Terminal Block) (RoHS)
MN-3254T CR	
MN-3257 CR	Motionnet 32-ch Isolated DO Module (with RJ-45 Connector; T: with Terminal Block) (RoHS)
MN-3257T CR	

# Motionnet 4 Port Hub Module



MN-HUB4

MN-HUB4EC

## Features:



- True Motionnet Star Wiring Hub
- Independent Motionnet transceiver for each channel
- Maximum communication speed: 20 Mbps
- LEDs for indicating each Motionnet activity
- RJ-45 jack for standard module while the EC module equipped with Mini-Clamp connector
- DIN-Rail Mounting

## Introduction:

In some user's application, users may encounter some difficulty in wiring since the standard Motionnet only support daisy-chain topology. The MN-HUB4 series modules can help users to use star or tree topology during wiring which not only can make the wiring more easier but also reduce the total wiring distance and cost.

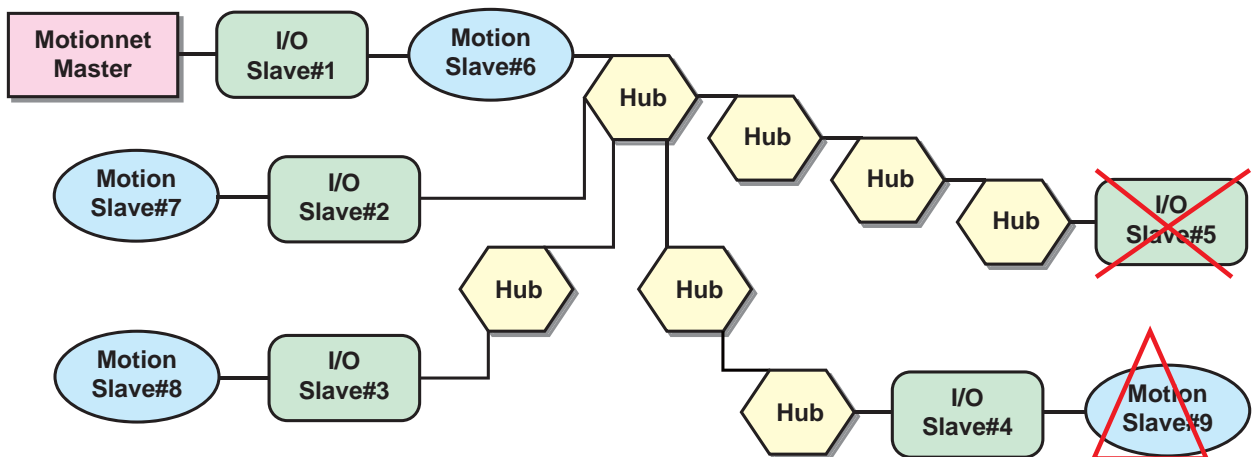

Module ID	No. of Layers to Master	Accessible	Module ID	No. of Layers to Master	Accessible
1 (I/O)	0	Yes	6 (Motion)	0	Yes
2 (I/O)	1	Yes	7 (Motion)	1	Yes
3 (I/O)	2	Yes	8 (Motion)	2	Yes
4 (I/O)	3	Yes	9 (Motion)	3	Yes
5 (I/O)	4	No			

Motion Modules	No. of Layers between Modules	Interpo-lation	Motion Modules	No. of Layers between Modules	Interpolation
6 and 7	1	Yes	7 and 8	2	Yes
6 and 8	2	Yes	7 and 9	3	No
6 and 9	3	No	8 and 9	4	No

## Ordering Information:

Model No.	Description
MN-HUB4 CR	Motionnet 4 port Hub module (with RJ-45 Jack)
MN-HUB4EC CR	Motionnet 4 port Hub module (with e-CON Mini-Clamp connector)
MN-HUB4EC-O CR	Motionnet 4 port Hub module and 6 "4PKD100000003" Orange e-CON Mini-Clamp connector
MN-HUB4EC-R CR	Motionnet 4 port Hub module and 6 "4PKD100000002" Red e-CON Mini-Clamp connector



## 2. EtherCAT Motion Control Solutions

### Introduction:

EtherCAT (Ethernet for Control Automation Technology) is an open, high-performance fieldbus system that makes Ethernet technologies available at the I/O level. EtherCAT provides flexible wiring, fast communication and many other nice features. It needs a master to control many slaves. ICP DAS provides PC master cards, ECAT-8000 and ECAT-8001, for users to build their applications including motion control. These cards can offer multi-axis motion and I/O control functions by their own built-in CPU. In this way, the CPU loading of PC can be reduced dramatically. In the mean while, ICP DAS also provides many I/O slave modules for users to choose from. Since EtherCAT technology is an industrial standard, those modules can work together in a system with 3rd-party EtherCAT slaves as well.

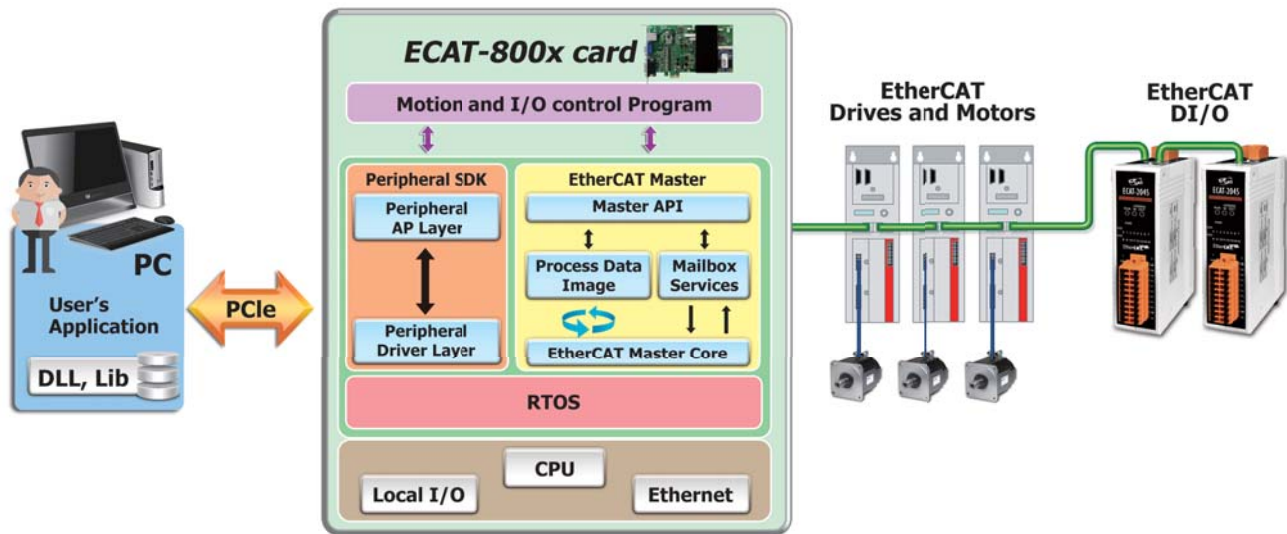

- **Versatile Motion Functions**  
P-to-P, Line, circle, 3D-arc, helix and other motion functions are provided.
- **Networking Standards**  
The ECAT-800x card is based on EtherCAT and CiA402 standards for precise multi-axis control. Third-party EtherCAT I/O slaves are also supported.
- **Programming API**  
Fast application implementation is enabled by using motion API provided by ICP DAS.

### Applications:

- Packaging
- Material handling
- Textile
- Printing and automotive applications
- Machine tools
- Robotics
- Industrial automation

- **Flexible and Easy Wiring**  
EtherCAT is a network technology which makes the system wiring easy and cost effective. Various coupler and junction slaves are provided for flexible wiring and less cabling.

### Related Products:

EtherCAT Solution Products of Remote Motion Solutions		
Master Cards	ECAT-8000 ECAT-8001	PCIe EtherCAT Master Card
Motion Control Modules	ECAT-2092(T) ECAT-2093	EtherCAT Encoder Modules
	ECAT-2091S ECAT-2094S ECAT-2098S	EtherCAT Stepping Motor Driving Modules
I/O Modules	ECAT-2011H ECAT-2012H ECAT-2013H ECAT-2015 ECAT-2016 ECAT-2017 ECAT-2019	EtherCAT Analog Input Modules
	ECAT-2024 ECAT-2028	EtherCAT Analog Output Modules
	ECAT-204x ECAT-205x ECAT-206x	EtherCAT Digital Input/Output Modules
	ECAT-2511-A ECAT-2511-B	EtherCAT to Single-mode Fiber Converters
Converters	ECAT-2511-A ECAT-2511-B	EtherCAT to Single-mode Fiber Converters
Junction Slave Modules	ECAT-2512 ECAT-2513	EtherCAT Junction Slave Modules
Gateway	ECAT-2610 ECAT-2611	EtherCAT Gateway Modules

## EtherCAT Master Cards:

PCIe, EtherCAT Master Card



Model Name	ECAT-8000	ECAT-8001
<b>Communication Interface</b>		
Connector	1 × RJ45, 100 Mbit/s	
Protocol	EtherCAT Master	
No. of Slave Node	Max. 32	
No. of Motion Control	Max. 16-Axis Synchronously	
<b>Digital Output</b>		
Channels	12	13
Output Type/Max load Current	Sink(open collector) / 100mA /ch	
<b>Digital Input</b>		
Channels	12	13
Type	Wet (Sink/Source)	
<b>Encoder</b>		
Axis	-	2 (Type: A/B Phase, CW/CCW, Pulse/Dir.)
Speed, Resolution	1 MHz, 32-bit	
Compare Trigger Output	2-ch	

## EtherCAT Motion Control Modules:

Encoder Module



Model Name	Axis	Type	Operating Voltage	Speed	Counter	Compare Trigger Out	Hardware Latch	Hardware Reset
ECAT-2092	2	1. A/B Phase	5/24 V (Jumper Select)	6 MHz (5V)	32-bit	-	Yes	Yes
ECAT-2092T	2	2. CW/CCW				2 (Open Collector)	Yes	Yes
ECAT-2093	3	3. Pulse/Dir.				-	-	-

Stepping Motor Driving Module



Model Name	Driver					Encoder				
	Axis	Type	Resolution	Output Current	Voltage Range	Axis	Type	Operating Voltage	Resolution	Speed
ECAT-2091S	1	2-phase stepper motor	200 × 256	2A per axis	5 ~ 40 V	1	A/B Phase	5 V	32-bit	1 MHz
ECAT-2094S	4					-	-	-	-	-
ECAT-2098S	8					-	-	-	-	-

EtherCAT Gateway Modules

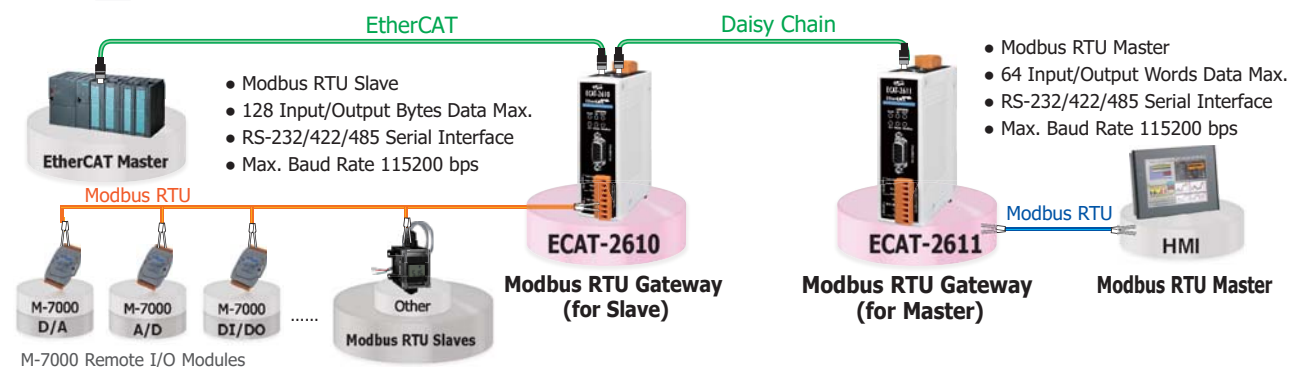

## EtherCAT I/O Modules:



### Analog Input Module

Model Name	Channel	Input Range	Resolution	Accuracy	Sampling Rate
ECAT-2011H	8/16	0 ~ 10 V, ±10 V, ±5 V, ±2.5 V, 0 ~ 20 mA, ±20 mA or 4 ~ 20 mA (Software selectable)	12-bit	0.2% of FSR	1k Hz/per channel
ECAT-2012H			14-bit		10k Hz/per channel
ECAT-2013H			16-bit		
ECAT-2015	6	Pt100, Pt1000, Ni120, Cu50, Cu100, Cu1000	16-bit	0.1% of FSR	10 Hz (Total)
ECAT-2016	2	Full-Bridge Strain Gauge	16-bit	0.05% of FSR	2/10 Hz (Total)
ECAT-2017	8	±150 mV, ±500 mV, ±1 V, ±5 V, ±10 V, ±20 mA, 0 ~ 20 mA, 4 ~ 20 mA	16-bit	0.1% of FSR	10 Hz (Total)
ECAT-2019	8	J, K, T, E, R, S, B, N, C, L, M, LDIN43710, ±20 mA, 0 ~ +20 mA, +4 ~ +20 mA, ±15 mV, ±50 mV, ±150 mV, ±500 mV, ±1 V, ±2.5 V, ±5 V, ±10 V (Jumper selectable)	16-bit	0.1% of FSR	10 Hz (Total)

### Analog Output Module

Model Name	Channel	Output Range	Resolution	Accuracy	Output Capability
ECAT-2024	4	±10 V, ±5 V,	12-bit	±2 LSB	10 V @ 5 mA
ECAT-2028	8	0~10 V, 0 ~ 5 V			

### Digital I/O Module

Model Name	Digital Input		Digital Output		
	Channels	Type	Channels	Type	Max. Load
ECAT-2057	-	-	16	Open Collector (Source)	100 mA
ECAT-2057-NPN	-	-	16	Open Emitter (Sink)	100 mA
ECAT-2057-8P8N	-	-	8	Open Collector (Sink)	100 mA
			8	Open Emitter (Source)	100 mA
ECAT-2045	-	-	16	Open Collector (Sink)	700 mA
ECAT-2045-32	-	-	32	Open Collector (Sink)	600 mA
ECAT-2051	16	Dry (Source), Wet (Sink/Source)	-	-	-
ECAT-2051-32	32	Dry (Source), Wet (Sink/Source)	-	-	-
ECAT-2050	13	Dry (Source), Wet (Sink/Source)	4	Open Collector/ Emitter by Jumper Selectable	100 mA
ECAT-2052	8	Wet (Sink/Source)	8	Open Collector (Source)	100 mA
ECAT-2052-NPN				Open Collector (Sink)	
ECAT-2053	16	Wet (Sink/Source)	-	-	-
ECAT-2055	8	Dry (Source), Wet (Sink/Source)	8	Open Collector (Sink)	700 mA
ECAT-2055-32	16	Dry (Source), Wet (Sink/Source)	16	Open Collector (Sink)	700 mA
ECAT-2060	6	Dry (Source), Wet (Sink/Source)	6	Relay, Form A (SPST-NO)	5 A
ECAT-2061	-	-	16	Relay, Form A (SPST-NO)	5 A

## EtherCAT Converter Modules: **NEW**

ECAT-2511-A ECAT-2511-B	EtherCAT to Single-mode Fiber Converter
----------------------------	---

The ECAT-2511-A and ECAT-2511-B are EtherCAT to single-mode fiber optic converter. They are designed not only to convert EtherCAT signals to optical signals on a fiber optic cable, to reshape the EtherCAT signal to compensate for distortion, but to isolate the bus error due to the wire short or disturbance. With the advantage of fiber optic, the ECAT-2511-A and ECAT-2511-B enable secure data transmission via fiber optic transmission, and helps the EtherCAT network to prevent the noise from EMS/RFI interference.

- EtherCAT Type: RJ45, 100 Base-TX
- Fiber Type: SC, Single mode, 100 Base-FX
- Fiber Cable: 8.3/125, 8.7/125, 9/125 or 10/125 μm
- Max. transmission distance up to 25 km
- Fiber Wavelength:
  - Tx: 1310 nm, Rx: 1550 nm for ECAT-2511-A
  - Tx: 1550 nm, Rx: 1310 nm for ECAT-2511-B

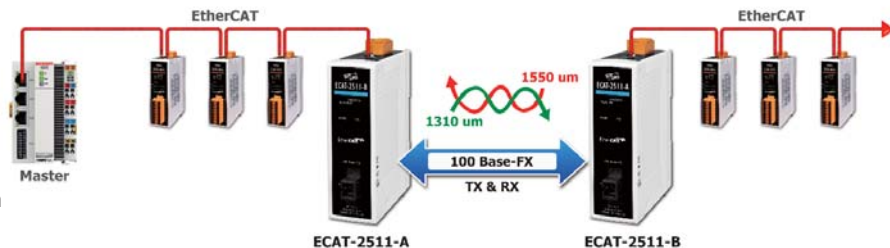



## EtherCAT Junction Slave Modules: *NEW*

ECAT-2512 ECAT-2513	Junction Slave
------------------------	----------------

ECAT-2512 and ECAT-2513 are 1-to-2 port and 1-to-3 port EtherCAT junction slaves. They are designed for realizing flexible wiring by daisy chain and branch.

Model Number	ECAT-2512	ECAT-2513
No. of Port	3 × RJ45 (1 in, 2 out)	4 × RJ45 (1 in, 3 out)
No. of Node	1	2

### Benefit 1: Translate Daisy-chain to Branch Topology

EtherCAT junction slaves can realize branch topology. This makes the cabling easier than daisy-chain topology.

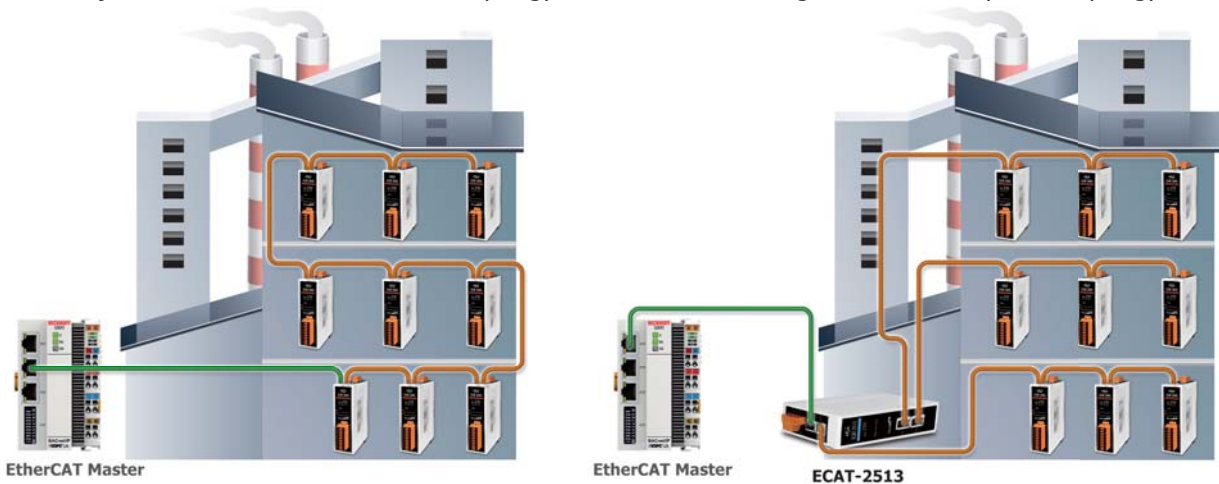

### Benefit 2: Improving the Debugging Efficiency

If a slave device is not working or the cable is disconnected, the following slave devices on the same network all not communicate with the master controller. With EtherCAT junction slaves, all slave devices can be wired as separated sections. If one slave device failed, only the slave devices on the same section will be influenced. The EtherCAT junction slave keeps the slave devices on another section communicate with the master controller. Debugging can be made separately, thus improving the debugging efficiency.

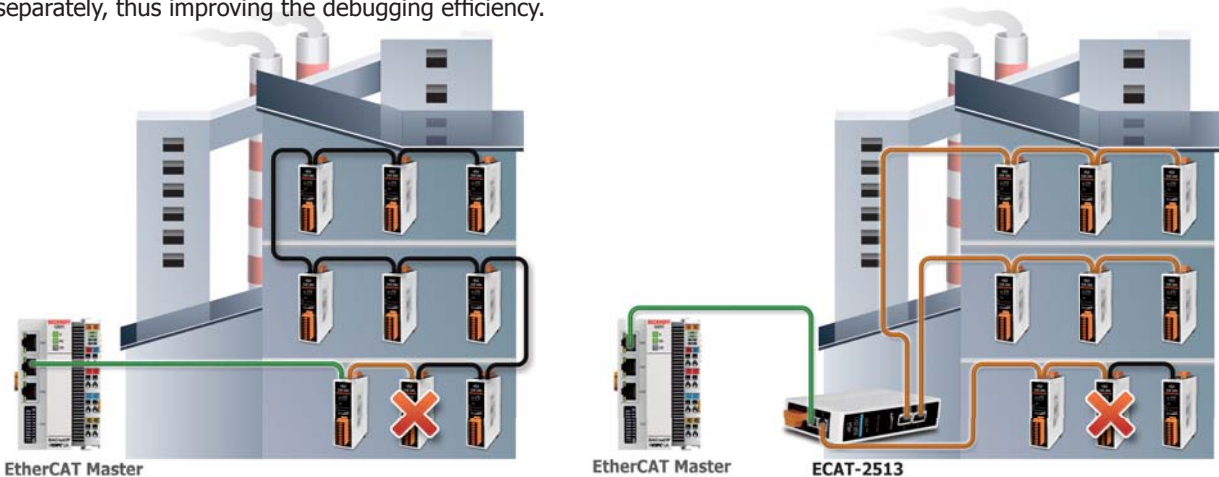

# 3. Ethernet & Serial Communication Motion Control Solutions

## Ethernet Motion Control Solutions:

ICP DAS remote Ethernet motion control series consist of a four axis (ET-M8194H) and a six axis (ET-M8196F) stepping/pulse-type servo motion controller. Each motion control device is equipped with an Ethernet communication module and uses Modbus TCP/IP as its communication protocol. In a Modbus TCP network the ET-M8194H/ET-M8196F acts as a server. All standard Modbus function codes are supported and therefore any Modbus TCP master (e.g. PC, PLC, HMI, PAC, etc.) can access the remote motion controller. Each device is equipped with two Ethernet ports which allow daisy chain Ethernet wiring; multiple devices can be connected together in sequence without an additional Ethernet switch. This intelligent motion controller has a variety of built in motion control functions, such as multi-axis linear interpolation, circular interpolation, T/S-curve acceleration/deceleration, various synchronous actions and automatic homing. A software utility assists the user in configuring the Ethernet module and motion card and provides some basic motion commands for testing. An application programming interface (API) allows the programmer to develop an application program to remotely control the motion device.

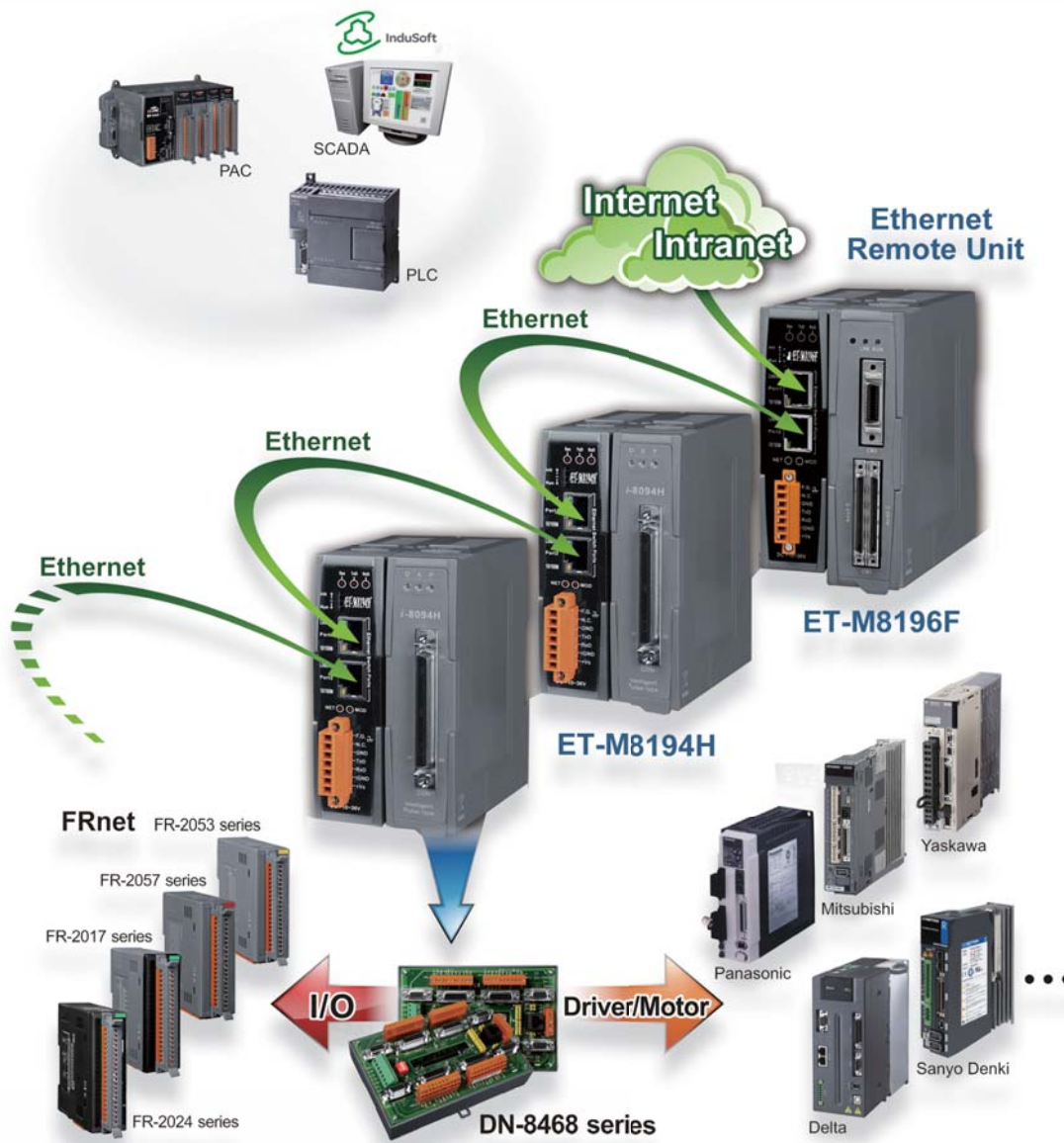

## Serial Communication Motion Control Solutions:

ICPDAS provides two types of remote serial motion controller: 4 and 6 axes stepping/pulse-type motion controller. Both controller types support RS-232, RS-485 and RS-422 serial communication and uses Modbus RTU as a communication protocol. Serial communication speed can be set by selecting a standard baud rate. The remote controllers are defined as a Modbus slave. The standard Modbus functions are supported which enables the user to easily integrate the motion controller into an existing Modbus network. PC, HMI, PAC, PLC and other devices which support Modbus RTU can access, control and monitor the motion controller. Software utilities are provided which allows the user to configure the device and execute simple motion commands for testing purposes. Windows APIs for developing motion control application are included in the software package.

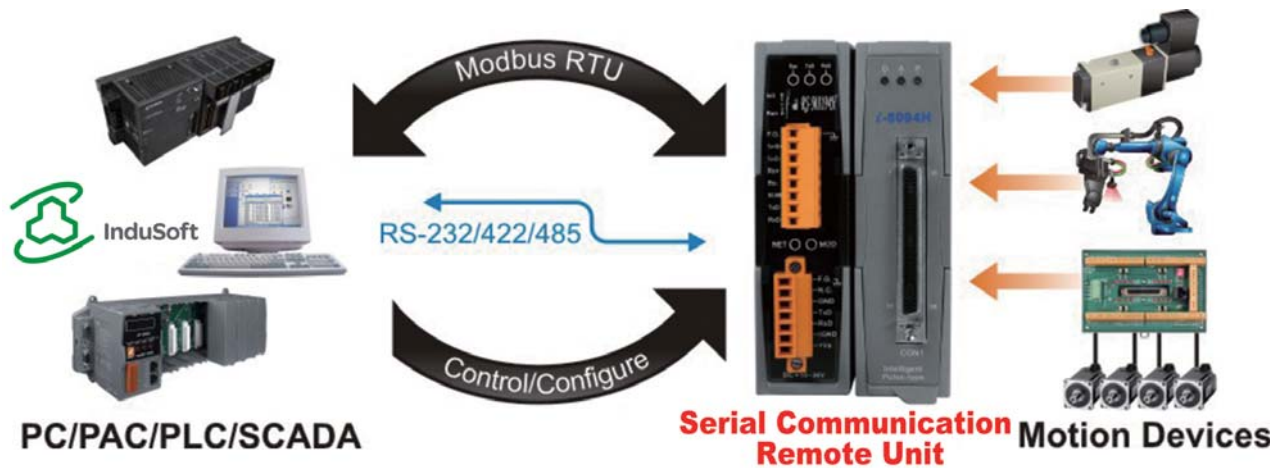

## Remote Motion Control Units:



- Compact Size
- Easy to Use
- Stand-alone



ET-M8194H



RS-M8194H



ET-M8196F



RS-M8196F

Model Name	ET-M8194H	RS-M8194H	ET-M8196F	RS-M8196F
Communication	Ethernet	Serial	Ethernet	Serial
Number of axes	4 axes		6 axes	
<b>Motion Control</b>				
Motion control type	IC chip based		DSP-based	
Command speed	4 Mpps			
Linear interpolation	2/3-axis		2- to 6-axis	
Circular interpolation	2-axis		2- to 3-axis	
Helical interpolation	-		3-axis	
Macro programming	Yes		-	
Buffer mode	stores up to 24 motion commands		stores up to 5000 motion commands	
Encoder counter	High-speed (4 Mhz)		High-speed (up to 12 MHz)	
Compare trigger	High-speed (4 Mhz)			
Auto-increment compare mode	-		High-speed (4 Mhz)	



## Applications:

### • Ethernet Motion Control Application

In a recent case, ET-M8194H units were installed on machines performing IC inspection. Each machine was equipped with two ET-M8194H modules to coordinate six motors by taking advantage of the embedded Ethernet switching ports on the ET-M8194H. Therefore six axes motion control could be easily implemented by connecting two ET-M8194H modules in series (daisy-chain topology). The supervisory host PC was used to issue commands and collect information through the Ethernet without the need for additional wiring. The application can also be accomplished by using the ET-M8196F.

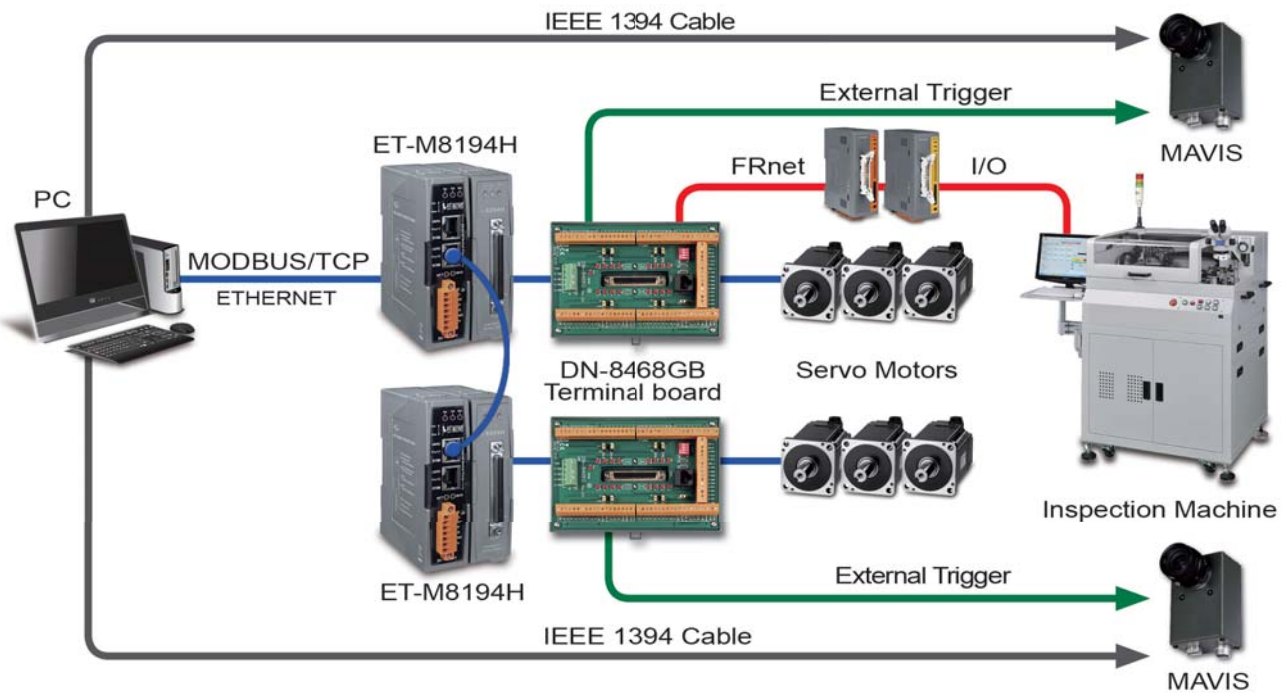

### • Serial Communication Motion Control Application

In a recent case, a PLC together with a RS-M8194H was used to control the dispensing path of an automated dispensing system. With the three-axis interpolation function provided by RS-M8194H it was possible to move two dispensing nozzles synchronous along predefined curves with varying velocities. It was a requirement to change the velocity on the fly in order to ensure a set dispensing thickness along the motion path.

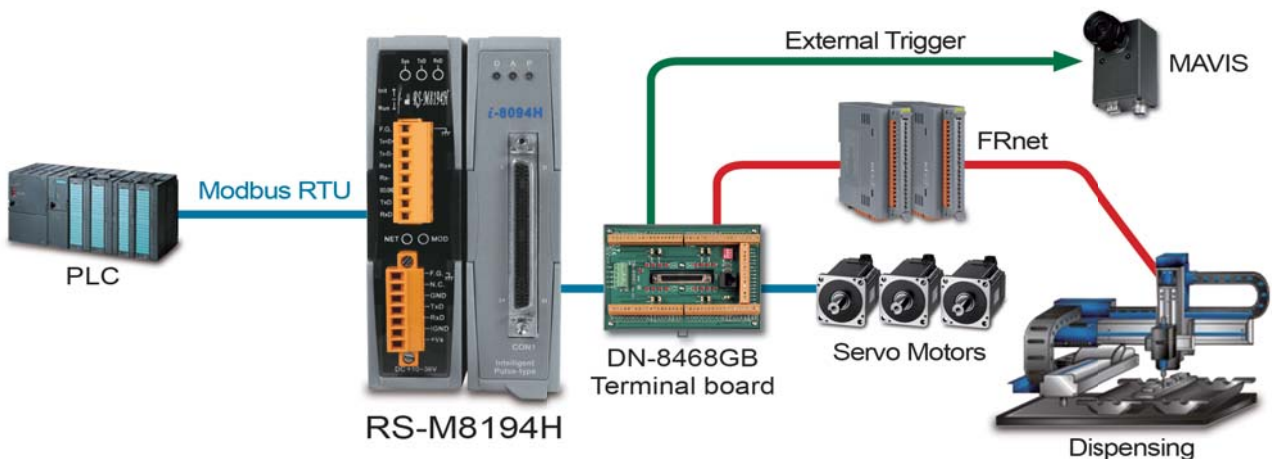

PC-based Solutions

# 4. PC-based Motion Control Cards

## Introduction:

As a leading automation solutions provider, ICP DAS not only provides PAC solutions, but also develops PC-based solutions for machine automation applications, including the PCI bus motion control cards and the ISA bus motion control cards series.

In addition, we also offer a variety of quick-connect terminal blocks for a range of servo motors, including Mitsubishi, Panasonic, Yaskawa, Delta, etc., which helps customers quickly implement the installation and reduce the potential for using the incorrect wiring.

**Most Cost-Effective**  
**Wide Range Products**  
**Best Service**

**Yaskawa**  
**Mitsubishi**  
**Sanyo Denki**  
**Panasonic**

**Servo Motors**

**Terminal Boards**

**FRnet I/O**

**PISO-PS810**  
 8-axis Motion Control Card  
 ASIC-based, semi-closed loop

**PISO-PS600**  
 6-axis Motion Control Card  
 DSP-based, full-closed loop

**PISO-PS400/PISO-PS410**  
 4-axis Motion Control Card  
 ASIC-based, semi-closed loop

**DN-20M**  
**DN-84100U**  
**DN-8468UB**  
**DN-8368GB/ DN-8368UB**

**FR-2024 series**  
**FR-2017 series**  
**FR-2057 series**  
**FR-2053 series**

## Applications:

- Semiconductor Manufacturing
- Component Inspection
- Manufacturing Quality Control
- Food and Beverage Inspection
- Microscopy and Medical Imaging
- Biometrics Applications
- X-Y-Z Table
- Fix-pitch Stamping Machinery
- Transfer Machinery
- Spinner
- Load/Unload

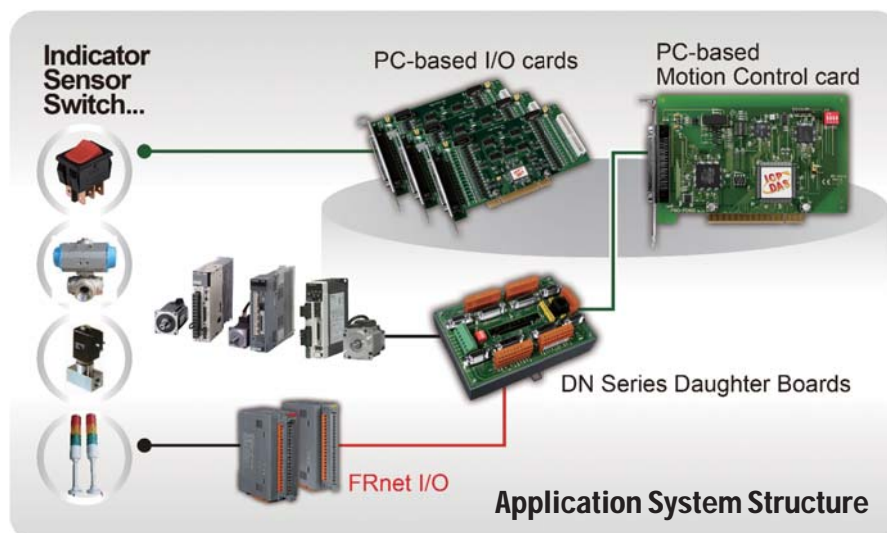

## Selection Guide : PC-based PCI/ISA Bus Motion Control Cards and Terminal Boards

PCI Bus Motion Control Cards	
PISO-PS200	PCI Bus, High-speed 2-axis Motion Control Card with FRnet Master
PISO-PS400	PCI Bus, High-speed 4-axis Motion Control Card with FRnet Master
PISO-PS410	PCI Bus, High-speed 4-axis Motion Control Card with FRnet Master
PISO-PS600	PCI Bus, High-speed, DSP-based, 6-axis Motion Control Card with FRnet Master
PISO-PS810	PCI Bus, High-speed 8-axis Motion Control Card with FRnet Master (Available Soon!)
PISO-ENCODER300U	PCI Bus, 3-axis Encoder Input Card
PISO-ENCODER600U	PCI Bus, 6-axis Encoder Input Card
PISO-PS300U	PCI Bus, 3-axis Stepper Motor/Servo Control Card (Limited Function and Economical)
PMDK	PCI Bus, DSP-based Professional Motion Development Kit
ISA Bus Motion Control Cards	
Encoder300	ISA Bus, 3-axis Encoder Interface Card
STEP-200	ISA Bus, 2-axis High-speed Stepper Motor Control Card (Limited Function and Economical)
SERVO-300	ISA Bus, 3-axis High-speed Servo Motor Control Card (V Command)

Terminal Boards for Machine Automation Products		
	DB-8R	Relay Board for Servo-300 and PISO-PS300U
	DB-200	Encoder Input Board for Servo-300
	DN-68 CR	Encoder Input Board for PISO-ENCODER300U/PISO-ENCODER600U
~New~	DN-20M	Manual-Pulse-Generator (MPG) and FRnet Input Board for PISO-PS600/VS600/PMDK
	<b>DN-8237 Series</b>	<b>Photo-isolated Terminal Board for 2-axis Stepper/Servo Motion Controller</b>
	DN-8237UB	Universal Snap-on Wiring Terminal Board
	DN-8237GB	General Purpose Wiring Terminal Board
	DN-8237MB	Snap-on Wiring Terminal Board for Mitsubishi MELSERVO-J2 Servo Amplifier
	DN-8237PB	Snap-on Wiring Terminal Board for Panasonic MINAS A4/A5 Servo Amplifier
	DN-8237YB	Snap-on Wiring Terminal Board for Yaskawa Sigma II/III/V Servo Amplifier
	DN-8237DB	Snap-on Wiring Terminal Board for Delta ASDA-A Servo Amplifier
~New~	<b>DN-8368 Series</b>	<b>Photo-isolated Terminal Board for PISO-PS600/VS600/PMDK</b>
	DN-8368UB	Universal Snap-on Wiring Terminal Board
	DN-8368GB	General Purpose Wiring Terminal Board
	DN-8368MB	Snap-on Wiring Terminal Board for Mitsubishi MELSERVO-J2 Servo Amplifier
	<b>DN-8468 Series</b>	<b>Photo-isolated Terminal Board for ICP DAS 4-axis Stepper/Servo Motion Controllers</b>
	DN-8468UB	Universal Snap-on Wiring Terminal Board
	DN-8468GB	General Purpose Wiring Terminal Board
	DN-8468MB	Snap-on Wiring Terminal Board for Mitsubishi MELSERVO-J2 Servo Amplifier
	DN-8468PB	Snap-on Wiring Terminal Board for Panasonic MINAS A4/A5 Servo Amplifier
	DN-8468YB	Snap-on Wiring Terminal Board for Yaskawa Sigma II/III/V Servo Amplifier
	DN-8468DB	Snap-on Wiring Terminal Board for Delta ASDA-A Servo Amplifier
	DN-8468FB	Snap-on Wiring Terminal Board for Fuji FALDIC-W Servo Amplifier
~New~	DN-84100U	Universal Snap-on Wiring Terminal Board for PISO-PS410 and PISO-PS810



PAC Solutions

# 5. PAC Solutions - Motion Modules

## Introduction:

As a leading automation solutions provider, ICP DAS provides a wide range of motion solutions for machine automation systems, including PAC solutions that using motion control modules based on the PAC products. There is a variety of development software such as VC, C#, VB .NET or ISaGRAF supporting the PAC Solutions that apply to the PAC motion control systems.



## Selection Guide: Motion Control Modules



Models	Encoder Input				Command Pulse Output				Daughter Board	Other Functions	Supported PAC	Supported Drivers or Software
	Axis	Counter (bits)	Counting Rate (cps)	Signal	Axis	Speed (pps)	Counter (bits)	Signal				
I-8092F-G	2	32	4 M	CW/CCW, A/B	2	4 M	32	CW/CCW, PULSE/DIR	DN-8237	FRnet Master	XP-8000 WP-8000 iP-8000	VC C# VB .NET ISaGRAF (ISaGRAF supports the XPAC ONLY)
I-8094-G	4				4				DN-8468	-		
I-8094F-G					FRnet Master CPU Inside							
I-8094A-G										FRnet Master, CPU Inside		
I-8094H-G												
I-8196F	6	12 M	6	CW/CCW, PULSE/DIR, A/B	DN-8368	FRnet Master	XP-8000					
I-9196F							WP-8000					
										XP-9000		



Note: I-8094A-G, I-8094H-G, I-8196F, and I-9196F do not support ISaGRAF PAC.



Models	Encoder Input					Compare Trigger Output	
	Axis	Counter (bits)	Counting Rate (cps)	Signal	Hardware Latch/Reset	Channel	Type
I-8093W	3	32	4 M (CW/CCW, Pulse/Dir) 1 M (A/B)	CW/CCW, PULSE/DIR, A/B	-	-	-
I-9093	3		6 M (CW/CCW, Pulse/Dir) 2 M (A/B)		3	3	Open collector



Note: I-9093 do not support ISaGRAF PAC.

## Selection Guide: PAC

XP-9000 and WP-9000 Series		OS	CPU	Flash	SDRAM	VGA Resolution	Ethernet	Serial	I/O Slot
XP-9171-WES7		WES7	E3827 1.75 GHz dual core	32 GB	DDR3 × 2 GB	1920 × 1080	2	4	1
XP-9371-WES7									3
XP-9771-WES7									7
XP-9181-WES7		WES7	E3845 1.91 GHz quad core	32 GB	DDR3 × 4 GB	1920 × 1080	2	4	1
XP-9381-WES7									3
XP-9781-WES7									7
WP-9221-CE7		CE 7.0	Cortex-A8, 1.0 GHz	256 MB	DDR3 × 512 MB	1024 × 768	2	4	2
WP-9421-CE7									4
WP-9821-CE7									8

XP-8000 Series XPAC		OS	CPU	Flash	SDRAM	VGA Resolution	Ethernet	Serial	I/O Slot
XP-8131-WES7		WES7	x86 CPU, 1 GHz, dual-core	32 GB	DDR3 × 2 GB	1600 × 1200	2	4	1
XP-8331-WES7									3
XP-8731-WES7									7
XP-8131-CE6		CE 6.0	x86 CPU, 1 GHz, dual-core	32 GB	DDR3 × 2 GB	1024 × 768	2	4	1
XP-8331-CE6									3
XP-8731-CE6									7

WP-8000 Series WinPAC		OS	CPU	Flash	SDRAM	VGA Resolution	Ethernet	Serial	I/O Slot
WP-8121-CE7		CE 7.0	Cortex-A8, 1.0 GHz	512 MB DDR3	512 MB DDR3	1024 × 768	2	4	1
WP-8421-CE7									4
WP-8821-CE7									8
WP-8141		CE 5.0	PXA270, 520 MHz	96 MB	128 MB	800 × 600	2	4	1
WP-8441									4
WP-8841									8

iP-8000 Series iPAC		OS	CPU	Flash	SRAM	Expansion Memory	Ethernet	Serial	I/O Slot	
iP-8411		MiniOS7	80186, 80 MHz	512 KB	512 KB	microSD	-	4	4	
iP-8811									8	
iP-8441					768 KB	microSD	2		4	4
iP-8841										8

# 6. Features of Motion Function

## 1. Linear Interpolation

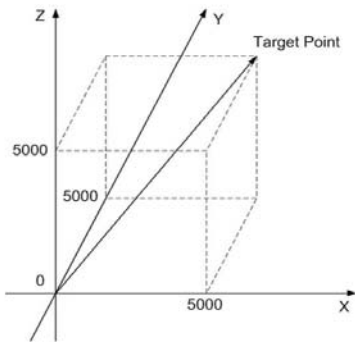

## 2. Circular Interpolation

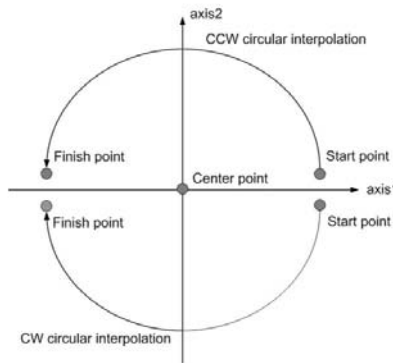

## 3. Continuous Interpolation

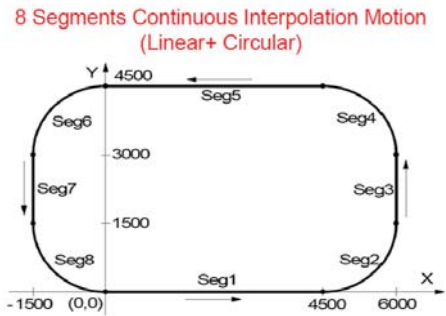

## 4. Four Steps Automatic Home Searching

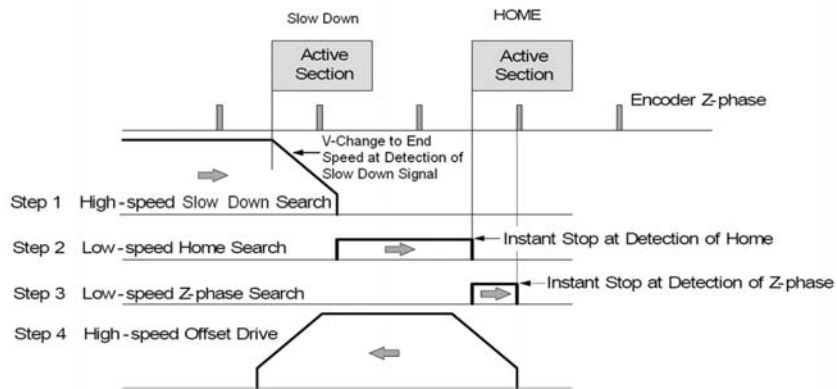

## 5. High Speed Position Compare

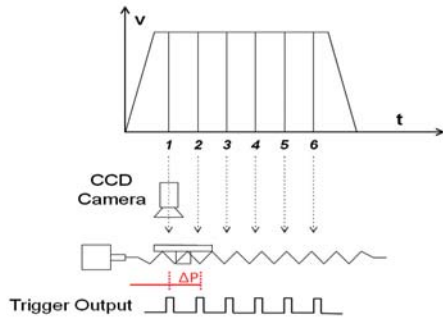

## 6. Huge Command Buffer and Real Time Coordinate Transformation Suitable for Robotic Control



Motion Products	Features of Motion Functions					
Model	1. Linear Interpolation	2. Circular Interpolation	3. Continuous Interpolation	4. Four Steps Automatic Home Searching	5. High Speed Position Compare	6. Huge Command Buffer and Real Time Coordinate Transformation Suitable for Robotic Control
<b>PC-based Motion Control Cards</b>						
PISO-PS200	2-axis	2-axis	Constant Vector Speed	Yes	-	-
PISO-PS400	3-axis				-	-
PISO-PS410		6-axis	3-axis	With Acc. and Dec.	Yes	Yes
PISO-PS600	2 Groups 3-axis	2 Groups 2-axis	Constant Vector Speed	Yes	-	-
PISO-PS810	<b>Motion Control Modules for PAC</b>					
I-8092F	2-axis	2-axis	Constant Vector Speed	Yes	-	-
I-8094/I-8094F	3-axis				Yes	-
I-8196F/9196F	6-axis	3-axis	With Acc. and Dec.	Yes	Yes	Yes



# Energy Management Solution

# 8

1	Energy Management Solution	P 8-1
2	Power Meter Concentrator	P 8-2
3	Smart Power Meter & Devices	P 8-6
4	Software Utility	P 8-7

- Power Meter Concentrator - - - - - P 8-8
- Power Meter Concentrator With Display- - - - - P 8-9
- Three-phase Smart Power Meter
  - ▶ PM-3133-RCT/-MTCP/-CPS- - - - - P 8-10
  - ▶ PM-3133/-MTCP/-CPS - - - - - P 8-12
  - ▶ PM-3033/-MTCP/-CPS - - - - - P 8-14
- Single-phase Smart Power Meter - - - - - P 8-16
- Multi-circuit Smart Power Meter- - - - - P 8-18
- 8-channel True RMS Input Module - - - - - P 8-21
- Industrial Multi-power-meter Display - - - - - P 8-23



### Energy Management Solutions - EM Brochure

- True RMS Input Module
- TouchPAD - VPD series
- Smart Power Meter
- Smart Power Meter Concentrator
- Power Data Management Software

Or refer to <http://www.icpdas.com/root/support/catalog/pdf/Brochure/EM-Brochure-en.pdf>

# 1. Energy Management Solution

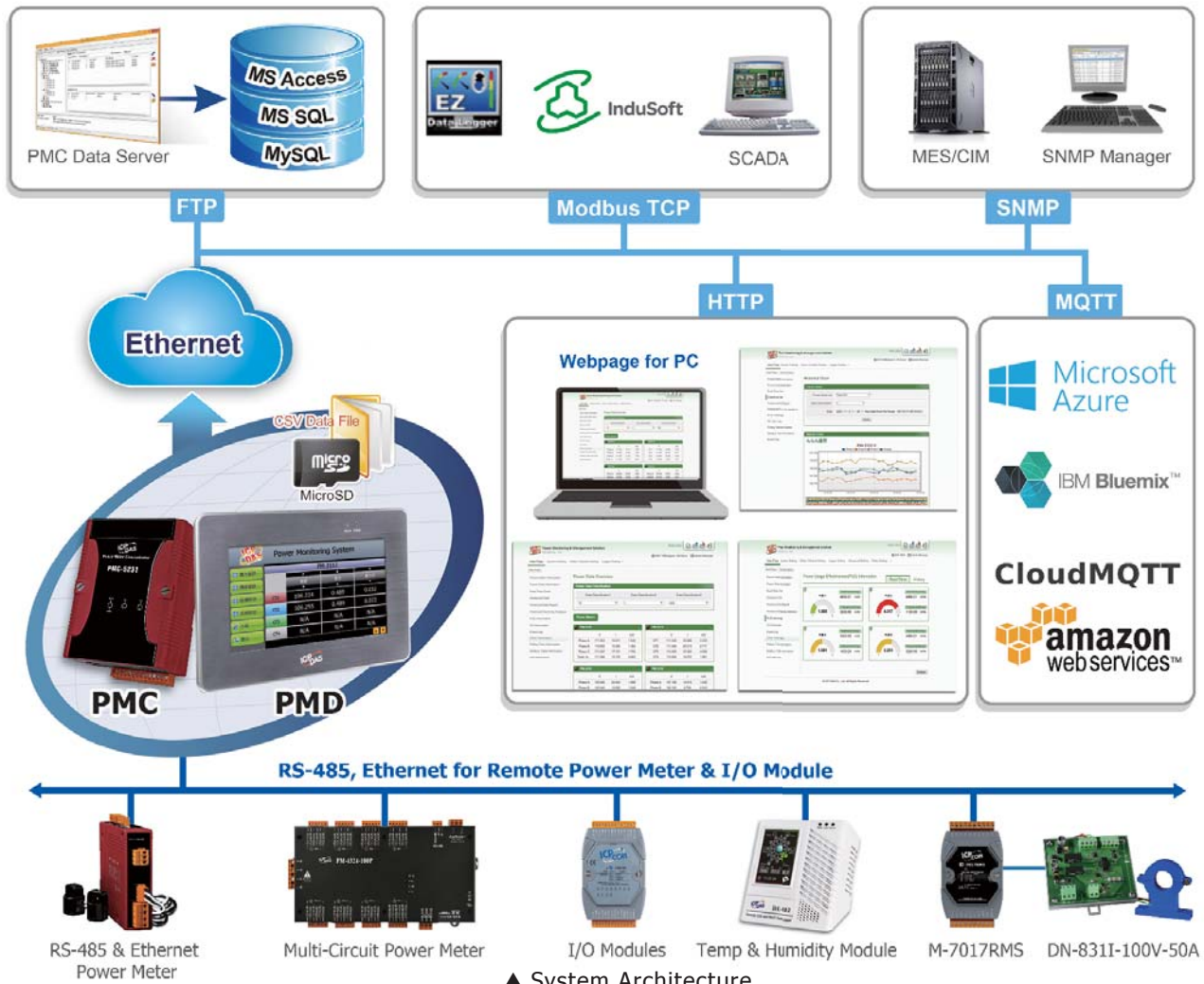

▲ System Architecture

For the resources of the earth are getting depleted faster in recent years, countries around the world and all walks of life all set off a wave of energy saving and carbon reduction in order to avoid the waste of resources and pursue living a sustainable life to extend earth's resources. Under the trend of energy saving and carbon reduction, power monitoring gradually becomes an important project for maximizing energy efficiency by power monitoring always contributing to significant energy savings no matter on the individual, corporate or national level. In order to achieve more efficient use of energy and reduce resources consumption, ICP DAS provides an innovative total solution in energy saving by connecting PMC/PMD (Power Meter Concentrator) to the Power Meters via RS-485 or Ethernet interface, it can measure and monitor the power consumption of the devices, machines, lighting, air conditioning or other electricity equipments. In addition, PMC/PMD also provides power demand management and alarm notification functions. With the integration of ICP DAS I/O modules and the standard Modbus I/O devices, it can perform logic control or load shedding of the devices based on the power demand in real time. PMC/PMD also supports various communication protocols as Modbus, SNMP, MQTT for seamless integration with the back-end SCADA/MES/IT/IoT systems. So that the administrator can monitor the status of power consumption of each device and perform statistics and analysis of the power information, thus improving the overall efficiency in electricity consumption to save costs on utility bills.

This innovative total solution for energy saving includes: front-end Smart Power Meter, Power Meter Concentrator, back-end software tool for database import operation (PMC Data Server) and InduSoft SCADA software. In addition to hardware devices, ICP DAS also provides total solution so that the user could easily view power data by their mobile phones or PC, the administrator could set up the system quickly and the data can be recorded in real time for energy consumption inquiry to achieve effective energy saving. During the early stage, if the scale of the application is small, the user could simply use Smart Power Meter and PMC/PMD to set up a simple power monitoring system, once the scale of the application is expanded, the user could get the back-end software tool involved and build an easy-to-expand power monitoring system via blocks stacked structure. By this way, the system will be highly flexible and could be implemented in phases to meet various requirements.

# 2. Power Meter Concentrator

## PMC/PMD Features:

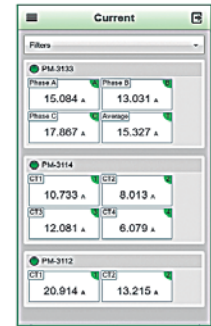
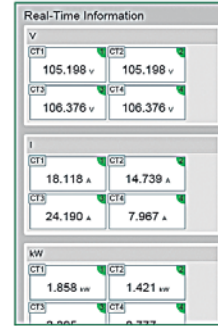

### No extra software tool, using browsers to perform system operations

Featuring web-based HMI for easy operations, the user could connect to PMC/PMD webpage via browsers to view the power data, set up system parameters, manage power demand and perform logic editing function for alarm notification.

### Built-in Micro SD card for power data logging

The PMC/PMD features a built-in Micro SD card. After the PMC/PMD retrieving the power data from the power meter, the system will save the power data in CSV format in the Micro SD card and regularly send back the data files to the backend management center for data analysis and statistics.

### Display real-time or historical power data trend

In addition to display power data of the power meter in text form, the power data can also be displayed in real-time and historical trend chart for user to easily identify the variation of the electricity usage of the devices.

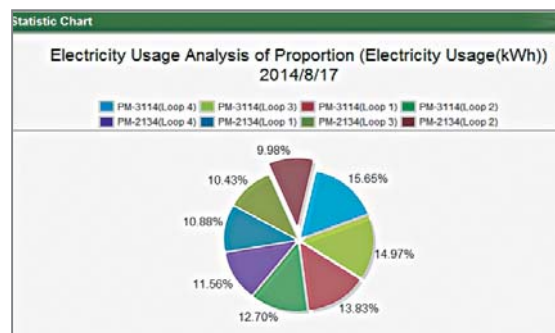
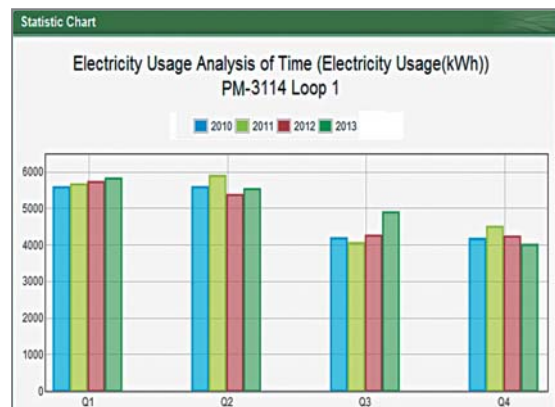
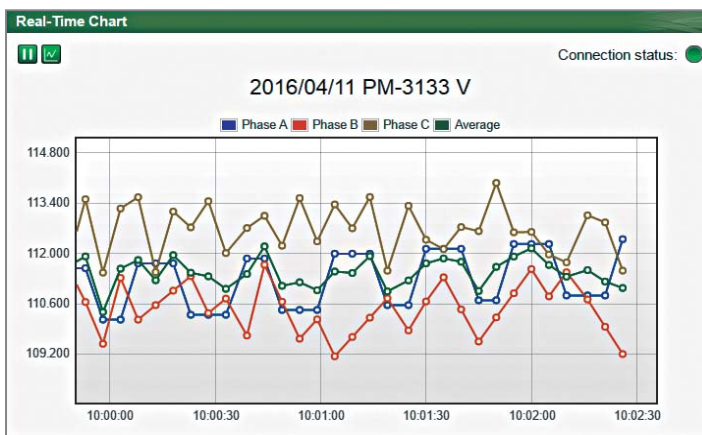

### FTP Server/Client for data file management and file recovery mechanism supported

The built-in FTP Client function of PMC/PMD allows regular transmission of the power data logger files saved in the Micro SD card of PMC/PMD to the backend management center for data analysis and statistics. The PMC/PMD offers a complete data file recovery mechanism so that when experiencing network disconnection, the data log files will be recovered after the network is resumed to ensure the system operates properly. With the FTP Server of PMC/PMD, the user could also use FTP Client utility to retrieve the power data files saved in PMC/PMD from the PC side easily.



### ■ Built-in IF-THEN-ELSE logic engine for thought-out power demand management and auto alarm notification when unusual events occurs

PMC/PMD is equipped with IF-THEN-ELSE logic engine. The user could complete the control logic via web page and download the logic rules to the PMC/PMD. The logic engine will loop execute the rules in order. By editing the IF-THEN-ELSE logic rules, the user could include the following information in the IF condition, such as: "fail to connect to power meter", "FTP upload failed", "insufficient disk space", "power demand management", "abnormal power data", etc. In addition, the Schedule setting and channel values of I/O modules that are connected to the PMC/PMD can be also included in the IF condition. When the evaluation of the IF condition is matched, the corresponding Action will be executed (such as: Email/SMS alarm message sending or AO/DO channel value of the I/O modules setting). By this way, the user could quickly implement applications for power demand management, electricity control of the devices and alarm notification sending.

**Rule Overview**

Rule 1  
 < IF >  
 COM2 PM-3112(3:Room3) CT1 Actual Demand < 30  
 < THEN >  
 COM2 PM-3112(3:Room3) DO0 = ON (One Time)  
 < ELSE >  
 COM2 PM-3112(3:Room3) DO0 = OFF (One Time)

Rule 2  
 < IF >  
 COM2 PM-3114(4:Room4) CT1 kW > 30  
 < THEN >  
 COM2 PM-3114(4:Room4) DO0 = ON (One Time)  
 < ELSE >  
 COM2 PM-3114(4:Room4) DO0 = OFF (One Time)

**Rule Content Setting**

**IF** Add a new Condition: Set a Condition  
 Power Meter Basic Values  
 Connection Status Statistical Values  
 SD Card Status Other Information

**THEN** Add a new Action: Set an Action  
 Actual Demand  
 Forecast Demand  
 Hourly Maximum Demand  
 Daily Maximum Demand  
 Monthly Maximum Demand  
 Daily Accumulated Electricity  
 Monthly Accumulated Electricity  
 Yearly Accumulated Electricity

**ELSE** Add a new Action: Set an Action  
 COM2 PM-3112(3:Room3) DO0 = OFF

### ■ Provide Schedule function

PMC/PMD provides Schedule function that allows to edit logic for applications that requires Schedule function. The Calendar interface allows to easily set up the schedule for weekdays or weekends so that the user could schedule the operations for the devices as required for power saving.

**Schedule Content Setting**

Mode:  Calendar  Repeat

Date: Starting Month: 2013 November  
 Duration: 3 Month(s)

\*Time Range(s): 08:00:00 ~ 17:00:00

Select All Unselect All Select Weekday Select Weekend In Range Out of Range

2013 / 11							2013 / 12							2014 / 1						
Sun	Mon	Tue	Wed	Thu	Fri	Sat	Sun	Mon	Tue	Wed	Thu	Fri	Sat	Sun	Mon	Tue	Wed	Thu	Fri	Sat
					1	2	1	2	3	4	5	6	7				1	2	3	4
3	4	5	6	7	8	9	8	9	10	11	12	13	14	5	6	7	8	9	10	11
10	11	12	13	14	15	16	15	16	17	18	19	20	21	12	13	14	15	16	17	18
17	18	19	20	21	22	23	22	23	24	25	26	27	28	19	20	21	22	23	24	25
24	25	26	27	28	29	30	29	30	31					26	27	28	29	30	31	

### ■ Provide historical power data statistics report

PMC/PMD provides historical data report inquiry and display function, the easy-to-read daily and monthly report of the historical power data would help to understand current electricity usage of the devices.

Report Date: 2015-08 Central Air Conditioning - Monthly Report Print Date: 2015-11-11

Day	Max. Demand(kW)	kWh(kWh)	Arg. PF(%)	Lc(A)	Lk(A)	Lc(A)	V <sub>LN</sub> (V)	V <sub>LN</sub> (V)	V <sub>LN</sub> (V)	kVA Tot.(kVA)	Accr Tot.(kwh)
1	4.934	117.189	94.2	15.495	13.494	17.494	111.497	110.497	112.506	5.183	1.72
2	4.934	117.223	94.3	15.499	13.493	17.495	111.499	110.51	112.495	5.183	1.718
3	4.931	117.219	94.3	15.499	13.495	17.493	111.499	110.505	112.499	5.183	1.716
4	4.931	117.188	94.3	15.499	13.495	17.494	111.503	110.498	112.492	5.183	1.719
7	4.93	117.213	94.3	15.499	13.494	17.494	111.5	110.506	112.501	5.183	1.719
8	4.934	117.189	94.2	15.499	13.496	17.494	111.494	110.493	112.498	5.183	1.72
9	4.935	117.207	94.3	15.498	13.494	17.493	111.498	110.496	112.501	5.183	1.718
24	4.93	117.215	94.3	15.498	13.493	17.494	111.495	110.502	112.498	5.183	1.718
25	4.931	117.211	94.3	15.499	13.493	17.494	111.498	110.514	112.49	5.183	1.719
26	4.931	117.197	94.2	15.498	13.494	17.493	111.496	110.511	112.5	5.183	1.72
27	4.931	117.213	94.3	15.499	13.494	17.495	111.498	110.519	112.5	5.184	1.718
28	4.93	117.203	94.3	15.499	13.495	17.494	111.5	110.494	112.5	5.183	1.719
31	4.93	117.221	94.3	15.498	13.493	17.491	111.493	110.494	112.495	5.183	1.716
30	4.943	117.211	94.3	15.499	13.493	17.495	111.499	110.5	112.512	5.183	1.718
31	4.936	117.211	94.3	15.499	13.495	17.494	111.499	110.501	112.5	5.183	1.718
Total Electricity		3633.401 kWh		Monthly Highest Usage		5.625 kW		Occurrence Time		2015/8/14 10:14	

### ■ Modbus TCP/RTU for seamless integration with SCADA

The PMC/PMD supports Modbus TCP/RTU Slave protocol to connect to SCADA software or HMI devices in control center so that it could perform real-time monitoring and control of the electricity usage for the devices. Therefore, the regulation of the system will be more flexible.

### ■ Provide Timer Function

Timer function provides Timeout/Not Timeout status for condition evaluations. With the timer function, the users are able to edit logic that requires timing approach. In addition, the timer function can be reset/started in real time that increases flexibility when performing logic control.

## Support a variety of wide-range I/O modules to achieve power control and load shedding of the devices

According to the requirements of the application and based on the devices connected, the PMC/PMD is able to connect to M-7000 I/O modules, standard Modbus TCP/RTU Slave modules or DO Relay channel of the PM Series power meter for real time I/O control operation of the devices, the abundant selections enable maximum flexibility for system set up and power saving.

Meter / Module Setting Page

XW-Board

None

COM2 | Modbus RTU Master

No.	Module Name / Nickname	Address	Polling Timeout(ms)
1	ICP DAS PM-3133(Room1)	1	1000
2	ICP DAS PM-3133(Room2)	2	1000
3	ICP DAS PM-3112(Room3)	3	1000
4	ICP DAS PM-3114(Room4)	4	1000
5	M-7018Z(Temp. Monitor)	5	300
6	M-7060(Power Control)	6	300

I/O Information

Options: M-7060(6:Power Control)

DI

Ch.0	Ch.1	Ch.2	Ch.3
OFF	OFF	OFF	OFF
Counter: 0	Counter: 0	Counter: 0	Counter: 0

DO

Ch.0	Ch.1	Ch.2	Ch.3
OFF	OFF	OFF	OFF

I/O Information

Options: M-7018Z(5:Temp. Monitor)

AI

Ch.0	Ch.1	Ch.2	Ch.3	Ch.4
0.000 °C	0.000 °C	0.000 °C	0.000 °C	0.000 °C

Ch.5	Ch.6	Ch.7	Ch.8	Ch.9
0.000 °C	0.000 °C	0.000 °C	0.000 °C	0.000 °C

## On-Site Power data viewing and Power Meter setting

PMD (Power Meter Concentrator with Display) series is equipped with TFT LCD (with Touch Panel). It provides an easy way for viewing the power data and set up the Power Meter parameters on sites.



## Support SNMP Function

In addition to Modbus protocol, PMC/PMD also supports SNMP function that allows seamless integration with IT Management software. The users could integrate PMC/PMD with the existing management system and collect the power data of each device by SNMP function easily.

## Provide "Power Usage Effectiveness (PUE)" calculation operation

Power usage effectiveness (PUE) is a measure of how efficiently a computer data center uses energy; specifically, how much energy is used by the computing equipment (in contrast to cooling and other overhead). PUE is the ratio of total amount of energy used by a computer data center facility to the energy delivered to computing equipment. The PUE will be greater than 1. The larger the PUE number the less efficient your utilization is. PMC/PMD provides the PUE calculation operation and also display the PUE data in two modes (Real-Time and History) through Web page.

Power Usage Effectiveness(PUE) Information

Real-Time History

<p>1</p> <p>PUE 1</p> <p>Total Facility Energy: 4856.21 kWh</p> <p>IT Equipment Energy: 2101.92 kWh</p> <p>2.310</p>	<p>4</p> <p>PUE 4</p> <p>Total Facility Energy: 4856.21 kWh</p> <p>IT Equipment Energy: 1125.00 kWh</p> <p>4.317</p>
<p>7</p> <p>PUE 7</p> <p>Total Facility Energy: 3226.92 kWh</p> <p>IT Equipment Energy: 1629.29 kWh</p> <p>1.981</p>	<p>10</p> <p>PUE 10</p> <p>Total Facility Energy: 4856.21 kWh</p> <p>IT Equipment Energy: 3226.92 kWh</p> <p>1.505</p>



**A variety of protocols supported - a cost-effective power meter concentrator in the IoT age**

PMC/PMD supports various communication protocols to perform real-time energy monitoring and control of the controllers. The Modbus TCP/RTU protocol of PMC/PMD allows sharing power data and system information with the SCADA system. PMC/PMD also support the SNMP, FTP and MQTT protocols for easy integration with the IT/IoT/Facility management system. The flexible integration ability with the SCADA/IT/IoT system makes PMC/PMD the most cost-effective power meter concentrator in the Energy management application of IoT age.

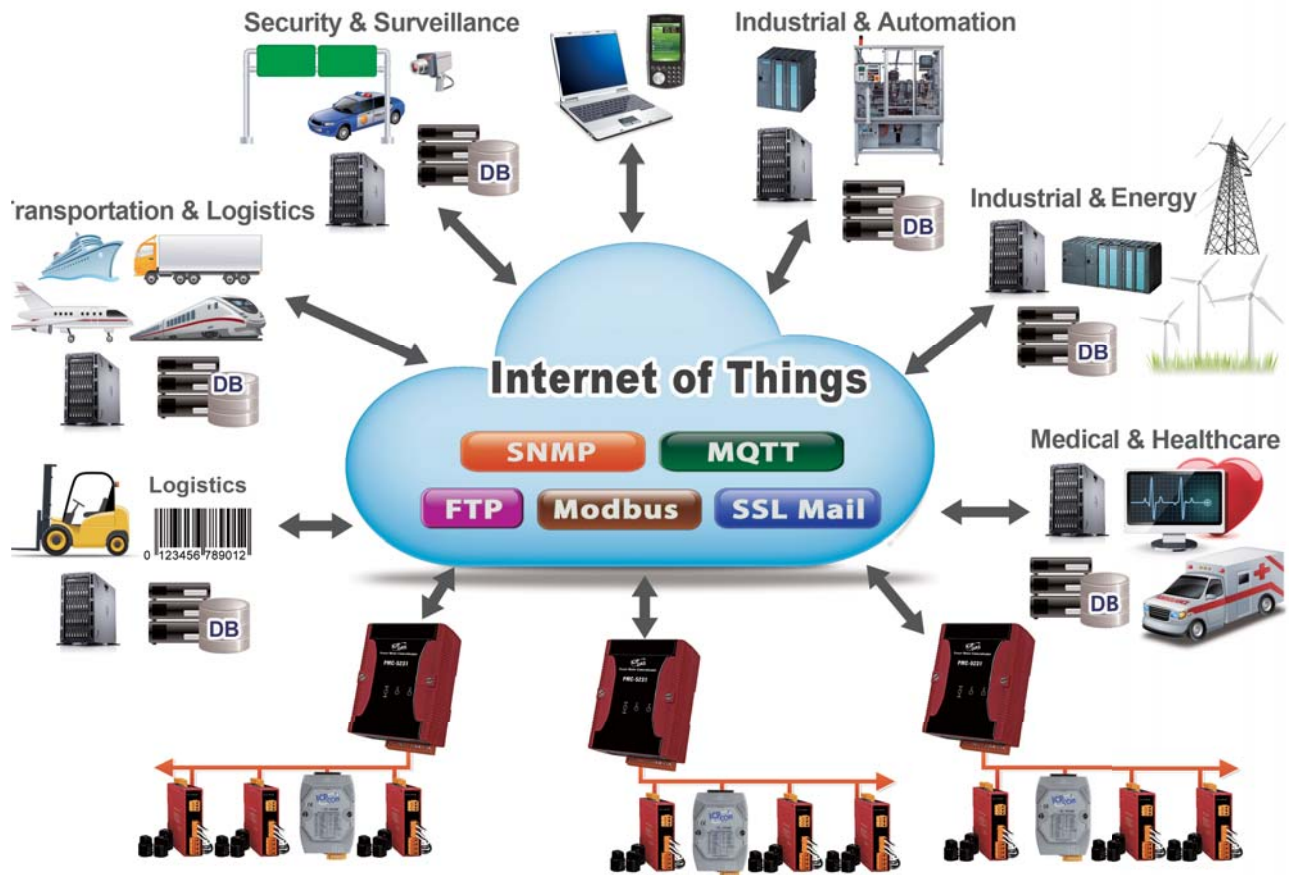

**3G Wireless data communication & SMS message operation (for PMC-5231M-3GWA only)**

In addition to Ethernet interface, PMC-5231M-3GWA provides 3G Wireless communication interface. It can send the real-time power data, data log files and Email alarm message back to the control center by 3G Wireless Network. PMC-5231M-3GWA also supports SMS message sending function for real-time message notification. The message sending action can be added to the logic rule as part of logic control to provide real-time message notification to the related personnel when an event occurs. PMC is also equipped with SMS command receiving function. It allows to receive the SMS commands sent by specific phone numbers to perform tasks such as real-time power data monitoring, I/O channel value modification and logic rules execution (triggered by SMS), etc.





# 3. Smart Power Meter & Devices

## PM Smart Power Meter Features

- Provide multi-phase multi-circuit power measurement function

PM-3033: 1 Three Phase Circuit

PM-3133: 1 Three Phase Circuit

PM-3112: 2 Single Phase Circuits

PM-3114: 4 Single Phase Circuits

PM-4324: 8 Three Phase Circuits or 24 Single Phase Circuits

- Support multiple communication interfaces:

- RS-485
- Ethernet
- CANopen

- Support multiple standard communication protocols:

- Modbus RTU
- Modbus TCP
- CANopen

- Support 2 built-in Power Relay Output

- With CT W Accuracy Better than 0.5% (PF=1)

- Clip on CT for easy installation

- Compact size, easy to install, suitable for a variety of industrial applications



## True RMS Input Module Features

M-7017RMS



Modbus RTU  
DCON

- 8-channel True RMS Input
- ±0.15% Factory Calibrated Accuracy
- RMS Input Range: +150 mVrms ~ +10 Vrms
- For Standard Operation with Frequencies: 45 Hz ~ 10 KHz
- Individual Channel Configurable
- 4 kV ESD Protection
- ±35 VDC Overvoltage Protection
- 2500 VDC Intra-module Isolation

## Industrial Multi-power-meter Display

7" Series



4.3" Series



Modbus TCP  
Modbus RTU

- Built-in HMI for Information Display of Power Meters
- IP40/IP60 Ingress Protection for Front Panel
- Support Modbus TCP/RTU Protocols
- Support Max. of 8 Single-phase/3-phase Power Meters (PM-3xxx series) or One PM-4324
- Support Max. of 4 Modbus/TCP Connections for SCADA Software
- Support Phase Sequence Detection
- Support Fine Tune of Voltage and Current Ratio

# 4. Software Utility

**PMC Data Server**

The PMC Data Server is a database utility designed for connecting to the PMC/PMD concentrators. When PMC/PMD Data Server is connected to these PMC/PMDs by Ethernet, the PMC/PMDs will send the power data logger files to the PMC Data Server at scheduled time, and these power data will be transformed to MS Access/MS SQL/MySQL database format for easy data review or inquiry. During the whole process of system development, no programming is required. It takes only a few settings for users to quickly retrieve and view the power data of the devices based on database system and furthermore, enables further process of the data for statistics and analysis.

## Power Meter Utility

Power Meter Utility has to be installed on PC and it enables to retrieve and display the power measurement values that measured by power meter via COM Port or Ethernet. The users will be able to read the power measurement values and to perform parameter settings of the meter. When connecting with ICP DAS power meters by RS-485 communication protocol interface, it requires to convert RS-232 or USB on PC to RS-485 communication interface, converter modules (such as ICP DAS I-7561, I-7520) might be required; When connecting with ICP DAS power meters by Ethernet interface, it must setup the correct IP address to retrieve the power measurement values easily.

**Features:**

- By Modbus RTU or Modbus TCP protocol, it enables to connect with ICP DAS Power Meters and data retrieving.
- Real time monitor power measurement values of the meter.
- Real time setting up parameters of the meter.
- Restore the parameters of the meter to default settings.
- Support Data Log function

Channel	Voltage	Current	kW	kvarh	kVA
Channel 1:	109.60900	1.00266	0.09127	0.00811	0.09173
Channel 2:	109.60990	1.00024	0.09132	0.00818	0.09169
Channel 3:	109.66820	1.00258	0.09127	0.00943	0.09176
Channel 4:	109.66820	1.00461	0.09117	0.00946	0.09166

# Power Meter Concentrator



## Features:

- No extra software tool is required, using browsers to perform system operations
- Support at most 24 ICP DAS Modbus Power Meter and 8 Modbus I/O modules
- Display real-time or historical power data (in data table or chart form)
- Provide power data statistics report (Daily and Monthly report)
- Data file auto send-back & recovery when network is resumed after disconnection
- Built-in IF-THEN-ELSE logic engine for thought-out power demand management
- Provide alarm message notification function via Email
- Adjust device operations by its power status via Modbus I/O modules
- Provide Schedule function for operations of I/O modules (devices)
- Support Modbus TCP/RTU Slave protocol for seamless integration with SCADA
- Support SNMP and MQTT protocols
- Support Connection with IoT Cloud Platform (Microsoft Azure and IBM Bluemix)
- PMC-5231M-4GE/PMC-5231M-3GWA supports 4G/3G Wireless data communication
- PMC-2241 support 2 × LANs and an optional 4G LTE modem

## Introduction:

PMC-5231/2241 is the new generation of Power Meter Concentrator for meeting the trend of energy saving and carbon reduction in the Industry 4.0 age. It provides flexible integration with the ICP DAS power meters via RS-485 or Ethernet interface, and features various functions such as: measure the power consumption of the devices, energy usage analysis, power demand management and alarm notification functions. The PMC-5231/2241 features a built-in Micro SD card. After it retrieving the power data from the power meter, it will save the power data in data log file, and automatically send back the data log files to the back-end management center for data analysis and statistics.

PMC-5231/2241 offers a user-friendly and intuitive web site interface that allows users to implement the Energy monitoring and management system just a few clicks away; no programming is required. In addition to ICP DAS XV-Board and M-7000 I/O modules, the PMC-5231/2241 can also connect to standard Modbus TCP/RTU Slave modules. By working with the I/O modules, and functions such as IF-THEN-ELSE logic rule execution and alarm notification functions including Email/SNMP Trap, PMC-5231/2241 offers more thought-out power demand management and alarm notification functions, and is able to perform load shedding of the devices if required, and enables real-time monitoring and control of the power consumption of the devices.

PMC-5231/2241 also supports the Modbus TCP/RTU, SNMP, FTP and MQTT protocols for seamless integration with the back-end SCADA/MES/IT/IoT/Network Management systems. So that the administrator can monitor the status of power consumption of each device and perform statistics and analysis of the power information, thus improving the overall efficiency in electricity consumption to save costs on utility bills.

## Specifications:

Models	PMC-5231 Series	PMC-2241 Series
<b>System</b>		
Software	PMC Runtime, Web server, FTP server	
microSD Expansion	Built-in one 4 GB microSD card (support up to 32 GB microSDHC card)	
<b>Communication</b>		
Ethernet	RJ-45 × 1, 10/100/1000 Base-TX	RJ-45 × 2, 10/100/1000 Base-TX
COM 2	RS-232 (Tx/D, Rx/D, GND), non-isolated, Speed: 115200 bps max.	
COM 3/COM 4	RS-485 (Data+, Data-), Speed: 115200 bps max. COM 4 provides 2500 VDC isolation	
<b>Power Requirements</b>		
Input Range	12 to 48 VDC	
Power Consumption	4.8 W (PMC-5231, PMC-2241); 6.5W (PMC-5231M-3GWA, PMC-5231M-4GE, PMC-2241-4GE)	
<b>Mechanical</b>		
Dimensions (W × L × H) Installation	<b>PMC-5231:</b> 91 mm × 132 mm × 52 mm / DIN-Rail Installation <b>PMC-5231M-3GWA/PMC-5231M-4GE:</b> 117 mm × 126 mm × 58 mm / Wall Mounting Installation	<b>PMC-2241:</b> 33 mm × 160 mm × 129mm / DIN-Rail Installation <b>PMC-2241-4GE:</b> 33 mm × 160 mm × 129mm / DIN-Rail Installation
<b>Environmental</b>		
Temperature	Operating Temperature: -25°C to +75°C; Storage Temperature: -40°C to +80°C	
Humidity	10 to 90% RH, Non-condensing	
<b>3G System (PMC-5231M-3GWA · PMC-5231M-4GE · PMC-2241-4GE)</b>		
Frequency Band	<b>PMC-5231M-3GWA:</b> WCDMA 850/900/1900/2100 MHz; WCDMA / HSPA+ <b>PMC-5231M-4GE/PMC-2241-4GE:</b> WCDMA 850/900/2100; DC-HSPA+; TD-SCDMA ; CDMA2000 EVDO.	
<b>4G LTE (PMC-5231M-4GE · PMC-2241-4GE)</b>		
Frequency Band	LTE FDD: B1/B3/B5/B7/B8/B20; LTE TDD: B38/B40/B41	



# Power Meter Concentrator With Display



**10.4" TFT LCD**    **7" TFT LCD**  
**PMD-4201**    **PMD-2201**

## Features:



- No extra software tool is required, using browsers to perform system operations
- Support at most 24 ICP DAS Modbus Power Meter and 8 Modbus I/O modules
- 7"/10.4" TFT LCD (with Touch Panel) & PoE (Power over Ethernet) supported
- Display real-time or historical power data by browser or local display
- Provide power data statistics report by browser
- Data file auto send-back & recovery when network is resumed after disconnection
- Built-in IF-THEN-ELSE logic engine for thought-out power demand management
- Provide alarm message notification function via Email or SMS (Refer to ICP DAS related product for SMS message sending.)
- Adjust device operations by its power status via Modbus I/O modules
- Provide Schedule and Timer function for operations of I/O modules (devices)
- Support Modbus TCP/RTU Slave protocol for seamless integration with SCADA
- Support SNMP and MQTT protocols
- Support Connection with IoT Cloud Platform (Microsoft Azure and IBM Bluemix)

## Introduction:

PMD is equipped with the TFT LCD (with Touch Panel) and designed for panel mount installation. It provides an easy way for viewing the power data and setting the system parameters at the local side. PMD also is equipped with built-in Web Server that allows direct connections via browsers to the PMD for viewing power data and setting the system parameters. PMD also supports the Modbus TCP/RTU, SNMP, FTP and MQTT protocols for seamless integration with the back-end SCADA/MES/IT/IoT/Network Management systems.

In addition to ICP DAS M-7000 I/O modules, the PMD could connect to standard Modbus TCP/RTU Slave modules. By working with the I/O modules, and functions such as IF-THEN-ELSE logic rule execution and alarm notification functions including Email/SNMP Trap, PMD offers more thought-out power demand management and alarm notification functions, and is able to perform load shedding of the devices if required, and enables real-time monitoring and control of the power consumption of the devices.

When using PMD to build a power management and monitoring system, during the whole process of system development, no programming is required; it takes a few clicks on web page to complete all settings; it is easy for the user to quickly view the power data of the devices and furthermore process the data for statistics and analysis. The PMD is an easy-to-use and easy-to-build total solution for power management and monitoring that makes more efficient energy usage.

## Specifications:

Models	PMD-2201	PMD-4201
<b>System Software</b>		
Embedded Service	PMC Runtime, Web server, FTP server	
<b>CPU Module</b>		
CPU	32-bit ARM CPU (720MHz)	32-bit ARM CPU (1GHz)
DRAM	512 MB	
Flash (SSD)	256 MB	
Memory Expansion	microSD socket with 4 GB micro SDHC card (support up to 32 GB)	SD socket with 4 GB SDHC card (support up to 32 GB)
LED Indicator	2 LEDs for Power and Running (Run, PWR)	
Rotary Switch	Yes (0 to 9)	
<b>LCD</b>		
Diagonal Size	7" (16:9)	10.4" (4:3)
Resolution	800 × 480	800 × 600
Brightness (cd/m2)	400	
Contrast Ratio	500:1	
LED Backlight Life (hrs)	20,000	50,000
Touch Panel	4-wire, resistive type; light transmission: 80%	5-wire, resistive type; light transmission: 80%

Models	PMD-2201	PMD-4201
<b>Communication Ports</b>		
Ethernet	1 × RJ-45 10/100/1000 Base-TX	
USB 2.0 (host)	2	
COM 1	RS-485 (Data+, Data-) (9-wire DB9 connector); 2500 VDC isolated	
COM 2	RS-485 (Data+, Data-) (9-wire DB9 connector); 2500 VDC isolated	
COM 3	-	RS-485 (Data+, Data-, GND); 2500 VDC isolated
<b>Mechanical</b>		
Dimensions (W × H × D)	213 mm × 148 mm × 44 mm	291 mm × 229 mm × 54 mm
Panel Cut-Out (W × H)	197 mm × 133 mm, ±1 mm	277 mm × 215 mm, ±1 mm
Installation	Panel Mounting	
Ingress Protection	Front panel: NEMA 4/IP65	
<b>Environmental</b>		
Operating Temperature	-10°C ~ +60°C	
Storage Temperature	-20°C ~ +70°C	
Ambient Relative Humidity	10 ~ 90% RH (non-condensing)	
<b>Power</b>		
Input Range	+12VDC to +48 VDC	
Power from PoE	IEEE 802.3af	
Consumption	6W	13W

# Three-phase Smart Power Meter

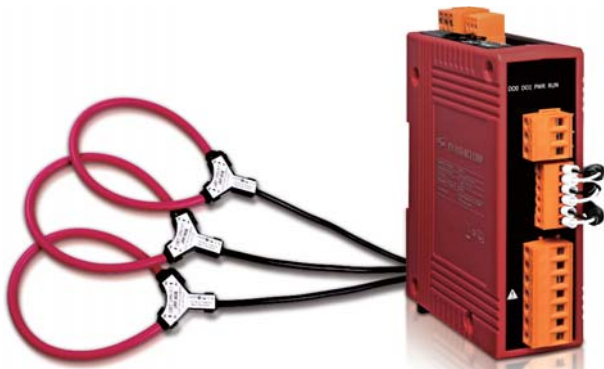

**PM-3133-RCT/-MTCP/-CPS**



## Features:

- True RMS Power Measurements
- Energy Analysis for 3P4W, 3P3W, 1P3W, 1P2W
- Current Measurements Up to 2000 A
- Voltage Measurements Up to 500 V
- Rogowski Coil Soft CT for Easy Installation
- W Accuracy Better than 1% (PF=1; Input Current >50A)
- Supports RS-485, Ethernet (PoE) or CANopen Interface
- Supports Modbus RTU, Modbus TCP or CANopen Protocol
- Supports 2 Power Relay Output (Form A)
- Total Harmonic Distortion (THD)
- Multiple Data Format

## Introduction:

ICP DAS brings the most powerful, cost-effective, advanced Smart Power Meters PM-3133-RCT that gives you access to real-time electric usage for three-phase power measurement. With its high accuracy (<1%, PF=1; Input Current >50A), this series can be used to both low voltage primary side and medium/high voltage secondary side and enables the users to obtain reliable and accurate energy consumption readings from the monitored equipments in real time under operation. These compact size and cost-effective power meters monitoring equipment with Rogowski Coil CT is "rope-style" Current Transformer which delivers "Easy Installation" features for large window size (55 ~ 105mm) and mechanical flexibility for tight space.

It operates over a wide range of input voltages 10 ~ 500 VAC which allows universal compatibility. Also, with 2 channels relay outputs, it can be linked with sirens or lightings for alarm messages. It also supports Modbus RTU, Modbus TCP or CANopen protocols for easy integration.

## Specifications:

Models	PM-3133-RCT	PM-3133-RCT-MTCP	PM-3133-RCT-CPS
<b>AC Power Measurement</b>			
Wiring	3P4W-3CT, 3P3W-2CT, 3P3W-3CT, 1P2W-1CT, 1P3W-2CT		
Measurement Voltage	10 ~ 500 V		
Measurement Current	CTØ55 mm (500 A), CTØ80 mm (1000 A), CTØ105 mm (2000 A)		
Measurement Frequency	50/60 Hz		
W Accuracy	Better than 1% (PF=1; Input Current >50 A)		
Power Parameter Measurement	True RMS voltage (Vrms), True RMS current (Irms), Active Power (kW), Active Energy (kWh), Apparent Power (kVA), Apparent Energy (kVAh), Reactive Power (kVAR), Reactive Energy (kVARh), Power Factor (PF), Frequency, THD		
Data Update Rate	1 Second		
<b>Communication</b>			
Interface	RS-485	Ethernet (PoE)	CANopen
Protocol	Modbus-RTU	Modbus TCP	CANopen
Baud rate	9600,19200 (default), 38400, 115200; DIP Switch Selectable	-	125 k (default), 250 k, 500 k, 1 M; DIP Switch Selectable
Data format	N,8,1 (default); N,8,2; E,8,1; E,8,2; O,8,1; O,8,2	-	-
Isolation	3000 VDC	-	3000 VDC
<b>Alarm Output</b>			
Power Relay	Form A (Normal Open) × 2; Relay Contact Voltage Range: 5 A @ 250 VAC (47 ~ 63Hz), 5 A @ 30 VDC		
<b>Power</b>			
Power Input	+12 ~ 48 VDC	+12 ~ 48 VDC or PoE	+12 ~ 48 VDC
Power Consumption	2 W		
<b>Environment</b>			
Temperature	Operating Temperature: -20 ~ +70 °C / Storage Temperature: -25 ~ +80 °C		
Ambient Relative Humidity	10% ~ 90% RH, Non-condensing		

### Installation:

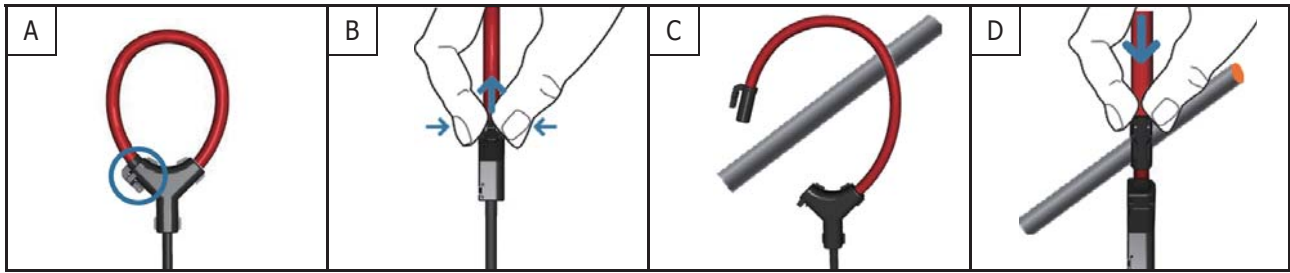

Rogowski Coil Soft CT Installation



### Dimensions (Units: mm):

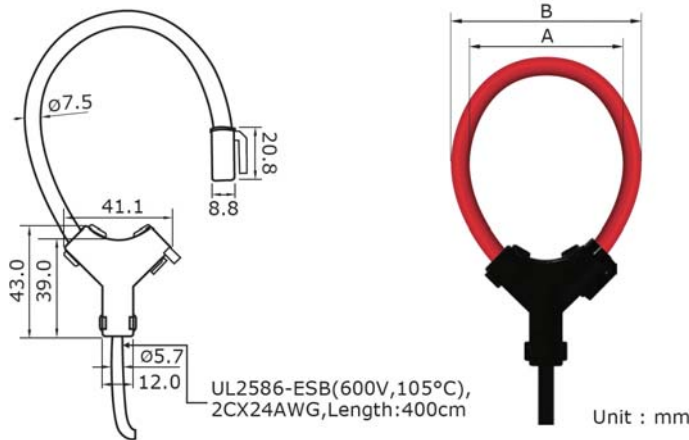

Models	A	B
PM-3133-RCT500P	55.0	68.5
PM-3133-RCT1000P	80.0	93.5
PM-3133-RCT2000P	105.0	118.5

### Ordering Information:

RS-485 Interface	
PM-3133-RCT500P	Modbus RTU, 3-phase power meter, 500A Rogowski Coil CT
PM-3133-RCT1000P	Modbus RTU, 3-phase power meter, 1000A Rogowski Coil CT
PM-3133-RCT2000P	Modbus RTU, 3-phase power meter, 2000A Rogowski Coil CT

Ethernet Interface <b>Available soon</b>	
PM-3133-RCT500P-MTCP	Modbus TCP, 3-phase power meter, 500A Rogowski Coil CT
PM-3133-RCT1000P-MTCP	Modbus TCP, 3-phase power meter, 1000A Rogowski Coil CT
PM-3133-RCT2000P-MTCP	Modbus TCP, 3-phase power meter, 2000A Rogowski Coil CT

CANopen Interface <b>Available soon</b>	
PM-3133-RCT500P-CPS	CANopen, 3-phase power meter, 500A Rogowski Coil CT
PM-3133-RCT1000P-CPS	CANopen, 3-phase power meter, 1000A Rogowski Coil CT
PM-3133-RCT2000P-CPS	CANopen, 3-phase power meter, 2000A Rogowski Coil CT



# Three-phase Smart Power Meter



**PM-3133/-MTCP/-CPS**

## Features:



- True RMS Power Measurements
- Energy Analysis for 3P4W, 3P3W, 1P3W, 1P2W
- Current Measurements Up to 400 A with Different CT Ratio
- Voltage Measurements Up to 500 V
- Clip-on CT for Easy Installation
- W Accuracy Better than 0.5% (PF=1)
- Supports RS-485, Ethernet (PoE) or CANopen Interface
- Supports Modbus RTU, Modbus TCP or CANopen Protocol
- Supports 2 Power Relay Output (Form A)
- Total Harmonic Distortion (THD)
- IEC 61010-1 and EN 61010-1
- Multiple Data Format

## Introduction:

ICP DAS brings the most powerful, cost-effective, advanced Smart Power Meters PM-3133 series that gives you access to real-time electric usage for three-phase power measurement. With its high accuracy (<0.5%, PF=1), the PM-3133 series can be applied to both low voltage primary side and/or medium/high voltage secondary side and enables the users to obtain reliable and accurate energy consumption readings from the monitored equipments in real time under operation. These compact size and cost-effective power meters are equipped with revolutionary wired clip-on CT (various types, support input current up to 400 A). It operates over a wide input voltages range 10 ~ 500 VAC which allows worldwide compatibility. And with 2 channels relay outputs, it can be linked with sirens or lightings for alarm messages. It also supports Modbus RTU, Modbus TCP or CANopen protocols for easy integration. You can use CT's that you currently own with PM-3133P (without CTs) Power Meter. The CT inputs of the PM-3133P can handle a maximum of 333mV of AC current.

## Specifications:

Models	PM-3133	PM-3133-MTCP	PM-3133-CPS
<b>AC Power Measurement</b>			
Wiring	3P4W-3CT, 3P3W-2CT, 3P3W-3CT, 1P2W-1CT, 1P3W-2CT		
Measurement Voltage	10 ~ 500 V		
Measurement Current	CTØ10 mm (60 A); CTØ16 mm (100 A); CTØ24 mm (200 A); CTØ36 mm (300 A); CTØ36 mm (400 A)		
Measurement Frequency	50/60 Hz		
W Accuracy	Better than 0.5% (PF=1)		
Power Parameter Measurement	True RMS voltage (V <sub>rms</sub> ), True RMS current (I <sub>rms</sub> ), Active Power (kW), Active Energy (kWh), Apparent Power (kVA), Apparent Energy (kVAh), Reactive Power (kVAR), Reactive Energy (kVARh), Power Factor (PF), Frequency		
Data Update Rate	1 Second		
<b>Communication</b>			
RS-485	Protocol	Modbus-RTU	-
	Baud rate	9600,19200 (default), 38400, 115200; DIP Switch Selectable	-
	Data format	N,8,1 (default); N,8,2; E,8,1; E,8,2; O,8,1; O,8,2	-
	Isolation	3000 VDC	-
Ethernet (PoE)	Protocol	-	Modbus TCP
CANopen	Protocol	-	CANopen
	Baud rate	-	125 k (default), 250 k, 500 k, 1 M; DIP Switch Selectable
	Isolation	-	3000 VDC
<b>Alarm Output</b>			
Power Relay	Form A (Normal Open) × 2; Relay Contact Voltage Range: 5 A @ 250 VAC (47 ~ 63Hz), 5 A @ 30 VDC		
<b>Power</b>			
Power Input	+12 ~ 48 VDC	+12 ~ 48 VDC or PoE	+12 ~ 48 VDC
Power Consumption	2 W		
<b>Environment</b>			
Temperature	Operating Temperature: -20 ~ +70°C / Storage Temperature: -25 ~ +80°C		
Ambient Relative Humidity	10% ~ 90% RH, Non-condensing		

**Appearance:**

**LED indicators**

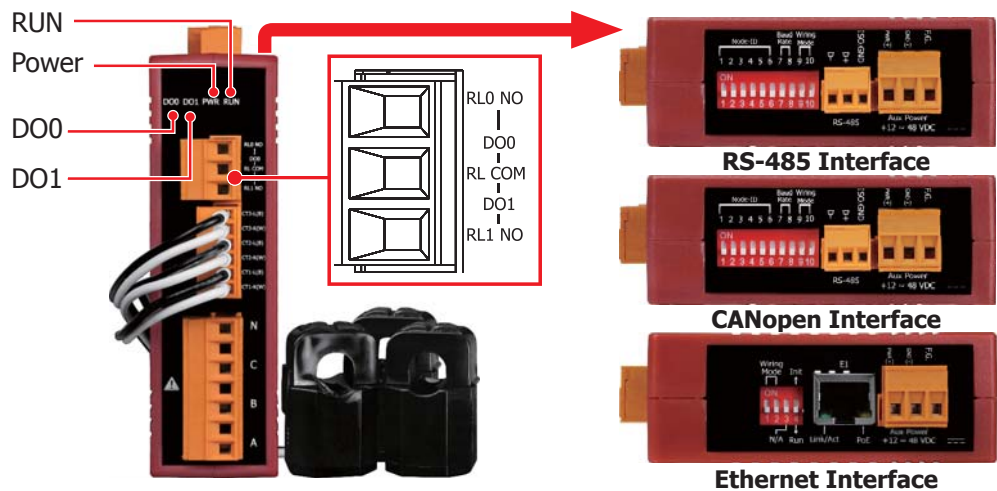

**Dimensions (Units: mm):**

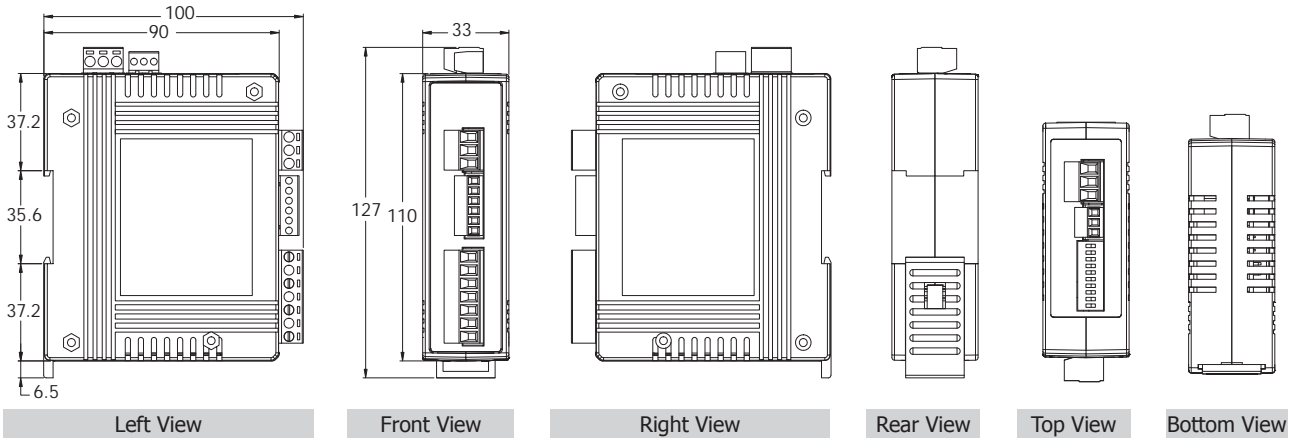

**Selection Guide:**

**PM-3133 - X X X P - X X X**

**CT size (measurement)**

- 100: CTΦ10 mm, 60 A Max.
- 160: CTΦ16 mm, 100 A Max.
- 240: CTΦ24 mm, 200 A Max.
- 360P: CTΦ36 mm, 300 A Max.
- 400P: CTΦ36 mm, 400 A Max.

**Current Transformers**

(Secondary voltage 333mV)

**Communication**

- : RS-485
- CPS: CANopen
- MTCP: Modbus TCP

**Ordering Information:**

RS-485 Interface	
<b>PM-3133P</b>	Modbus RTU, 3-phase power meter (Compatible with CTs from 50 to 1000 A/333 mV output)
<b>PM-3133-100</b>	Modbus RTU, 3-phase power meter (60 A)
<b>PM-3133-160</b>	Modbus RTU, 3-phase power meter (100 A)
<b>PM-3133-240</b>	Modbus RTU, 3-phase power meter (200 A)
<b>PM-3133-360P</b>	Modbus RTU, 3-phase power meter (300 A)
<b>PM-3133-400P</b>	Modbus RTU, 3-phase power meter (400 A)

Ethernet Interface	
<b>PM-3133-100-MTCP</b>	Modbus TCP, 3-phase power meter (60 A)
<b>PM-3133-160-MTCP</b>	Modbus TCP, 3-phase power meter (100 A)
<b>PM-3133-240-MTCP</b>	Modbus TCP, 3-phase power meter (200 A)
<b>PM-3133-360P-MTCP</b>	Modbus TCP, 3-phase power meter (300 A)
<b>PM-3133-400P-MTCP</b>	Modbus TCP, 3-phase power meter (400 A)

CANopen Interface	
<b>PM-3133-100-CPS</b>	CANopen, 3-phase power meter (60 A)
<b>PM-3133-160-CPS</b>	CANopen, 3-phase power meter (100 A)
<b>PM-3133-240-CPS</b>	CANopen, 3-phase power meter (200 A)
<b>PM-3133-360P-CPS</b>	CANopen, 3-phase power meter (300 A)
<b>PM-3133-400P-CPS</b>	CANopen, 3-phase power meter (400 A)

# Three-phase Smart Power Meter



**PM-3033/-MTCP/-CPS**

## Features:



- True RMS Power Measurements
- Energy Analysis for 3P4W, 3P3W, 1P3W, 1P2W
- Direct input of secondary side 1A/5A CT
- Voltage Measurements Up to 500 V
- W Accuracy Better than 0.5% (PF=1)
- Supports RS-485, Ethernet (PoE) or CANopen Interface
- Supports Modbus RTU/Modbus TCP or CANopen Protocol
- Total Harmonic Distortion (THD)
- IEC 61010-1 and EN 61010-1
- Multiple Data Format
- IEC 61010-1and EN 61010-1

## Introduction:

ICP DAS brings the most powerful, cost-effective, advanced Smart Power Meters PM-3033 series that gives you access to real-time electric usage for three-phase power measurement. With its high accuracy (<0.5%, PF=1 ), the PM-3033 series can be applied to both low voltage primary side and/or medium/high voltage secondary side and enables the users to obtain reliable and accurate energy consumption readings from the monitored equipments in real time under operation.

Direct input from "secondary side 1A/5A" type CTs. Dedicated CTs are no longer needed, which lowers the cost of implementation. It operates over a wide input voltages range 10 ~ 500 VAC which allows worldwide compatibility. It also supports Modbus RTU, Modbus TCP or CANopen protocols for easy integration.

## Specifications:

Models	PM-3033	PM-3033-MTCP	PM-3033-CPS
<b>AC Power Measurement</b>			
Wiring	3P4W-3CT, 3P3W-2CT, 3P3W-3CT, 1P2W-1CT, 1P3W-2CT		
Measurement Voltage	10 ~ 500 V		
Measurement Current	1A or 5A		
Measurement Frequency	50/60 Hz		
W Accuracy	Better than 0.5% (PF=1)		
Power Parameter Measurement	True RMS voltage (Vrms), True RMS current (Irms), Active Power (kW), Active Energy (kWh), Apparent Power (kVA), Apparent Energy (kVAh), Reactive Power (kVAR), Reactive Energy (kVARh), Power Factor (PF), Frequency		
Data Update Rate	1 Second		
<b>Communication</b>			
RS-485	Protocol	Modbus-RTU	-
	Baud rate	9600,19200 (default), 38400, 115200; DIP Switch Selectable	-
	Data format	N,8,1 (default); N,8,2; E,8,1; E,8,2; O,8,1; O,8,2	-
	Isolation	3000 VDC	-
Ethernet (PoE)	Protocol	-	Modbus TCP
CANopen	Protocol	-	CANopen
	Baud rate	-	125 k (default), 250 k, 500 k, 1 M; DIP Switch Selectable
	Isolation	-	3000 VDC
<b>Power</b>			
Power Input	+12 ~ 48 VDC	+12 ~ 48 VDC or PoE	+12 ~ 48 VDC
Power Consumption	2 W		
<b>Environment</b>			
Temperature	Operating Temperature: -20 ~ +70°C / Storage Temperature: -25 ~ +80°C		
Ambient Relative Humidity	10% ~ 90% RH, Non-condensing		



### CT Installation and Wiring:

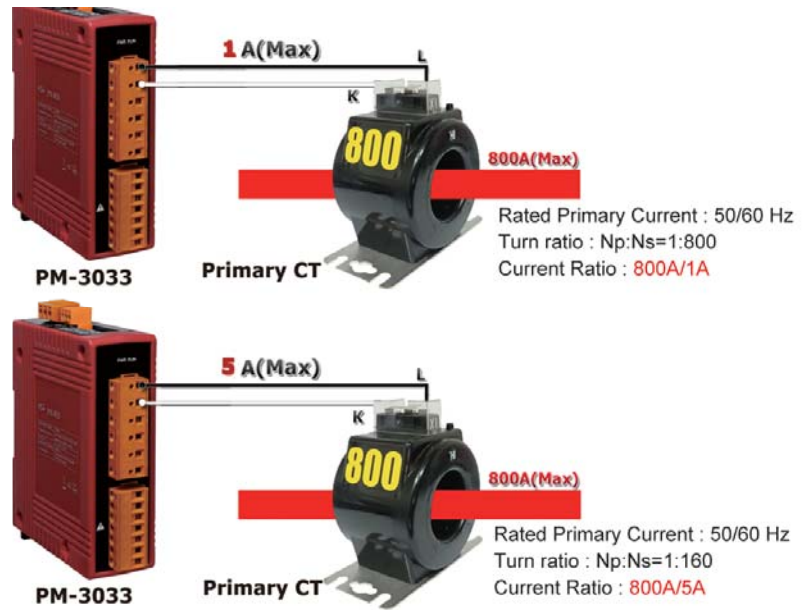
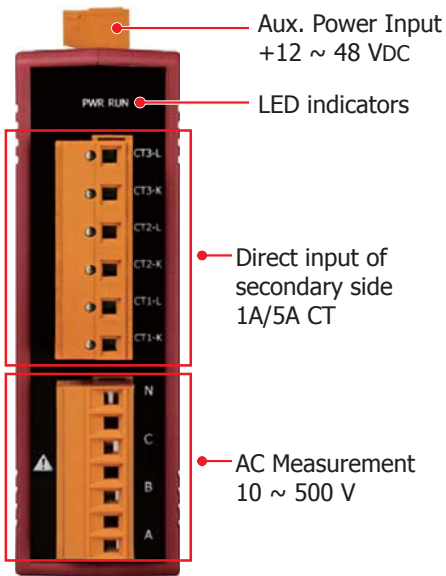

### Dimensions (Units: mm):

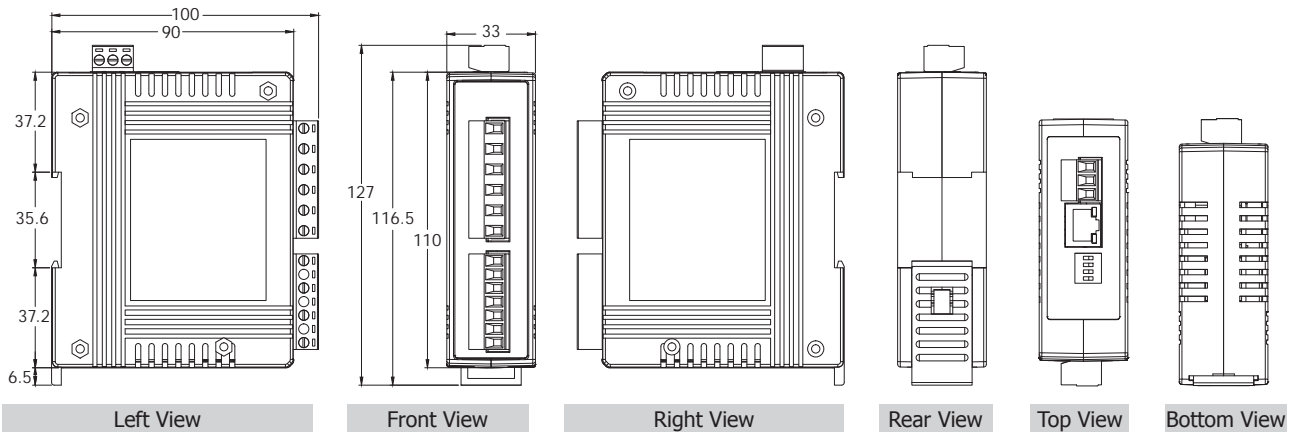

### Selection Guide:

**PM-3033 - XXX**

↓

**Communication**

- : RS-485
- CPS: CANopen
- MTCP: Modbus TCP

### Ordering Information:

RS-485 Interface	
<b>PM-3033</b>	Modbus RTU, 3-phase power meter (1A/5A CT Input type)
Ethernet Interface	
<b>PM-3033-MTCP</b>	Modbus TCP, 3-phase power meter (1A/5A CT Input type)
CANopen Interface	
<b>PM-3033-CPS</b>	CANopen, 3-phase power meter (1A/5A CT Input type)

# Single-phase Smart Power Meter



**PM-3112/-MTCP/-CPS**  
**PM-3114/-MTCP/-CPS**

## Features:



- True RMS Power Measurements
- Energy Analysis for 1P2W, 1P4W
- Current Measurements Up to 200 A with Different CT Ratio
- Voltage Measurements Up to 300 V
- Clip-on CT for Easy Installation
- W Accuracy Better than 0.5% (PF=1)
- Supports RS-485, Ethernet or CANopen Interface
- Supports Modbus RTU, Modbus TCP or CANopen Protocol
- Supports 2 Power Relay Output (Form A)
- IEC 61010-1 and EN 61010-1
- Multiple Data Format

## Introduction:

ICP DAS brings the most powerful, cost-effective, advanced Smart Power Meters PM-3000 series that gives you access to real-time electric usage for single-phase power measurement. With its high accuracy ( $< 0.5\%$ ,  $PF=1$ ), the PM-3000 series can be applied to both low voltage primary side and/or medium/high voltage secondary side and enables the users to obtain reliable and accurate energy consumption readings from the monitored equipments in real time under operation. These compact size and cost-effective power meters are equipped with revolutionary wired clip-on CT (various types, support input current up to 200 A). It operates over a wide input voltages range  $10 \sim 300$  VAC which allows worldwide compatibility. And with 2 channels relay outputs, it can be linked with sirens or lightings for alarm messages. It also supports Modbus RTU, Modbus TCP or CANopen protocols for easy integration.

## Specifications:

Models	PM-3112	PM-3114	PM-3112-MTCP	PM-3114-MTCP	PM-3112-CPS	PM-3114-CPS
<b>AC Power Measurement</b>						
Wiring	1P2W-2CT	1P4W-4CT	1P2W-2CT	1P4W-4CT	1P2W-2CT	1P4W-4CT
Input Voltage	10 ~ 300 V					
Input Current	CTØ10 mm (60 A); CTØ16 mm (100 A); CTØ24 mm (200 A)					
Input Frequency	50/60 Hz					
W Accuracy	Better than 0.5% (PF=1)					
Starting Current	$>0.03A$ ( 60A ), $>0.05A$ (100A) , $>0.09A$ ( 200A )					
Power Parameter Measurement	True RMS voltage (Vrms), True RMS current (Irms), Active Power (kW), Active Energy (kWh), Apparent Power (kVA), Apparent Energy (kVAh), Reactive Power (kVAR), Reactive Energy (kVARh), Power Factor (PF), Frequency					
Data Update Rate	1 Second					
<b>Communication</b>						
RS-485	Protocol	Modbus-RTU		-	-	
	Baud rate	9600,19200 (default), 38400, 115200; DIP Switch Selectable		-	-	
	Data format	N,8,1 (default); N,8,2; E,8,1; E,8,2; O,8,1; O,8,2		-	-	
	Isolation	3000 VDC		-	-	
Ethernet (PoE)	Protocol	-	Modbus TCP		-	
CANopen	Protocol	-	-		CANopen	
	Baud rate	-	-		125 k (default), 250 k, 500 k, 1 M; DIP Switch Selectable	
<b>Alarm Output</b>						
Power Relay	Form A (Normal Open) × 2; Relay Contact Voltage Range: 5 A @ 250 VAC (47 ~ 63 Hz), 5 A @ 30 VDC					
<b>Power</b>						
Input Range	+12 ~ 48 Vdc		+12 ~ 48 VDC		+12 ~ 48 VDC	
Power Consumption	2 W					
<b>Environment</b>						
Temperature	Operating Temperature: $-20 \sim +70^{\circ}\text{C}$ / Storage Temperature: $-25 \sim +80^{\circ}\text{C}$					
Ambient Relative Humidity	10% ~ 90% RH, Non-condensing					

### Appearance:

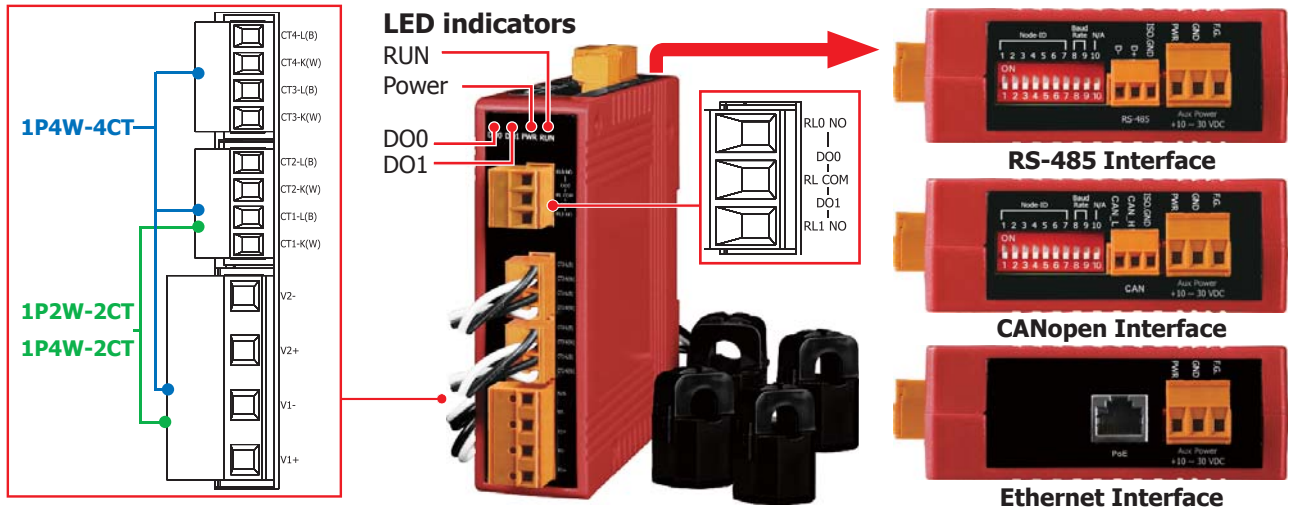

### Dimensions (Units: mm):

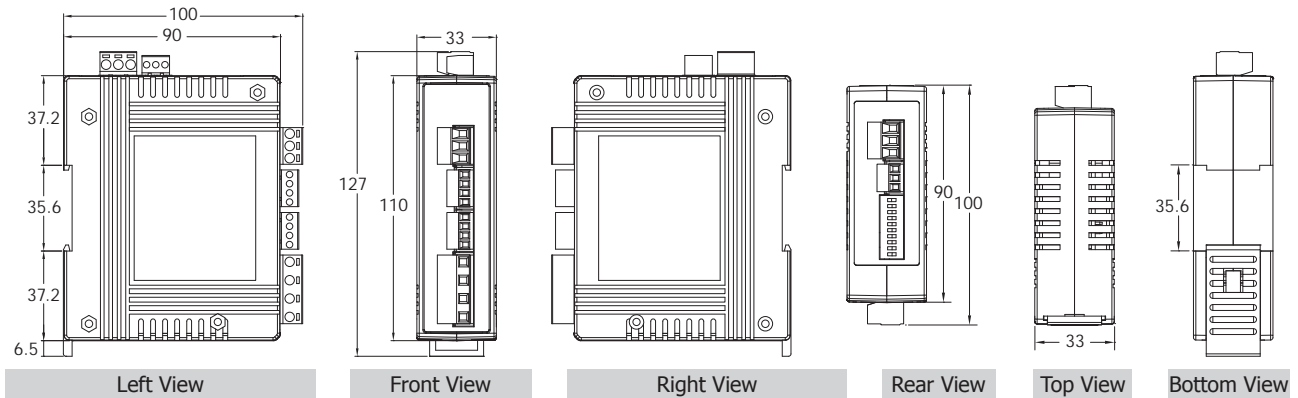

### Selection Guide:

**PM-311** **X** - **X X X** - **X X X**

**Channel**  
 2: 2 Circuits  
 4: 4 Circuits

**CT size (measurement)**  
 100: CTΦ10 mm (0 ~ 60 A)  
 160: CTΦ16 mm (0 ~ 100 A)  
 240: CTΦ24 mm (0 ~ 200 A)

**Communication**  
 □: RS-485  
 CPS: CANopen  
 MTCP: Modbus TCP

### Ordering Information:

RS-485 Interface	
PM-3112-100	Modbus RTU, 2 single-phase circuits Power Meter with 2 CTs (60 A)
PM-3112-160	Modbus RTU, 2 single-phase circuits Power Meter with 2 CTs (100 A)
PM-3112-240	Modbus RTU, 2 single-phase circuits Power Meter with 2 CTs (200 A)
Ethernet Interface	
PM-3112-100-MTCP	Modbus TCP, 2 single-phase circuits Power Meter with 2 CTs (60 A)
PM-3112-160-MTCP	Modbus TCP, 2 single-phase circuits Power Meter with 2 CTs (100 A)
PM-3112-240-MTCP	Modbus TCP, 2 single-phase circuits Power Meter with 2 CTs (200 A)
CANopen Interface	
PM-3112-100-CPS	CANOpen, 2 single-phase circuits Power Meter with 2 CTs (60 A)
PM-3112-160-CPS	CANOpen, 2 single-phase circuits Power Meter with 2 CTs (100 A)
PM-3112-240-CPS	CANOpen, 2 single-phase circuits Power Meter with 2 CTs (200 A)

RS-485 Interface	
PM-3114-100	Modbus RTU, 4 single-phase circuits power meter (60 A)
PM-3114-160	Modbus RTU, 4 single-phase circuits power meter (100 A)
PM-3114-240	Modbus RTU, 4 single-phase circuits power meter (200 A)
Ethernet Interface	
PM-3114-100-MTCP	Modbus TCP, 4 single-phase circuits power meter (60 A)
PM-3114-160-MTCP	Modbus TCP, 4 single-phase circuits power meter (100 A)
PM-3114-240-MTCP	Modbus TCP, 4 single-phase circuits power meter (200 A)
CANopen Interface	
PM-3114-100-CPS	CANOpen, 4 single-phase circuits power meter (60 A)
PM-3114-160-CPS	CANOpen, 4 single-phase circuits power meter (100 A)
PM-3114-240-CPS	CANOpen, 4 single-phase circuits power meter (200 A)



# Multi-circuit Smart Power Meter



## PM-4324/-MTCP/-CPS PM-4324A/-MTCP/-CPS

### Features:



- 8 Three Phase Circuits or 24 Single Phase Circuits
- True RMS Power Measurements
- Energy Analysis for 3P4W, 3P3W, 1P3W, 1P2W
- 2 Independent main circuit inputs for PM-4324A series
- Current Measurements Up to 400 A with Different CT Ratio
- Voltage Measurements Up to 500 V
- Easy install with split core CT
- W Accuracy Better than 0.5% (PF=1)
- Support RS-485, Ethernet or CAN bus Interface
- Support 2 Power Relay Output (Form A)
- Total Harmonic Distortion (THD)
- Multiple Data Format

### Introduction:

The **PM-4324 series** multi-circuit power meter monitors up to 8 three-phase circuits or 24 single-phase circuits, or any combination of single or three-phase circuits. The PM-4324 series can measure up to 24 currents via external Current Transformers (CTs). This flexibility makes the PM-4324 series perfect for multi-tenant facilities such as residential projects, office buildings and shopping malls. This compact instrument is designed to easily fit into existing panelboards or be flush mounted nearby, thus eliminating the need for expensive retrofit projects or for allocating extra space for the device.

The PM-4324A is the same model as the PM-4324, except for the AC Measurement. The PM-4324A has 2 separate main circuit inputs that can use in the different power system.

### Specifications:

Models	PM-4324/PM-4324A	PM-4324-MTCP/ PM-4324A-MTCP	PM-4324-CPS/ PM-4324A-CPS
<b>AC Power Measurement</b>			
Wiring	3P4W-3CT, 3P3W-2CT, 3P3W-3CT, 1P2W-1CT, 1P3W-2CT		
Measurement Voltage	10 ~ 500 V		
Measurement Current	CTØ10 mm (60 A); CTØ16 mm (100 A); CTØ24 mm (200 A); CTØ36 mm (300 A); CTØ36 mm (400 A)		
Measurement Frequency	50/60 Hz		
W Accuracy	Better than 0.5% (PF=1)		
Power Parameter Measurement	True RMS voltage (V <sub>rms</sub> ), True RMS current (I <sub>rms</sub> ), Active Power (kW), Active Energy (kWh), Apparent Power (kVA), Apparent Energy (kVAh), Reactive Power (kVAR), Reactive Energy (kVARh), Power Factor (PF), Frequency		
Data Update Rate	1 Second		
<b>Communication</b>			
Interface	RS-485	Ethernet	CAN Bus
Protocol	Modbus-RTU	Modbus TCP	CANopen
Baud rate	9600,19200 (default), 38400, 115200; DIP Switch Selectable	-	125 k (default), 250 k, 500 k, 1 M; DIP Switch Selectable
Data format	N,8,1; N,8,2; E,8,1; E,8,2; O,8,1; O,8,2	-	-
Isolation	3000 VDC	-	3000 VDC
<b>Alarm Output</b>			
Power Relay	Form A (Normal Open) × 2; Relay Contact Voltage Range: 5 A @ 250 VAC (47 ~ 63 Hz), 5 A @ 30 VDC		
<b>Power</b>			
Input Range	+85 ~ +264 VAC		
Power Consumption	6 W		
<b>Mechanical</b>			
Dimensions / Casing	237 mm × 52 mm × 134 mm (W × L × H) / Plastic		
Module Installation	DIN-Rail Mounting; Wall mounting		
<b>Environment</b>			
Temperature	Operating Temperature: -20 ~ +70°C / Storage Temperature: -25 ~ +80°C		
Ambient Relative Humidity	10% ~ 90% RH, Non-condensing		

Appearance:

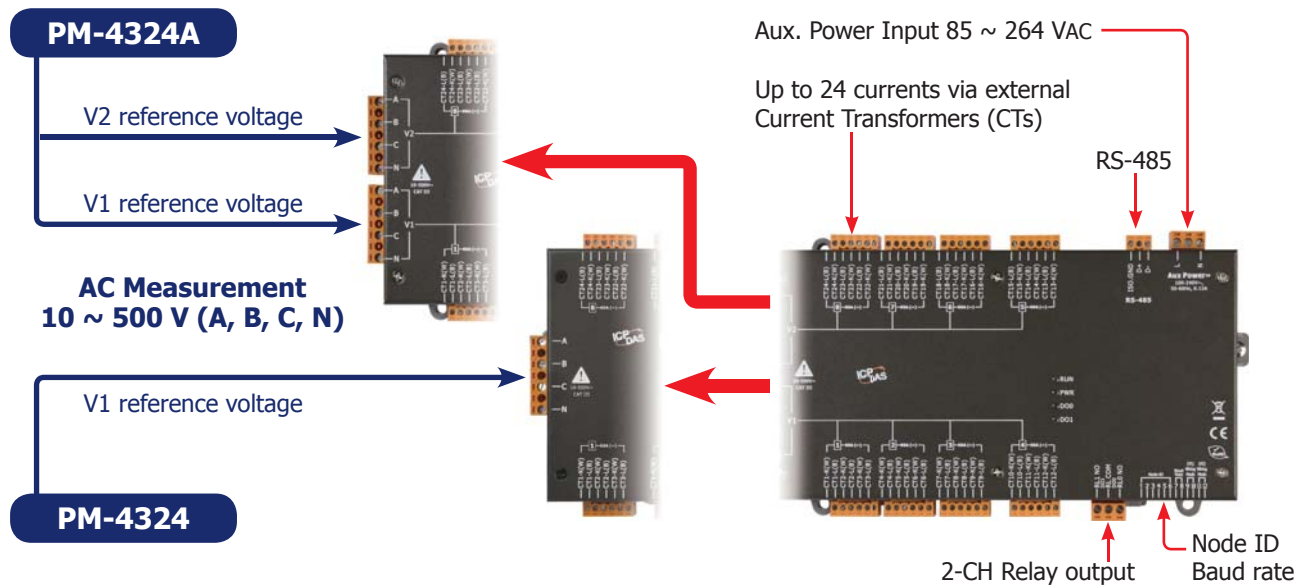

Selection Guide:

**PM-4324** **A** - **XXX** **P** - **XXX**

- A**: 2 independent main circuit inputs
- XXX**: CT size (measurement)
  - 100P: CTΦ10 mm, 60 A Max.
  - 160P: CTΦ16 mm, 100 A Max.
  - 240P: CTΦ24 mm, 200 A Max.
  - 360P: CTΦ36 mm, 300 A Max.
  - 400P: CTΦ36 mm, 400 A Max.
- P**: Current Transformers (Secondary voltage 333mV)
- XXX**: Communication
  - : RS-485
  - CPS: CANopen
  - MTCP: Modbus TCP

Ordering Information:

RS-485 Interface			
<b>PM-4324P</b>	Modbus RTU, Multi-Circuit Power Meter (Can be directly input from the secondary side of 333mV CT)		
<b>PM-4324-100P</b>	Modbus RTU, Multi-Circuit Power Meter (60 A)	<b>PM-4324A-100P</b>	Modbus RTU, Multi-Circuit Power Meter (60 A)
<b>PM-4324-160P</b>	Modbus RTU, Multi-Circuit Power Meter (100 A)	<b>PM-4324A-160P</b>	Modbus RTU, Multi-Circuit Power Meter (100 A)
<b>PM-4324-240P</b>	Modbus RTU, Multi-Circuit Power Meter (200 A)	<b>PM-4324A-240P</b>	Modbus RTU, Multi-Circuit Power Meter (200 A)
<b>PM-4324-360P</b>	Modbus RTU, Multi-Circuit Power Meter (300 A)	<b>PM-4324A-360P</b>	Modbus RTU, Multi-Circuit Power Meter (300 A)
<b>PM-4324-400P</b>	Modbus RTU, Multi-Circuit Power Meter (400 A)	<b>PM-4324A-400P</b>	Modbus RTU, Multi-Circuit Power Meter (400 A)
Ethernet Interface			
<b>PM-4324-100P-MTCP</b>	Modbus TCP, Multi-Circuit Power Meter (60 A)	<b>PM-4324A-100P-MTCP</b>	Modbus TCP, Multi-Circuit Power Meter (60 A)
<b>PM-4324-160P-MTCP</b>	Modbus TCP, Multi-Circuit Power Meter (100 A)	<b>PM-4324A-160P-MTCP</b>	Modbus TCP, Multi-Circuit Power Meter (100 A)
<b>PM-4324-240P-MTCP</b>	Modbus TCP, Multi-Circuit Power Meter (200 A)	<b>PM-4324A-240P-MTCP</b>	Modbus TCP, Multi-Circuit Power Meter (200 A)
<b>PM-4324-360P-MTCP</b>	Modbus TCP, Multi-Circuit Power Meter (300 A)	<b>PM-4324A-360P-MTCP</b>	Modbus TCP, Multi-Circuit Power Meter (300 A)
<b>PM-4324-400P-MTCP</b>	Modbus TCP, Multi-Circuit Power Meter (400 A)	<b>PM-4324A-400P-MTCP</b>	Modbus TCP, Multi-Circuit Power Meter (400 A)
CANopen Interface			
<b>PM-4324-100P-CPS</b>	CANOpen, Multi-Circuit Power Meter (60 A)	<b>PM-4324A-100P-CPS</b>	CANOpen, Multi-Circuit Power Meter (60 A)
<b>PM-4324-160P-CPS</b>	CANOpen, Multi-Circuit Power Meter (100 A)	<b>PM-4324A-160P-CPS</b>	CANOpen, Multi-Circuit Power Meter (100 A)
<b>PM-4324-240P-CPS</b>	CANOpen, Multi-Circuit Power Meter (200 A)	<b>PM-4324A-240P-CPS</b>	CANOpen, Multi-Circuit Power Meter (200 A)
<b>PM-4324-360P-CPS</b>	CANOpen, Multi-Circuit Power Meter (300 A)	<b>PM-4324A-360P-CPS</b>	CANOpen, Multi-Circuit Power Meter (300 A)
<b>PM-4324-400P-CPS</b>	CANOpen, Multi-Circuit Power Meter (400 A)	<b>PM-4324A-400P-CPS</b>	CANOpen, Multi-Circuit Power Meter (400 A)

## CT for Smart Power Meter

### Dimensions (Units: mm):

100: CTΦ10mm (60 A Max.)

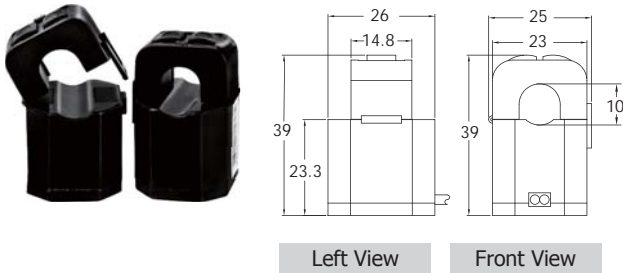

360P: CTΦ36mm (300 A Max.)

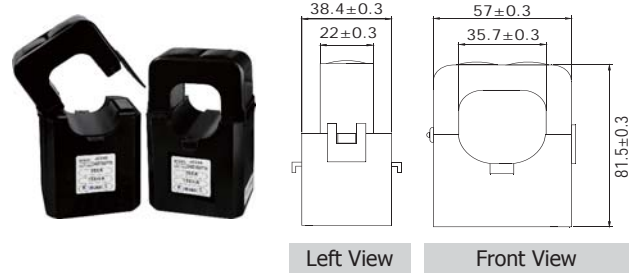

160: CTΦ16mm (100 A Max.)

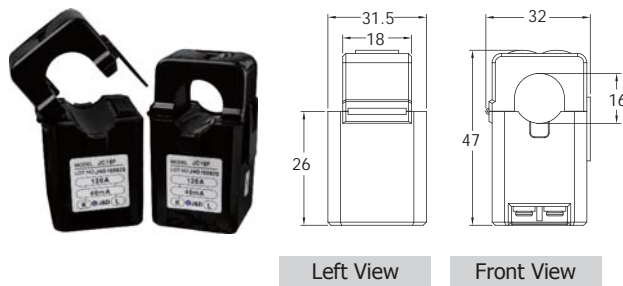

400P: CTΦ36mm (400 A Max.)

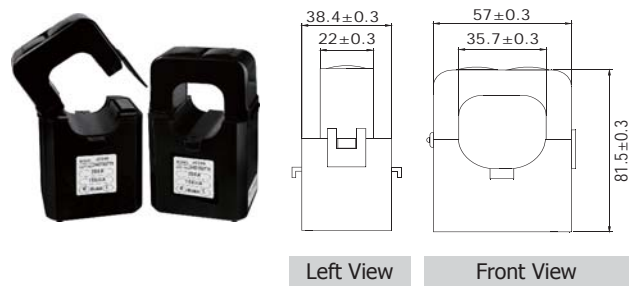

240: CTΦ24mm (200 A Max.)



RCT500P: CTΦ55mm (500 A Max.)

RCT1000P: CTΦ80mm (1000 A Max.)

RCT2000P: CTΦ105mm (2000 A Max.)

Models	A	B
PM-3133-RCT500P	55.0	68.5
PM-3133-RCT1000P	80.0	93.5
PM-3133-RCT2000P	105.0	118.5



### Installation:

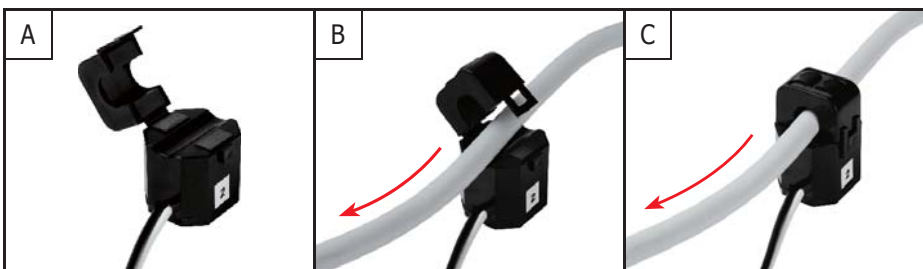

Clip-on CT Installation



DIN-Rail Mounting  
(EX: PM-3133)

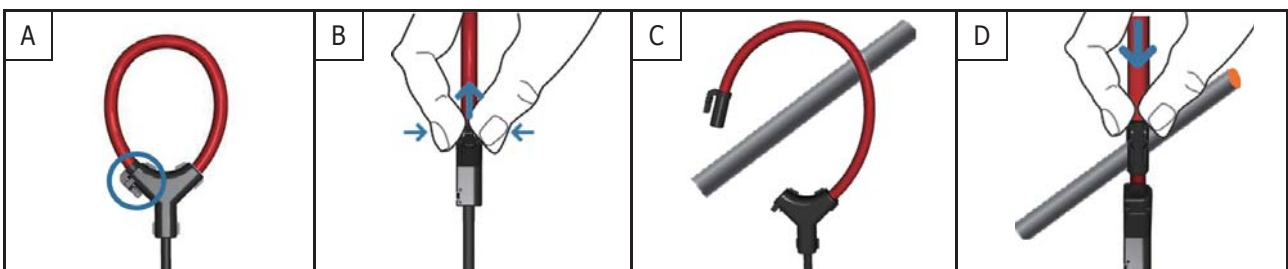

Rogowski coil Soft CT Installation



# 8-channel True RMS Input Module



**M-7017RMS**

## Introduction:

The M-7017RMS is an 8-channel differential AC input module that is used to convert the AC input signals to their True RMS DC values. The RMS input range can be from +150 mVrms to +10 Vrms, and each channel can be configured individually. The M-7017RMS is a complete, high-accuracy, RMS-to-DC converter that computes the True RMS DC value of any complex waveform. It also features 4 kV ESD protection, 2500 VDC intra-module isolation and ±35 VDC overvoltage protection.

## System Specifications:

Communication	
Interface	RS-485
Bias Resistor	No (Usually supplied by the RS-485 Master. Or, add a tM-SG4 or SG-785.)
Baud Rate	1200 to 115200 bps
Protocol	Modbus RTU, DCON
Dual Watchdog	Yes, Module (1.6 Seconds), Communication (Programmable)
LED Indicators/Display	
System LED Indicator	1 as Power/Communication Indicator
Isolation	
Intra-module Isolation, Field-to-Logic	2500 VDC
EMS Protection	
ESD (IEC 61000-4-2)	±4 kV Contact for each Terminal ±8 kV Air for Random Point
EFT (IEC 61000-4-4)	±4 kV for Power Line
Surge (IEC 61000-4-5)	±0.5 kV for Power Line
Power	
Reverse Polarity Protection	Yes
Input	+10 ~ +30 Vdc
Consumption	0.9 W
Mechanical	
Dimensions (L × W × H)	123 mm × 72 mm × 35 mm
Installation	DIN-Rail
Environment	
Operating Temperature	-25 to +75°C
Storage Temperature	-40 to +85°C
Humidity	10 to 95% RH, Non-condensing

## Features:



- 8-channel True RMS Input
- ±0.15% Factory Calibrated Accuracy
- The RMS input range: +150 mVrms ~ +10 Vrms
- For Standard Operation with Frequencies: 45 Hz ~ 10 KHz
- Individual Channel Configurable

## Applications:

- Building Automation
- Factory Automation
- Machine Automation
- Remote Maintenance
- Remote Diagnosis
- Testing Equipment

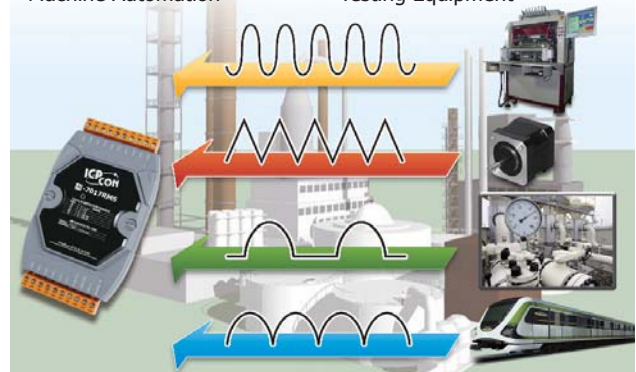

## I/O Specifications:

Analog Input		
Channels	8	
Wiring	Differential	
Input Range	0 ~ +10 Vrms, 0 ~ +5 Vrms, 0 ~ +1 Vrms, 0 ~ +500 mVrms, 0 ~ +150 mVrms	
Resolution	16-bit	
Accuracy	Sinusoid	
	50/60 Hz	±0.15% of FSR
	45 Hz to 10 kHz	±0.5% of FSR
	Non-Sinusoid	
	Crest Factor = 1 to 2	±0.2% of FSR
	Crest Factor = 2 to 3	±0.35% of FSR
DC	0 ~ +10 Vrms/ 0 ~ +5 Vrms/ 0 ~ +1 Vrms,	±0.3% of FSR
	Other	±0.7% of FSR
	Sampling Rate	10 Hz (Total)
-3dB Bandwidth	15.7 Hz	
Zero Drift	±20 µV/°C	
Span Drift	±25 ppm/°C	
Common Mode Rejection	86 dB	
Normal Mode Rejection	100 dB	
Input Impedance	>2 MΩ	
Individual Channel Configuration	Yes	
Overvoltage Protection	±35 VDC	

## DN-800 Series Voltage Attenuator and Current Transformer

### Introduction:

DN-800 series is a Voltage Attenuator and Current Transformer designed for used in high-voltage applications. The current can be converted into  $\pm 10$  Vpp attenuated signal, so that a general electronic measuring device is able to read the signals. Compared to ICP DAS power meter products (PM-3033, PM-3133, PM-4324, etc.), in addition to AC signals, the DN-800 series can convert DC signals as well.

The users can use appropriate ICP DAS Remote I/O Modules such as: M-7017R, I-87017RW, or ET-7217 to measure the converted  $\pm 10$  VDC signal via DN-800 series. And use M-7017RMS or I-87017W-RMS, etc. to measure the AC signals.

By using DN-800 series, the power data of all kinds of machines and AC/DC motors can be easily measured and retrieved, and then the analyzed data can be used to develop a model to build a failure warning system.

### Applications:

The operating current of AC or DC motor of the machines is converted into  $\pm 10$  Vpp attenuated signal via DNM-844, and then the  $\pm 10$  Vpp signal is converted based on Modbus / RTU protocol for seamless integration with all kinds of PLC or SCADA.

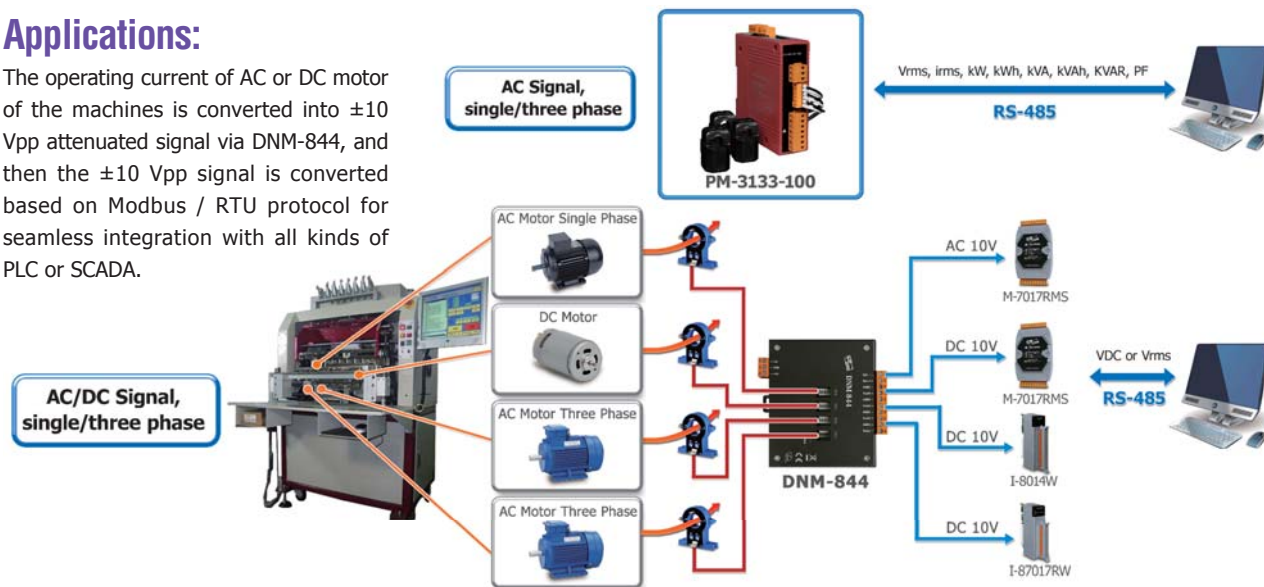

### Appearance and Specifications:

Model	Input Channel	Input Type	Input Range	CT Type	Cable	Output
	1 × Voltage, 1 × Current	AC/DC	$\pm 100$ Vpp, $\pm 50$ A	Clip-on $\varnothing 21$ mm	1.5 m/ 2.5 m	$\pm 10$ Vpp
			$\pm 100$ Vpp, $\pm 200$ A			
			$\pm 100$ Vpp, $\pm 500$ A			
			$\pm 100$ Vpp, $\pm 1000$ A	Clip-on $\varnothing 40.5$ mm	1.5 m	
			$\pm 100$ Vpp, $\pm 2000$ A			
			$\pm 50$ A,	Clip-on $\varnothing 21$ mm	1.5 m/ 2.5 m	
			$\pm 200$ A, $\pm 500$ A			
	4 × Current	AC/DC	$\pm 1000$ A	Clip-on $\varnothing 40.5$ mm	1.5 m	$\pm 10$ Vpp
			$\pm 2000$ A			
	3 × Voltage	AC/DC	$\pm 600$ Vpp	N/A	N/A	$\pm 10$ Vpp
	8 × Voltage	AC/DC	$\pm 10$ Vpp,	N/A	N/A	$\pm 10$ Vpp
			$\pm 80$ Vpp,			
			$\pm 150$ Vpp			
	3 × Current	AC/DC	$\pm 1$ A,	Solid Core (closed)	N/A	$\pm 1.6$ Vpp, $\pm 10$ Vpp, $\pm 10$ Vpp, $\pm 4$ Vpp
			$\pm 10$ A,			
			$\pm 20$ A,			
			$\pm 50$ A			

# Industrial Multi-power-meter Display



TPD-433-PM



TPD-703-PM



VPD-143N-PM



VPD-173-PM

**4.3" Series**

**7" Series**

## Features:



- Built-in HMI for Information Display of Power Meters
- 4.3"/7" Colorful Display with Touch Panel
- IP40/IP60 Ingress Protection for Front Panel
- Built-in Real Time Clock
- Support Modbus TCP/RTU Protocols
- Support Max. of 8 Single-phase/3-phase Power Meters (PM-3xxx series) or One PM-4324
- Support Max. of 4 Modbus/TCP Connections for SCADA Software
- Support Phase Sequence Detection
- Support Fine Tune of Voltage and Current Ratio

## Introduction:

The Industrial Multi-power-meter Display features 4.3"/7" high-resolution high-color TFT touch screen and IP40/IP65 waterproof. The built-in HMI screen pages for the information display of power meter, via the communication mechanism, can automatically display the meter information without additional programming. The multi-power-meter & multi-circuit device information can be shown in one display device, customers can now provide the display solution to the local end. Furthermore, the data can be integrated into the background SCADA control system, not only to get the power information, but also to facilitate the integration and configuration.

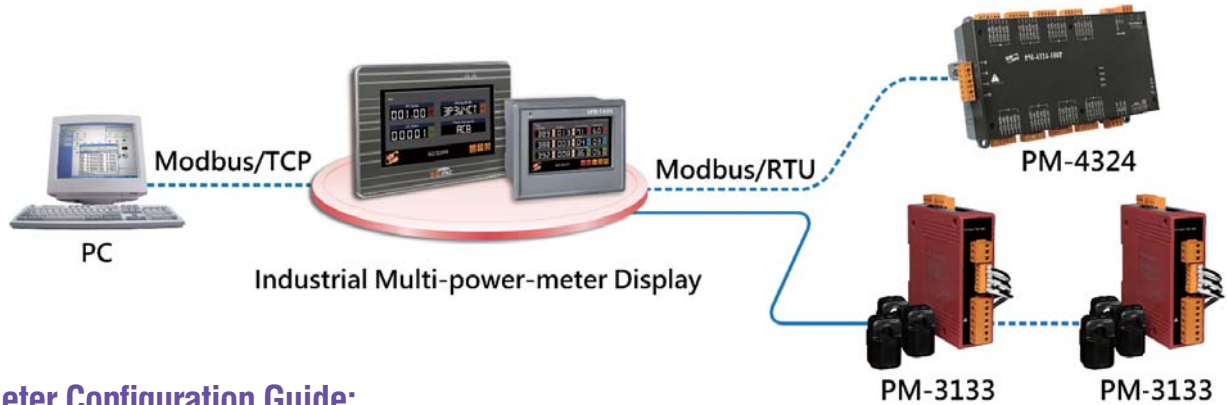

## Meter Configuration Guide:



**Setting Method:**  
Keep clicking on the text or number until it reaches the required value and then press the "Set" button.

## Ordering Information:

Model No.	Description
TPD-433-PM CR	4.3" Industrial Multi-meter TouchPAD, IP40 Waterproof (RoHS)
VPD-143N-PM CR	4.3" Industrial Multi-meter TouchPAD, IP65 Waterproof (RoHS)
TPD-703-PM CR	7" Industrial Multi-meter TouchPAD, IP40 Waterproof (RoHS)
VPD-173-PM CR	7" Industrial Multi-meter TouchPAD, IP65 Waterproof (RoHS)



# DAQ Card

# 9

## Introduction

P 9-1

## 1 PCI Express Data Acquisition Boards

P 9-3

- 1.1. Analog I/O Boards - - - - - P 9-3
- 1.2. Digital I/O Boards- - - - - P 9-4

## 2 PCI Bus Data Acquisition Boards

P 9-5

- 2.1 Multi-Function Boards - - - - - P 9-5
- 2.2 Memory Boards - - - - - P 9-6
- 2.3 Counter/Frequency Board - - - - - P 9-6
- 2.4 Analog Output Boards - - - - - P 9-6
- 2.5 Isolated Digital I/O Boards - - - - - P 9-7
- 2.6 Non-Isolated Digital I/O Boards - - - - - P 9-8

## 3 ISA Bus Data Acquisition Boards

P 9-9



### PC-based I/O Boards Catalog

- PCI Express Data Acquisition Boards
- PCI Bus Data Acquisition Boards
- ISA Bus Data Acquisition Boards
- Special Function Boards
- Daughter Boards and Accessories

Or refer to <http://www.icpdas.com/root/support/catalog/catalog.html>

# Introduction

## 1.1 Presentation

The Data Acquisition boards offer comprises not less than 170 items with ISA, PCI, universal PCI and PCI Express bus interface. For each bus, a wide choice of digital and/or analog input/output boards is available. Digital I/O boards will be used for monitoring and controlling logic signals such as button, on/off switches, relay, high/low and open/close conditions. Whereas Analog I/O boards are for the acquisition of analog signals or transmitting application. Timer, counter and frequency boards are for pulse signals measurements. Our I/O boards are appreciated for their reliability, and can be applied in various fields of automation systems. The use of any Data Acquisition board will be easier with the aid of daughter boards which are highly expandable.

## 1.2 Software

ICPDAS provides SDK and drivers for I/O cards (AD, DA, DI, DO and Timer/Counter series) to support various OS such as Linux, DOS, Windows 98/NT/2000, and 32-/64-bit Windows XP/2003/2008/7/8. Also supports Microsoft's new 32-/64-bit Windows 10. The Windows SDK for I/O cards contain DLL (Dynamic Link Library) file, ActiveX (OCX) control components and several sample programs with source code written in Microsoft Visual C++, Visual Basic, Borland C++ Builder, Delphi, VB.NET, C#.NET and MATLAB. By using the SDK and sample programs, no more complex hardware-register-based operations are required at all, and users can develop their application programs easily and quickly.

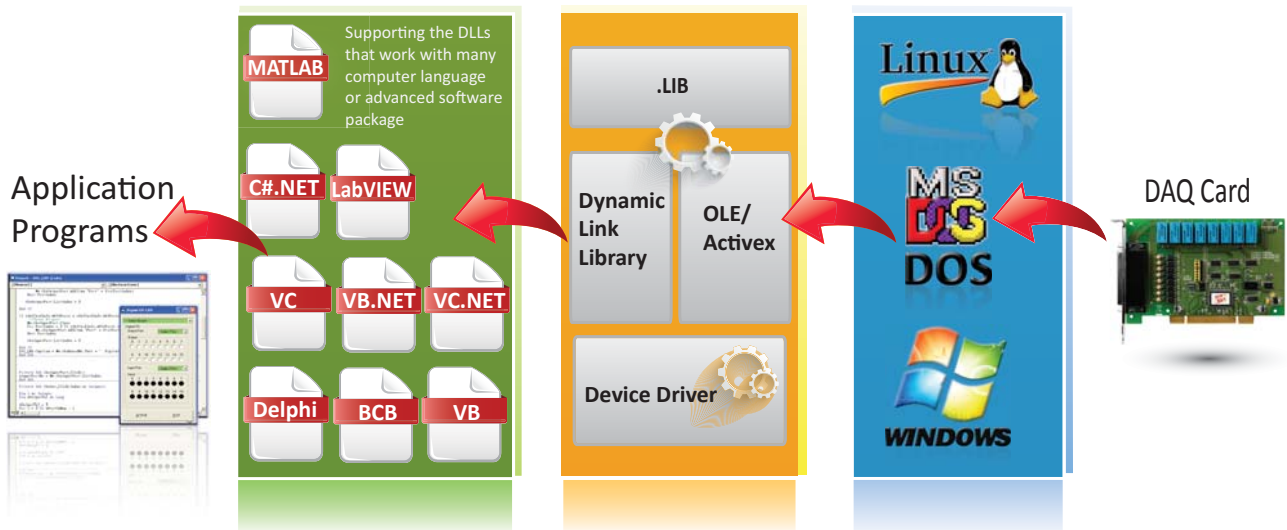

### DOS Lib



DOS has many good features (such as high performance, stability, easy to install and deploy, etc.) for the industrial control and measurement applications.

ICPDAS continuously supports DOS system by providing useful function libraries and lots of C sample programs with source codes. Users can modify or use the sample programs freely.

### Activex Control (OCX)



The OCX is supports Windows 98/NT/2000 and 32-bit Windows XP/2003/2008/7/8/10 and also provides sample programs with source code for VB, VC, Delphi, and BCB, etc. With OCX, users with varied backgrounds and expertise are able to bring their creativity to any kind of application.

### Driver & SDK for Linux



Recently, Linux has been adopted in a lot of industrial applications by many users because of the properties of stability, open source, and free charge.

The I/O cards driver for Linux supports x86 32-bit and 64-bit Linux distributions with Linux Kernel 2.6.x ~ 4.8.x (for examples, Fedora Core, Ubuntu, OpenSUSE, etc.) and the SDK includes libraries and sample programs with source code. Users can develop I/O control applications on Linux easily by the SDK and GNU C Language.

## UniDAQ Driver & SDK for Windows



UniDAQ is a uniform SDK interface working on Windows OS to implement common data access functionality on ICP DAS I/O cards. It supports most I/O cards with PCI/Universal PCI bus and the new coming products with PCI Express bus. With the UniDAQ SDK, it is easy to integrate several different kinds of I/O cards in your system, upgrade to new hardware, expand channels in your system and develop numerous applications based on the various I/O cards.

The UniDAQ SDK includes the Driver, Digital I/O, Interrupt, Analog I/O, Timer/Counter and Memory I/O functions. The UniDAQ SDK supports 32-bit and 64-bit Windows, and also provides sample programs with source code for several programming languages, such as Microsoft Visual C++ 6.0, Microsoft Visual Basic 6.0, Borland Delphi 6.0, Borland C Builder++ 6.0, Microsoft Visual Basic.NET, Microsoft Visual C#.NET, LabVIEW and MATLAB.

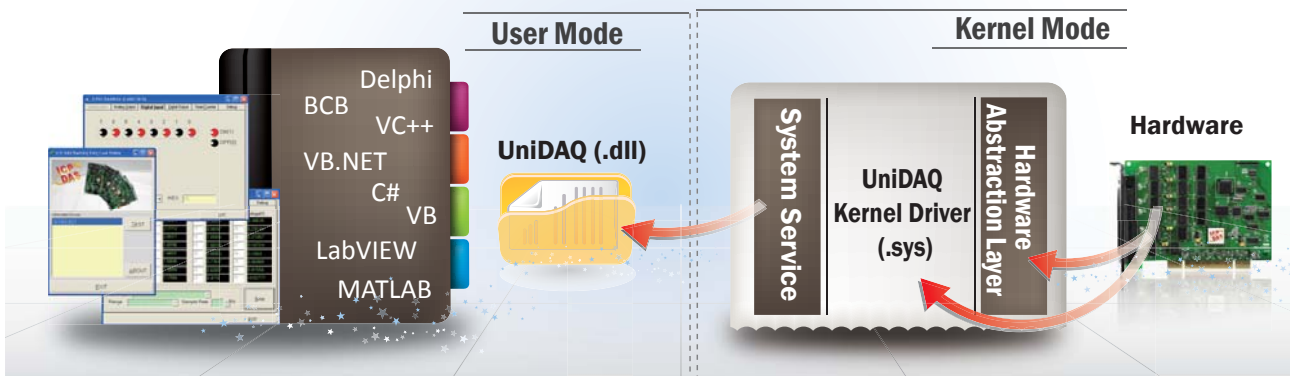

### LabVIEW



ICP DAS provides a LabVIEW toolkit version 7.1 to LabVIEW 2013 for ISA, PCI and PCI Express series cards in the Windows 98/NT/2000 and 32-/64-bit Windows XP/2003/2008/7/8/10. Also provides LLB Library and sample programs with source code.

### DASyLab



ICP DAS develops a series of driver for PCI, ISA and DCON series products. User can easily integrate the hardware and software in the loop of data acquisition, measurement and control system.

### ✔ Suitable User

User situation	UniDAQ Driver & SDK	Classic Driver & SDK
New user (who use the ICP DAS I/O board the first time)	✔	
64-bit Operation System user	✔	
Use several models of the ICP DAS PCI boards	✔	
Original user of the Classic Driver & SDK (User who doesn't want to change the software)		✔
User for Windows 95/98/NT		✔



# 1. PCI Express Data Acquisition Boards

## 1.1 Analog I/O Boards

### Features:

- AI Synchronous Sample & Hold
- 16-bit 200 kHz AD Sampling Rate for all channels
- 2k samples AI FIFO



Full-Height Bracket

Low-Profile Bracket

▲ PCIe-8620

★ Include Low-Profile Bracket

▲ PCIe-8622

### Multifunction and Analog Output Board Selection Guide

Model	NEW PCIe-8620	NEW PCIe-8622	PEX-1202L	PEX-1202H	PEX-1002L	PEX-1002H	PEX-DA4/DA8/DA16
Interface	PCI Express						
<b>Analog Input</b>							
Isolation Voltage	2500 VDC		-	-	-	-	-
Resolution	16-bit		12-bit		12-bit		-
Channels	8 SE	16 SE	32 SE/16 Diff.		32 SE/16 Diff.		-
Sampling Rate	200 kS/s (Per Channel)		110 kS/s	44 kS/s	110 kS/s	44 kS/s	-
Bipolar Input	±5 V, ±10 V	±5 V, ±10 V	±0.625 V, ±1.25 V, ±2.5 V, ±5 V, ±10 V	±0.005 V, ±0.01 V, ±0.05 V, ±0.1 V, ±1 V, ±5 V, ±10 V	±1.25 V, ±2.5 V, ±5 V, ±10 V	±0.01 V, ±0.1 V, ±1 V, ±10 V	-
Unipolar Input	-	-	0 ~ +10 V, 0 ~ +5 V, 0 ~ +2.5 V, 0 ~ +1.25 V	0 ~ +10 V, 0 ~ +0.1 V, 0 ~ +0.01 V	-	-	-
FIFO Size (Samples)	2 K	2 K	1 K		-		-
Accuracy	0.05% of FSR ±1 LSB @ 25°C, ±10 V		0.01% of FSR ±1 LSB @ 25°C, ±10 V		0.01% of FSR ±1 LSB @ 25°C, ±10 V		-
<b>Analog Output</b>							
Resolution	-	16-bit	12-bit		-		14-bit
Channels	-	2	2		-		4/8/16
Accuracy	-	-	0.06% of FSR ±1 LSB @ 25°C, ±10 V		-		0.04% of FSR ±2 LSB @ 25°C, ±10 V
Output Range	-	±5 V, ±10 V	±5 V, ±10 V		-		Voltage: ±10 V Current: 0 ~ +20 mA
Slew Rate	-	2.8 V/μs	8.33 V/μs		-		1.6 V/μs
<b>Non-isolated Digital Input/Output</b>							
DI Channels	-	-	16 (5 V/TTL)		16 (5 V/TTL)		16 (5 V/TTL)
DO Channels	-	-	16 (5 V/TTL)		16 (5 V/TTL)		16 (5 V/TTL)
<b>Isolated Digital Input/Output</b>							
DI Channels	4	12	-		-		-
DO Channels	4	12	-		-		-
Isolation Voltage	2500 VDC	2500 VDC	-		-		-
<b>Timer/Counter</b>							
Channels	-	-	3		3		3
Resolution	-	-	16-bit		16-bit		16-bit
Clock Source	-	-	8 MHz		4 MHz (Internal)		4 MHz (Internal)

# 1.2 Digital I/O Boards

## ✓ PCI Express, Isolated Digital I/O Boards



Model Name	PEX-P8R8i/ PEX-P16R16i	PEX-P8POR8i/ PEX-P16POR16i	PEX-P64		PEX-C64	NEW	NEW	PEX-730/PEX-730A	
			-	-24V		PEX-P32C32	Isolated	Non-Isolated	
Interface	PCI Express								
<b>Digital Input</b>									
Channels	8/16	8/16	64		-	32	16	16	
Isolation Voltage	3750 Vrms	2000 VDC	3750 Vrms		-	3750 Vrms	3750 Vrms		
Compatibility	Photo Coupler	Photo Coupler	Photo Coupler		-	Photo Coupler	Optical	TTL	
Input Voltage	Logic 0	AC/DC 0~1 V		0 ~ 1 V	0 ~ 1 V	-	0 ~ 1 V	0 ~ 1 V	0.8 V Max.
	Logic 1	AC/DC 5 ~ 24		5 ~ 15 V	20 ~ 28 V	-	9 ~ 24 V	9 ~ 24 V	2.0 V min.
Input Impedance	1.2 K $\Omega$ , 0.5 W	1.2 K $\Omega$ , 0.5 W	1.2 K $\Omega$ , 1 W	3 K $\Omega$ , 1 W	-	3 K $\Omega$ , 5 W	1.2 K $\Omega$ , 1 W		
<b>Relay Output</b>									
Channels	8/16	8/16	-		-	-	-		
Relay Type	4 SPDT, 4 SPST/ 8 SPDT, 8 SPST	PhotoMos Relay (Form A)	-		-	-	-		
Contact Rating	AC: 120 V @ 0.5 A DC: 24 V @ 1 A	Load Voltage: 300 V (AC Peak or DC) Load Current: 130 mA	-		-	-	-		
Insulation Resistance	1000 M $\Omega$ @ 500 VDC		-		-	-	-		
<b>Digital Output</b>									
Channels	-	-	-		64	32	16	16	
Isolation Voltage	-	-	-		3750 Vrms	3750 Vrms	3750 Vrms		
Compatibility	-	-	-		Sink (NPN)	Sink (NPN)	Sink (NPN) for PEX-730 Source (PNP) for PEX-730A	5 V/TTL	
Output Capability	-	-	-		100 mA/+30 V for one channel @ 60% duty	100 mA/+30 V for one channel @ 100% duty	100 mA/+30 V for one channel @ 100% duty	Sink: 2.4 mA @ 0.8 V Source: 0.8 mA @ 2.0 V	

## ✓ PCI Express, Non-Isolated Digital I/O Boards



Model Name	PEX-D24	PEX-D48	PEX-D56	NEW	NEW	
				PEX-D96S	PEX-D144LS	
Interface	PCI Express					
<b>Programmable DIO</b>						
Channels	24	48	24	96	144	
<b>Digital Input</b>						
Channels	-	-	16	-	-	
Compatibility	5 V/TTL	5 V/TTL	5 V/TTL	5 V/CMOS	5 V/TTL	
Input Voltage	Logic 0: 0.8 Max. Logic 1: 2.0 min.	Logic 0: 0.8 Max. Logic 1: 2.0 min.	Logic 0: 0.8 Max. Logic 1: 2.0 min.	Logic 0: 0.8 Max. Logic 1: 2.0 min.	Logic 0: 0.8 Max. Logic 1: 2.0 min.	
<b>Digital Output</b>						
Channels	-	-	16	-	-	
Compatibility	5 V/TTL	5 V/TTL	5 V/TTL	5 V/CMOS	5 V/TTL	
Output Voltage	Logic 0: 0.4 V Max. Logic 1: 2.4 V min.	Logic 0: 0.4 V Max. Logic 1: 2.4 V min.	Logic 0: 0.4 V Max. Logic 1: 2.4 V min.	Logic 0: 0.1 V Max. Logic 1: 4.4 V min.	Logic 0: 0.4 V Max. Logic 1: 2.4 V min.	
<b>Timer/Counter</b>						
Channels	-	2	-	-	-	
Resolution	-	16-bit	-	-	-	
Clock Source	-	4 MHz (Internal)	-	-	-	
<b>Connector</b>						
SCSI II 100-pin	-	-	-	1	1	
50-pin Header	-	1	-	-	1	
37-pin D-Sub	1	1	1	-	-	
20-pin Header	-	-	2	-	-	

# 2. PCI Bus Data Acquisition Boards

## 2.1 Multi-Function Boards

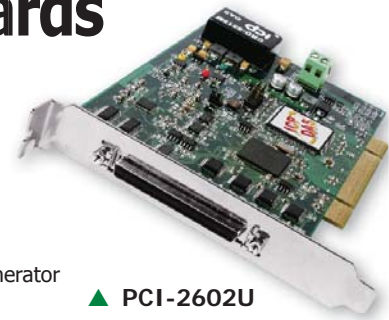

### Features:

- 16 S.E./8 Diff. analog inputs, 8192 samples FIFO
- 16-bit ADC with Max. 1 MS/s sampling rate
- 2-ch 16-bit voltage output
- 32-ch programmable DI/DO
- 8-bit analog/digital pattern generator
- Analog/Digital external trigger

▲ PCI-2602U

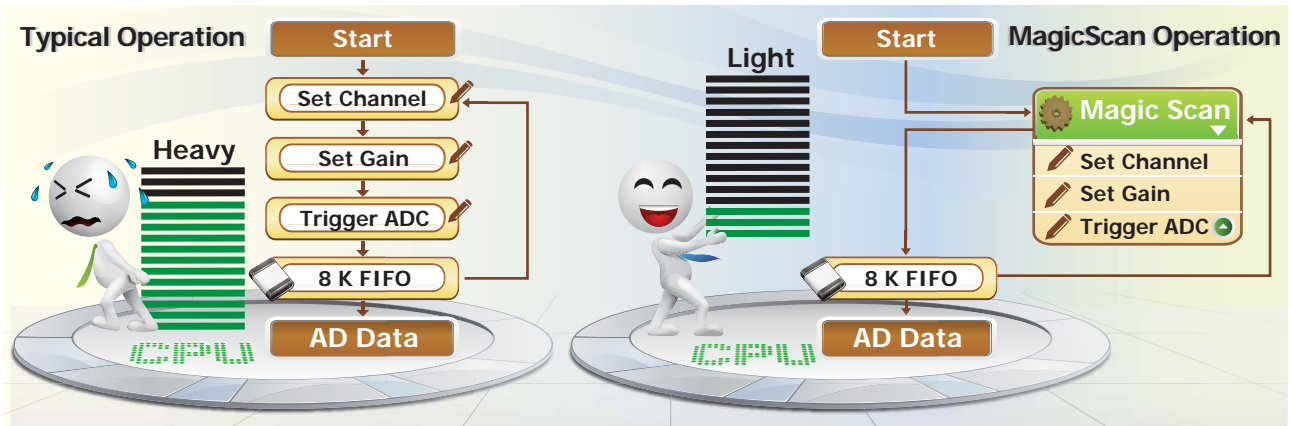

Model	NEW PCI-2602U		PCI-826	PCI-822	PCI-1802		PCI-1800		PCI-1602		PCI-1202		PCI-1002		PIO-821		PISO-813U
	LU	LU	LU	HU	LU	HU	U	FU	LU	HU	LU	HU	LU	HU	LU	HU	
Interface	Universal PCI																
<b>Analog Input</b>																	
Resolution	16-bit	16-bit	12-bit	12-bit	12-bit	12-bit	16-bit	12-bit	12-bit	12-bit	12-bit	12-bit	12-bit	12-bit	12-bit	12-bit	12-bit
Channels	SE	16	32	32	16	32	32	32	32	32	32	32	32	16	32	16	32
	Diif.	8	16	16	8	16	16	16	16	16	16	16	16	8	-	-	-
Sampling Rate	1 MS/s	250 KS/s	330 KS/s	44 KS/s	330 KS/s	44 KS/s	100 KS/s	200 KS/s	110 KS/s	40 KS/s	110 KS/s	44 KS/s	45 KS/s	10 KS/s	10 KS/s	10 KS/s	10 KS/s
FIFO Size (Samples)	8 k	8 k	8 k	1 k	8 k	1 k	-	-	-	-	-	-	-	-	-	-	-
Unipolar Input	-	-	✓	✓	-	✓	✓	✓	✓	✓	✓	✓	✓	✓	✓	✓	✓
Bipolar Input	✓	✓	✓	✓	✓	✓	✓	✓	✓	✓	✓	✓	✓	✓	✓	✓	✓
<b>Analog Output</b>																	
Resolution	16-bit	16-bit	12-bit	12-bit	12-bit	12-bit	12-bit	12-bit	12-bit	12-bit	12-bit	12-bit	12-bit	12-bit	12-bit	12-bit	12-bit
Channels	2	2	2	2	2	2	2	2	2	2	2	2	2	2	2	2	2
Output Voltage	±10 V, ±5 V, ±EXT_REF, 0 ~ +10 V, 0 ~ +5 V, 0~EXT_REF	±5 V, ±10 V, 0 ~ +5 V, 0 ~ +10 V	±5, ±10	±5 V, ±10 V	±5 V, ±10 V	±5 V, ±10 V	±5 V, ±10 V	±5 V, ±10 V	±5 V, ±10 V	±5 V, ±10 V	±5 V, ±10 V	±5 V, ±10 V	±5 V, ±10 V	±5 V, ±10 V	±5 V, ±10 V	±5 V, ±10 V	±5 V, ±10 V
<b>Digital I/O</b>																	
DI Channels	-	-	16	16	16	16	16	16	16	16	16	16	16	16	16	16	16
DO Channels	-	-	16	16	16	16	16	16	16	16	16	16	16	16	16	16	16
Programmable DIO Channels	32	32	-	-	-	-	-	-	-	-	-	-	-	-	-	-	-
Compatibility	DI: 5 V/TTL DO: 5 V/CMOS	5 V/TTL	5 V/TTL	5 V/TTL	5 V/TTL	5 V/TTL	5 V/TTL	5 V/TTL	5 V/TTL	5 V/TTL	5 V/TTL	5 V/TTL	5 V/TTL	5 V/TTL	5 V/TTL	5 V/TTL	5 V/TTL
<b>Timer/Counter</b>																	
Channels	-	-	1	1	1	1	1	1	1	1	1	1	1	1	1	1	1
Resolution	-	-	16-bit	16-bit	16-bit	16-bit	16-bit	16-bit	16-bit	16-bit	16-bit	16-bit	16-bit	16-bit	16-bit	16-bit	16-bit
Clock Source	-	-	8 MHz	8 MHz	8 MHz	8 MHz	8 MHz	8 MHz	8 MHz	8 MHz	8 MHz	8 MHz	8 MHz	4 MHz	2 MHz	2 MHz	2 MHz



## 2.2 Memory Boards

### Features:

- LED indicators for Li-batteries states: normal, low voltage, fault
- Two Li-batteries, BT1 & BT2, for dual battery-backup the data of the SRAM
- On-board 512 KB SRAM
- 16-bit general purpose TTL-compatible D/O
- 12-bit general purpose TTL-compatible D/I (DI 4 ~ 15)
- 4-bit battery status read back (DI 0 ~ 3)
- Universal PCI card, supports both 5 V and 3.3 V PCI bus

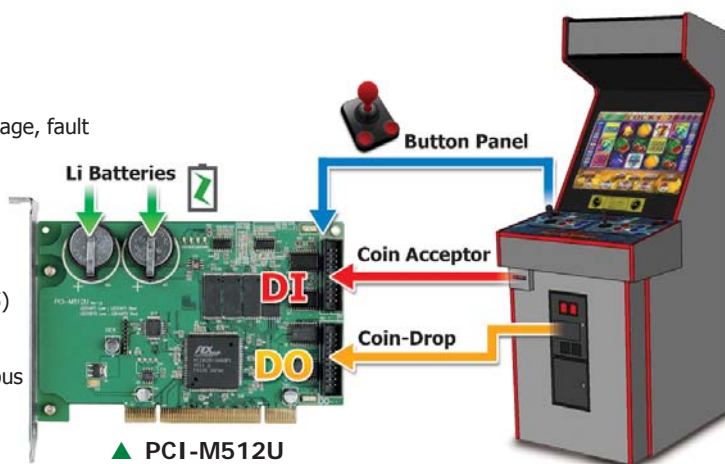

## 2-3 Counter/Frequency Board

### Features:

- Universal PCI Interface supports both the 5 V and the 3.3 V PCI bus
- Supports Card ID (SMD Switch)
- 16-channel Up Counter or Frequency Measurement. (Pulse Width = 2 μs Min.)
- Digital Filter: 1 ~ 32767 (μs)
- 32 Programmable Digital I/O Channels
- Pull-high and Pull-low Resistors for DI Channels
- ±2 kV ESD Protection for each channels



## 2.4 Analog Output Boards

Model Name	PISO-DA2U	PISO-DA4U	PISO-DA8U	PISO-DA16U	PIO-DA4U	PIO-DA8U	PIO-DA16U
Interface	Universal PCI						
<b>Analog Output</b>							
Channels	2	4	8	16	4	8	16
Resolution	12-bit	14-bit	14-bit	14-bit	14-bit	14-bit	14-bit
Isolation Voltage	3750 VDC	2500 VDC	2500 VDC	2500 VDC	-	-	-
Isolation Type	Bus Type, CH-to-CH	Bus Type	Bus Type	Bus Type	-	-	-
Built-in DC/DC Converter	3000 VDC	3000 VDC	3000 VDC	3000 VDC	-	-	-
Output Voltage	±5 V ±10 V 0 ~ 5 V 0 ~ 10 V	±10 V	±10 V	±10 V	±10 V	±10 V	±10 V
Output Current	0 ~ 20 mA 4 ~ 20 mA	0 ~ 20 mA	0 ~ 20 mA	0 ~ 20 mA	0 ~ 20 mA	0 ~ 20 mA	0 ~ 20 mA
Output Driving	±5 mA	±5 mA	±5 mA	±5 mA	±5 mA	±5 mA	±5 mA
<b>Digital I/O</b>							
DI Channels	-	16	16	16	16	16	16
DO Channels	-	16	16	16	16	16	16
Compatibility	-	5 V/TTL	5 V/TTL	5 V/TTL	5 V/TTL	5 V/TTL	5 V/TTL
<b>Timer/Counter</b>							
Channels	-	3	3	3	3	3	3
Resolution	-	16-bit	16-bit	16-bit	16-bit	16-bit	16-bit
Clock Source	-	4 MHz	4 MHz	4 MHz	4 MHz	4 MHz	4 MHz

## 2.5 Isolated Digital I/O Boards

Model	PISO-1730U	PISO-P32C32U		PISO-P32A32U		PISO-P32S32WU	PISO-P64U		PISO-C64U	PISO-A64	PISO-730		PISO-730A	
		-	-5V	-	-5V		-	-24V				U	-5V	-
Interface	Universal PCI					Universal PCI				PCI	Universal PCI	PCI		
<b>Isolated Digital Input</b>														
Channels	32	32		32		32	64		-	-	16		16	
Isolation Voltage	3750 Vrms								-	-	3750 Vrms			
Input Voltage	Logic 0	0 ~ +1 V												
	Logic 1	+9 ~ +24 V	+5 ~ +12 V	+9 ~ +24 V	+5 ~ +12 V	+9 ~ +24 V	+5 ~ +15 V	+20 ~ +28 V	-	-	+9 ~ +24 V	+5 ~ +12 V	+9 ~ +24 V	+5 ~ +12 V
Input Impedance	3 K $\Omega$ , 0.5 W					1.2 K $\Omega$ , 1 W		3 K $\Omega$ , 1 W	-	-	1.2 K $\Omega$ , 1 W			
Built-in DC/DC Converter	3000 VDC				-	3000 VDC			-	-	3000 VDC		-	
<b>Isolated Digital Output</b>														
Channels	32	32		32		32	-		64	64	16		16	
Type	Sink (NPN)			Source (PNP)		Sink (NPN)	-		Sink (NPN)	Source (PNP)	Sink (NPN)		Source (PNP)	
Isolated Voltage	3750 Vrms					-		3750 Vrms						
Output Range	100 mA/+30 V for each channel @ 100% duty				500 mA (Max.)		-		100 mA/+30 V for each channel @ 60% duty		100 mA/+30 V for each channel @ 100% duty			
<b>Non-isolated Digital I/O</b>														
DI Channels	-	-		-		-	-		-	-	16		16	
DO Channels	-	-		-		-	-		-	-	16		16	
Compatibility	-	-		-		-	-		-	-	5 V/TTL		5 V/TTL	

Model	PCI-P8R8U	PCI-P16R16U	PCI-P16C16	PCI-P16POR16U	PISO-P8R8U	PISO-P8SSR8AC	PISO-P8SSR8DC	PISO-P16R16U	PISO-725	
	Interface	Universal PCI		PCI	Universal PCI	Universal PCI	PCI		Universal PCI	PCI
<b>Isolated Digital Input</b>										
Channels	8 (Optical)	16 (Optical)	16 (Optical)	16 (Optical)	8 (Optical)	8 (Optical)	8 (Optical)	16 (Optical)	8 (Optical)	
Isolation Voltage	5000 Vrms							3750 Vrms		
Input Voltage	Logic 0	AC/DC 0 ~ +1 V								
	Logic 1	AC/DC +5 ~ +24 V (AC 50 ~ 1 kHz)								
<b>Isolated Digital Output</b>										
Channels	4 $\times$ Form C 4 $\times$ Form A	8 $\times$ Form C 8 $\times$ Form A	16 (Sink, NPN)	16 $\times$ Form A	8 $\times$ Form A	8 $\times$ Form A	8 $\times$ Form A	8 $\times$ Form C 8 $\times$ Form A	8 $\times$ Form C	
Type	Relay	Relay	Open-collector	PhotoMos Relay	Relay	AC Type Solid-state Relay	DC Type Solid-state Relay	Relay	Relay	
Isolated Voltage	-	-	5000 Vrms	-	-	-	-	-	-	
Contact Rating	DC	24 V @ 1 A		Load Voltage: 300 V (AC Peak or DC)	30 V @ 5 A		3 ~ 30 V		24 V @ 1 A	1 A/30 V
	AC	120 V @ 0.5 A			250 V @ 1.6 A		24 ~ 265 V		120 V @ 0.5 A	

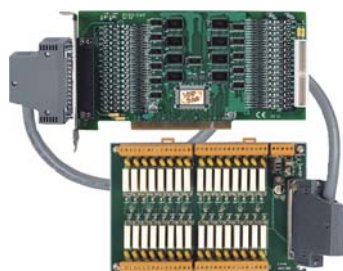

**PISO-C64 with DB-32R:**  
32-ch relay (3A, Form A) board, 1m cable.



**PISO-P64 with DN-37:**  
D-sub 37-pin daughter board with 1 m cable.



**PISO-P32C32 with DB-16P16R:**  
16-ch input terminal and 16-ch Relay (3A, Form A) board, 1 m cable.

## 2.6 Non-Isolated Digital I/O Boards

### SCSI-II Cabling

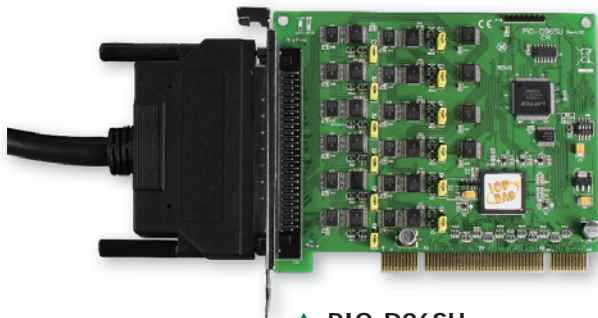

▲ PIO-D96SU

### Classic Cabling



▲ PIO-D96U

Model Name	PCI-D64HU	PIO-D24U	PIO-D48U	NEW PIO-D48SU	PIO-D56U	PIO-D64U	PIO-D96U	NEW PIO-D96SU	PIO-D144U	NEW PIO-D144LU	PIO-D168U	PCI-TM C12AU
Interface	Universal PCI											
<b>Programmable DIO</b>												
Channels	-	24	48	24	-	96	144	168	-	-	-	-
<b>Digital Input</b>												
Channels	32	-	-	16	32	-	-	-	-	-	-	16
Compatibility	5 V/TTL						5 V/CMOS	5 V/TTL	5 V/CMOS	5 V/TTL		
Input Voltage	Logic 0	0.8 V Max.										
	Logic 1	2.0 V min.										
<b>Digital Output</b>												
Channels	32	-	-	16	32	-	-	-	-	-	-	16
Compatibility	5 V/TTL						5 V/CMOS	5 V/TTL	5 V/CMOS	5 V/TTL		
Output Voltage	Logic 0	0.55 V Max.	0.4 V Max.				0.1 V Max.	0.4 V Max.	0.1 V Max.	0.4 V Max.		
	Logic 1	2.0 V min.	2.4 V Max.				4.4 V min.	2.4 V Max.	4.4 V min.	2.4 V Max.		
Output Capability	Sink	64 mA @ 0.55 V	64 mA @ 0.8 V	64 mA @ 0.8 V	CN1: 2.4 mA @ 0.8 V CN3: 64 mA @ 0.8 V	24 mA @ 0.8 V	64 mA @ 0.8 V	6 mA @ 0.33 V	64 mA @ 0.8 V	6 mA @ 0.33 V	64 mA @ 0.8 V	24 mA @ 0.8 V
	Source	-32 mA @ 2.0 V	32 mA @ 2.0 V	32 mA @ 2.0 V	CN1: 0.8 mA @ 2.0 V CN3: 32 mA @ 2.0 V	15 mA @ 2.0 V	32 mA @ 2.0 V	6 mA @ 4.77 V	32 mA @ 2.0 V	6 mA @ 4.77 V	32 mA @ 2.0 V	15 mA @ 2.0 V
<b>Timer/Counter</b>												
Channels	3	-	2	-	6	-	-	-	-	-	-	12
Resolution	16-bit	-	16-bit	-	16-bit	-	-	-	-	-	-	16-bit
Clock Source	-	-	4 MHz	-	4 MHz	-	-	-	-	-	-	8 MHz
<b>Connector</b>												
SCSI II 100-pin	-	-	-	1	-	-	-	1	-	-	-	-
50-pin Header	-	-	1	-	-	-	3	-	5	5	6	-
40-pin Header	1	-	-	-	-	-	-	-	-	-	-	-
37-pin D-Sub	1	1	1	-	1	-	1	-	1	1	1	1
20-pin Header	-	-	-	-	2	5	-	-	-	-	-	2



# 3. ISA Bus Data Acquisition Boards

## ✓ Multifunction Board Selection Guide



Model	A-826PG	A-823PGL A-823PGH	A-822PGL A-822PGH	A-821PGL A-821PGH	A-812PG	A-8111
Interface	ISA Bus					
<b>Analog Input</b>						
Channels	16 SE/ 8 Diff.	16 SE/ 8 Diff.	16 SE/ 8 Diff.	16 SE/ 8 Diff.	16 S.E.	8 S.E.
Resolution	16-bit	12-bit	12-bit	12-bit	12-bit	12-bit
Sampling Rate	100 kS/s	125 kS/s	125 kS/s	45 kS/s	62.5 kS/s	35 kS/s
<b>Analog Output</b>						
Channels	2	2	2	1	2	1
Resolution	12-bit	12-bit	12-bit	12-bit	12-bit	12-bit
<b>Digital I/O (5 V/TTL)</b>						
DI Channels	16	16	16	16	16	16
DO Channels	16	16	16	16	16	16
<b>Timer/Counter</b>						
Channels	3	3	3	3	3	3

## ✓ Isolated Data Acquisition Board Selection Guide



Model	ISO-AD32		ISO-813	ISA-DA		Model	ISO-P64	ISO-C64	ISO-P32C32	ISO-P32S32W	ISO-730	P8R8 DIO	P16R16 DIO		
	L	H		8	16										
Interface	ISA Bus														
<b>Analog Input</b>															
Channels	32 SE/ 16 Diff.		32 SE		-	Channels	64	-	32	32	16	8	16		
Resolution	12-bit		12-bit		-	Isolation Voltage	3750 Vrms	-	3750 Vrms	3750 Vrms	3750 Vrms	5000 Vrms			
Sampling Rate	200 kS/s		10 kS/s		-	Input Voltage	9 ~ 24 V	-	9 ~ 24 V	5 ~ 24 V	9 ~ 24 V	5 ~ 24 V			
Isolation Voltage	500 Vrms		3000 Vrms		-	<b>Isolated Digital Output</b>									
FIFO Size	1 kB		-		-	Channels	-	64	32	32	16	8	16		
<b>Analog Output</b>															
Channels	-	-	-	8	16	Isolated Voltage	-	3750 Vrms	3750 Vrms	3750 Vrms	3750 Vrms	-			
Isolated Voltage	-	-	-	2500 VDC		Compatibility	-	Sink	Sink	Sink	Sink	-			
Resolution	-	-	-	14-bit		Relay Type	-	-	-	-	-	4 SPDT, 4 SPST	8 SPDT, 8 SPST		
Output Range	-	-	-	±10 V, 0~+20 mA		<b>Digital I/O (5 V/TTL)</b>									
<b>Digital I/O (5 V/TTL)</b>															
DI Channels	-	-	-	-	-	DI Channels	-	-	-	-	16	-	-		
<b>Timer/Counter</b>															
DO Channels	-	-	-	-	-	DO Channels	-	-	-	-	16	-	-		
Channels	-	-	-	-	-	Programmable DI/O	-	-	-	24	48	-	96	144	-
<b>Timer/Counter</b>															
Channels	-	-	-	-	-	Channels	-	-	3	3	6	-	-	-	10

## ✓ Non-isolated Data Acquisition Board Selection Guide



Model	A-726	A-626	A-628	DIO-24	DIO-48	DIO-64/3	DIO-64/6	DIO-96	DIO-144	TMC-10
Interface	ISA Bus									
<b>Analog Output</b>										
Channels	6	6	8	-	-	-	-	-	-	-
Resolution	12-bit	12-bit	12-bit	-	-	-	-	-	-	-
<b>Digital I/O (5 V/TTL)</b>										
DI Channels	16	16	16	-	-	32	-	-	-	8
DO Channels	16	16	16	-	-	32	-	-	-	8
Programmable DI/O	-	-	-	24	48	-	-	96	144	-
<b>Timer/Counter</b>										
Channels	-	-	-	-	3	3	6	-	-	10

# Accessories

# 10

- 1 Signal Conditioning Modules (SG-3000 Series) P 10-1
- 2 3-channel DC Current Signal Splitter P 10-2
- 3 EMI Ferrite Split/Snap-On Core P 10-2
- 4 Surge Protection Module (SG-770) P 10-3
- 5 Relay Modules P 10-4
- 6 Enclosures and Mounting Kit P 10-5
- 7 MISC P 10-6



# 1. Signal Conditioning Modules (SG-3000 Series)

## Introduction:

SG-3000 series signal conditioning modules are used to accept wide range of input signals, such as voltage, current, temperature (thermocouple and RTD) and provide 0 ~ 10 VDC , 0 ~ 20 mA, 4 ~ 20 mA output signals.

It gives following good features for industrial applications

- 3-way (power/input/output) isolation (1000 Vdc)
- Wide operating temperature (-25 ~ +75°C)
- DIN-Rail mounting
- Input and output connectors on the opposite side
- Signal range configurable by switch

## Applications:

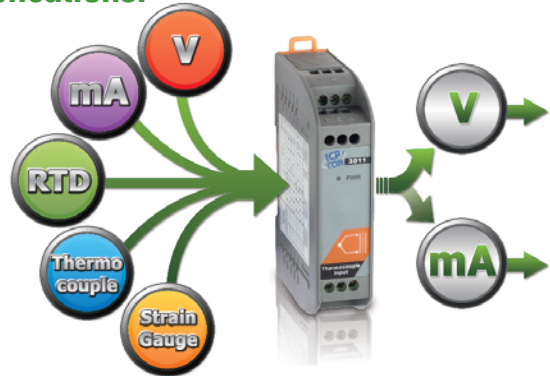

## Description:

Analog Conditioning Modules					
Models	SG-3011H	SG-3013	SG-3016	SG-3071	SG-3081
Pictures					
<b>Analog Input</b>					
Channel	1	1	1	1	1
Wiring	Differential	2/3/4 wires	Differential	Differential	Differential
Signal	Thermocouple	RTD	Strain Gauge	Voltage	Current
Type	Type J, K, T, E, R, S, B, N, C, L, M, L2	Pt100 $\alpha=0.00385$ , Pt100 $\alpha=0.003916$ , Ni 120, Pt1000 $\alpha=0.00385$	$\pm 10$ mV, $\pm 20$ mV, $\pm 30$ mV, $\pm 50$ mV, $\pm 100$ mV	$\pm 5$ V, $\pm 10$ V	0 ~ 20 mA, 4 ~ 20 mA
Bandwidth	-	-	600 Hz	1 KHz	1 KHz
Response Time	0.5 ms or 100 ms by switch selectable	100 ms	-	-	-
Accuracy	$\pm 0.1\%$ of FSR	$\pm 0.1\%$ of FSR	$\pm 0.1\%$ of FSR	$\pm 0.1\%$ of FSR	$\pm 0.1\%$ of FSR
Input Impedance	1.6 M $\Omega$	-	-	1.6 M $\Omega$	250 $\Omega$
Excitation Voltage	-	-	0 ~ 10 V	-	-
<b>Analog Output</b>					
Channel	1	1	1	1	1
Current Output	0 ~ 20 mA	0 ~ 20 mA, 4 ~ 20 mA	0 ~ 20 mA	0 ~ 20 mA, 4 ~ 20 mA	0 ~ 20 mA, 4 ~ 20 mA
Voltage output	0 ~ 10 V	0 ~ 5 V, 0 ~ 10 V	$\pm 5$ V, $\pm 10$ V, 0 ~ 5 V, 0 ~ 10 V	$\pm 5$ V, $\pm 10$ V	0 ~ 5 V, 0 ~ 10 V
<b>System</b>					
3-way Isolation	1000 VDC				
Power Input	10 ~ 30 VDC				
Power Consumption	1.44 W	1.2 W	1.44 W	1.8 W	1.61 W
Operating Temperature	-25 ~ +75°C				
Dimensions (W x H x D)	25 mm x 114 mm x 71 mm				

Power Conditioning Modules				
Models	PW-3090-24S	PW-3090-12S	PW-3090-5S	PW-3090-4824S-10
Pictures				
Input	18 ~ 36 V (non-regulated)	18 ~ 36 V (non-regulated)	18 ~ 36 V (non-regulated)	36 ~ 72 V (non-regulated)
Output	24 V @ 0.4 A (Max.)	12 V @ 0.8 A (Max.)	5 V @ 2 A (Max.)	24 V @ 0.4 A (Max.)
Isolation	1000 VDC			
Efficiency	83% Typical			
Operating Temperature	-25 ~ +75°C			
Dimensions (W x H x D)	25 mm x 114 mm x 71 mm			



## 2. 3-channel DC Current Signal Splitter



SG-3383

### Introduction:

The SG-3383 DC current signal splitters accept one 4 to 20 mA current input and provide three optically isolated 4 to 20 mA current outputs that are linearly related to the 4 to 20 mA current input. This provides an economical solution when one signal must be sent to three different devices. Typical applications include isolation, output splitting, output device separation and redundancy (i.e. to prevent failure of the entire loop if one device fails), or a combination of these. The input signal is filtered, amplified, split, and then passed through an opto-coupler to the output stages. Full 3-way isolation (input, output, power), 4 kV EFT Protection for Power Line and 8 kV ESD Protection make this module useful for ground loop elimination, common mode signal rejection, and noise pickup reduction.

The SG-3383 includes an LED display that can be used to indicate whether the module is functioning correctly, and also includes VRs (Zero, Span) that can be used to calibrate the output range accuracy. The input bandwidth of the SG-3383 is typically 2.5 kHz.

### Features:

- One 4 to 20 mA Input to Three 4 to 20 mA Outputs
- Zero and Span Adjustments for Each Output
- Full 3000 V Isolation for Input/Output/Power
- Built-In Loop Power Supplies for Sink/Source I/O
- Split, Convert, Boost, and Rescale Process Signals
- Split Process Signals for Control and Validation
- Interface a Process Signal with Multiple Panel Meters, PLCs, Recorders, Data Acquisition, DCS, and SCADA Systems
- 8 kV ESD Protection
- 4 kV EFT Protection for Power Line
- Flexible DIN-Rail Mounting
- Wide Operating Temperature Range: -25 to +75°C

### Applications:

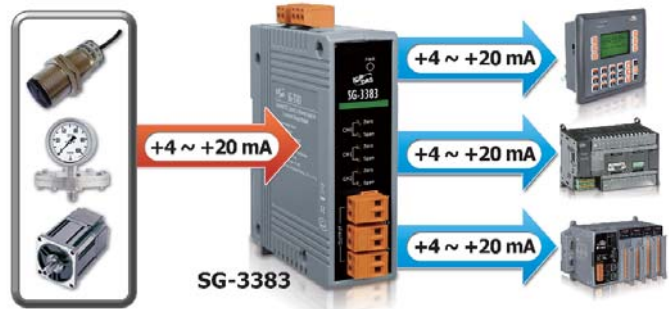

## 3. EMI Ferrite Split/Snap-On Core



4PCD-002

### Introduction:

The split ferrite cable cores are designed to significantly reduce EMI/RFI for round cables. The hinged plastic case surrounding the split core is designed to clamp onto the cable to provide a secure fixture of the ferrite onto the cable. The cores can be retrofitted onto existing installations or used in post-assembly operations on the data and power cables of electronic equipment.

### Applications:

RS-232, RS-422, RS-485, CAN bus, FRnet, PROFIBUS, Ethernet, USB, AC/DC Power line..etc

### Features:

- Aimed to suppress low frequency noise generated by engine control units, inverters, and motors
- Max. Cable Diameter Ø15 mm
- Operation Temperature: -25 ~ 75°C

### Installation:



# 4. Surge Protection Module (SG-770)



**SG-770**

### Features:

- IEC 61000-4-5, IEC 61000-4-12
- 6 kV Surge Protection
- RoHS Compliance
- A Wide Range of Operating Temperature: -25 ~ +75°C
- Easy Wiring

### Introduction:

SG-770 offers 7 differential or 14 single-ended for surge protection. SG-770 is approved with IEC 61000-4-5 and IEC 61000-4-12 standards. Each of channels supports 0 ~ ±30 VDC signal and each of channels is protected for surge achieves 6 kV.

### Applications:

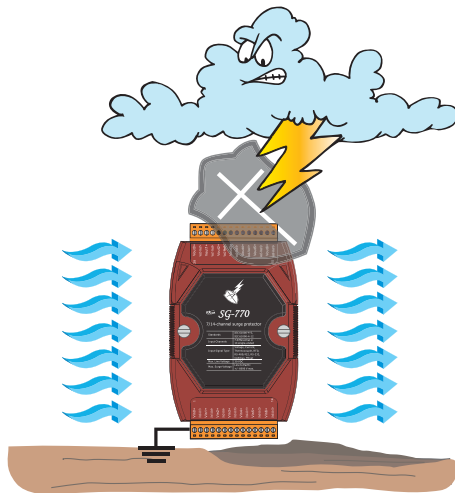

### Pin Assignments:

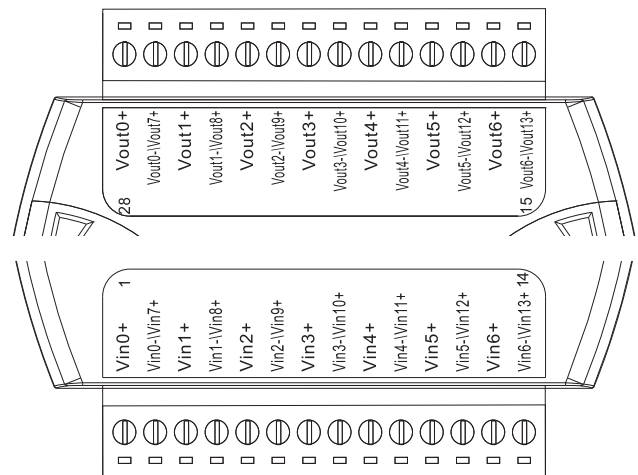



### Specifications:



Models	SG-770
<b>General</b>	
Input Channels	7 differential or 14 single-ended
Input Signal Type	Voltage, Current, Thermocouple, RTD, RS-485/RS-422/RS-232, CAN
Max. Line Voltage	30 Vdc
<b>Surge Protection Performance</b>	
Standard	IEC 61000-4-5 IEC 61000-4-12
Max. Surge Voltage	Line to Earth: ±6000 VDC Max.
<b>Environment</b>	
Operating Temperature	-25 ~ +75°C
Storage Temperature	-30 ~ +75°C
Humidity	5 ~ 95% RH, Non-condensing
Dimensions (W × H × D)	123 mm × 72 mm × 33 mm







### Ordering Information:

Model No.	Description
SG-770 CR	7 channel differential or 14 channel single-ended surge protector (RoHS)

# 5. Relay Modules

Models	DN-PR4	RM-104, RM-108, RM-116	RM-204, RM-208, RM-216
Pictures			
Relay	VE-24H5-K	FINDER - 40.61.7.024.0000	FINDER - 44.52.7.024.0000
Type	Power Relay		
Channel	4	RM-104: 4 channels RM-108: 8 channels RM-116: 16 channels	RM-204: 4 channels RM-208: 8 channels RM-216: 16 channels
Contact	Form C	Form C (SPDT)	Form C (DPDT)
Operating Voltage Range	250 VAC / 30 VDC	250 VAC	250 VAC
Max. Load Current	5 A	16 A	6 A
Operate Time	10 ms (Typical)	7 ms (Typical)	8 ms (Typical)
Release Time	5 ms (Typical)	3 ms (Typical)	5 ms (Typical)
LED Indicator	Yes (for Relay status)		
<b>Mechanical</b>			
Dimensions (W × L × D)	96 mm × 103 mm × 34 mm	RM-104: 79 mm × 87 mm × 63 mm RM-108: 135 mm × 87 mm × 63 mm RM-116: 270 mm × 87 mm × 63 mm	RM-204: 90 mm × 87 mm × 63 mm RM-208: 169 mm × 87 mm × 63 mm RM-216: 327 mm × 87 mm × 63 mm
Installation	DIN-Rail Mounting		

Models	DN-SSR4	DN-SSR4DC
Pictures		
Relay	A5P-204U	D3P-054
Type	Solid-State Relay	
Channel	4 channels	
Contact	Form A (SPST)	
Operating Voltage Range	250 VAC / 30 VDC	50 VDC
Max. Load Current	4 A	
Operate Time	1/2 Cycle + 1 ms and below	0.5 ms and below (Resistance load)
Release Time	1/2 Cycle + 1 ms and below	0.5 ms and below (Resistance load)
LED Indicator	Yes (for Relay status)	
<b>Mechanical</b>		
Dimensions (W × L × D)	101 mm × 77 mm × 66 mm	
Installation	DIN-Rail Mounting	

Models	RM-20.22	RM-22.22	RM-38.61	RM-48.61	RM-48.62
Pictures					
Relay	Finder 20.22.9.024.4000	Finder 22.22.9.024.4000	Finder 34.51.7.024.0010	FINDER - 40.61.7.024.0000	FINDER - 44.62.7.024.0000
Type	Step Relay		Power Relay		
Channel	1				
Contact	Form A (DPST)	Form A (DPST)	Form C (SPDT)	Form C (SPDT)	Form C (SPDT)
Operating Voltage Range	230 VAC	230 VAC	250 VAC	250 VAC	250 VAC
Max. Load Current	16 A	20 A	6 A	16 A	10 A
Operate Time	15 ms	15 ms	5 ms	7 ms	7 ms
Release Time	8 ms	8 ms	3 ms	3 ms	3 ms
LED Indicator	-				
<b>Mechanical</b>					
Dimensions (W × L × D)	17.5 mm × 84 mm × 62.7 mm		76.5 mm × 6.5 mm × 89 mm	75 mm × 15.5 mm × 78.5 mm	
Installation	DIN-Rail Mounting				
<b>Note1:</b>	RM-38.61: 5 pcs in one package RM-48.61: 4 pcs in one package RM-48.62: 4 pcs in one package				
<b>Note2:</b>	RM-38-093.20 is a 20-way jumper link for RM-38.61				
					
					



# 6. Enclosures and Mounting Kit



## Specifications:

Models	I-3625-ENC	I-25091-ENC	I-25140-ENC	I-25166-ENC
<b>Includes</b>				
	Case Accessory			
	2 × Polyamide cable glands	2 × cable glands: 4PASO-0028 (Cable Range $\Phi 9 \sim 14$ mm) 1 × cable glands: 4SASO-0007 (Cable Range $\Phi 7 \sim 4$ mm)		
	6 × captive lid screws	4 × captive lid screws		
	1 × DIN-Rail (35.8 cm)	1 × DIN-Rail (20 cm)		
<b>Mechanical</b>				
Casing	Plastic			
Dimensions (W × H × D)	360 mm × 254 mm × 165 mm	255 mm × 181 mm × 91 mm	255 mm × 181 mm × 140 mm	255 mm × 181 mm × 166 mm
<b>Environmental</b>				
Temperature	0 ~ +50°C for Protection rating IP66			



## RK-3UD-R

19" Rack Mounting Kit, 3U



## Specifications:

Mechanical	
Dimensions (W × H × D)	481 mm × 132 mm × 125 mm



## BX-ENEL5-1

## Battery box:

Battery box for Nikon EN-EL5 type of battery with DIN rail mounting kit and one 15 cm length cable.

# 7. MISC



## I-7560U

USB to RS-232 Converter



### Specifications:

Interface	
USB	Fully Compliant with the USB 1.1/2.0/3.0
RS-232	TxD, Rx D, RTS, CTS, DSR, DTR, DCD, RI and GND; non-isolated
Baud Rate	300 bps ~ 921.6 kbps
Driver	Windows 98/ME/2000/XP/Vista (32/64-bit)/7 (32/64-bit)/8 (32/64-bit)/8.1 (32/64-bit)/Linux
Mechanical	
Dimensions (W × H × D)	33 mm × 60 mm × 15 mm
Environmental	
Operating Temperature	-25 ~ +75°C
Storage Temperature	-30 ~ +75°C

### Ordering Information:

<b>I-7560U CR</b>	USB to RS-232 Converter, includes one 1.8 m cable (RoHS)
-------------------	--



## I-7561U

USB to RS-232/422/485 Converter



### Specifications:

Interface	
USB	Fully Compliant with the USB 1.1/2.0/3.0
Serial Interface	RS-232: TxD, Rx D, GND
	RS-422: TxD+, TxD-, Rx D+, Rx D-
	RS-485: Data+, Data-
Baud Rate	300 bps ~ 921.6 kbps
Driver	Windows 98/ME/2000/XP/Vista (32/64-bit)/7 (32/64-bit)/8 (32/64-bit)/8.1 (32/64-bit)/Linux
Mechanical	
Dimensions (W × H × D)	72 mm × 115 mm × 35 mm
Environmental	
Operating Temperature	-25 ~ +75°C
Storage Temperature	-30 ~ +75°C

### Ordering Information:

<b>I-7561U CR</b>	USB to RS-232/422/485 converter, includes one 1.8 m cable (RoHS)
-------------------	--



## USB-2020

USB Audio Device



### Specifications:

Interface	
Output Channels	Mono, Stereo (L + R)
Input Channels	Mono, Stereo (L + R)
Button	HID volume up, volume down and Mute
Input Voltage Range	+10 ~ +30 VDC
Mechanical	
Dimensions (W × H × D)	33 mm × 107 mm × 78 mm
Environmental	
Operating Temperature	-25 ~ +75°C
Storage Temperature	-40 ~ +85°C

### Ordering Information:

<b>USB-2020 CR</b>	USB Audio Device (RoHS)
--------------------	-------------------------



## USB-2560

4-Port Industrial USB 2.0 Hub



### Specifications:

Interface	
Ports	Upstream × 1 (Type B); Downstream × 4 (Type A)
Compatibility	Specification Rev. 2.0/1.1/1.0
Transfer Speed	480 Mbit/s-high speed mode
Input Voltage Range	+10 ~ +30 VDC
Mechanical	
Dimensions (W × H × D)	33 mm × 107 mm × 78 mm
Environmental	
Operating Temperature	0 ~ +70°C
Storage Temperature	-20 ~ +80°C

### Ordering Information:

<b>USB-2560 CR</b>	4-port Industrial USB 2.0 Hub (RoHS)
<b>USB-2560/S CR</b>	4-port Industrial USB 2.0 Hub (RoHS) with GPSU06U-6 (Power Supply)



# ICP DAS Catalogs & Brochure

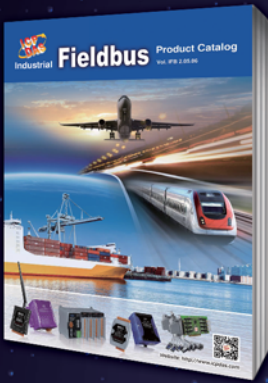

## Industrial Fieldbus

- RS-485
- Industrial Ethernet
- Profinet
- CAN bus
- CANopen
- Devicenet
- J1939
- PROFIBUS
- HART
- Ethernet/IP
- BACnet



## Acquisition and Control I/O Products for PC-based Systems

- PCI Express Bus Data Acquisition Boards
- PCI Bus Data Acquisition Boards
- ISA Bus Data Acquisition Boards



## Energy Management Solution

- InduSofftt SCADA Soffttwarre
- Smart Power Meter Concentrator
- Smart Power Meter
- True RMS Input Module
- TouchPAD Devices - VPD Series



## WISE Product Line Smart Front-end for Industrial IoT

- WISE - IIoT Concentrator
- WISE - WISE I/O Module
- WISE-52XX - IIoT Concentrator
- WISE-58XX - WISE I/O Module
- WISE-71XX - WISE I/O Module
- WISE-75XXM - WISE I/O Module



## Machine Automation

- Motionnet Solutions
- EtherCAT Motion Control Solutions
- Ethernet Motion Control Solutions
- Serial Communication Motion Control Solutions
- PC-based Motion Control Cards
- PAC Solutions - Motion Modules

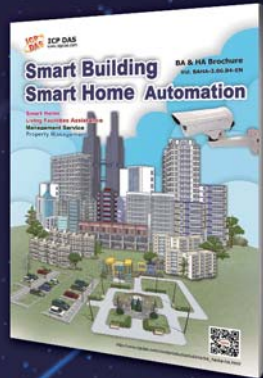

## Smart Building, Smart Home Automation

- Video Intercom & Access Control
- Touch HMI - TouchPAD Series
- Smart Lighting Control
- Energy Saving - PM/PMC Series
- Environmental - DL/CL Series
- Motion Detector - PIR/RPIR Series
- Wi-Fi Wireless - WF Series
- Infrared Wireless - IR Series
- ZigBee Wireless - ZT Series
- IIoT Server & Concentrator
- Data Server - iDaSer Series
- LED Display - iKAN Series



## TuchPAD HMI Solutions

- Introduction
- TPD/VPD Products Series
- Video Intercom & Access Control Series
- TPD/VPD Application



## Remote I/O Modules and I/O Expansion Units Products Catalog

- RS-485 Products
- Ethernet Remote I/O Modules
- FRnet I/O Modules
- CAN Bus Products
- PROFIBUS Remote I/O Modules
- HART Products
- Smart Power Meter
- WISE I/O Module



**ICP DAS CO., LTD.**

**Taiwan (Headquarters)**

Website: <http://www.icpdas.com>

TEL: +886-3-597-3366

FAX: +886-3-597-3733

E-mail: [info@icpdas.com](mailto:info@icpdas.com)

[sales@icpdas.com](mailto:sales@icpdas.com)



**Local Distributor**