



Industrial Communication Product Brochure

www.icpdas.com

Vol. ICPC 1.07.03



CAN-Log 200

CAN1 CAN2

Power RS RS_ST

CAN1 CAN2 CAN_ST

Model	Port	Speed	Protocol
1	1	125Kbps	CAN
2	2	125Kbps	CAN
3	1	125Kbps	RS-485
4	2	125Kbps	RS-485
5	1	125Kbps	RS-485
6	2	125Kbps	RS-485
7	1	125Kbps	RS-485
8	2	125Kbps	RS-485
9	1	125Kbps	RS-485
10	2	125Kbps	RS-485
11	1	125Kbps	RS-485
12	2	125Kbps	RS-485
13	1	125Kbps	RS-485
14	2	125Kbps	RS-485
15	1	125Kbps	RS-485
16	2	125Kbps	RS-485
17	1	125Kbps	RS-485
18	2	125Kbps	RS-485
19	1	125Kbps	RS-485
20	2	125Kbps	RS-485

RS-485

USB

PSH-508

100 Base-TX

100 Base-FX

COM1(RS-232)

COM2(RS-485)

COM3(RS-485)

COM4(RS-485)

COM5(RS-485)

COM6(RS-485)

COM7(RS-485)

COM8(RS-485)

COM9(RS-485)

COM10(RS-485)

COM11(RS-485)

COM12(RS-485)

COM13(RS-485)

COM14(RS-485)

COM15(RS-485)

COM16(RS-485)

COM17(RS-485)

COM18(RS-485)

COM19(RS-485)

COM20(RS-485)

PFC-208

100 Base-FX

COM1(RS-232)

COM2(RS-485)

COM3(RS-485)

COM4(RS-485)

COM5(RS-485)

COM6(RS-485)

COM7(RS-485)

COM8(RS-485)

COM9(RS-485)

COM10(RS-485)

COM11(RS-485)

COM12(RS-485)

COM13(RS-485)

COM14(RS-485)

COM15(RS-485)

COM16(RS-485)

COM17(RS-485)

COM18(RS-485)

COM19(RS-485)

COM20(RS-485)

PFC-208S

100 Base-FX

COM1(RS-232)

COM2(RS-485)

COM3(RS-485)

COM4(RS-485)

COM5(RS-485)

COM6(RS-485)

COM7(RS-485)

COM8(RS-485)

COM9(RS-485)

COM10(RS-485)

COM11(RS-485)

COM12(RS-485)

COM13(RS-485)

COM14(RS-485)

COM15(RS-485)

COM16(RS-485)

COM17(RS-485)

COM18(RS-485)

COM19(RS-485)

COM20(RS-485)

Automation T

Machine Automation



Motionnet Solutions



ET-M8194H

Motion Card

Energy Solutions



PMC

PM-3133/PM-3133-MTCP



Current Sensor Voltage Attenuator



PM-3112/PM-3114

PM-4324

IoT Solutions



IoTstar



UA-5200



amazon web services™



Microsoft Azure



IBM Bluemix™



WISE-7500



WISE-7000



DL Series



MiniOS7



Linux



IoTstar



ISaGRAF/Win-GRAF



HMIWorks



RTU Center



NAPOPC



InduSoft



PAC

I/O

Soft

IC
D



Multi-Port Serial Card



PDS/DS/tDS



Switch

EXPANSION



RU-87Pn



ET-87Pn



iDCS-8830



PROFIBUS



CAN



I-8K/I-87K



X-board



XW-board
XV-board



RS-485/RS-422/
RS-232

Total Solutions



WISE-5800

MQ-7200 PIR/RPIR Series

iCAM series

M2M



SMS series (GT-500 series)

RTU series (GT-540/G-4500)

GRP series (GRP-500 series)

G-4500 series

GTM-20x series

RMV series (M2M-700 series)

Building Automation



HMI & ViewPAC (SV-2201-CE7/VP-25W1/VP-4131)

Tiny I/O Series

IR-310-RM

LC series

TouchPAD

IR-210/IR-712A

Software



Microsoft Windows^{XP} Embedded

Microsoft Windows CE

UniDAQ

VxComm Driver/Utility

Visual Studio.NET

WISE

VCEP

eLogger

EzDataLogger

SMS_DB

PC Card



PO-104

ISA

PCI LOCAL BUS

PCI EXPRESS

Communication



Gateway

Converter

RF

GSM/GPRS

ZigBee

Wi-Fi

WIRED



Ethernet

CAN

PROFIBUS PROFINET

USB

EtherCAT

BACnet

EtherNet/IP

HART

WISE

WIRELESS



3G/4G

ZigBee (ZT Series)

IR

Wi-Fi

ICP DAS

ICP DAS was established in 1993 and is strongly focused on innovation and the enhancement of industrial automation technology. ICP DAS continuously endeavors to develop a comprehensive selection of products ranging from remote I/O controllers, distributed I/O modules, I/O data acquisition boards, programmable automation controllers, industrial communication modules, web-related products, motion control systems, SCADA/HMI software to automation solutions for applications critical to energy management, motion automation, smart factories, intelligent buildings, and smart cities. Our ambition is to provide a wide range of high-quality products and versatile applications, together with prompt and efficient service, that can be implemented to assist in the continued success of our clients worldwide.



Taiwan Headquarters & 1st Factory (Hsinchu)

Our Intelligent Solutions and Comprehensive Service, Your Key to Success.

The inevitable trend toward the implementation of the Internet of Things (IoT) and Industry 4.0 currently leads global cooperation and technology development, and the future demands and business opportunities in this area are potentially unlimited. We believe that one of the key success factors in the advancement of the automation industry is intelligence. Now, however, the evolution of the industry has entered into a phase of intelligent automation, ranging from a single domain with a limited scale to encompassing multiple domains on a significantly expanded scale. Consequently, ICP DAS has transformed itself from simply a hardware provider to a provider of total automation solutions and service integration. As a result, our role in this industry has also been constantly evolving.

When looking back on our past development, we have come to realize that ICP DAS has already been intrinsically involved in the world of IoT and Industry 4.0. The integrated solutions provided by ICP DAS are a combination of both tangible products and intangible services which cover a variety of integrated application services and industry-oriented fields, including:

- ▶ M2M /IOT
- ▶ Machine Automation
- ▶ Panel Solutions
- ▶ Energy Management
- ▶ Building Automation
- ▶ SCADA, InduSoft Solutions

In addition to our close cooperation with worldwide distributors, ICP DAS has forged strong partnerships with those clients who have domain knowledge. We integrate the expertise of our clients with our ability for customization to offer products and services in line with needs. ICP DAS helps our customers to achieve success and that is both our goal and our passion.

At ICP DAS, we are committed to leveraging our considerable experience, our highly professional R&D capabilities, and our innovative products, as well as our dedication to service, in order to work together with you to seize the unquestionable future business opportunities that will arise from the increasing adoption of both IoT and Industry 4.0.



Taiwan 2nd Factory (Hsinchu)



China Training Center (Wuhan)

Industrial Communication

1 Multiport Serial Cards P 6

2 Serial Device Server P 7

- 2.1 Intelligent Serial-to-Ethernet Device Servers - - - - - P 9
- 2.2 Palm-size Programmable Serial-to-Ethernet Device Server - - - - - P 11
- 2.3 Palm-size Serial-to-Ethernet Device Server - - - - - P 13
- 2.4 IP67 Programmable Serial-to-Ethernet Device Server - - - - - P 14
- 2.5 Programmable Serial-to-Fiber Device Server - - - - - P 15
- 2.6 Tiny Serial-to-Ethernet Device Server & Modbus Gateway - - - - - P 16
- 2.7 Programmable Serial Device Server with LAN Switch - - - - - P 19
- 2.8 Programmable Modbus to Ethernet Gateway - - - - - P 20
- 2.9 Modbus Data Concentrator, MDC-700 series - - - - - P 21

3 Converter/Repeater/Hub/Splitter P 23

4 Termination Resistor/DC Bias Voltage P 25

5 Ethernet Switch P 26

6 Fieldbus Solution P 32

- 6.1 EtherNet/IP Gateways - - - - - P 32
- 6.2 BACnet Gateways - - - - - P 33
- 6.3 CAN Bus Repeater/Bridge/Switch - - - - - P 34
- 6.4 USB to CAN Converters - - - - - P 35
- 6.5 CAN to Fiber Converter/Bridge - - - - - P 35
- 6.6 Ethernet/Wi-Fi to CAN Converters - - - - - P 36
- 6.7 Uart to CAN Converters - - - - - P 38
- 6.8 CANopen Gateways - - - - - P 39
- 6.9 DeviceNet Gateways - - - - - P 40
- 6.10 J1939 Gateways - - - - - P 41
- 6.11 CAN Bus Data Logger - - - - - P 42
- 6.12 PC-based CAN Bus Boards - - - - - P 44
- 6.13 Palm-size Programmable CAN Controllers - - - - - P 47
- 6.14 PAC-based CAN Modules - - - - - P 48
- 6.15 PROFIBUS Converters & Gateways - - - - - P 49
- 6.16 PROFINET Converters & Gateways - - - - - P 51
- 6.17 HART Converters, Gateways & Signal Filter - - - - - P 52
- 6.18 M-Bus Converters & Gateways - - - - - P 55

1. Multiport Serial Cards

Overview:

The VXC/VEX multiport card is the foremost choice for PC-based communication solutions, ensuring smooth communication in both time-critical applications and industrial fields. Installing a VXC/VEX multiport card increases the number of serial ports available on the PC, meaning that it is much easier to integrate a PC with a large number of external devices, such as PLCs, meters, controllers, laboratory instruments, modems, card readers, serial printers, RFID readers, bar code readers, and sensors, etc.



Selection Guide:









✓ PCI Express

Model Name	COM-Selector	RS-232	RS-422/485	Self-Tuner	Isolation (Vdc)	ESD Protection	Max. Speed (bps)	FIFO Size (bytes)	Connector
VEX-112	Yes	2	–	–	–	–	115.2 k	128	Male DB-9
VEX-112i	Yes	2	–	–	2.5 k	±4 kV	115.2 k	128	Male DB-9
VEX-142	Yes	–	2	Yes	–	–	115.2 k	128	Male DB-9
VEX-142i	Yes	–	2	Yes	2.5 k	±4 kV	115.2 k	128	Male DB-9
VEX-114	Yes	4	–	–	–	–	115.2 k	128	Female DB-37
VEX-114i	Yes	4	–	–	2.5 k	±4 kV	115.2 k	128	Female DB-37
VEX-144	Yes	–	4	Yes	–	–	115.2 k	128	Female DB-37
VEX-144i	Yes	–	4	Yes	2.5 k	±4 kV	115.2 k	128	Female DB-37
PCIe-S118	–	8	–	–	–	–	921.6 K	256	Female DB-62
PCIe-S148	–	–	8	Yes	–	–	921.6 K	256	Female DB-62

✓ Universal PCI

Model Name	COM-Selector	RS-232	RS-422/485	Self-Tuner	Isolation (Vdc)	ESD Protection	Max. Speed (bps)	FIFO Size (bytes)	Connector
VXC-112AU	Yes	2	–	–	–	–	115.2 k	128	Male DB-9
VXC-112iAU	Yes	2	–	–	2.5 k	±4 kV	115.2 k	128	Male DB-9
VXC-142AU	Yes	–	2	Yes	–	–	115.2 k	128	Male DB-9
VXC-142iAU	Yes	–	2	Yes	2.5 k	±4 kV	115.2 k	128	Male DB-9
VXC-182iAU	Yes	1	1	Yes	2.5 k	±4 kV	115.2 k	128	Male DB-9
VXC-114U	Yes	4	–	–	–	–	115.2 k	128	Female DB-37
VXC-114iAU	Yes	4	–	–	2.5 k	±4 kV	115.2 k	128	Female DB-37
VXC-144U	Yes	–	4	Yes	–	–	115.2 k	128	Female DB-37
VXC-144iU	Yes	–	4	Yes	2.5 k	±4 kV	115.2 k	128	Female DB-37
VXC-118U	–	8	–	–	–	–	115.2 k	256	Female DB-62
VXC-148U	–	–	8	Yes	–	–	115.2 k	256	Female DB-62

Optional Accessories:

CA-0910F		9-Pin Female-Female D-Sub Cable 1 m	CA-9-3715D		Male DB-37 to 4-port Male DB-9 Cable, 1.5 M (180°)
CA-0915		9-Pin Male-Female D-Sub Cable, 1.5 m	CA-9-3705		Male DB-37 to 4-port Male DB-9 Cable, 0.3 M (90°)
CA-PC09F		9-Pin Female D-Sub Connector with Plastic Cover	CA-9-6210		Male DB-62 to 8-port Male DB-9 Cable, 1.0 M
CA-4002		37-Pin Male D-Sub Connector with Plastic Cover	DN-09-2F		I/O Connector Block with DIN-Rail Mounting and Two 9-Pin Male Header. Includes CA-0910F x 2 (9-Pin Female-Female D-Sub Cable 1 m)

2. Serial Device Server

Overview:

The ICP DAS Programmable Device Server is designed to bring network connectivity to your serial devices. The programmable features allow developers to quickly build custom applications that turn "dull" serial devices into "intelligent" devices right away without modifying their hardware or software configuration.

With extensive experience accumulated over many years, a great number of serial devices such as PLCs, bar code readers, RFID readers, meters and motion controllers, etc., have been widely used in various applications. As the advances in communication technologies in recent years, continue to drive optimization of data accessibility and remote operation ability, a wide variety of industries have begun to feel the urge to upgrade their latency serial communications to Ethernet network connections. The ICP DAS PDS series of products are your best choice for implementing this scenario in a robust, reliable and cost-effective way.



The VxComm Driver creates virtual COM port(s) on 32-bit and 64-bit Windows XP/2012/7/10 systems and maps them to the remote serial port(s) of the PDS/DS series. The user's serial client programs need to only be changed to the virtual COM port access the serial devices that are allocated on the Internet or Ethernet network via the PDS/DS series.

Easy Serial Device Networking with "transparency"

The most intuitive and easiest way to remotely control serial devices is to access those devices transparently via a network with no software modification required. The ICP DAS PDS product line offers two transparent applications:

■ Socket Connections:

Using a TCP/IP socket connection, client programs can exchange information with specific PDS/DS serial ports and talk to serial devices directly. For example, simply create a socket connection to the TCP/IP port 10001 (default) of the PDS/DS device and you can then access Port1 of the PDS/DS remotely. This is an OS-independent method and works well on most OS (operating systems) that provide socket functions.

■ Virtual COM Ports:

ICP DAS developed a specific function called "Virtual COM" that simulates PDS serial ports as fixed PC COM ports. Virtual COM ports appear to the system and applications as real ports. Once established, users can immediately enjoy the convenience that networking provides.



DynaCOM Technology

ICP DAS Virtual COM also supports an exclusive function - Dynamic Virtual COM Mapping (DynaCOM); if the system can only access limited or fixed numbers of COM Ports, specific PDS serial ports can be dynamically assigned to the corresponding COM port numbers.

Selection Guide:

Comparison Table of Device Server and Modbus Gateway

Features	iDS	PPDS	PDS	DS	tDS	tGW
Picture						
PoE	Yes	Yes	–	–	Yes	Yes
Programmable	Yes	Yes	Yes	–	–	–
Virtual COM	Yes	Yes	Yes	Yes	Yes	–
Modbus Gateway	–	Yes	–	–	–	Yes
Multi-client	Yes	Yes	Yes	Yes	–	Yes
SNMP	Yes	–	–	–	–	–
Application Mode	Virtual COM TCP Server TCP Client UDP Pair Connection RFC2217 Telnet Modem Emulator	Virtual COM TCP Server TCP Client Pair Connection Modbus TCP Slave	Virtual COM TCP Server TCP Client Pair Connection	Virtual COM TCP Server TCP Client Pair Connection	Virtual COM TCP Server TCP Client Pair Connection	Modbus TCP Master Modbus TCP Slave Modbus UDP Master Modbus UDP Slave Pair Connection
Remarks	Intelligent	Professional	Powerful	Isolation for DS-715	Cost-effective, Entry-level	Cost-effective, Entry-level

✓ iDS Series – Intelligent Device Server

Series	Ethernet	Virtual COM	Virtual I/O	Programmable	Modbus	Case
iDS-700	10/100 M, PoE	Yes	–	Yes	Yes	Plastic
iDS-700M						Metal

✓ PPDS Series – Programmable Device Server and Modbus Gateway with PoE

Series	Ethernet	Virtual COM	Virtual I/O	Programmable	Modbus	Case
PPDS-700-MTCP	10/100 M, PoE	Yes	Yes	Yes	Yes	Plastic
PPDSM-700-MTCP						Metal
PPDS-700-IP67			–		–	IP67 Waterproof Plastic

✓ PDS Series – Programmable Device Server

Series	Ethernet	Virtual COM	Virtual I/O	Programmable	Modbus	Case
PDS-700	10/100 M	Yes	Yes	Yes	–	Plastic
PDSM-700						Metal
PDS-220Fx	100 Base-FX, Fiber		–		–	–
PDS-5000-MTCP	10/100 M Ethernet Switch	–	–	–	Yes	Plastic

✓ DS, tDS & tGW Series – Non-Programmable Device Server and Modbus Gateway

Series	Ethernet	Virtual COM	Virtual I/O	Multi-client	Modbus	Casing	Remarks
tDS-700	10/100 M, PoE	Yes	–	–	–	Plastic	Cost-effective
tGW-700		–		Yes	Yes		

2.1 Intelligent Serial-to-Ethernet Device Servers

iDS-700

iDS-400

Intelligent Serial-to-Ethernet Device Servers



iDS-718-D

iDS-745M-T

iDS-448iM-D



Features:

- Simple setup, factory floor devices can be connected to SCADA systems in minutes
- Serial Devices can be monitored and controlled via the Ethernet
- Supports 1/2/4-port RS-232, RS-422 and RS-485 communications
- Web-based configuration and PC Utility
- Supports RS-485 Data Direction Control with Self-Tuner Technology
- Provides Virtual COM (COM port redirection), TCP Server/Client (Max. 32 connections), UDP, Serial Tunnel (Pair connection), Modem Emulator, and RFC2217 application modes.
- Reset button for restoring the factory configuration
- Supports SNMP V1, V2c, V3, Trap and MIB-II protocols for network management
- Built-in Hardware-selectable Pull High/Low resistors and Terminal resistors for RS-422/485 ports
- Serial ESD protection
- Includes a Smart Ethernet Port that recognizes both straight and crossover Ethernet Cables
- Built-in Buzzer, RTC, and Watchdog
- RoHS Compliant
- Wide operating temperature range: -25 to +75°C

Introduction:

Introducing the All-new Device Server

Cost, Performance and Reliability in Total Alignment



The iDS product range is the 3rd generation of Device Servers from ICP DAS. It is designed for rugged, industrial-level applications, and provides high performance, high reliability and high capacity.

The iDS product range provides a complete Ethernet service, as well as 1-, 2-, and 4-port RS-232/RS-422/RS-485 interfaces that allow any existing serial devices to be connected to an Ethernet network.

Industry 4.0 is Coming



ICP DAS iDS Product	32 TCP connections
Traditional Device Server	8 TCP Connections

More connections mean greater connectivity for integration with the Internet of Things

Taking the Long-term View

A comprehensive serial-to-Ethernet Service

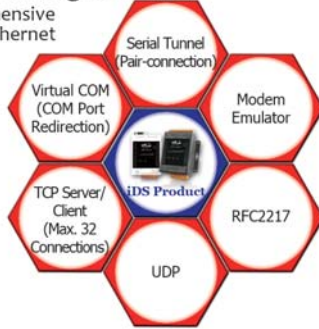

We Know Time is Everything

Quick and Easy Installation



- ◀ 3-IN-1 COM PORT, RS-232/422/485
- ◀ Dual COM Port Selection Method (Hardware and Software)
- ◀ PoE and Daisy Chain Design
- ◀ Web Configuration and PC Utility

Powerful Data Transparent Solution: Zero Data Loss

The iDS product range is equipped with an ARM-based high-performance CPU and large capacity RAM in order to accomplish the goal of "Zero Data Loss" when attempting to transfer a critical data stream. If a failure occurs on the Ethernet connection, the serial data will be queued and will be resent once the Ethernet is reconnected. Each device port provides 32 TCP connections that can be used to share the same information across the network from a single serial device.

Industrial-grade Design

The iDS product range provides a wide range of built-in features designed for easy deployment of the device into existing operating environments.

1. Dual Power Supply: DC and PoE
2. DIN-Rail Mounting
3. Serial Port Surge Protection
4. Adjustable RS-485 Terminal Resistor and Pull High/Low Resistor
5. RS-485 Direction Control via the embedded ICP DAS Self-Tuner
6. Hardware/Software-selectable RS-232, RS-422 or RS-485 Interfaces
7. Hardware Reset button and LED Indicator
8. 64-bit Hardware Serial Number



COM1	M1	M0	DIP Switch
RS-232	ON	OFF	ON <input type="checkbox"/> <input type="checkbox"/> <input type="checkbox"/> <input type="checkbox"/> <input type="checkbox"/> <input type="checkbox"/> <input type="checkbox"/> <input type="checkbox"/>
RS-422	OFF	ON	ON <input type="checkbox"/> <input type="checkbox"/> <input type="checkbox"/> <input type="checkbox"/> <input type="checkbox"/> <input type="checkbox"/> <input type="checkbox"/> <input type="checkbox"/>
RS-485	OFF	OFF	ON <input type="checkbox"/> <input type="checkbox"/> <input type="checkbox"/> <input type="checkbox"/> <input type="checkbox"/> <input type="checkbox"/> <input type="checkbox"/> <input type="checkbox"/>
Software	ON	ON	ON <input type="checkbox"/> <input type="checkbox"/> <input type="checkbox"/> <input type="checkbox"/> <input type="checkbox"/> <input type="checkbox"/> <input type="checkbox"/> <input type="checkbox"/>

Easy web-based Configuration

The built-in web server allows the iDS product to be accessed and configured using a standard web browser, such as Internet Explorer or Google Chrome. The configurations include parameters of serial ports, SNMP, the mode of Serial-To-Ethernet service. In addition, the onboard Flash memory provides the capacity for future software upgrades.



IT-friendly Management

All devices in the iDS product range support the SNMP protocol, which is a popular method within the IT industry for monitoring a device over the Ethernet. The iDS device can be configured to send SNMP-Trap alerts to the SNMP manager if user-defined errors or events are encountered. For example, alerts can be triggered by a warm/cold start events, or a password change, etc. An email alert and web-based event log page is also provided.

Perfect Harmony

Making the right decision leads to lazy days on the beach



- ▶ Remote Configuration and Upgrades
- ▶ Embedded Watchdog prevents System Freeze
- ▶ Event and Alarm Logs with Timestamp
- ▶ Event alert: SNMP Trap, E-mail

Ordering Information:

Model No.	Description
iDS-718i-D CR	Intelligent Device Server with 1 RS-232/422/485 (Isolated, RoHS, DB9)
iDS-718iM-D CR	Intelligent Device Server with 1 RS-232/422/485 (Isolated, Metal Case, RoHS, DB9)
iDS-728i-T CR	Intelligent Device Server with 2 RS-232/422/485 (RoHS, Terminal block)
iDS-728iM-T CR	Intelligent Device Server with 2 RS-232/422/485 (Metal Case, RoHS, Terminal block)
iDS-448iM-D CR	Intelligent Device Server with 4 RS-232/422/485 (Metal Case, RoHS, DB9)

2.2 Palm-size Programmable Serial-to-Ethernet Device Server

PDS-720(D)

PPDS-720(D)-MTCP

Programmable Device Server with 1 RS-232, 1 RS-422/485 and 1 Fiber ports



PPDS-720D-MTCP PDS-720



PDS-782-25/D6

PDS-782D-25/D6

Programmable Device Server with 7 RS-232 ports and 1 RS-485 port



PDS(M)-700(D) Series

PPDS(M)-700(D)-MTCP Series

Programmable Device Server with 1 RS-232 port and 1 RS-485 port



PPDS-700D-MTCP series PDSM-700D series



Features:

- Incorporates serial devices in an Ethernet network
- Operation Modes: Virtual COM, TCP Server, TCP Client
- Virtual COM for 32/64-bit Windows XP/2012/7/10
- Supports Modbus TCP to RTU/ASCII Gateway (for MTCP versions)
- Powerful programmable device server with lib and sample programs
- Built-in high performance MiniOS7 from ICP DAS
- Built-in watchdog timer suitable for use in harsh environments
- Built-in Self-Tuner on RS-485 Ports (automatic direction control)
- Supports ±4 kV ESD protection on serial ports
- Power reverse polarity protection and low power consumption
- 10/100 Base-TX Ethernet, RJ-45 Port (Auto-negotiating, auto MDI/MDI-X, LED indicator)
- Supports PoE (Power over Ethernet, for PPDS versions)
- Built-in 7-Segment 5-digit LED display (for D versions)
- Supports D/I, latched D/I and counter functions (for models with DIO)
- Supports Virtual I/O technology (for models with DIO)
- Supports IP filter (White List) for security control
- Supports multi-client and data sharing function
- Palm-size form factor with multiple serial ports and DIN-Rail mounting
- RoHS Compliant & no Halogen
- OEM/ODM service is available

Selection Guide:

Model Name	RS-232	RS-485	RS-422/ RS-485	DI/DO	Ethernet	COM1	COM2	COM3	COM4	COM5	COM6	COM7	COM8
PDS-720(D) PPDS-720(D)-MTCP	1	1	-	-	10/100 M	5 Wire RS-232	2 Wire RS-485	-	-	-	-	-	-
PDS(M)-721(D) PPDS(M)-721(D)-MTCP	1	1	-	6/7	10/100 M	5 Wire RS-232	2 Wire RS-485	-	-	-	-	-	-
PDS(M)-732(D) PPDS(M)-732(D)-MTCP	2	1	-	4/4	10/100 M	5 Wire RS-232	2 Wire RS-485	5 Wire RS-232	-	-	-	-	-
PDS(M)-734(D) PPDS(M)-734(D)-MTCP	1	1	1	4/4	10/100 M	5 Wire RS-232	2 Wire RS-485	RS-422/ RS-485	-	-	-	-	-
PDS(M)-742(D) PPDS(M)-742(D)-MTCP	3	1	-	-	10/100 M	5 Wire RS-232	2 Wire RS-485	5 Wire RS-232	9 Wire RS-232	-	-	-	-
PDS(M)-743(D) PPDS(M)-743(D)-MTCP	3	1	-	4/4	10/100 M	5 Wire RS-232	2 Wire RS-485	3 Wire RS-232	3 Wire RS-232	-	-	-	-
PDS(M)-752(D) PPDS(M)-752(D)-MTCP	4	1	-	-	10/100 M	5 Wire RS-232	2 Wire RS-485	5 Wire RS-232	5 Wire RS-232	5 Wire RS-232	-	-	-
PDS(M)-755(D) PPDS(M)-755(D)-MTCP	1	4	-	-	10/100 M	5 Wire RS-232	2 Wire RS-485	2 Wire RS-485	2 Wire RS-485	2 Wire RS-485	-	-	-
PDS(M)-762(D) PPDS(M)-762(D)-MTCP	5	1	-	1/2	10/100 M	5 Wire RS-232	2 Wire RS-485	3 Wire RS-232	3 Wire RS-232	3 Wire RS-232	3 Wire RS-232	-	-
PDS(M)-782(D) PPDS(M)-782(D)-MTCP	7	1	-	-	10/100 M	5 Wire RS-232	2 Wire RS-485	3 Wire RS-232	3 Wire RS-232	3 Wire RS-232	3 Wire RS-232	3 Wire RS-232	3 Wire RS-232
PDS-782(D)-25/D6	7	1	-	-	10/100 M	5 Wire RS-232	2 Wire RS-485	3 Wire RS-232	3 Wire RS-232	3 Wire RS-232	3 Wire RS-232	3 Wire RS-232	3 Wire RS-232

Note:

1. The D version modules have a built-in 7-Seg. LED Display.
2. The M version modules use metal case.
3. The PPDS-700-MTCP series modules support PoE (Power over Ethernet) and Modbus Gateway.

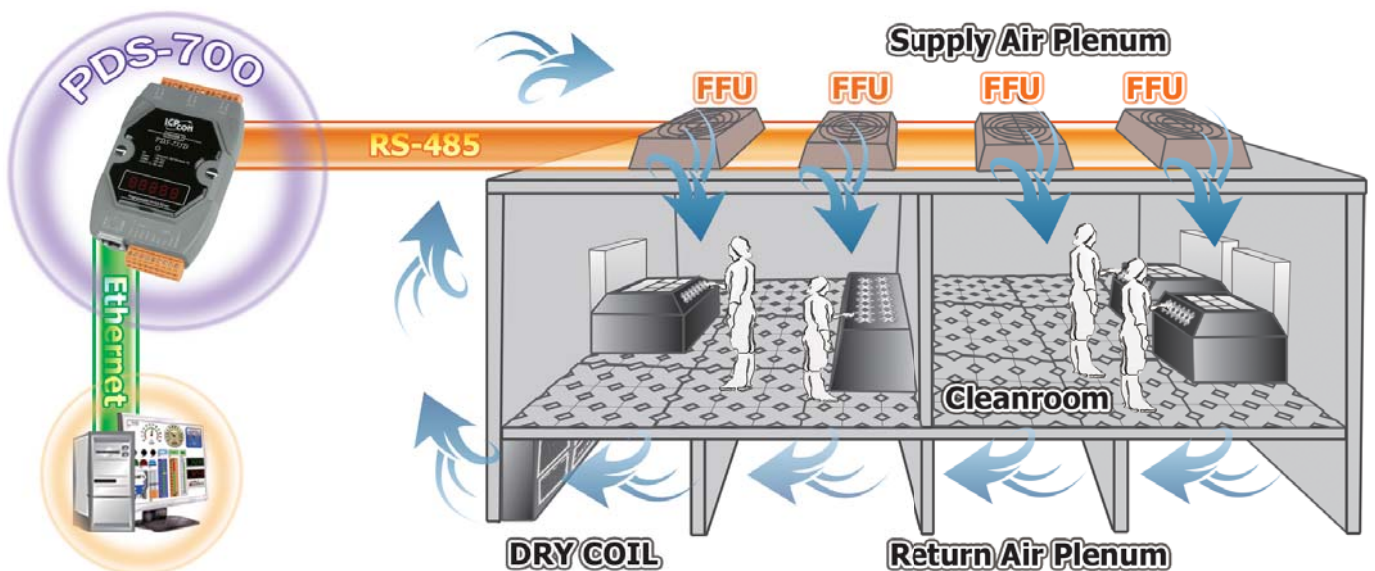

2.3 Palm-size Serial-to-Ethernet Device Server

DS-712

Serial-to-Ethernet Device Server with 1 RS-232 port

DS-715

Serial-to-Ethernet Device Server with 1 RS-422/RS-485 port



Features:

- Incorporate Serial Devices in an Ethernet network
- Operation Modes: Virtual COM, TCP Server, TCP Client
- Virtual COM for 32/64-bit Windows XP/2012/7/10
- Watchdog Timer suitable for use in harsh environments
- 10/100 Base-TX, RJ-45 Port
(Auto-negotiating, auto MDI/MDI-X, LED indicator)
- Built-in High Performance MiniOS7 from ICP DAS
- High Performance Device Server
- Power Reverse Polarity Protection
- RoHS Compliant & no Halogen
- Serial Port ± 4 kV ESD Protection Circuit
- Low power consumption
- Palm-Size with DIN-Rail Mounting
- Male DB-9 Connector

Introduction:

The DS-700 is a series of Serial-to-Ethernet Device Servers that are designed for linking RS-232/422/485 devices to an Ethernet network. By using the VxComm Driver/Utility, the built-in COM port of the DS-700 series can be virtualized to a standard PC COM port in Windows. By virtue of its protocol independence, a small size and flexibility, the DS-700 series meets the demands of virtually any network-enabled application.

The DS-712 is equipped with a male DB-9 connector and supports a 5 Wire RS-232 port, while the DS-715 is equipped with a removable terminal block connector and supports a 4 Wire RS-422 port or a 2 Wire RS-485 port with 2000 Vrms isolation.

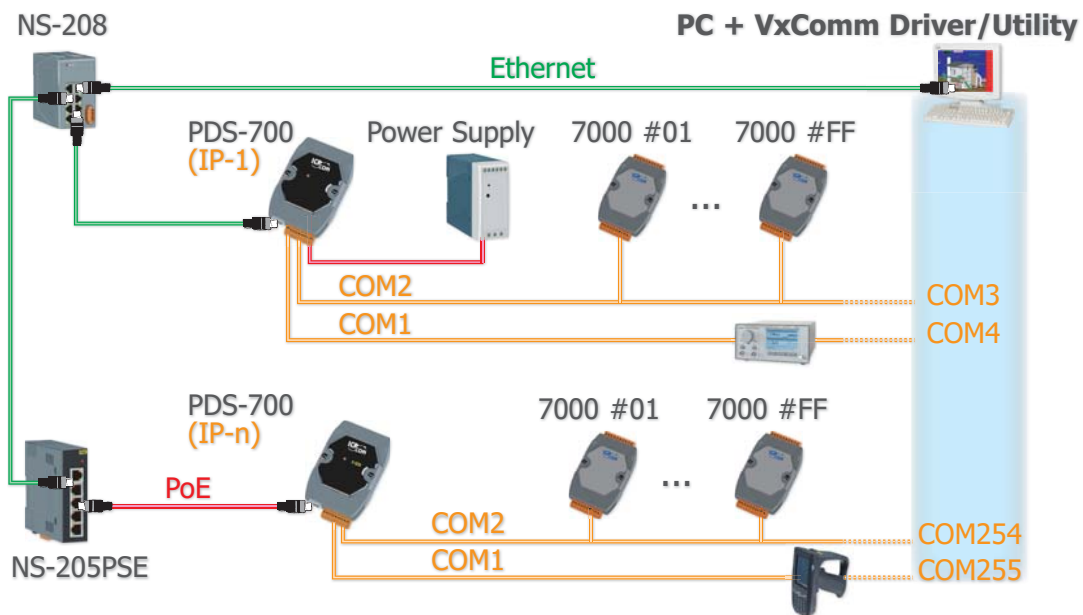

Ordering Information:

Model No.	Description
DS-712 CR	Device Server with 1 RS-232 port (RoHS)
DS-715 CR	Device Server with 1 Isolated RS-422/RS-485 port (RoHS)

2.4 IP67 Programmable Serial-to-Ethernet Device Server

PPDS-741-IP67 *Available soon*

PPDS-742-IP67

PPDS-743-IP67 *Available soon*

Programmable Device Server with 4 RS-232 or RS-485 ports,
PoE and IP67 Casing



Features:

- Incorporate Serial Devices in an Ethernet network
- Virtual COM for 32-bit and 64-bit Windows XP/2012/7/10
- Watchdog Timer suitable for use in harsh environments
- 10/100 Base-TX, RJ-45 Port
(Auto-negotiating, auto MDI/MDI-X, LED indicator)
- Built-in High Performance MiniOS7 from ICP DAS
- Self-Tuner ASIC Controller on the RS-485 Port
- Powerful Programmable Device Server
- Rugged RJ-45 Connector for anti-vibration and shock
- Plastic Casing with IP67 Waterproof
- Power Reverse Polarity Protection
- RoHS Compliant & no Halogen
- Serial Port ± 4 kV ESD Protection Circuit
- Low power consumption
- Supports PoE (IEEE 802.3af, Class 1)
- ODM Service is available

Introduction:

The PPDS-700-IP67 series is a family of Programmable Device Servers, also known as "Serial-to-Ethernet gateway", that are designed for linking RS-232/422/485 devices to an Ethernet network. The user-friendly VxComm Driver/Utility allows users to easily turn the built-in COM ports of the PPDS-700-IP67 series into standard COM ports on a PC. By virtue of its protocol independence, a small-core OS and high flexibility, the PPDS-700-IP67 series is able to meet the demands of every network-enabled application.

The PPDS-700-IP67 series includes a powerful and reliable Xserver programming structure that allows you to design your robust Ethernet applications in one day. The built-in, high-performance MiniOS7 boots the PPDS-700-IP67 up in just one second and gives you fastest responses.

The PPDS-700-IP67 is a special design for the toughest applications. It can be directly mounted to any machine or convenient flat surface. The rugged packaging and IP67 connectors are rated to protect against water, oil, dust, vibration, and much more.

The PPDS-700-IP67 supports PoE (Power over Ethernet) function that allows power and data to be carried over a single Ethernet cable, so a device can operate solely from the power it receives through the data cable. This innovation allows greater flexibility in office design, higher efficiency in systems design, and faster turnaround time in set-up and implementation. When there is no PoE switch on site, the PPDS-700-IP67 accepts power input from a +12 VDC ~ +48 VDC adapter.

When using PoE devices such as the PPDS-700-MTCP, PPDS-700-IP67 and PET-7000 (Ethernet I/O module with PoE), you can select the ICP DAS "PoE" switch – "NS-205PSE" – as the power source. The NS-205PSE automatically detects whether the connected devices are PoE devices or not. This mechanism ensures that the NS-205PSE will work with both PoE and non-PoE devices simultaneously.

As a power source for PoE devices, the NS-205PSE requires a power input ranging from +46 VDC ~ +55 VDC.

Ordering Information:

Model No.	Description
PPDS-741-IP67 CR	Programmable Device Server with 1 RS-232 port, 3 RS-485 ports, PoE and IP67 Casing (RoHS)
PPDS-742-IP67 CR	Programmable Device Server with 2 RS-232 ports, 2 RS-485 ports, PoE and IP67 Casing (RoHS)
PPDS-743-IP67 CR	Programmable Device Server with 3 RS-232 ports, 1 RS-485 port, PoE and IP67 Casing (RoHS)

2.5 Programmable Serial-to-Fiber Device Server

PDS-220Fx

Programmable Device Server with 1 RS-232, 1 RS-422/485 and 1 Fiber ports



Features:

- Adds optical fiber connectivity to serial devices
- Virtual COM for 32-bit and 64-bit Windows XP/2012/7/10
- Watchdog Timer suitable for use in harsh environments
- Serial Port ±4 kV ESD Protection Circuit
- RoHS Compliant & no Halogen
- 100 Base-FX (SC/ST connector)
- Low power consumption
- "Virtual COM" extends PC COM ports
- Powerful Programmable Device Server
- Power Reverse Polarity Protection
- Self-tuner ASIC Controller on the RS-485 port
- Built-in high performance MiniOS7 from ICP DAS
- ODM Service is available

Introduction:

The PDS-220Fx series is a family of Programmable Device Servers, also known as "Serial-to-Fiber gateway", that are designed for adding optical fiber connectivity to RS-232/422/485 devices.

The fiber-optic communications permits transmission over longer distances than other forms of communications because of the signals travel along them with less loss and no crosstalk. It has following important features:

- Immunity to electromagnetic interference (EMI) — Motors, relays, welders and other industrial equipment generate a tremendous amount of electrical noise that can cause major problems with copper cabling.
- High electrical resistance, making it safe to use near high voltage equipment or between areas with different earth potentials.
- No sparks — important in flammable or explosive gas environments.
- Not electromagnetically radiating, and difficult to tap without disrupting the signal — important in high-security environments.

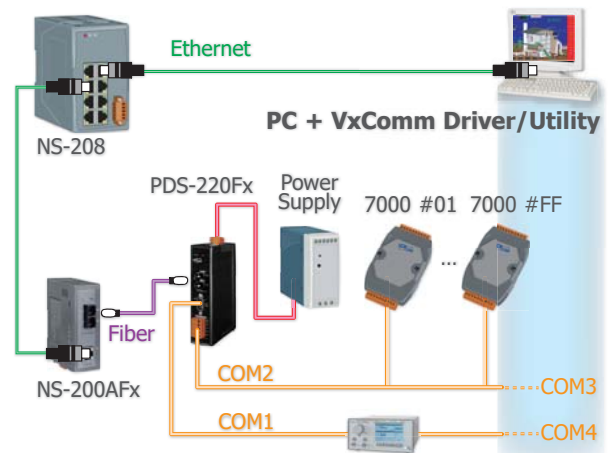

Because of these reasons, optical fibers have largely replaced copper wire communications in core networks in the developed world. The user-friendly VxComm Driver/Utility allows users to easily turn the built-in COM ports of the PDS-220Fx series into standard COM ports on a PC. By virtue of its protocol independence, a small-core OS and high flexibility, the PDS-220Fx series is able to meet the demands of every network-enabled application.

The PDS-220Fx series includes a powerful and reliable Xserver programming structure that allows you to design your robust Ethernet applications in one day. The built-in, high-performance MiniOS7 boots the PDS-220Fx up in just one second and gives you fastest responses.

The PDS-220Fx is equipped with 1 RS-232 port and 1 RS-422/485 port. The removable onboard terminal block connector is designed for easy and robust wiring in industrial situations.

Ordering Information:

Model No.	Description
PDS-220FT CR	Programmable Device Server with 1 RS-232, 1 RS-422/485 and 1 Multi-mode ST Fiber Port (RoHS)
PDS-220FC CR	Programmable Device Server with 1 RS-232, 1 RS-422/485 and 1 Multi-mode SC Fiber Port (RoHS)
PDS-220FCS CR	Programmable Device Server with 1 RS-232, 1 RS-422/485 and 1 Single-mode SC Fiber Port (RoHS)
PDS-220FCS-60 CR	Programmable Device Server with 1 RS-232, 1 RS-422/485 and 1 Single-mode SC Fiber Port (RoHS)

2.6 Tiny Serial-to-Ethernet Device Server & Modbus Gateway

tDS-700/tDS-2200 Series

Tiny Serial-to-Ethernet Device Server



Features:

- Incorporates any RS-232/422/485 serial device in Ethernet
- Contains a 32-bit MCU that efficiently handles network traffic
- Operation Modes: Virtual COM, TCP Server, TCP Client
- Virtual COM for 32/64-bit Windows XP/2012/7/10
- Data Packing Modes: Length, Delimiter, timeout, Char-timeout
- Supports pair-connection (serial-bridge, serial-tunnel) applications
- Supports UDP responder for device discovery (UDP Search)
- Tiny Web server for serial and network configuration (HTTP)
- Easy firmware update via the Ethernet (BOOTP, TFTP)
- Static IP or DHCP network configuration
- Allows automatic RS-485 direction control

- tDS-700/tDSM-712: 10/100 Base-TX Ethernet, RJ-45 × 1
- tDS-2200: 2-port Ethernet Switch (LAN Bypass for Daisy-Chain Wiring)
- Includes redundant power inputs: PoE and DC jack
- Male DB-9 or terminal block connector for easy wiring
- Tiny form-factor and low power consumption



Introduction:

The tDS-700 is a series of Serial-to-Ethernet device servers designed to add Ethernet and Internet connectivity to any RS-232 and RS-422/485 device, and to eliminate the cable length limitation of legacy serial communication. By using the VxComm Driver/Utility, the built-in COM port of the tDS-700 series can be virtualized to a standard PC COM port in Windows. Therefore, users can transparently access or monitor serial devices over the Internet/Ethernet without software modification.

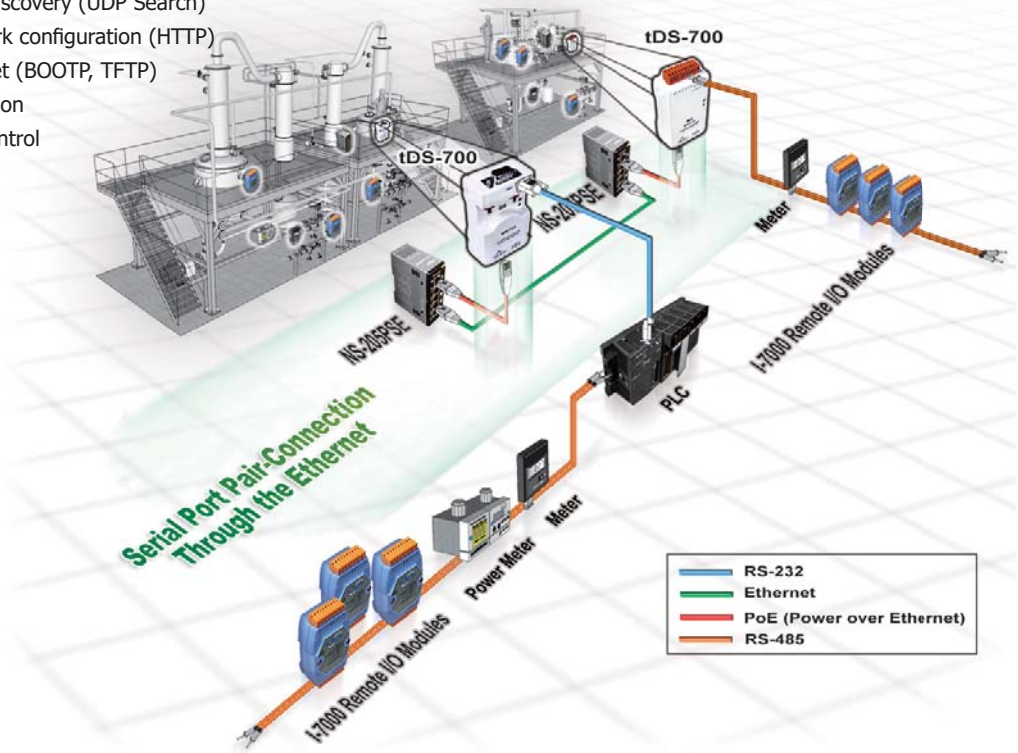

Ordering Information:

tDS-700/tDS-2200 Series (Tiny Device Server with PoE and DC jack) : Includes one CA-002 cable.							
Model (Non-Isolated)	Model (Isolated)	Case	COM Port	Ethernet	Isolation	ESD Protection	Power Input
tDS-712 CR	▶tDS-712i CR	Plastic	1 × RS-232	1-Port, 10/100 M	3000 VDC for "i" version	±4 kV	+12 ~ 48 VDC (Includes 1 × CA-002 cable) or PoE (IEEE 802.3af, Class 1)
tDSM-712 CR	-	Metal					
tDS-722 CR	▶tDS-722i CR	Plastic	2 × RS-232				
tDS-732 CR	▶tDS-732i CR	Plastic	3 × RS-232				
tDS-715 CR	tDS-715i CR	Plastic	1 × RS-422/RS-485				
tDS-725 CR	tDS-725i CR	Plastic	2 × RS-485				
tDS-735 CR	tDS-735i CR	Plastic	3 × RS-485				
tDS-718 CR	▶tDS-718i CR	Plastic	1 × RS-232 or RS-422/485				
tDS-724 CR	▶tDS-724i CR	Plastic	1 × RS-485 1 × RS-232				
tDS-734 CR	▶tDS-734i CR	Plastic	1 × RS-485 2 × RS-232				
▶tDS-2212 CR	-	Plastic	1 × RS-422/RS-485	2-Port Switch, 10/100 M	-	±4 kV	+12 ~ 48 VDC or PoE (IEEE 802.3af, Class 1)
▶tDS-2215 CR	-	Plastic	1 × RS-485				
▶tDS-2225 CR	-	Plastic	2 × RS-485				
▶tDS-2235 CR	-	Plastic	3 × RS-485				
▶tDS-2218 CR	-	Plastic	1 × RS-232 or RS-422/ 485				

Note: ▶ Available soon

tGW-700/tGW-2200 Series

Tiny Modbus/TCP to RTU/ASCII Gateway

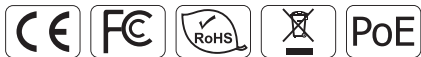

Features:

- Supports Modbus TCP/UDP master and slave
- Supports Modbus RTU/ASCII master and slave
- Read-cache ensures faster Modbus TCP/UDP response
- Supports UDP responder for device discovery (UDP Search)
- Tiny Web server for serial and network configuration (HTTP)
- Easy firmware update via the Ethernet (BOOTP, TFTP)

tGW-712

tGW-700 series

tGW-2200 series



- tGW-700: 10/100 Base-TX Ethernet, RJ-45 × 1
- tGW-2200: 2-port Ethernet Switch (LAN Bypass for Daisy-Chain Wiring)
- Includes redundant power inputs: PoE and DC jack
- Allows automatic RS-485 direction control
- Male DB-9 or terminal block connector for easy wiring

Introduction:

The tGW-700/tGW-2200 series module is a Modbus gateway that enables a Modbus TCP/UDP host to communicate with serial Modbus RTU/ASCII devices through an Ethernet network, and eliminates the cable length limitation of legacy serial communication devices. The module can be used to create a pair-connection application, and can then route data over TCP/IP between two serial Modbus RTU/ASCII devices, which is useful when connecting mainframe computers, servers or other serial devices that use Modbus RTU/ASCII protocols and do not themselves have Ethernet capability.

The tGW-700 series provide 1-port Ethernet and tiny form-factor, while the tGW-2200 series provide 2-port Ethernet Switch and permits the daisy chain connection. These modules achieve maximum space savings that allows it to be flexibility and easily installed anywhere.

Modbus TCP/UDP Master to Modbus RTU/ASCII Slave

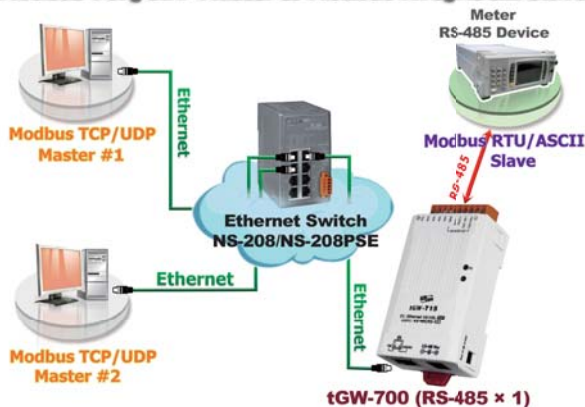

Daisy-Chain Ethernet Cabling



tGW-2200 series

Ordering Information:

Model (Non-Isolated)	Model (Isolated)	COM Port	Max. TCP Connections (Masters)	Ethernet	Isolation	ESD Protection	Power Input
tGW-712 CR	▶tGW-712i CR	1 × RS-232	32	1-Port, 10/100 M	3000 VDC for "i" version	±4 kV	+12 ~ 48 VDC (Includes 1 × CA-002 cable) or PoE (IEEE 802.3af, Class 1)
tGW-722 CR	▶tGW-722i CR	2 × RS-232	16				
tGW-732 CR	▶tGW-732i CR	3 × RS-232	10				
tGW-715 CR	tGW-715i CR	1 × RS-422/RS-485	32				
tGW-725 CR	tGW-725i CR	2 × RS-485	16				
tGW-735 CR	tGW-735i CR	3 × RS-485	10				
tGW-718 CR	▶tGW-718i CR	1 × RS-232 or RS-422/485	32				
tGW-724 CR	▶tGW-724i CR	1 × RS-485 1 × RS-232	16				
tGW-734 CR	▶tGW-734i CR	1 × RS-485 2 × RS-232	10				
▶tGW-2212 CR	-	1 × RS-422/RS-485	32	2-Port Switch, 10/100 M	-	±4 kV	+12 ~ 48 VDC or PoE (IEEE 802.3af, Class 1)
▶tGW-2215 CR	-	1 × RS-485	32				
▶tGW-2225 CR	-	2 × RS-485	16				
▶tGW-2235 CR	-	3 × RS-485	10				
▶tGW-2218 CR	-	1 × RS-232 or RS-422/485	32				

Note: ▶ Available soon

tSH-700 Series NEW

Tiny Serial Port Sharer



tSH-700 series



Features:

- Supports baud rate conversion application
- Supports two masters sharing one slave port
- Read-cache ensures faster response
- Redundant power inputs: PoE and DC jack
- Tiny form-factor and low power consumption
- Supports Modbus RTU/ASCII protocol conversion
- Raw data mode for most query-response protocols
- Built-in web server for easy configuration (HTTP)
- Allows automatic RS-485 direction control

Introduction:

The tSH-700 module provides a number of functions, including "Baud Rate Conversion", "Modbus RTU/ASCII Conversion" and "Two Masters Share One Slave". The built-in web server provides easy configuration interface, and no console commands are required.

● Baud Rate Conversion:

This function allows a single master device to communicate with slave devices using different baud rates and data formats. Most query-response protocols (half-duplex), e.g. DCON, are supported in the raw data mode. Full-duplex communication should also work when the data size is smaller than the built-in 512 bytes buffer on each serial port.

● Modbus RTU/ASCII Conversion:

This function allows a single Modbus RTU/ASCII master device to communicate with Modbus RTU/ASCII slave devices using different protocols, baud rates and data formats.

● Two Masters Share One Slave:

This function allows two master devices connected to different serial ports to share slave devices. The queries from the masters are queued in the tSH-700 module and then processed one-by-one. Modbus mode can be used to convert the Modbus RTU/ASCII protocols, while raw data mode can be used for DCON or other query-response protocols. Different baud rates and data formats can also be used on the different serial ports.

● Read-Cache Function:

The built-in read-cache function is used to store previous requests and responses of the Modbus messages in the memory buffer of the tSH-700 module. When other HMI/SCADA master controllers requiring the same information from the same slave RTU device, the cached response is returned immediately. This feature dramatically reduces the loading on the slave serial port communication, ensures faster responses to the master, and improves the stability of the entire system.

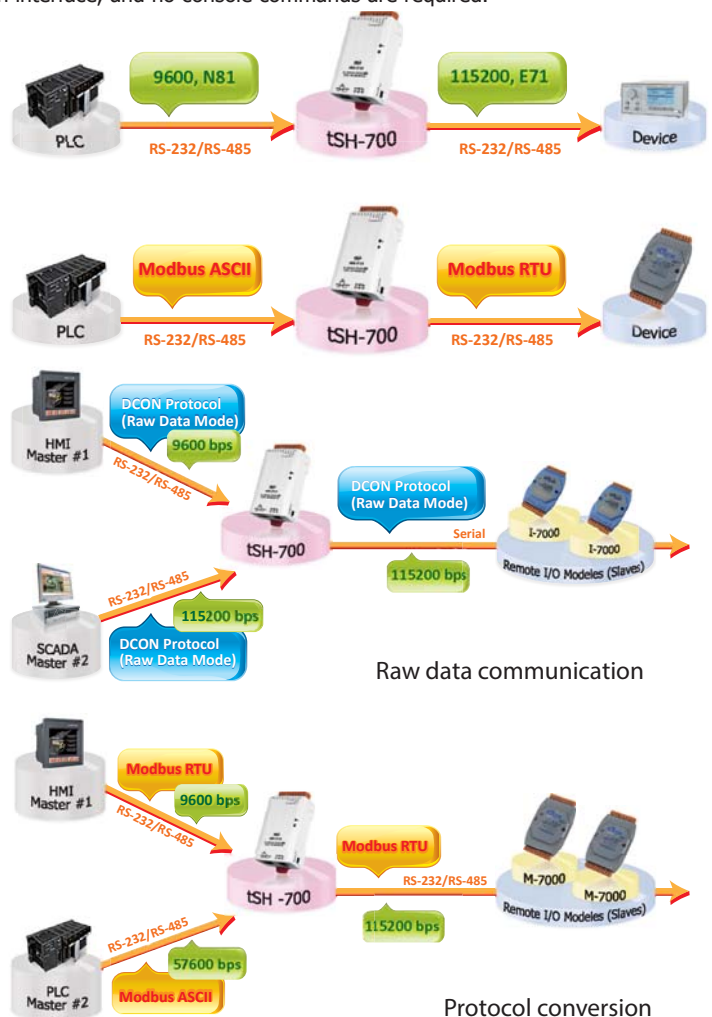

Raw data communication

Protocol conversion

Ordering Information:

tSH-700 Series (Tiny Serial Port Converter/Sharer with PoE and DC jack) : Includes one CA-002 cable.

Model (Non-Isolated)	Model (Isolated)	RS-232	RS-485	Application	COM1	COM2	COM3
tSH -722 CR	▶ tSH -722i CR	2	-	Converter	3-wire RS-232	3-wire RS-232	-
tSH -725 CR	▶ tSH -725i CR	-	2		2-wire RS-485	2-wire RS-485	-
tSH -724 CR	▶ tSH -724i CR	1	1	Sharer	2-wire RS-485	3-wire RS-232	-
tSH -732 CR	▶ tSH -732i CR	3	-		3-wire RS-232	3-wire RS-232	3-wire RS-232
tSH -735 CR	▶ tSH -735i CR	-	3		2-wire RS-485	2-wire RS-485	2-wire RS-485
tSH -734 CR	▶ tSH -734i CR	2	1		2-wire RS-485	3-wire RS-232	3-wire RS-232

Note: ▶ Available soon

2.7 Programmable Serial Device Server with LAN Switch

PDS-5105D-MTCP

Programmable Device Server with 10 RS-485 Ports, 2-port LAN Switch and LED Display



Features:

- Integrates any RS-485 serial device in an Ethernet Network
- Virtual COM extends the PC COM ports
- Virtual COM supports 32-bit and 64-bit Windows XP/2012/7/10
- Provides 10 RS-485 ports with Self-Tuner (Auto-direction control)
- ±2 kV ESD protection on serial ports
- RoHS compliant & no halogen
- 2-port 10/100 Base-TX Ethernet Switch with LAN Bypass
- Powerful programmable device server
- Watchdog timer suitable for use in harsh environments
- Power reverse polarity protection
- Built-in high performance MiniOS7 from ICP DAS
- ODM service is available
- Low power consumption

Introduction:

The PDS-5105D-MTCP is a Programmable Device Server, also known as a "Serial-to-Ethernet gateway" that is designed to allow Ethernet connectivity to be added to RS-232/485 devices.

The user-friendly VxComm Driver/Utility allows users to easily turn the built-in COM ports of the PDS-5105D-MTCP series into standard COM ports on a PC. By virtue of its protocol independence, specialized OS and high flexibility, the PDS-5105D-MTCP series is able to meet the demands of any network-enabled application.

The PDS-5105D-MTCP series includes a powerful and reliable Xserver programming structure that allows you to quickly develop custom robust Ethernet applications. The built-in, high-performance MiniOS7 boots the PDS-5105D-MTCP up in just one second and gives you the fastest response.

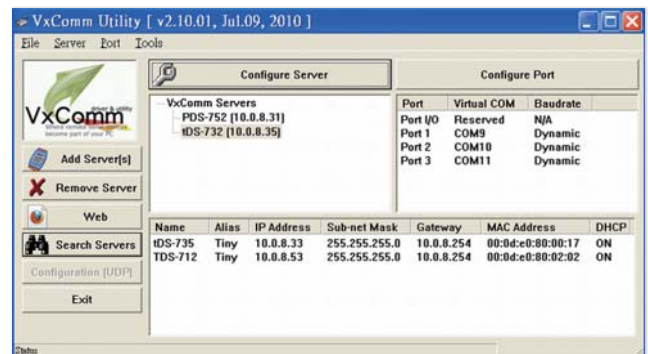

2-port Ethernet Switch with LAN Bypass

The PDS-5105D-MTCP is equipped with a 2-port 10/100Base-Tx Ethernet switch that simplifies network wiring by cascading Ethernet devices. Furthermore, the module features a LAN Bypass function allowing network traffic to be continued between two network segments (Ethernet port1 and port2). In cases where the module is offline due to software, hardware or power failure, the LAN Bypass function will be automatically activated, and the essential communications on the network can continue operating without interruption.

LAN Bypass Feature

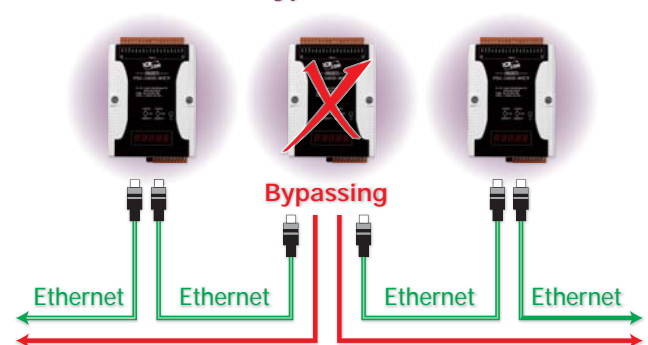

Ordering Information:

Model No.	Description
PDS-5105D-MTCP CR	Programmable Device Server with 10 RS-485 Ports, 2-port LAN Switch and LED Display. (RoHS)

2.8 Programmable Modbus to Ethernet Gateway

μPAC-7186EX(D)-MTCP

Modbus/RTU to Modbus/TCP Gateway



Features:

- Incorporate Serial Devices in an Ethernet network
- Supports Modbus/TCP and Modbus/RTU
- "Virtual COM" extends PC COM ports
- 10/100 Base-TX (Auto-negotiating, auto MDI/MDI-X, LED indicator)
- Self-Tuner ASIC Controller on the RS-485 Port
- 5-digit LED Display (for versions with a display)
- Built-in High Performance MiniOS7 from ICP DAS
- Virtual COM for 32-bit and 64-bit Windows XP/2012/7/10
- Programmable Internet/Ethernet Controller
- Watchdog Timer suitable for use in harsh environments
- Power Reverse Polarity Protection Circuit
- RS-485 Port ESD Protection Circuit
- RoHS Compliant & no Halogen
- Low power consumption

μPAC-7186EX-MTCP μPAC-7186EXD-MTCP



Introduction:

The Modbus communications protocol has become the de facto industry standard, and is now the most commonly available means of connecting industrial electronic devices.

Modbus allows for communication between many devices connected to the same network, for example a system that measures temperature and humidity and communicates the results to a computer. Modbus is often used to connect a supervisory computer with a remote terminal unit (RTU) in supervisory control and data acquisition (SCADA) systems.

The μPAC-7186EX(D)-MTCP uses a default firmware to become a single Modbus/TCP to multiple Modbus/RTU converter. You can simply use the Modbus Utility to configure the device and then set the connection between the SCADA or HMI software and the μPAC-7186EX(D)-MTCP.

The μPAC-7186EX(D)-MTCP can also link to legacy serial devices that don't support Modbus/RTU. To use this function, you need to install the VxComm driver on the host PCs and create virtual COM ports for the remote serial ports on the μPAC-7186EX(D)-MTCP. You can then directly access the remote serial devices via the virtual COM ports.

Using the Modbus SDK, users can develop their own custom Modbus firmware, allowing extra functions and integration of serial devices. In this way, the μPAC-7186EX(D)-MTCP becomes a powerful controller.

The μPAC-7186EX(D)-MTCP contains a built-in operating system, the MiniOS7, which offers a stable and high performance environment that is similar to DOS. The MiniOS7 can boot up the μPAC-7186EX(D)-MTCP within just one second, with the added benefit of no virus problems and a small footprint. Furthermore, the μPAC-7186EX(D)-MTCP is designed for low power consumption, maintenance elimination (no hard disk and no fan), and is constructed from fire-retardant materials (UL94-V0 level) with a robust case.

I/O Expansion Bus and Expansion Board

The μPAC-7186EX(D)-MTCP supports a single I/O expansion bus for plugging with a X-board. ICP DAS provides many optional X-boards for the μPAC-7186EX(D)-MTCP, which offers various I/O functions, such as D/I, D/O, A/D, D/A, Timer/Counter, UART, flash memory, battery backup SRAM and AsicKey... etc.

Ordering Information:

Model No.	Description
μPAC-7186EX-MTCP CR	μPAC-7186EX with Default Modbus/TCP Firmware (RoHS)
μPAC-7186EXD-MTCP CR	μPAC-7186EXD with Default Modbus/TCP Firmware (RoHS)

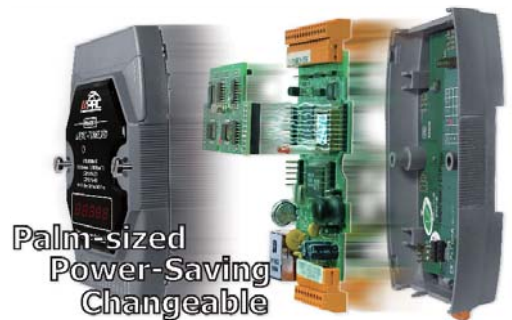
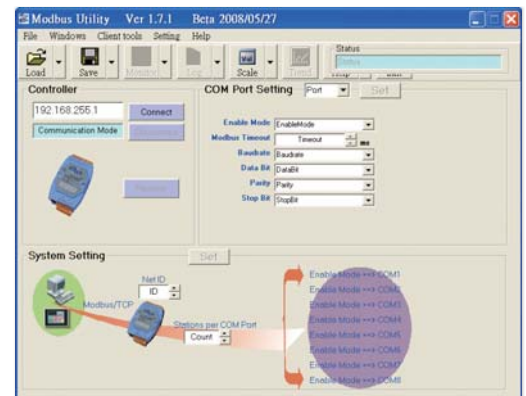

2.9 Modbus Data Concentrator, MDC-700 series

MDC-711

Modbus data concentrator with 1 × Ethernet and 1 × RS-232, 1 × RS-485

MDC-714

Modbus data concentrator with 1 × Ethernet and 1 × RS-232, 4 × RS-485

MDC-741

Modbus data concentrator with 1 × Ethernet, 4 × RS-232, 1 × RS-485



Features:

- Modbus Data Concentrator
- Config.CSV to Ease Hard Work of Editing a lot of Definition
- Great Capability of Shared Memory
- Web Sever to Ease the Operating and Show Clear Information

Introduction:

MDC-700 series is a Modbus Data Concentrator that has ability to perform up to 200 Modbus/RTU commands to read/write from/to Modbus slave devices via RS-232/485 and allows up to 8 Modbus/TCP masters to get the polled data via the Ethernet.

MDC-700 series provide a built-in web server to ease the configuring and provide clear information for the performed results of each Modbus/RTU command on the RS-232/485.

Modbus Data Concentrator

The MDC performs the pre-defined Modbus/RTU commands to read/write data from/to the Modbus/RTU slave devices via the RS-232/485. It mirrors the data of the slave devices to its own shared memory. And it accepts up to 8 Modbus/TCP masters to directly read/write data form/to the shared memory instead of polling each Modbus/RTU slave device one by one.

This way not only makes the data on the RS-232/485 sharable to multiple Modbus/TCP master but also shorten the time to read/write data from/to multiple Modbus/RTU slave devices.

Great Capability of Shared Memory

The MDC can perform up to 200 polling definitions. And the internal shared memory has four tables to store the polled AI, AO, DI and DO data. Each table can store up to 4000 registers.

Config.CSV to Ease Hard Work of Editing a lot of Definition

The Modbus polling definition is defined in a Config.CSV file. Editing/checking a lot of polling definitions is a hard work and may have chance to make a mistake. A CSV format file can ease the work by using Excel. Furthermore, the built-in web server allows users import/export the Config.CSV via a simple mouse-click action.

Web Sever to Ease the Operating and Show Clear Information

The IP address, configuration file, Config.CSV can be simply configured via the Web server. And the performed results of all Modbus polling definition are shown on the web page. It is very easy to debug which Modbus/RTU device has communication problem. And the MDC firmware will skip the abnormal Modbus polling definition for a while to smoothly perform the whole polling without distribution.

#	ComPortNo	BaudRate	DataBit	Parity	StopBit	TimeOut	PollDelay	Mode
1	1	115200	8	0	1	50	20	Master
2	2	115200	8	0	1	50	20	Master
3	3	9600	8	0	1	100	20	Master
4	4	9600	8	0	1	100	20	Master
5	5	9600	8	0	1	100	20	Master

Communication status between host PC and MDC-711: GOOD

Polling Definition

- COM1
 - Def. #001 - ID [01], Register [00000:00007] ⇒ Local Register [00000:00007] GOOD
 - Def. #002 - ID [01], Register [10000:10007] ⇒ Local Register [10000:10007] GOOD
- COM2
 - Def. #003 - ID [01], Register [00000:00003] ⇒ Local Register [00008:00011] GOOD
 - Def. #004 - ID [02], Register [10000:10003] ⇒ Local Register [10008:10011] GOOD
 - Def. #005 - ID [03], Register [40000:40003] ⇒ Local Register [40000:40003] GOOD
 - Def. #006 - ID [04], Register [30000:30003] ⇒ Local Register [30000:30003] GOOD

Applications:

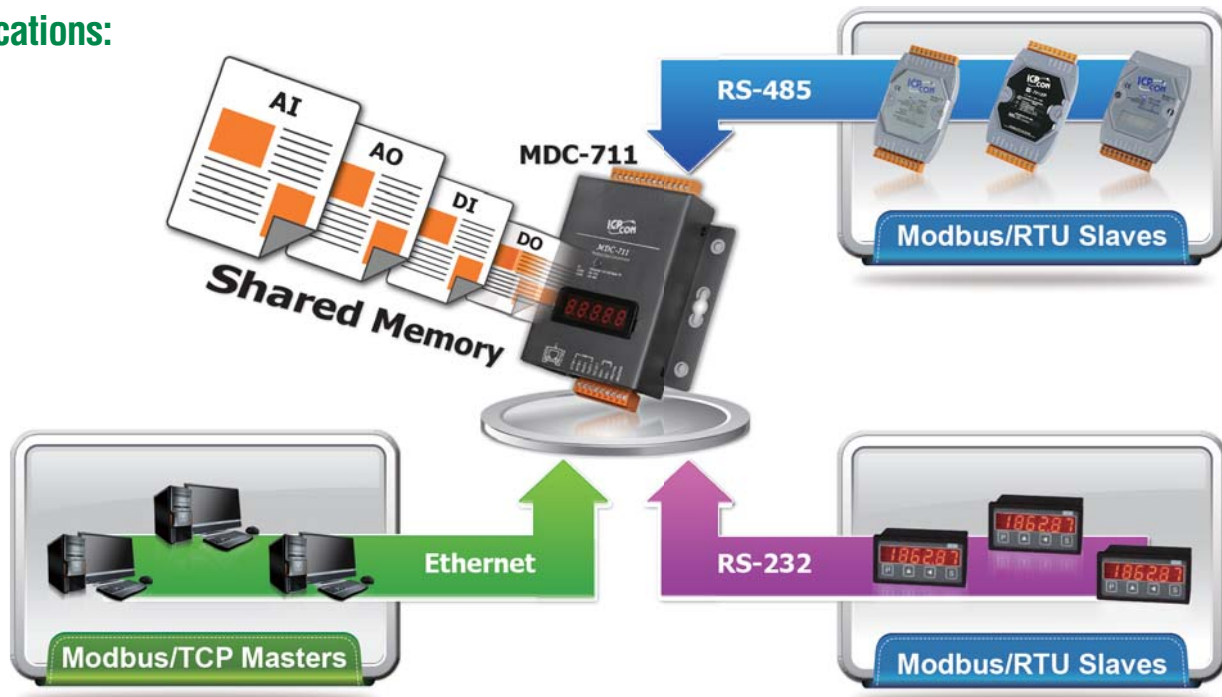

System Specifications:

Model Name	MDC-711	MDC-714	MDC-741
Ethernet			
Port	x1, 10/100 Base-TX		
Protocol	Modbus/TCP Slave		
Max. connection	8		
COM port			
RS-232	x1, (TXD, RXD, RTS, CTS, GND)		x4, (TXD, RXD, RTS, CTS, GND)
RS-485	x1, (Data+, Data-)	x4, (Data+, Data-)	
Baudrate	1200, 2400, 4800, 9600, 19200, 38400, 57600, 115200		
Data Format	N81, E81, O81		
Protocol	Modbus/RTU Master		
Max. Node	32 nodes for each RS-485 port		
Polling Definition	200 definitions for all RS-232/485 ports		
Shared Memory	4000 registers for each of AI, AO, DI and DO data		
System			
5-Digit 7 Segment LED Display	Yes, to display IP address		
System LED Indicator	Yes, to display hear beat		
Mechanical			
Dimension (W × H × D)	102 mm × 125 mm × 28 mm		
Installation	Wall Mount		
Power			
Required Supply Voltage	+10 VDC ~ +30 VDC (non-regulated)		
Power Consumption	2.5 W		
Environment			
Operating Temperature	-25°C ~ +75°C		
Storage Temperature	-40°C ~ +80°C		
Humidity	5 ~ 95% RH, non-condensing		

Ordering Information:

Model No.	Description
MDC-711 CR	Modbus data concentrator with 1 × Ethernet and 1 × RS-232, 1 × RS-485 (RoHS)
MDC-714 CR	Modbus data concentrator with 1 × Ethernet and 1 × RS-232, 4 × RS-485 (RoHS)
MDC-741 CR	Modbus Data Concentrator with 1 × Ethernet and 4 × RS-232, 1 × RS-485 (RoHS)

3. Converter/Repeater/Hub/Splitter



ICP DAS Self-Tuner ASIC Features:

- Multiple Baud Rate
- Multiple Data Format
- Automatic RS-485 Direction Control

"Self-Tuner"

A conventional RS-232 to RS-485 converter uses the DIP switch to select the baud rate and data format for the whole RS-485 network. All modules, devices and equipments in the network should be configured to the same baud rate and data format. Unfortunately most real world applications can't be implemented in such a simple way. The Self-Tuner is an innovative chip designed to solve this problem. Every converter contains a Self-Tuner chip. The chip automatically tunes the baud rate and data format to the whole network. Therefore the I-7520 can connect to modules, devices and equipments with different baud rates and data formats in a network.

Furthermore, the RS-485 is a 2 Wire half-duplex network. To transmit and receive data via the twisted pair wire, a transmission direction control for the RS-485 is needed. In conventional designs, software has to switch a hardware handshaking signal such as RTS (Request To Send) to control the transmission direction. The Self-Tuner chip automatically detects and controls the direction of the transmission of the RS-485 network. So the application program does not have to care about the direction control.

Self-Tuner Chip

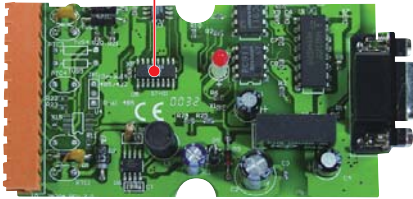

▲ I-7520

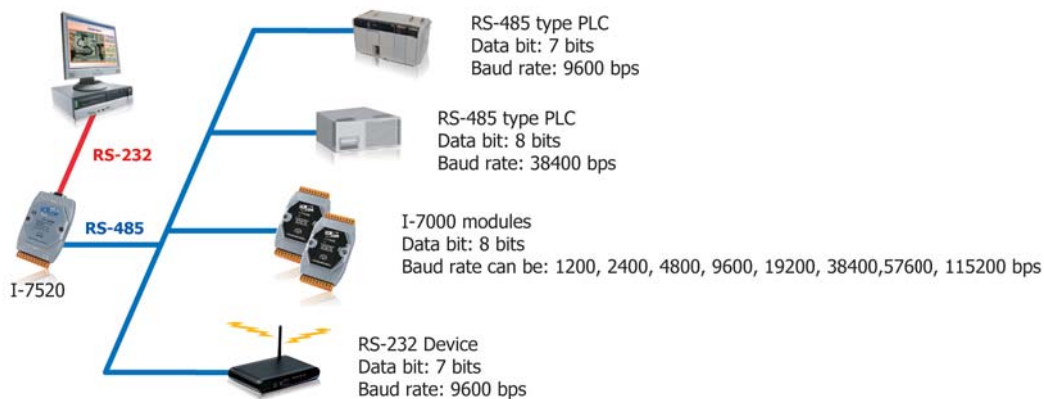

▲ I-7520U4

▲ I-7514U

High Quality Isolated RS-485 Repeater/Hub/Splitter

The maximum effective distance of RS-485 without repeater is 1200 meters (4000 feet) at baud rates up to 9.6 Kbps and up to 32 (256) nodes can be connected. With the professional design, the repeater I-7510 solves the problem of signal weakening and extends the maximum effective distance by 1200 m and connects 32 (256) nodes more. And it has optical isolation design for lightning and surge protection. If the RS-485 topology is too complex to make the communicating well, a RS-485 hub or splitter is recommended.

I-7520U4 and I-7514U are multichannel RS-485 repeater/hub/splitter. Each channel is independent and has optical isolation, short circuit and open circuit protection. Thus when one channel fails, it will not affect another channel of the hub. The features make it perfect to star type or mixed type topology in complex and large scale RS-485 network.

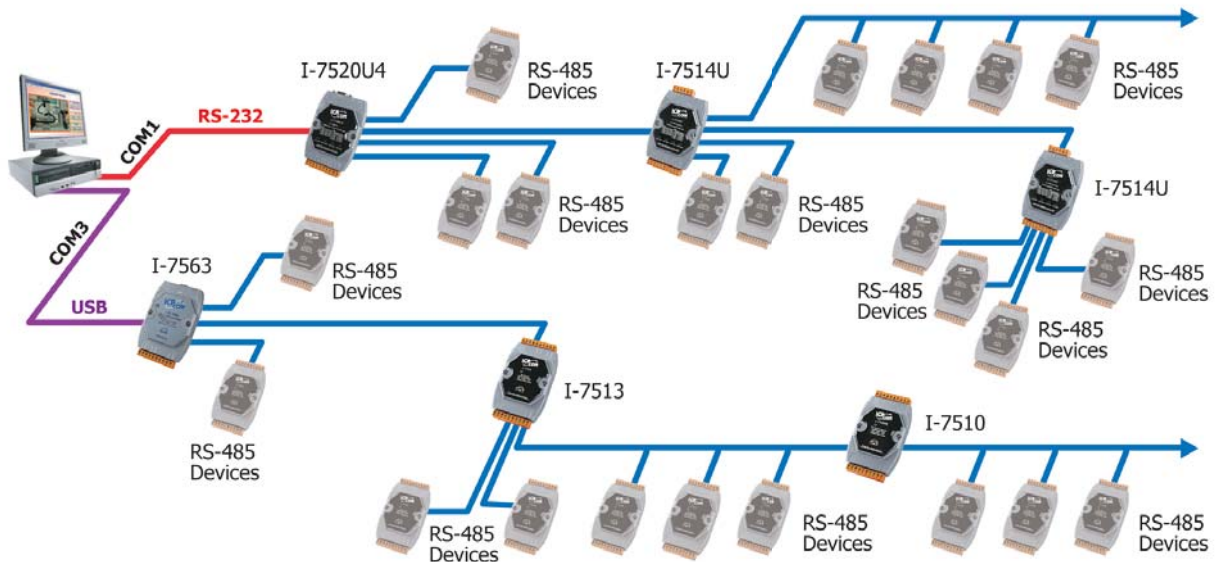

The following block diagram shows how I-7514U was designed as independent channel. Data coming from the master input will be transmitted to all four RS-485 slave channels. But data coming from the slave channels will be returned to the master input only. Thus reduces the possibility of interference between each RS-485 slave loop and makes the RS-485 networks more robust and reliable.

► I-7514U Block Diagram

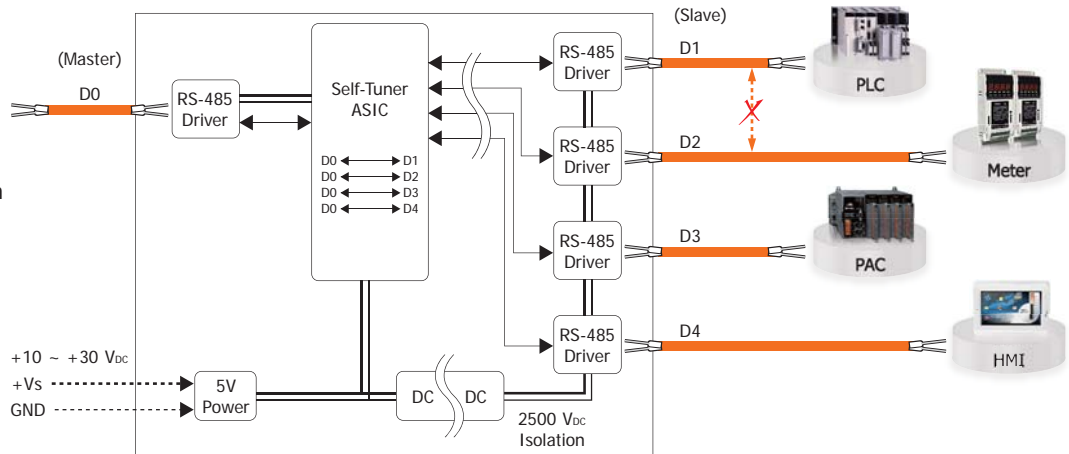

✓ RS-232/422/485 Converter/Repeater

Model Name	tM-7520U	I-7520	I-7520R	I-7520A	I-7520AR	I-7551	tM-7510U	I-7510	I-7510A	I-7510AR
Pictures										
Function	Converter						Repeater			
Interface	RS-232 to RS-485			RS-232 to RS-422/485		RS-232 to RS-232	RS-485	RS-485	RS-422/485	
Isolation	3000 VDC RS-232 side	3000 VDC RS-232 side	3000 VDC RS-485 side	3000 VDC RS-232 side	3000 VDC RS422/485 side	3000 VDC 3 ways	3000 VDC	3000 VDC		3000 VDC 3 ways
Operating Temperature	-25 ~ +75°C									

✓ USB to RS-232/422/485 Converter

Model Name	I-7560U	USB-2514	I-7561U	tM-7561
Pictures				
Function	Converter	Converter	Converter	Converter
Interface	USB to RS-232	USB to 4-Port RS-232	USB to RS-232/422/485	USB to RS-485
Isolation	-	-	3000 VDC	3000 VDC
Operating Temperature	-25 ~ +75°C			

✓ USB RS-232/485 to RS-485 Hub

Model Name	I-7563U	I-7513	I-7520U4	I-7514U
Pictures				
Function	3-Ch Hub/Splitter	3-Ch Hub/Splitter/Repeater	4-Ch Hub/Splitter	4-Ch Hub/Splitter/Repeater
Interface	USB to 3-Ch RS-485	RS-485 to 3-Ch RS-485	RS-232 to 4-Ch RS-485	RS-485 to 4-Ch RS-485
Isolation	3000 VDC	3000 VDC 3 ways	3000 VDC RS-232 side	3000 VDC Ch1-Ch4 side
Operating Temperature	-25 ~ +75°C			

4. Termination Resistor/DC Bias Voltage

tM-SG4

The RS-485 Bias and Termination Resistors Module



Features:

- Switch-selectable Bias Resistors
- 15-step Switch-selectable Termination Resistor
- LED Indicator for Power/Termination
- DIN-Rail Mountable
- Cost-effective
- Wide Operating Temperature Range: -25 ~ +75°C

Introduction:

The tM-SG4 is an optional module that is used to improve the communication of RS-485 network. It provides switch selectable bias resistors on RS-485 network. It also has 15-step switch selectable termination resistor such that the user can select a proper termination resistor to be connected to the RS-485 network easily. If the RS-485 network is not over 100 meters, the termination resistors are not needed. Otherwise, it may be necessary to insert two termination resistors at both end of the RS-485 network. It is not easy to calculate the value of a termination resistor on the RS-485 network. The best way to do this is to use an oscilloscope to check the RS-485 signal directly. If the impedance match of RS-485 network is OK, the oscilloscope will show a very nice square wave. If these square wave signals are distorted, the user will need to insert two termination resistors at both end of the RS-485 network.

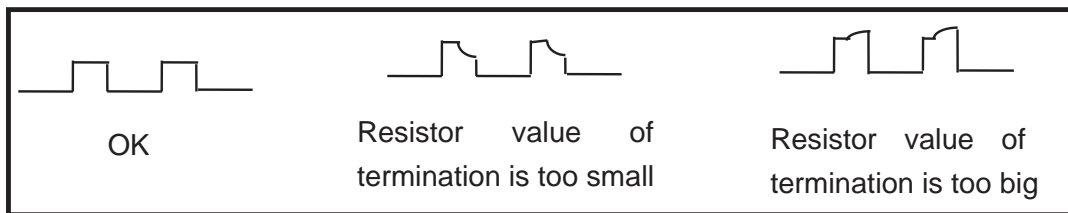

Applications:

Termination Resistor

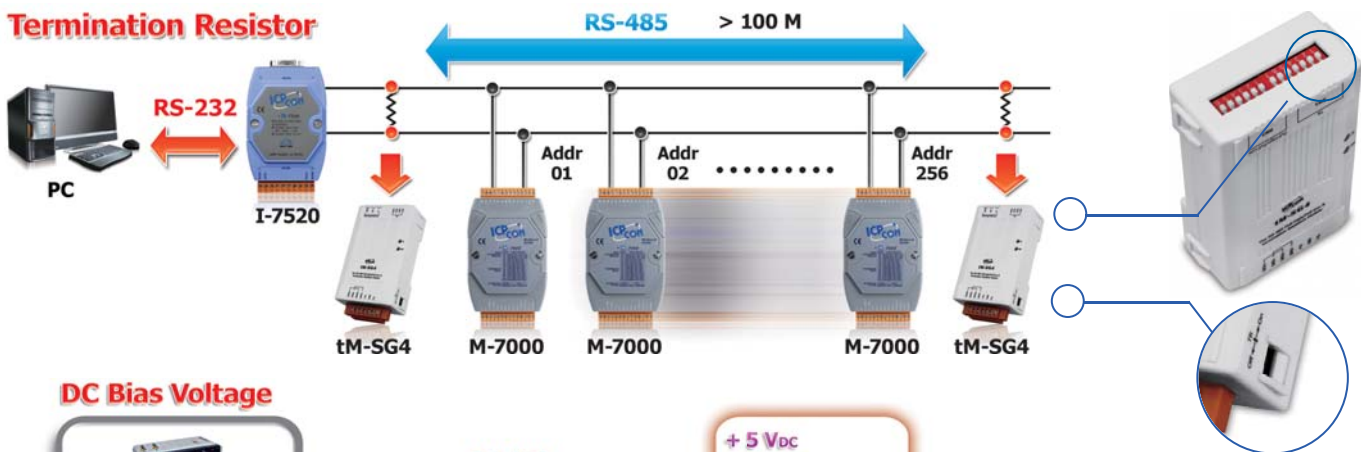

DC Bias Voltage

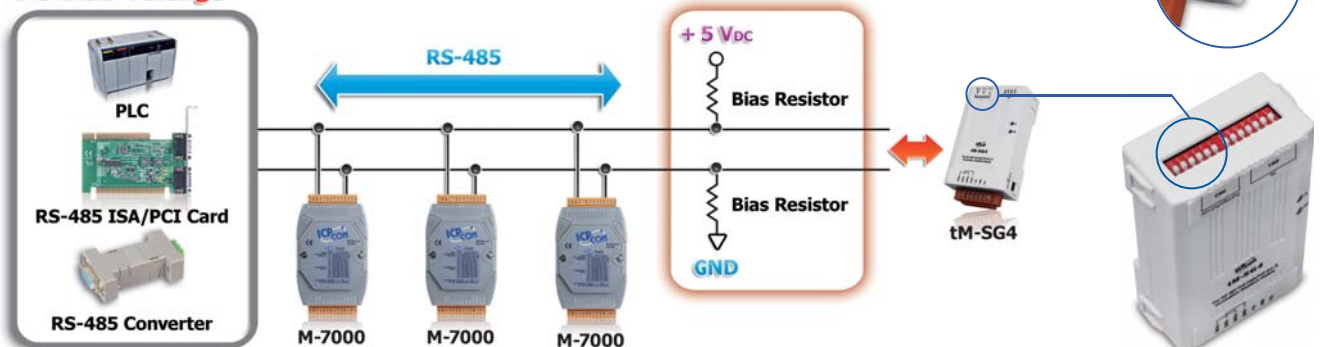

5. Ethernet Switch

✓ Unmanaged Ethernet Switch

Model Name	Speed	Port	Power Input	Housing
NS-105A	10/100 M	5	+12 ~ 53 VDC	Plastic
NS-205-IP67	10/100 M		+10 ~ 30 VDC, isolated	Plastic with IP67
NS-205AG	10/100/1000 M		+12 ~ 48 VDC	Plastic
NS-208AG/NSM-208AG	10/100M/1000 M	8	+12 ~ 48 VDC	Plastic/Metal
NS-208A/NSM-208A			+12 ~ 48 VDC	Plastic/Metal
NS-208-IP67			+12 ~ 53 VDC	Plastic with IP67
NSM-208-M12			+12 ~ 53 VDC	Metal with M12 connector
NSM-208-M12-IP67			+12 ~ 53 VDC	Plastic with M12 connector and IP67
NSM-216	10/100 M	16	+12 ~ 48 VDC	Metal
NSM-316G	10/100/1000 M		+12 ~ 48 VDC	Metal

✓ Unmanaged PoE Ethernet Switch

Model Name	Speed	Port	PoE Type (IEEE 802.3at)	Power Input	Housing
NS-105PSE	10/100 M	5	PSE x4	+46 ~ 55 VDC	Plastic
NS-205PSE-IP67	10/100 M			+46 ~ 53 VDC	Plastic with IP67
NSM-205GP	10/100/1000 M			+18 ~ 55 VDC	Metal
NS-208PSE/NSM-208PSE	10/100 M	8	PSE x8	+46 ~ 55 VDC	Plastic/Metal
NSM-208PSE-24V				+18 ~ 55 VDC	Metal
NSM-208PSE-M12				+46 ~ 53 VDC	Metal
NS-208PSE-M12-IP67				+46 ~ 53 VDC	Plastic with M12 connector and IP67
NS-208PSE-IP67				+46 ~ 53 VDC	Plastic with IP67

Appearance:

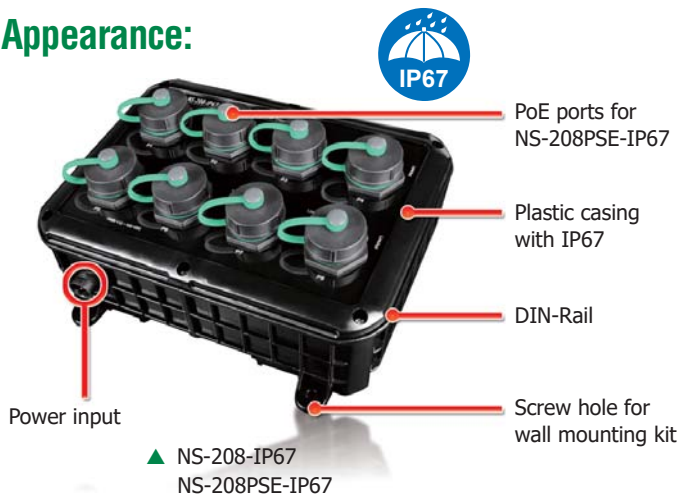



Real-time Redundant Ring Switch

Network topology refers to the way in which the network of switches and other network nodes is connected. In a Cyber-Ring network, every switch or network node has two adjacent neighbors for communication purposes. Cyber-Ring supports a variety of ring network topologies including Single Ring, Ring Coupling and Double Ring Coupling with fault-tolerant capability. The following sections describe in more detail the benefit of those topologies.

Features:

- 20 ms (typical) to detect and recover from a Ethernet link failure
- Automatic MDI / MDI-X crossover for plug-and-play
- Full duplex IEEE 802.3x and half duplex backpressure flow control
- Redundant Power Inputs with power failure alarm by relay out
- Store-and-forward architecture
- 3.2 Gbps high performance memory bandwidth
- 1 Mbit Frame buffer memory
- 1024/2048 MAC addresses

Dual Ring

The Dual Ring topology can connect separate Cyber-Ring network together (refer to figure 2). It is ideal for two-floor application scene. The Dual Ring topology not only construct individual Cyber-Ring network for each floor but also provide backup path to each other. It is a cost-effective solution to coupling ring topology.

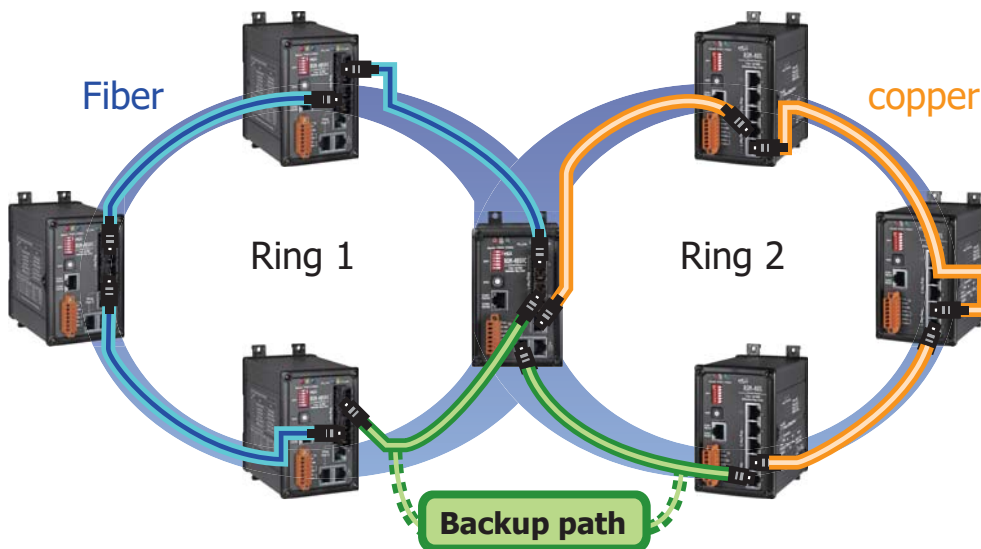

Solo Ring

A solo Ring network topology based on Cyber-Ring technology is a cost-effective solution to meet the requirements for link-loss backup in redundant network applications (refer to figure 4). Compared with other ring topology, Solo Ring is composed of ONE ring switch and unmanaged switches (NS series), there is some limit of this topology - longer recovery time and the ring switch is used to close ring topology only. The Solo Ring is most cost-effective redundant topology of Cyber-Ring technology.

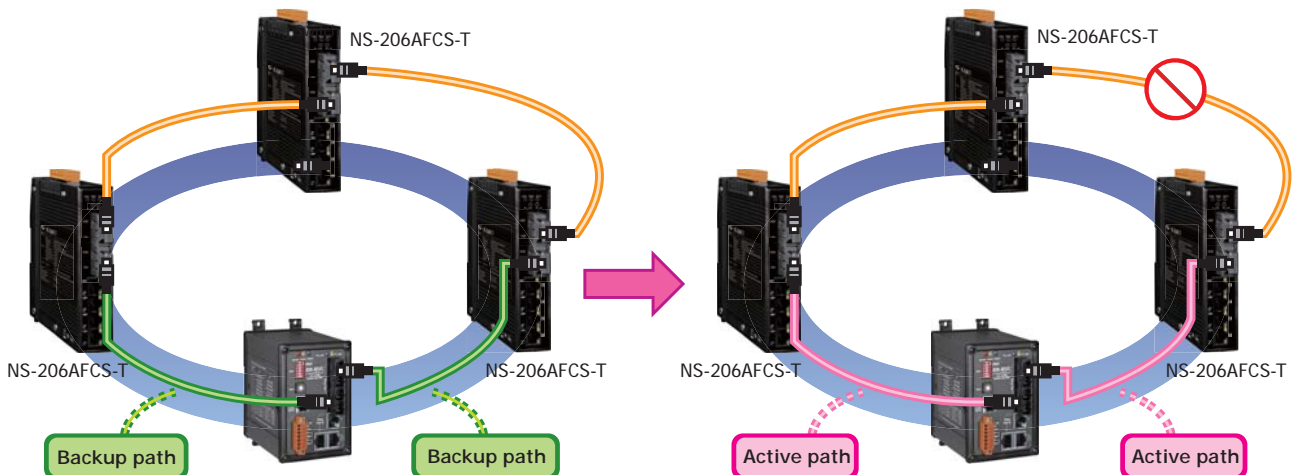

Single Ring

A Single Ring network topology based on Cyber-Ring technology is an effective solution to meeting the requirements for link-loss backup in industrial field applications. In normal operations, traffic on the backup path is either blocked or ignored, so that if there is a failure in any of the network nodes or within a cable segment on the active path, Cyber-Ring will automatically redirect the disrupted traffic to the backup path. After the affected path is repaired, the network will again be reconfigured to normal operational status

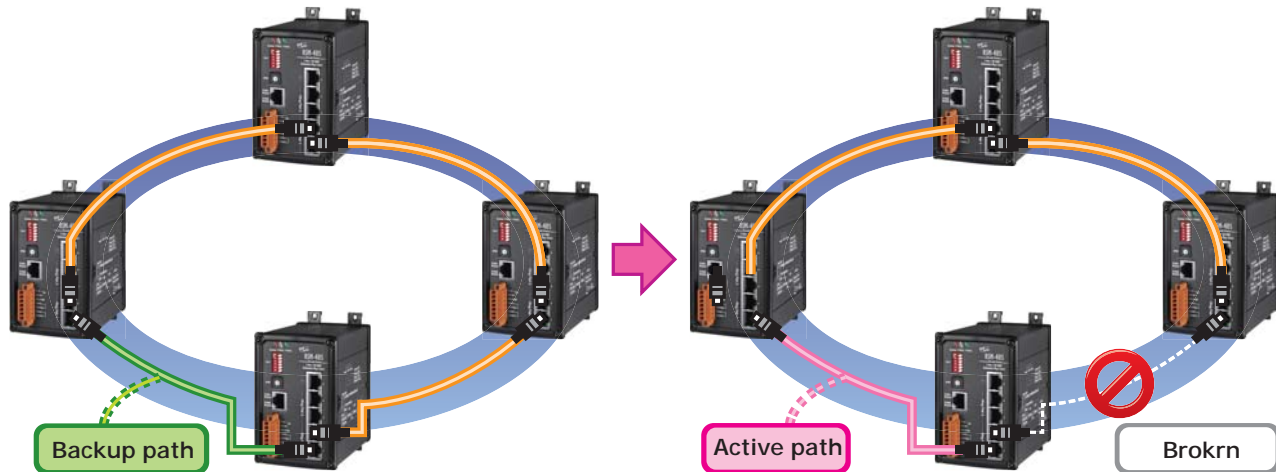

Real-time Redundant Ring Ethernet/Fiber Port Switch

Model Name	Ethernet		Fiber Port		Power Input	Housing	
	Speed	Port	Speed	Port			
RS-405/RSM-405		10/100 Mbps	5	–	–	+10 ~ 30 VDC	Plastic/Metal
RS-408/RSM-408		10/100 Mbps	8	–	–	+10 ~ 30 VDC	Plastic/Metal
RS-405F/RSM-405F Series		10/100 Mbps	3	100 Mbps	2	+10 ~ 30 VDC	Plastic/Metal
RSM-405-R		10/100 Mbps	5	–	–	+12 ~ 48 VDC	Metal

Model Name	Ethernet		Fiber Port				Power Input	Housing
	Speed	Port	Mode	Connector	Speed	Port		
MSM-508	10/100 Mbps	8	–	–	–	–	+12 ~ 48 VDC	Metal
MSM-508F Series	10/100 Mbps	6	–	–	100 Mbps	2	+12 ~ 48 VDC	Metal
FSM-510G-2F	10/100/1000 Mbps	8	SFP cage	LC	100/1000 Mbps	2	+12 ~ 48 VDC	Metal
FSM-510G-4F	10/100/1000 Mbps	6	SFP cage	LC	100/1000 Mbps	4	+12 ~ 48 VDC	Metal
FSM-6228G-DC	10/100/1000 Mbps	24	SFP cage	LC	100/1000 Mbps	4	+12 ~ 48 VDC	Metal
FSM-6228G-AC	10/100/1000 Mbps	24	SFP cage	LC	100/1000 Mbps	4	100 ~ 240 VAC	Metal

8-port Industrial Ethernet Layer 2 Managed Switch

MSM-508



The MSM-508 is an 8-port Industrial Ethernet (10/100 Base-TX) Layer 2 Managed Switch. MSM-508 supports 10/100M auto negotiation feature and auto MDI/MDI-X function.

- 3.2 Gbps high performance memory bandwidth
- Redundant Power Inputs +12 VDC ~ +48 VDC
- Each port supports both 10/100 Mbps speed auto negotiation
- Full duplex IEEE 802.3x and half duplex backpressure flow control
- Operating temperature range: -40°C ~ +75°C
- Store-and-forward architecture
- Frame buffer memory: 1 Mbit
- Supports 2K MAC Addresses
- Power failure alarm by relay output

8-port Industrial Ethernet Layer 2 Managed Switch with 2-Fiber Port

MSM-508F Series



The MSM-508F series is an 8-port Industrial Ethernet Layer 2 Managed Switch with 2-Fiber Port that secures data transmission by using fiber optic transmission to provide immunity from EMI/RFI interference.

- 3.2 Gbps high performance memory bandwidth
- Redundant Power Inputs +12 VDC ~ +48 VDC
- Each port supports both 10/100 Mbps speed auto negotiation
- Full duplex IEEE 802.3x and half duplex backpressure flow control
- Operating temperature range: -30°C ~ +75°C
- Store-and-forward architecture
- Frame buffer memory: 1 Mbit
- Supports 2K MAC Addresses
- Power failure alarm by relay output

NEW

6-Port 10/100/1000 Base-T + 4 SFP Port L2 Managed Switch 8-Port 10/100/1000 Base-T + 2 SFP Port L2 Managed Switch

FSM-510G Series



FSM-510G-4F is a L2 Managed Switch that meets all IEEE 802.3ab/u/x/z Gigabit, Gigabit Ethernet and Ethernet specifications. It provides 6 gigabit Ethernet ports (10/100/1000 Mbps TP) 4 SFP ports.

The switch can be managed through RS-232 serial port via direct connection, or through Ethernet port using Telnet or Web-Based management unit, associated with SNMP agent. With the SNMP agent, the network administrator can logon the switch to monitor, configure and control each port activity in a friendly way. The overall network management is enhanced and the network efficiency is also improved to accommodate high bandwidth applications. In addition, the switch features comprehensive and useful function such as DHCP Option 82, QoS (Quality of Service), Spanning Tree, VLAN, Port Trunking, Bandwidth Control, Port Security, SNMP/RMON

- Network redundant Ring fail-over protection (< 20 ms)
- Multicasting support IGMP v1/v2, proxy & snooping
- L2+ features provide better manageability, security, QoS, and performance
- IEEE 802.3ab 1000BASE-T Gigabit Ethernet
- Multicast/Broadcast/Flooding Storm Control

NEW

24-port Ethernet + 4 SFP Layer 2 Gigabit Managed Switch

FSM-6228G-AC
FSM-6228G-DC

FSM-6228G is a L2 Managed Switch that meets all IEEE 802.3ab/u/x/z Gigabit, Gigabit Ethernet and Ethernet specifications. It provides 24 gigabit Ethernet ports (10/100/1000 Mbps TP) 4 SFP ports.



The switch can be managed through RS-232 serial port via direct connection, or through Ethernet port using Telnet or Web-Based management unit, associated with SNMP agent. With the SNMP agent, the network administrator can logon the switch to monitor, configure and control each port activity in a friendly way. The overall network management is enhanced and the network efficiency is also improved to accommodate high bandwidth applications. In addition, the switch features comprehensive and useful function such as QoS (Quality of Service), Spanning Tree, VLAN, Port Trunking, Bandwidth Control, Port Security, SNMP/RMON.

- Network redundant Ring fail-over protection (< 20 ms)
- Multicasting support IGMP v1/v2/v3, proxy & snooping
- L2+ features provide better manageability, security, QoS, and performance
- IEEE 802.3ab 1000BASE-T Gigabit Ethernet
- Multicast/Broadcast/Flooding Storm Control

Accessories		
	SFP-1G85M-SX	Multi-mode 850 nm, 0.5 km SFP module
	SFP-1G13M-SX2	Multi-mode 1310 nm, 2 km SFP module
	SFP-1G13S-LX	Single-mode 1310 nm, 10 km SFP module
	SFP-1G13S-LX20	Single-mode 1310 nm, 20 km SFP module
	SFP-1G13S-LHX	Single-mode 1310 nm, 40 km SFP module
	SFP-1G15S-XD	Single-mode 1550 nm, 60 km SFP module

PoE Splitter/Injector

A PoE splitter makes the exact invert operation: by the means of a PoE splitter, the power and the data received on the Ethernet cable are split. The power can then be used to power any other electrical device present in the application.

A PoE injector enables the powering of a PoE compatible device over Ethernet in spite of a non PoE capable Ethernet Switch. The PoE injector, placed between the Ethernet switch and the PoE powered device, merges both data (Ethernet Port) and voltage (power connector) on the Ethernet cable.

Model Name	Speed	Input	Output	Housing
NS-200PS	10/100/1000 Mbps	PoE	Ethernet + 24 VDC	Plastic
tNS-200IN	10/100 Mbps	Ethernet + 48 VDC	PoE	Plastic
tNS-200IN-24V	10/100 Mbps	Ethernet + 24 VDC	PoE	Plastic





Industrial Media Converters & WDM Media Converter

A Media Converter is a simple and low-cost networking device which allows connect two dissimilar media types such as an Ethernet cable with fiber optic, even though transmission speed are different. It is a perfect add-on to an Ethernet switch when combining copper and fiber within the Ethernet Network. Multiple cabling types such as coax, twisted pair, multi-mode and single-mode fiber optics are supported.



Model Name	Fiber Port		Ethernet		Operation temperature	Power Input	Housing
	Speed	Port	Speed	Port			
NS-200F series	100 M	1	10/100 M	1	0 ~ +70°C	+10 ~ 30 VDC	Plastic
NS-200WDM	100 M	1	10/100 M	1	0 ~ +70°C	+12 ~ 48 VDC	Plastic
NS-200AF series	100 M	1	10/100 M	1	-30 ~ +75°C	+12 ~ 48 VDC	Plastic
NSM-200G-SFP NSM-200SX/SX2/LX	1000 M	1	10/100/1000 M	1	-30 ~ +75°C	+12 ~ 48 VDC	Metal



Unmanaged Ethernet Switch with Fiber Ports

An unmanaged industrial Ethernet switch with fiber port(s) provides both Ethernet switch functionality (up to 8 RJ45 ports) and media converter (up to 2 fiber ports) for safe and fast local and long distance (max 60 km) transmissions. Each switch is plug and play, can be installed on DIN-Rail, and supports wide operating temperature range.



Model Name	Fiber		Ethernet			Power Input	Housing
	Speed	Port	Speed	Port	PSE (IEEE 802.3af)		
NS-205AF Series NSM-205AF Series	100 M	1	10/100 M	4	-	+12 ~ 48 VDC	Plastic/Metal
NS-205PF Series NSM-205PF Series	100 M	1	10/100 M	4	4	+12 ~ 48 VDC	Plastic/Metal
NS-206AF Series NSM-206AF Series	100 M	1	10/100 M	4	-	+12 ~ 48 VDC	Plastic/Metal
NS-209F Series NSM-209F Series	100 M	1	10/100 M	8	-	+12 ~ 48 VDC	Plastic/Metal
NSM-210C	1000 M RJ-45/SFP combo ports	2	100/100 M	8	-	+12 ~ 48 VDC	Metal

6. Fieldbus Solution

6.1 EtherNet/IP Gateways

Model Name	Description	
EtherNet/IP Gateways	GW-7472	Ethernet/IP Adapter to Modbus TCP/RTU Master Gateway
	GW-7473	Modbus TCP/RTU Slave to EtherNet/IP Scanner Gateway

NEW

EtherNet/IP Adapter to Modbus TCP/RTU Master Gateway

GW-7472

The GW-7472 (EtherNet/IP adapter to Modbus TCP/RTU Master Gateway) is helpful for data-exchanging between the Modbus RTU Network, Modbus TCP Network, and the EtherNet/IP Network. It reads the register data from the Modbus RTU slaves as well as Modbus TCP servers and publishes these data to the input register data of the EtherNet/IP scanner. The output data transmitted by the EtherNet/IP scanner are updated to the register data of Modbus TCP/RTU slaves via the GW-7472.



Modbus Features >>>

- Maximum support 8 Modbus commands for each one Modbus TCP server
- Modbus Input/Output command data size: maximum 500 bytes
- Supported Modbus Function Code 01, 02, 03, 04, 05, 06, 15, and 16
- Modbus Protocol: Modbus TCP/RTU master protocols
- Maximum support 30 Modbus RTU commands
- Maximum support 10 Modbus TCP servers

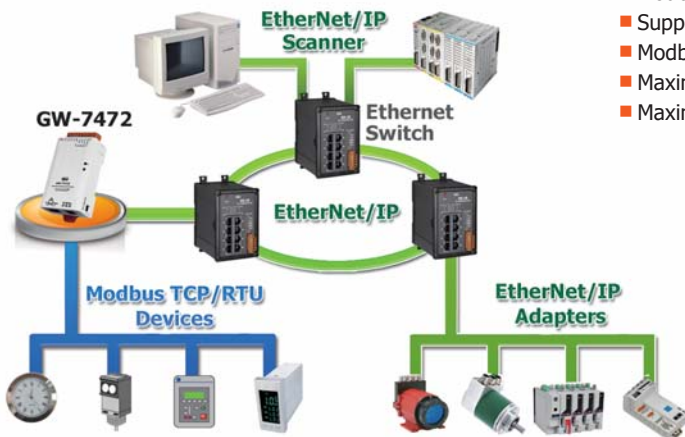

EtherNet/IP Features >>>

- Ethernet Protocol: EtherNet/IP adapter
- Maximum number of connections for Explicit Messages: 6
- Maximum number of connections for Implicit Messages: 1
- EtherNet/IP Input/Output command data size: maximum 500 bytes
- Supported I/O connection methods:
 - ★ Transport and trigger: Exclusive-Owner, Cyclic
 - ★ Originator to Target Type: POINT2POINT
 - ★ Target to Originator Type: POINT2POINT, MULTICAST

NEW

Modbus TCP/RTU Slave to EtherNet/IP Scanner Gateway

GW-7473

The GW-7473 (Modbus TCP/RTU Slave to EtherNet/IP Scanner Gateway) is helpful for data-exchanging between Modbus Master and EtherNet/IP adapter. It reads the register data from the EtherNet/IP adapter and publishes these data to the input register data of the Modbus TCP client as well as Modbus RTU Master. The output data transmitted by the Modbus TCP/RTU Master are updated to the register data of EtherNet/IP adapter.



Modbus Features >>>

- Modbus Protocol: Modbus TCP Server/RTU Slave protocols
- Supported Modbus Function Code 01, 02, 03, 04, 05, 06, 15, and 16
- Maximum support 5 Modbus TCP clients

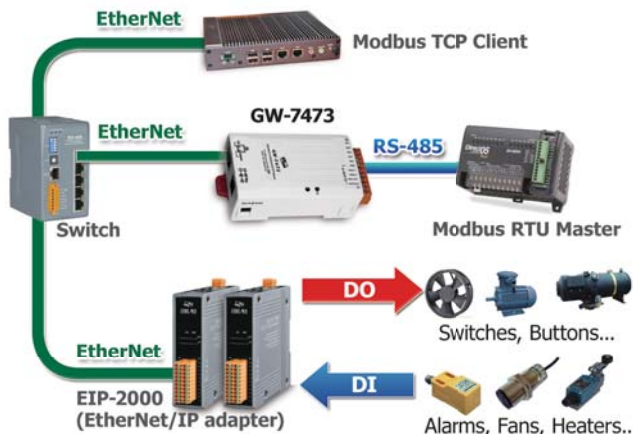

EtherNet/IP Features >>>

- Supported Objects according to CIP Standard
 - ★ Assembly Object
 - ★ Connection Manager Object
 - ★ Ethernet Link Object
 - ★ Message Router Object
 - ★ TCP/IP Interface Object
- Ethernet Protocol: EtherNet/IP Scanner
 - ★ Class 1 (connected) I/O Server and Client
 - ★ Maximum support 5 EtherNet/IP adapter connections
 - ★ EtherNet/IP I/O command data size: 200 bytes

6.2 BACnet Gateways

Model Name		Description
BACnet/IP Gateway	GW-5492	BACnet/IP Server to Modbus RTU Master Gateway
	GW-5493	BACnet/IP Server to Modbus TCP Client Gateway
BACnet/IP I/O Modules	BNET-5304	BACnet/IP I/O Module with 6-Ch AI, 1-Ch AO, 4-Ch DI, 4-Ch DO
	BNET-5310	BACnet/IP I/O Module with 4-Ch AI, 2-Ch AO, 3-Ch DI, 3-Ch DO

BACnet/IP Server to Modbus Master Gateway

GW-5492 GW-5493



GW-5492 and GW-5493 is a fully configurable universal BACnet/IP to Modbus RTU/TCP gateway. The GW-549x includes BACnet/IP Server and Modbus RTU Master (GW-5492) or TCP Client (GW-5493) which is used to make Modbus devices accessible on a BACnet network. BACnet (Building Automation and Control Networking) protocol has been designed specifically to meet the communication needs of building automation and control systems for applications such as heating, ventilating. The GW-549x contains a large number of BACnet objects gives you flexibility in mapping Modbus registers to any combination of BACnet objects. Multiple BIBBs are supported. All the data transfer is configurable using a standard Web browser.

BACnet/IP I/O Module with 6-Ch AI, 1-Ch AO, 4-Ch DI, 4-Ch DO

BNET-5304





The BNET-5304 is a multi-function BACnet/IP module with 6 AI channels, 1 AO channel, 4 DI channels and 4 DO channels. The module contains number of BACnet objects including Device, AI, AO, BI, and BO with multiple BIBBs (DS-RP-B, DS-RPM-B, DS-WP-B, DS-WPM, DS-COV-B...etc.) supported. The modules also feature a built-in web server which allows remote configuration by using a regular web browser for an easy and safe access at any time anywhere.

BACnet/IP I/O Module with 4-Ch AI, 2-Ch AO, 3-Ch DI, 3-Ch DO

BNET-5310



The BNET-5310 is a multi-function BACnet/IP module with 4 AI channels, 2 AO channel, 3 DI channels and 3 DO channels. The module contains number of BACnet objects including Device, AI, AO, BI, and BO with multiple BIBBs (DS-RP-B, DS-RPM-B, DS-WP-B, DS-WPM, DS-COV-B...etc.) supported. The modules also feature a built-in web server which allows remote configuration by using a regular web browser for an easy and safe access at any time anywhere.

Model Name		BNET-5304	BNET-5310
		Multi-function BACnet/IP Module	Multi-function BACnet/IP Module
Pictures			
Communication	Ethernet	10/100 Base-TX	
	Security	ID and Password	
Protocol	BACnet	BACnet/IP	
	BACnet Object	1 Device, 6 AI, 1 AO, 4 BI, 4 BO	1 Device, 4 AI, 2 AO, 3 BI, 3 BO
	BIBB	DS-RP-B, DS-RPM-B, DS-WP-B, DS-WPM-B, DS-COV-B, DM-DDB-B, DM-DOB-B, DM-DCC-B, DM-TS-B, DM-UTC-B, DM-RD-B	
Analog Input	Channel	6, single-ended	4, differential
	Range	±5 V, 0 ~ 5 V	±10 V
Analog Output	Channel	1	2
	Range	±5 V	±10 V
Digital Input	Channel	4, Dry Contact	3, Dry Contact
Digital Output	Channel	4, Open Collect, Sink	3, Open Collect, Sink

6.3 CAN Bus Repeater/Bridge/Switch

The CAN Bus Repeater/Bridge/Switch is used to enhance the signal quality, extend the communication distance, isolate CAN Bus network. ICP DAS provides following products.



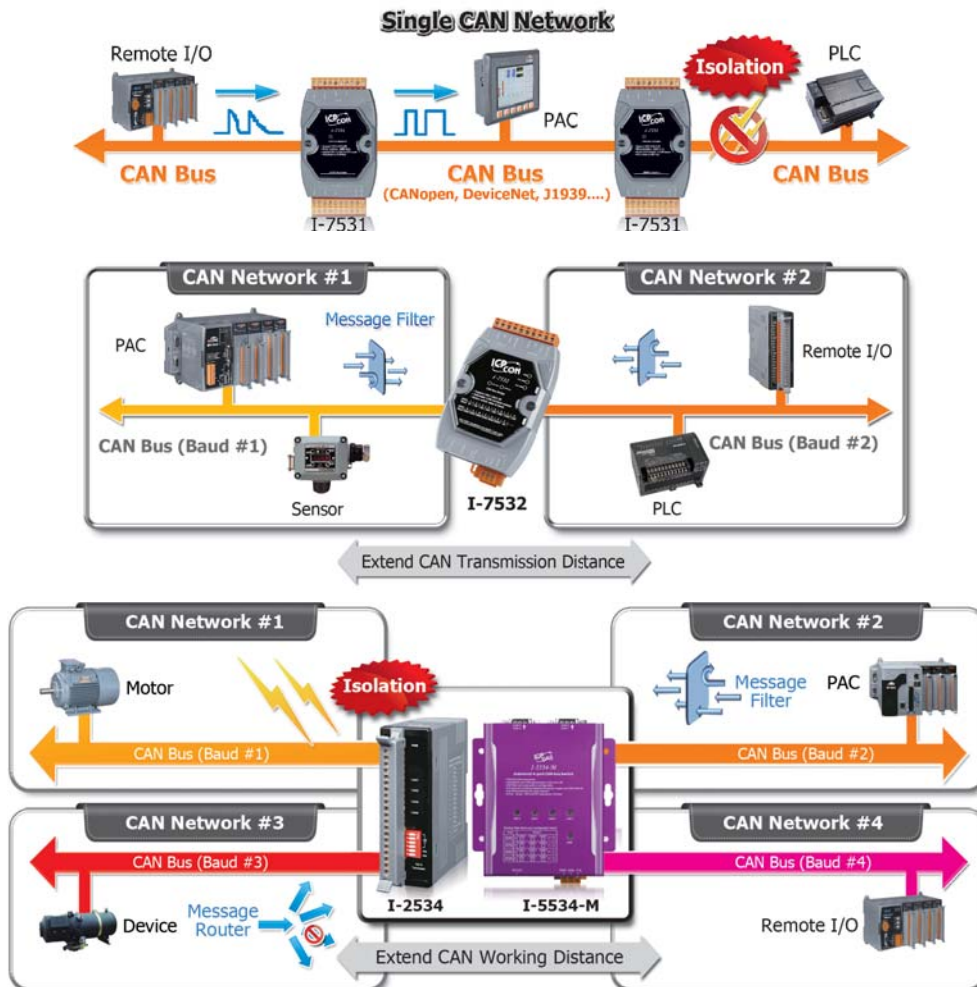



Model Name	I-7531	I-7532	I-2534	I-5534-M
	Isolated CAN Bus Repeater	Isolated Two-channel CAN Bus Bridge	4-Port CAN Bus Switch	4-Port CAN Bus Switch with Metal Casing
Pictures				
CAN Interface				
Transceiver	NXP 82C250		NXP TJA1042	
Channel number	2		4	
Connector	3-pin screwed terminal block (CAN_GND, CAN_L, CAN_H)	4-pin screwed terminal block (CAN_GND, CAN_L, CAN_SHLD, CAN_H)	9-pin male D-Sub with CAN_GND, CAN_SHLD, CAN_H, CAN_L	
Transmission speed (bps)	5 k ~ 800 k with auto baud rate detection	5 k ~ 1 M selected by rotary switch or utility tool		
Transmission Distance (m)	Depends on the CAN baud rate		Duplicates the transmission distance depended on the CAN baud rate	
Propagation Delay	Max. 200 ns (shortens the transmission distance by ~ 40 m)	Depends on the CAN baud rate (Max. 134 us @ 1 Mbps)	Depends on the CAN baud rate (Max. 440 us @ 1 Mbps)	
Terminator Resistor	Jumper for 120 Ω terminator resistor		DIP switch for the 120 Ω terminator resistor	Jumper for 120 Ω terminator resistor
Isolation	3000 Vdc for DC-to-DC, 2500 Vrms for photo-couple			
Specification	ISO 11898-2, CAN 2.0A and CAN 2.0B			







6.4 USB to CAN Converters



The I-7565 series is the USB to CAN converter with a maximum of two independent CAN channels that supports CAN protocols 2.0A and 2.0B. It becomes very convenient and easy to access and control the CAN devices via the USB port of the PC.

Model Name	I-7565	I-7565-H1	I-7565-H2	I-7565M-HS	I-7565-CPM	I-7565-DNM
Pictures	1-Port Cost Effective USB to CAN Converter 	1-Port High Performance USB to CAN Converter 	2-Port High Performance USB to CAN Converter 	2-Port High Performance USB to CAN Converter 	Intelligent USB to CANopen Converter 	Intelligent USB to DeviceNet Converter 
USB Interface						
Connector	USB Type B					
Compatibility	USB 1.1 and 2.0 standard					
Compatibility						
Channel	1	1	2	2	1	1
Transceiver	Philips 82C250	NXP TJA1042			NXP 82C250	NXP 82C250
Connector	9-pin male D-Sub		10-pin terminal block	8-pin terminal block	9-pin male D-Sub	
Baud Rate (bps)	10 k, 20 k, 50 k, 100 k, 125 k, 250 k, 500 k, 800 k, 1M					125 k, 250 k, 500 k
Isolation	3000 Vrms				3000 VDC	
Terminator Resistor	Selectable 120 Ω terminator resistor by a jumper					
Protocol	CAN 2.0A/2.0B				CiA 301 V4.02	DeviceNet Volume I ver2.0, Volume II ver2.0
Receive Buffer (frame)	1000	256	128 for each CAN port	256 for each CAN port	1000	256
Max. Data Flow (fps)	250	3000	1500 fps for each CAN port	10000 fps for each CAN port	-	-

6.5 CAN to Fiber Converter/Bridge

Models	I-2532	I-2533	I-2533CS	I-2533CS-60	I-2533CS-A/I-2533CS-B
Pictures	CAN to Multi-mode Fiber Converter 		CAN to Single-mode Fiber Bridge    		
CAN Interface					
Connector	Screwed terminal block (CAN_GND, CAN_L, CAN_H)				
Baud Rate (bps)	10 k ~ 500 k	10 k ~ 1 M			
Transmission Distance (m)	Depends on baud rate				
Propagation Delay	Max 125 ns	Max. 125 μs (depends on the CAN baud rate)			
Terminator Resistor	DIP switch for the 120 Ω terminator resistor				
Isolation	3000 Vdc for DC-to-DC, 2500 Vrms for photo-couple				
Specification	ISO 11898-2, CAN 2.0A and CAN 2.0B				
Fiber Interface					
Connector	ST Type		SC Duplex (Single-mode)		SC Type
Wave Length (nm)	850		1300 or 1310		TX: 1310, RX: 1550 for I-2533CS-A TX: 1550, RX: 1310 for I-2533CS-B
Fiber Cable (μm)	Multi-mode 50/125, 62.5/125 or 100/140		Single-mode 8.3/125, 8.7/125, 9/125 or 10/125		
Transmission Distance	Max. 1.4 km	Max. 2 km	Max. 30 km	Max. 60 km	Max. 15 km
UART Interface					
COM1	RS-232 (for configuration)				
COM 1 Connector	3-pin screwed terminal block (RxD, TxD, GND)				
Transmission Speed (bps)	115200				
Data bit	8				
Stop bit	1				
Parity	None				

6.6 Ethernet/Wi-Fi to CAN Converters

Model Name	Description	
Ethernet/Wi-Fi to CAN Converter	I-7540D-MTCP	Modbus TCP to CAN Converter
	ECAN-240	Modbus TCP Client/Server to two CAN ports Gateway
	I-7540D	Ethernet to CAN Converter
	I-7540D-WF	Wi-Fi to CAN Converter

Modbus TCP to CAN Converter

I-7540D-MTCP



Inheriting to the most of all features of the I-7540D, the I-7540D-MTCP enables CAN networks to be combined with the Internet/Ethernet. It can be used to not only access the CAN network via the Ethernet, but can also realize Ethernet transparent transmission on the CAN network. In order to connect the PLCs, HMIs and SCADAs with the CAN devices more easily and conveniently, the I-7540D-MTCP supports the Modbus TCP and Modbus RTU communication protocol. This module can act as a Modbus TCP server, and wait for the commands from the Modbus TCP client. When the controller is a Modbus RTU master, the I-7540D-MTCP is able to be the Modbus RTU slave, and transfer the Modbus RTU commands to the CAN messages. These features mean that users can setup their applications more flexibly and conveniently.

- Compatible with CAN specification 2.0 parts A and B
- Fully compatible with the ISO 11898-2 standard
- Supports a range of baud rates from 10 kbps ~ 1 Mbps
- Support maximum 24 Ethernet clients connection
- Support 30 specific CAN IDs in the Modbus TCP/RTU mode
- Provide the transparent communication between the CAN devices via Ethernet
- Provides one channel each for CAN, RS-232, RS-485 and 10/100 Base-T Ethernet

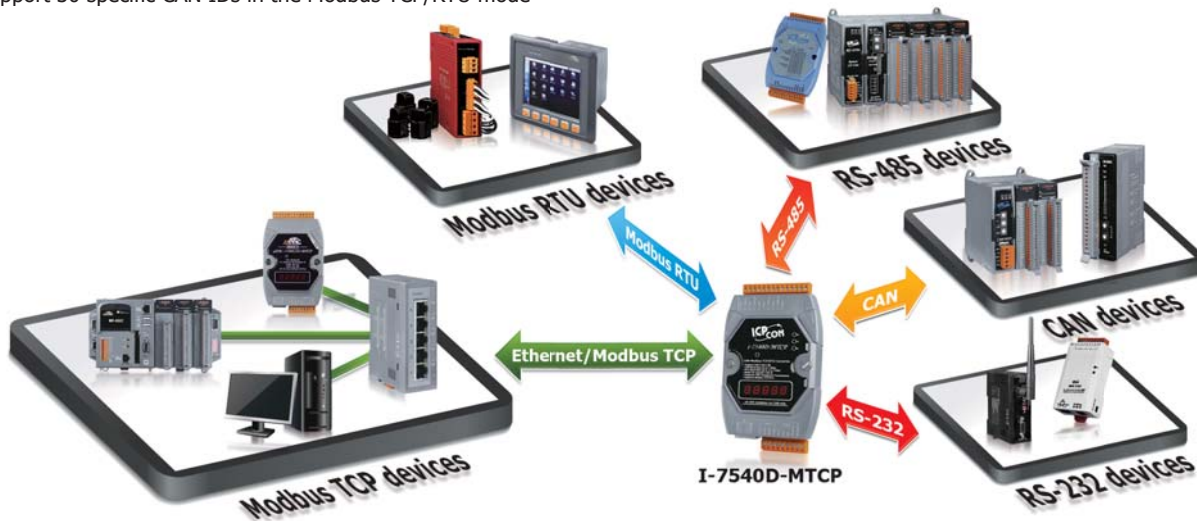

NEW

Modbus TCP Client/Server to two CAN ports Gateway

ECAN-240



ECAN-240 is a Ethernet to CAN two ports Gateway. Users can communicate with different CAN networks at the same time. In order to be used more easily in industry, the ECAN-240 supports Modbus TCP client and Modbus TCP server function. Users can choose one of them for fitting their application.

Furthermore, the two CAN ports have different purposes according to their usages. For example: In pair connection mode, the different CAN networks can be communicated with each other via module configuration.



Ethernet to CAN Converter

I-7540D



The I-7540D is a CAN to Ethernet converter, and is usually applied as an Ethernet to CAN/RS-232/485 Device Server. It supports socket access functions and virtual COM port technology which helps users to get the CAN, RS-232, RS-485 data via virtual COM port. The I-7540D also provides transparent mode, which enables CAN networks to be coupled together over the Internet/Ethernet, whereby remote monitoring and control is possible. By the features of tiny operating system, protocol independence, small casing and flexibility, it is able to widely fit various RS-232, RS-485 and CAN applications, which may be based on private RS-232 protocol, private CAN protocol, Modbus RTU protocol, CANopen protocol, DeviceNet protocol or J1939 protocol.

- Provide the transparent communication between the CAN devices via Ethernet
- Provide one channel each for CAN, RS-232, RS-485 and Ethernet
- Provides connections for a maximum of 25 Ethernet clients
- Supports a range of baud rates from 10 kbps ~ 1 Mbps
- Jumper for the 120 Ω terminator resistor of the CAN bus
- Compatible with CAN specification 2.0 parts A and B
- 2500 Vrms photocoupler isolation on the CAN side
- Fully compatible with the ISO 11898-2 standard
- Supports the Virtual COM technology
- 10/100 Base-T Ethernet port

Extend CAN communication distance

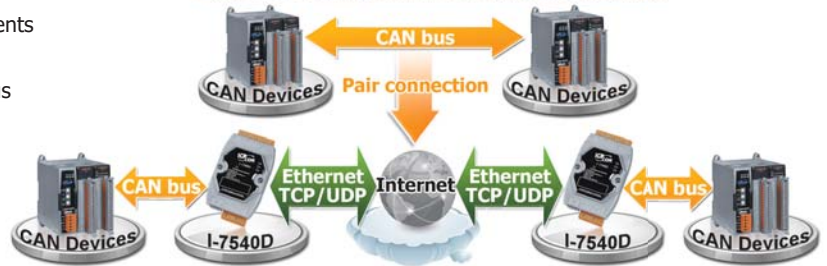

General Application

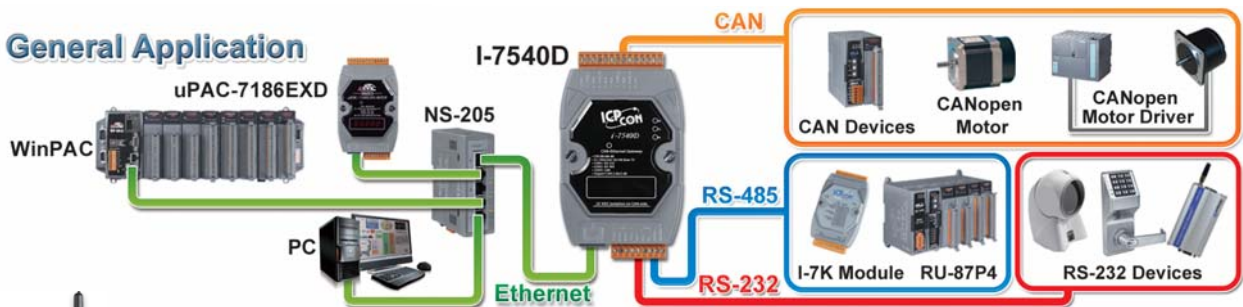

Wi-Fi to CAN Converter

I-7540D-WF



The I-7540D-WF supports the wireless transmission of CAN data between a CAN network and a WLAN network according to the 802.11b/g standard. It provides CAN to WLAN converter functionality together with wireless transparent transmission on the CAN network. The I-7540D-WF is highly suitable for connecting mobile (e.g., vehicles or machines) or stationary CAN networks and is often used in short ranges up to 100 m. Using an appropriately configured router, CAN data can be determined to pass or filter from the CAN networks to the Ethernet. The wireless connection that is established between two I-7540D-WF units can be used instead of a cable, and enables the connection of CAN networks that would otherwise be difficult to link such as rotational machineries.

- IEEE 802.11 b/g compliant
- Wireless data transmission via WLAN
- Connects CAN networks via a WLAN bridge
- Compatible with CAN specification 2.0 parts A and B
- Wireless transmission distance: up to 100 meters
- Two different operation modes: infrastructure and ad-hoc
- Supports WEP, WPA and WPA2 encryption for wireless LAN
- Point to point or point to multi-point connection via wireless LAN
- Communication efficiency (peak value): one-way is up to 700 fps (client->server, server->client), two-way 350 fps (client<=>server)

Ad hoc mode (AP is not necessary)



6.7 Uart to CAN Converters

The I-7530 series is the Uart to CAN converter that support CAN protocols 2.0A and 2.0B. The I-7530-FT is designed for the fault tolerance CAN bus (ISO 11898-3). The I-7530A-MR supports Modbus RTU command especially.

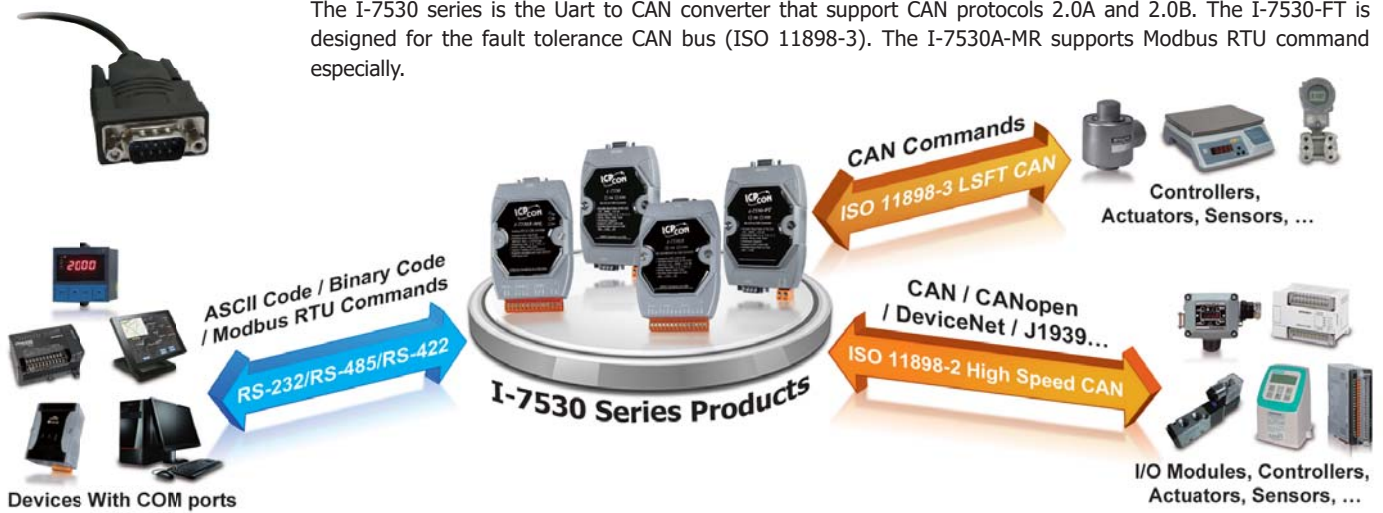

Models	I-7530-FT	I-7530	I-7530T	I-7530A	I-7530A-MR	tM-7530	tM-7530A
	RS-232 to Fault-Tolerance CAN Converter	RS-232 to CAN Converter		RS-232/422/485 to CAN Converter	Modbus RTU to CAN Converter	Tiny RS-232 to CAN Converter	RS-232/RS-485/RS-422 to CAN Converter
Pictures							
CAN Interface							
Transceiver	AMIS 41682	NXP 82C250	TJA1042	NXP 82C250		NXP TJA1042	
Connector	9-pin male D-sub					3 pins spring type terminal block	7-pin terminal block
Baud Rate	10 k, 20 k, 50 k, 125 k bps	10 k, 20 k, 50 k, 125 k, 250 k, 500 k, 800 k, 1 Mbps					
Protocol	ISO 11898-3 (low speed fault tolerance), CAN 2.0A and CAN 2.0B	ISO 11898-2, CAN 2.0A and CAN 2.0B					
Receiver Buffer	1000 data frames					256 data frames	
Isolation	–	3000 VDC for DC-to-DC				1000 VDC for DC-to-DC	
UART Interface							
Type	RS-232			RS-232/422/485		RS-232	RS-232/422/485
Protocol	–				Modbus RTU slave	–	
Connector	9-pin female D-sub			14-pin terminal block		9-pin female D-sub	10-pin terminal block
Baud Rate (bps)	110, 150, 300, 600, 1200, 2400, 4800, 9600, 19200, 38400, 57600, 115200			300, 600, 1200, 2400, 4800, 9600, 19200, 38400, 57600, 115200, 230400			
Receiver Buffer	900 data frames					256 bytes	
System							
Power Consumption	1 W						
Power Input	+10 VDC ~ +30 VDC						
Dimensions (W × L × H)	72 × 118 × 33 (mm)					52 × 98 × 27 (mm)	52 × 93 × 27 (mm)
Operating Temperature	-25°C ~ +75°C						
Storage Temperature	-30°C ~ +80°C						

6.8 CANopen Gateways

Model Name	Description	
CANopen Gateway	I-7232D	CANopen Slave to Modbus RTU Master Gateway
	GW-7433D	Modbus TCP/RTU Slave to CANopen Master Gateway
	GW-7553-CPM	PROFIBUS DP Slave to CANopen Master Gateway

CANopen Slave to Modbus RTU Master Gateway

I-7232D



The I-7232D is a CANopen slave to Modbus RTU master gateway, and allows a CANopen master to have ability to access the Modbus slave devices. In the CANopen network, the I-7232D is a NMT slave, SDO server, PDO producer, and PDO consumer. From the view of the Modbus network, it is a Modbus RTU master which polls all the predefined data of the Modbus RTU slaves, and bypass the CANopen control commands to the Modbus slaves. The I-7232D follows the CANopen specification CiA-301 v4.02 and CiA-401 v2.1, and supplies many features of CANopen protocols, such as dynamic PDO, EMCY object, error output value, SYNC cyclic and acyclic. An EDS file is also provided by the utility tool. Users can easily apply the I-7232D in the standard CANopen master with the EDS file.

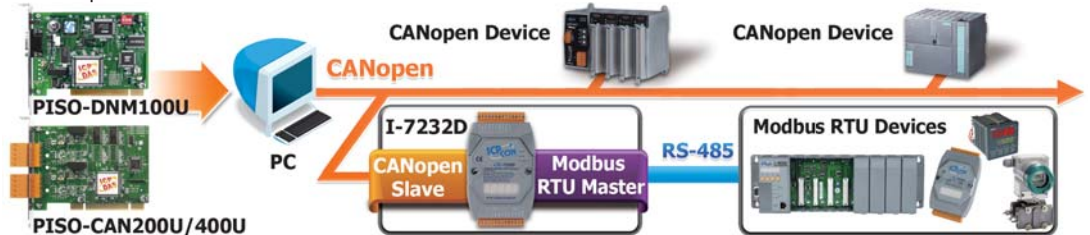

Modbus TCP/RTU Slave to CANopen Master Gateway

GW-7433D



The GW-7433D is communication transformation mechanisms between the Modbus protocol and the CANopen protocol. This module is able to collect the information of the CANopen slaves periodically, and returns these data to the Modbus TCP client or Modbus RTU master while receiving the Modbus commands. When the Modbus TCP client or Modbus RTU master needs to output data to the CANopen slaves, the GW-7433D transfers the received Modbus commands to the CANopen messages to handle the CANopen slaves. Both of the Modbus TCP server and the Modbus RTU slave functions can work on the GW-7433D simultaneously. The GW-7433D also offers the Modbus registers for recording the life statuses of the CANopen slaves.

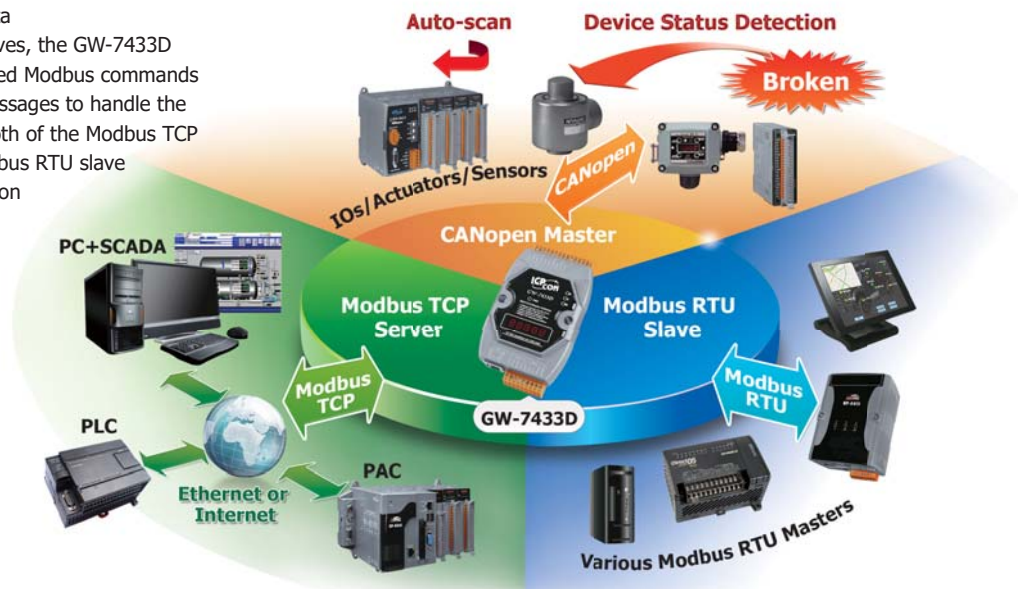

NEW

PROFIBUS DP Slave to CANopen Master Gateway

GW-7553-CPM

The GW-7553-CPM is designed for the slave device of PROFIBUS DP protocol. It allows PROFIBUS master to access CANopen slave devices. These CANopen slave device may be a sensor, actuators, ICPDAS CAN-2000 series modules and so forth. In addition, we also provide the utility software for users to configure the GW-7553-CPM.



6.9 DeviceNet Gateways

Model Name	Description	
DeviceNet Gateway	I-7242D	DeviceNet Slave to Modbus RTU Master Gateway
	GW-7243D	DeviceNet Slave to Modbus TCP/RTU/ASCII Master Gateway
	GW-7434D	Modbus TCP/RTU Slave to DeviceNet Master Gateway

DeviceNet Slave to Modbus RTU Master Gateway

I-7242D



The I-7242D allows a master located on a DeviceNet network to enter into a dialogue with the slaves on a Modbus RTU network. It's a "Group 2 Only Slave" device in the DeviceNet network, and supports "Predefined Master/Slave Connection Set". From the view of the Modbus network, it is a Modbus RTU master which polling all the predefined data of the Modbus RTU slaves, and bypass the DeviceNet control commands to the Modbus slaves. This device is widely used in the application of building automation, remote data acquisition, environment control and monitoring, laboratory equipment & research, factory automation, etc. The I-7242D also has the utility tool which is used to configure the I-7242D's parameters and build the EDS file. Through the EDS file, it is easy to apply the Modbus RTU devices in DeviceNet applications.

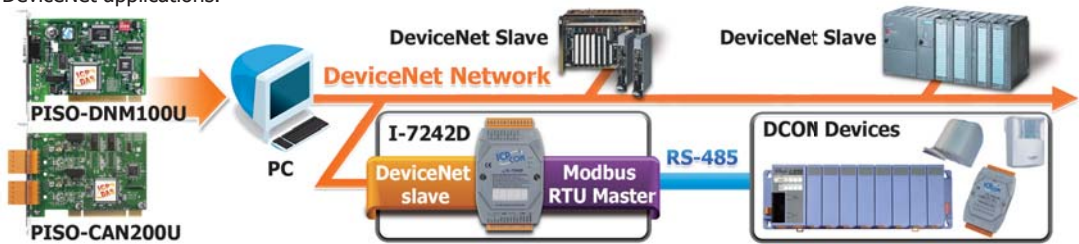

DeviceNet Slave to Modbus TCP/RTU/ASCII Master Gateway

GW-7243D



The GW-7243D offers the DeviceNet slave and Modbus master functions, and enables the DeviceNet master to access the Modbus slave devices. In the DeviceNet network, the module acts as a Group 2 Only Server device, and waits to build the connection with the DeviceNet master. In the Modbus network, the GW-7243D is a master device, and cyclically sends the commands to access the Modbus slave devices. Both the Modbus TCP client and Modbus RTU/ASCII master interfaces of the GW-7243D can work simultaneously. This feature means that users are able to integrate different kinds of Modbus slave devices together into the DeviceNet network no matter these devices provide Ethernet, RS-232 or RS-485 communication interfaces. In order to simplify the use of the GW-7243D, the GW-7243D Utility tool for configuration and EDS file production is given to build the applications easily and quickly.

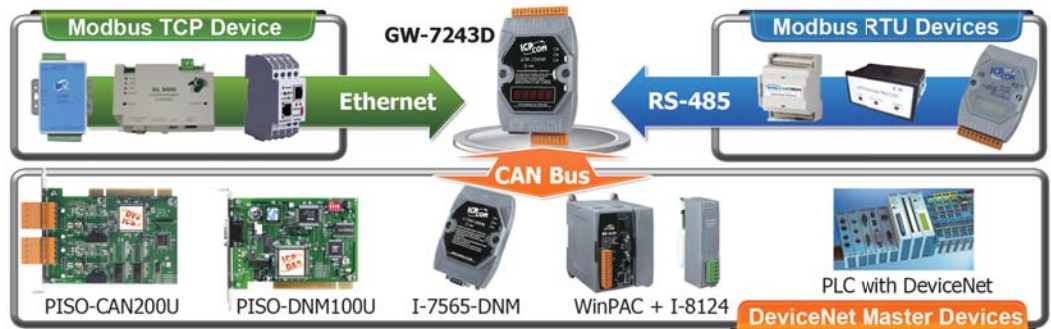

Modbus TCP/RTU Slave to DeviceNet Master Gateway

GW-7434D



The GW-7434D is a communication protocol transformation between the DeviceNet protocol and the Modbus TCP protocol. This module solves the problem to connect an existing DeviceNet network to the Ethernet-based PLC, HMI or SCADA for setting up a control or monitoring system. Different to the GW-7243D, the GW-7434D offers the Predefined Master connection Set function and Group 2 only Server function as a DeviceNet master, and enables accessing the DeviceNet slaves automatically and cyclically. If the PLC, HMI or SCADA would like to access the DeviceNet slaves and simultaneously communicate with the Modbus slaves or COM-based devices connected with the RS-232 or RS-485 ports of the GW-7434D, the GW-7434D can be the Modbus TCP server or VxComm server to exchange the data with those devices.



6.10 J1939 Gateways

J1939 is the vehicle bus standard used for communication and diagnostics among vehicle components, originally by the car and heavy duty truck industry in the United States. Because of the success of applying in vehicles, J1939 has become the accepted industry standard and the vehicle network technology of choice for off-highway machines in applications such as construction, material handling, and forestry machines. It is a higher-layer protocol based on Controller Area Network (CAN), which provides serial data communications between microprocessor systems (ECU) in any kind of heavy duty vehicles.

Model Name	Description	
J1939 Gateway	GW-7228	Modbus RTU Slave to J1939 Gateway
	GW-7238D	Modbus TCP/RTU Slave to J1939 Gateway

Modbus RTU Slave to J1939 Gateway

GW-7228



The GW-7228 enables the Modbus RTU master to exchange the data with the devices in the J1939 network. This module provides the Modbus slave functions on the RS-232, RS-422, and RS-485 ports so that the Modbus RTU master can easily control and monitor the J1939-based devices. If users use one of the communication ports for application, the other two ports can be used to monitor the Modbus communication situations between the Modbus master and the GW-7228. This feature is helpful for diagnosis while setting up an application system. For J1939 CAN networks, the GW-7228 supports PDU1, PDU2, broadcast and destination specific type of J1939 messages, and is widely applied in the Diesel power-train, in-vehicle networks for trucks and buses or where the Modbus RTU and J1939 protocols transformation is needed.

- Transmission and reception of all types of J1939 messages, including PDU1, PDU2, broadcast and destination specific
- Support Modbus RTU slave protocol with function codes 03, 04, 06 and 16
- Support BAM of Connection Management message
- Provide PWR/J1939/MODBUS indication LED
- Support RS-232, RS-485 and RS-422 interfaces
- Built-in jumper to select 120 Ω terminal resistor



Modbus TCP/RTU Slave to J1939 Gateway

GW-7238D



Similar to the GW-7228, the GW-7238D is a J1939 to Modbus master gateway. The main difference is that the GW-7238D has an Ethernet port as the Modbus TCP server, and allows connecting with up to 5 Modbus TCP clients. The GW-7238D also offers an RS-232 and RS-485 ports which are the Modbus RTU slaves and enable the Modbus RTU master to exchange the data with the devices in the J1939 network. Both the Modbus TCP server and the Modbus RTU slave functions of the GW-7238D can work simultaneously. This feature means that users can apply the GW-7238D in their applications more flexibly and more economically. For J1939 CAN networks, the GW-7238D supports PDU1, PDU2, broadcast and destination specific type of J1939 messages, and is widely applied in the various J1939-based applications.

- Transmission and reception of all types of J1939 messages, including PDU1, PDU2, broadcast and destination specific
- Support Modbus TCP server/RTU slave protocol with function code 03, 04, 06 and 16
- Communication support both Modbus TCP/RTU to J1939 at the same time
- Support BAM of Connection Management message
- Provide PWR/J1939/MODBUS/ERR indication LEDs
- Support RS-232, RS-485 and Ethernet interfaces
- Built-in jumper to select 120 Ω terminal resistor

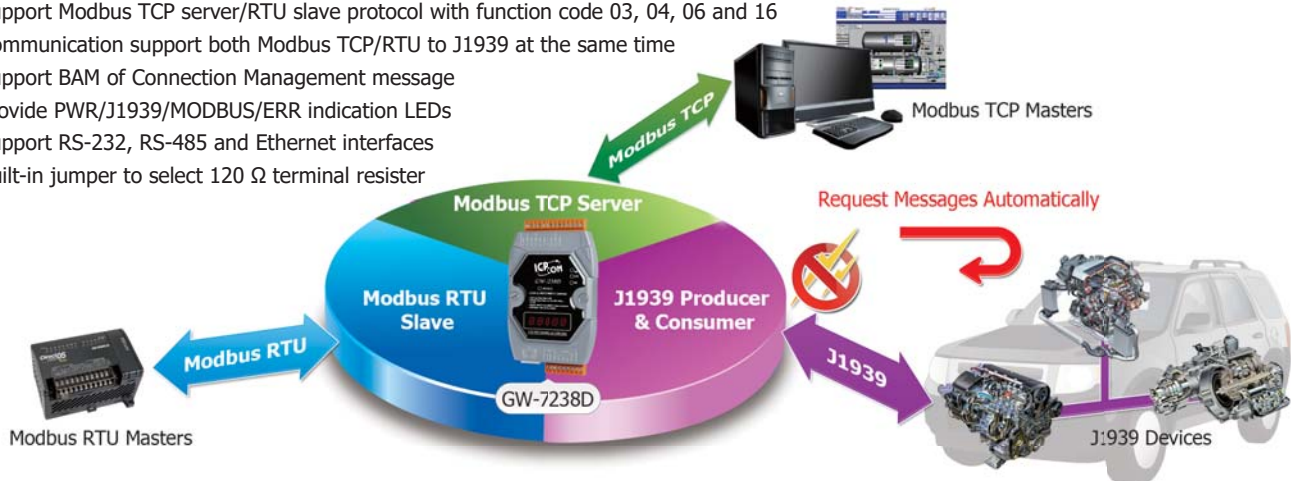

6.11 CAN Bus Data Logger

The CAN bus data logging device serves for logging of communication over the CAN data bus. Each received data packet is given a specific time mark, which shows the precise arrival time of data. The actual time mark is obtained from the internal real time clock (RTC), therefore it is independent of the global system time. Data logging on a common SD card allows further analysis and system monitoring on a PC. The CAN-Logger100/200 device by ICP DAS is the result of extensive CAN bus testing and CAN bus programming and is suited for all type of CAN bus application.



Models	CAN-Logger100	CAN-Logger200
Pictures	NEW	NEW
CAN Interface		
Transceiver	NXP TJA1042	
Channel Number	1	2
Connector	5-Pin male M12 × 1 (Pin 1: F.G., Pin 2: +Vs, Pin 3: GND, Pin 4: CAN_H Pin 5: CAN_L)	5-Pin male M12 × 2 (Pin 1: F.G., Pin 2: +Vs, Pin 3: GND, Pin 4: CAN_H Pin 5: CAN_L)
Transmission Speed (bps)	10 k, 20 k, 50 k, 100 k, 125 k, 250 k, 500 k, 800 k, 1 M and user-defined baud rate	
Terminator Resistor	DIP switch for the 120 Ω terminator resistor	
Isolation	3000 VDC for DC-to-DC, 2500 Vrms for photocoupler	
Specification	ISO-11898-2, CAN 2.0A and CAN 2.0B	
CAN Filter	Utility tool	
USB Interface		
Connector	USB Type B × 1	
Compatibility	USB 2.0 High Speed	
Max. Data flow	Transmit: 4000 fps ; Receive: 1000 fps	
Software Driver	Windows 2K/XP/7/8	
Data Logger Capability		
Storage Media	SDHC type flash – support 4 to 32 GB	
Recording Format	Binary	
Time Stamp Resolution	10 us	
Configuration	Utility tool	
Trigger	Log continuously	
Data Logger	Maximum message rate, receive: 15000 msgs/s	
LED		
Round LED	Power, MS, SD, CAN1, CAN2, CAN_ST LEDs	Power, MS, SD, CAN_Rx, CAN_Tx, CAN_ST LEDs
Power		
Power Supply	USB power or CAN bus power (Unregulated +10 ~ +30 VDC) delivery	
Protection	Power reverse polarity protection, Over-voltage brown-out protection	
Power Consumption	0.1 @ 24 VDC	
Mechanical		
Installation	DIN-Rail	
Casing	Metal	
Dimensions (W × L × H)	102 mm × 102 mm × 44 mm	
Environment		
Operating Temperature	-25°C ~ +75°C	
Storage Temperature	-30°C ~ +80°C	
Relative Humidity	10 ~ 90% RH, Non-condensing	

NEW

USB to 1-port CAN bus data logger device

CAN-Logger100



The CAN-Logger100 is a high-performance intelligent CAN bus data logger device with one CAN port that can help to make data collection and to process on a CAN bus network easier and quicker. The powerful CPU of the CAN-Logger100 provides the accurately time-stamp for each CAN message and supports storage media like MMC, SD or SDHC type flash for saving these CAN messages that is useful to analysis and diagnostic the CAN network. In order to enhance the portability of the CAN-Logger100, this module is powered by the USB interface or a M12 connector of CAN bus interface. The CAN-Logger100 uses the standard USB driver of the Windows system. Operating systems supported include Windows 2K/XP/7/8.

- Provides one CAN port
- Power by the USB port or CAN port
- 3 kV galvanic isolation for the CAN port
- Full compatible with the ISO 11898-2 standard
- 2500 Vrms photocoupler isolation on the CAN side
- Supports CAN bus acceptance filter configuration
- Compatible with CAN specification 2.0 parts A and B
- Programmable CAN bus baud rate from 10 kbps ~ 1 Mbps
- Built-in jumper for the 120 Ω terminal resistor of the CAN side
- Supports 4 to 32 GB SDHC type flash for saving CAN messages
- CAN messages are time-stamped with 10 microseconds resolution
- Provides a configuration utility that can be used to transmit/ receive CAN messages

NEW

USB to 2-port CAN bus data logger device

CAN-Logger200



The CAN-Logger200 is a high-performance intelligent CAN bus data logger device with two CAN port that can help to make data collection and to process on a CAN bus network easier and quicker. The powerful CPU of the CAN-Logger200 provides the accurately time-stamp for each CAN message and supports storage media like MMC, SD or SDHC type flash for saving these CAN messages that is useful to analysis and diagnostic the CAN network. In order to enhance the portability of the CAN-Logger200, this module is powered by the USB interface or M12 connectors of CAN bus interface. The CAN-Logger200 uses the standard USB driver of the Windows system. Operating systems supported include Windows 2K/XP/7/8.

- Provides two CAN port
- Power by the USB port or CAN port
- 3 kV galvanic isolation for the CAN port
- Full compatible with the ISO 11898-2 standard
- Supports CAN bus acceptance filter configuration
- 2500 Vrms photocoupler isolation on the CAN side
- Compatible with CAN specification 2.0 parts A and B
- Programmable CAN bus baud rate from 10 kbps ~ 1 Mbps
- Built-in jumper for the 120 Ω terminal resistor of the CAN side
- Supports 4 to 32 GB SDHC type flash for saving CAN messages
- CAN messages are time-stamped with 10 microseconds resolution
- Provides a configuration utility that can be used to transmit/ receive CAN messages



6.12 PC-based CAN Bus Boards

To access the CAN sensors, actuators, and I/O modules we provide communication boards for PC-based solution.

Communication Boards:

The following CAN bus communication boards are designed for different interface and different CAN port number. The common features are:

1. Compatible with CAN specification 2.0 parts A and B
2. Fully compatible with ISO 11898-2 standard
3. Supports baud rate from 10 kbps to 1 Mbps
4. 2 kV galvanic isolated
5. Direct memory mapping to the CAN controller

Software Support:

► For Windows:

- ✓ LabVIEW CAN Driver
- ✓ DASYLab CAN Driver
- ✓ RTX CAN Driver
- ✓ PISOCNX Active Object
- ✓ NAPOPC.CAN DA Server
- ✓ InduSoft Driver
- ✓ Power Meter Driver







► For Linux:

- ✓ SocketCAN Device Driver

PC-based CAN Communication Boards

Model Name	PEX-CAN200i	PISO-CAN100U	PISO-CAN200U	PISO-CAN400U	PISO-CAN800U
Pictures					
CAN Channel	2	1	2	4	8
Bus Interface	X1 PCI Express	Universal PCI			
On-board CPU	-				
Baud Rate	Programmable transfer rate up to 1 Mbps				
Terminator Resistor	Jumper for 120 Ω terminator resistor				
Galvanic Isolation	2 kV				
PC APIs	API for VB, VC, BCB, VB.Net, C#.Net				
RTX Driver	Yes				-
LabVIEW Driver	Yes				-
InduSoft Driver	Yes				-
OPC Server	Yes				-
OCX	Yes				-
SocketCAN Driver	Yes				-
Device Driver	Windows XP/7/8.1/10, Linux				Windows XP/7

Model Name	PCM-CAN100	PCM-CAN200	PCM-CAN200P
Pictures			
CAN Channel	1, and the other for bypass	2	
Bus Interface	PCI-104		PC/104-Plus
On-board CPU	-		
Baud Rate	Programmable transfer rate up to 1 Mbps		
Terminator Resistor	Jumper for 120 Ω terminator resistor		
Galvanic Isolation	2 kV		
PC APIs	API for VB, VC, BCB, VB.Net, C#.Net		
RTX Driver	Yes		
LabVIEW Driver	Yes		
InduSoft Driver	Yes		
OPC Server	Yes		
OCX	Yes		
SocketCAN Driver	Yes		
Device Driver	Windows XP/7/8.1/10, Linux		

Model Name	PISO-CM100U	PISO-CM200U	PCM-CM100	PISO-DNM100U	PISO-DNS100U	PISO-CPM100U	PCM-CPM100
Pictures							
CAN Channel	1	2					1
Bus Interface	Universal PCI		PCI-104	Universal PCI			PCI-104
On-board CPU	Yes						
On-board CPU OS	MiniOS7	-		MiniOS7			
On-board CPU APIs	C/C++	-	C/C++	-			
Default Firmware	CAN 2.0A/2.0B			DeviceNet Master	DeviceNet Slave	CANopen Master	
EDS File Support	-				Yes		
Baud Rate	Programmable transfer rate up to 1 Mbps			125 k, 250 k, and 500 kbps		10 k, 20 k, 50 k, 125 k, 250 k, 500 k, 800 k, 1 Mbps	
Terminator Resistor	Jumper for 120 Ω terminator resistor						
Galvanic Isolation	2 kV	3 kV		2 kV			
PC APIs	API for VB, VC++, BCB, Delphi	API for VB.Net, C#.Net, VC++.Net	API for VB, VC++, BCB, Delphi	API for VB, VC++, VB.Net, C#.Net			
LabVIEW Driver		-		Yes		-	
InduSoft Driver	Yes	-		Yes	-		Yes
Power Meter Driver	Yes	-	Yes		-		Yes
Device Driver	Windows XP/7/8.1/10, Linux	Windows XP/7/8.1/10		Windows XP/7/8.1/10, Linux			

Connector Types: -T/-D

Each CAN bus board provide two type of connectors and, DB9 and Terminal Block.



PISO-xxxxx-D

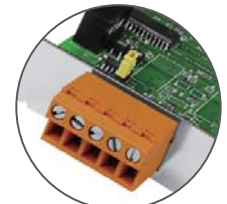

PISO-xxxxx-T

Accessory:

Optional Cable for PISO-CAN800U

CA-9-3705:

DB-37 Male (D-sub) to 4-Port DB-9 Male (D-sub) cable. 0.3 M (90°)



CA-9-3715D:

DB-37 Male (D-sub) to 4-Port DB-9 Male (D-sub) cable. 1.5 M (180°)



Optional CAN bus connector: CNT-CAN

CA-0910-C

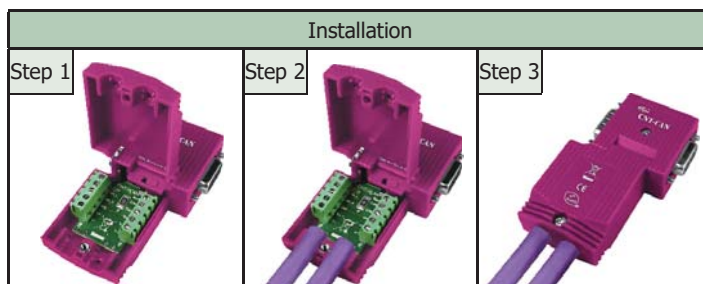

- D-Sub 9-pin Connector
- Screwed Terminal connector

CAN bus boards

The PCI and PCI Express CAN bus boards use the new CAN controller Phillips SJA1000T and transceiver TJA1042, which provide bus arbitration, error detection with auto correction and re-transmission function. It can be installed in a 5V or 3.3V PCI slot and supported truly "Plug & play".

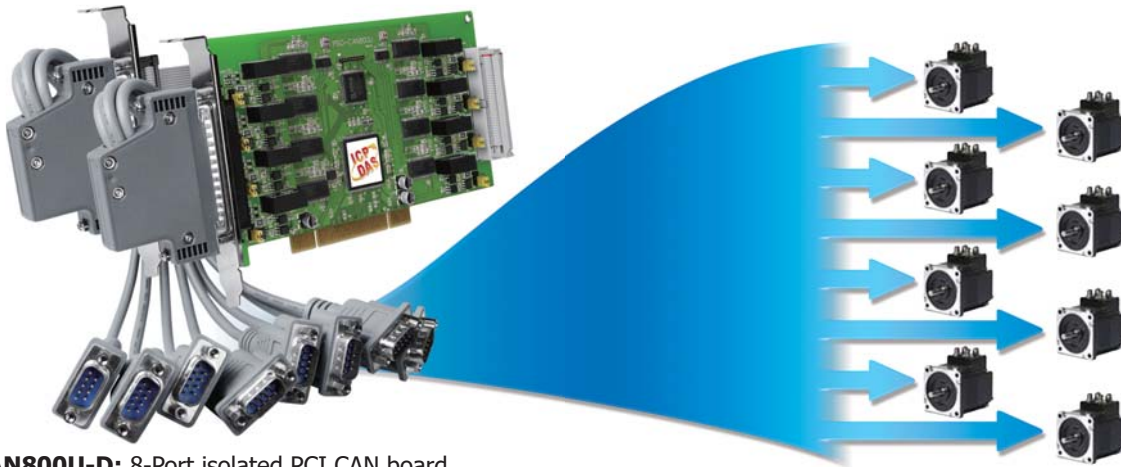

PISO-CAN800U-D: 8-Port isolated PCI CAN board

Common Features:

- Universal PCI card, supports both the 5 V and the 3.3 V PCI bus
- Compatible with CAN specification 2.0 parts A and B
- Fully compatible with the ISO 11898 -2 standard
- Support a range of baud rates from 10 kbps ~ 1 Mbps
- VB, VC++, Delphi, and Borland C++ builder demos are provided
- Built-in jumper for the 120 Ω terminator resistor of the CAN bus
- 2500 Vrms photocoupler isolation on the CAN side
- Provide 1/2/4/8 independent CAN channels
- 2 kV galvanic isolation for each CAN port
- Direct memory mapping to the CAN controller
- Supports LabVIEW and DASyLab drivers

PISO-CM100U, PCM-CM100: CAN board with built-in programmable CPU

As a stand-alone CAN controller, the PISO-CM100U/PCM-CM100 represents a powerful and economic solution. It has an internal 16-bit 80186 compactable CPU for the complex protocol interpretations and implementations. Owing to the real-time DOS-like OS, MiniOS7, the PISO-CM100U/PCM-CM100 can cover most of all time-critical CAN-based applications, such as self-define CAN protocol, CANopen, DeviceNet, J1939, and so forth. Therefore, when users develop their projects, the PISO-CM100U/PCM-CM100 is helpful to handle the process of the CAN messages, and share the CPU loading of the PC or embedded system. Besides, the PISO-CM100U/PCM-CM100 allows users designing the firmware of the PISO-CM100U/PCM-CM100. Through the library and demos, it is easy to finish the user-defined firmware to satisfy the users' requirements.

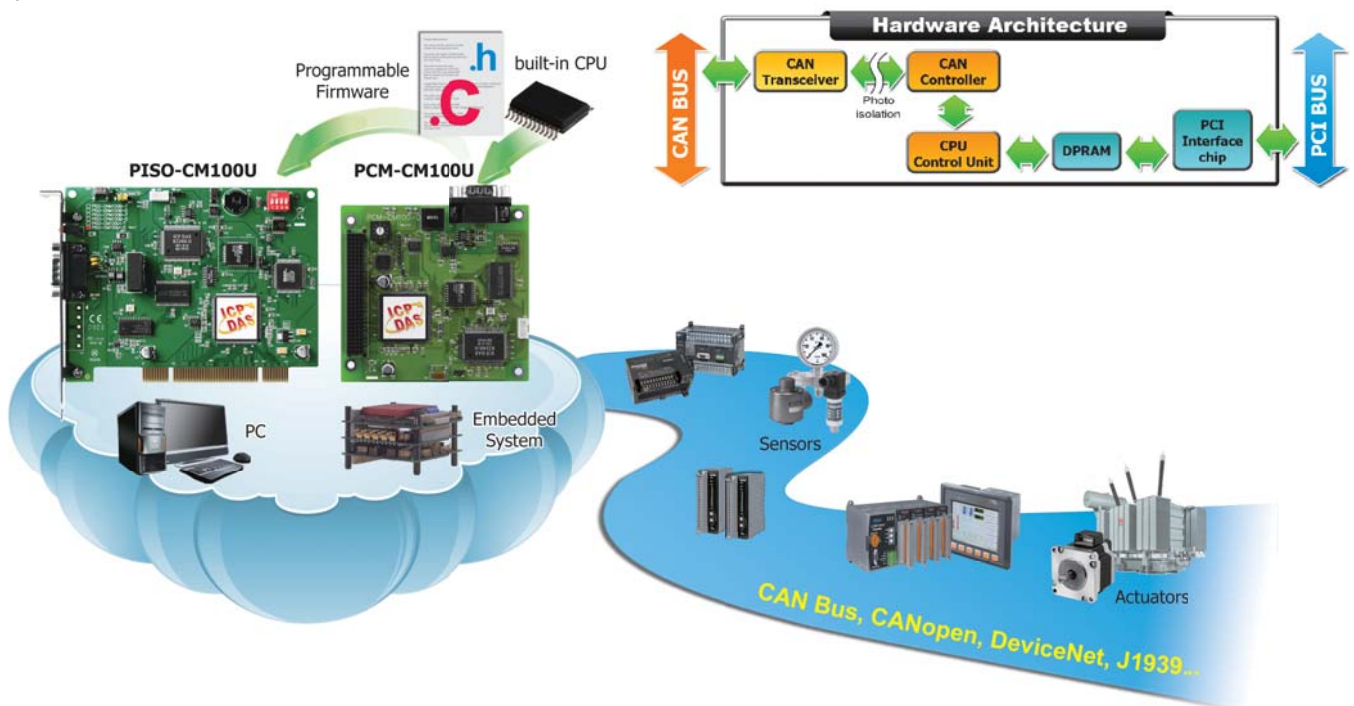

6.13 Palm-size Programmable CAN Controllers

The palm size PACs (Programmable Automation Controller) includes I-7188XBD-CAN, uPAC-7186EXD-CAN and uPAC-5001D-CAN2. With abundant and various peripherals and communication ports, the PAC can integrate different communication interface, like CAN bus, RS-232, RS-485, Ethernet and so on. In order to increase the modules openness and applications flexibility, the PAC provides MiniOS7, a DOS-like real-time single-task operation system for adapting to all kinds of needs. Users can develop application programs via C/C++ compiler.

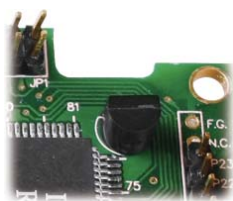

Unique 64-bit Hardware Serial Number



Built-in RTC - Real Time Clock

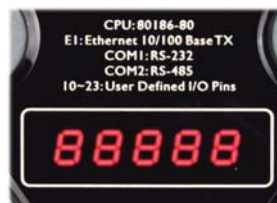

5-Digit 7-Segment LED Display



microSD expansion

Model Name	I-7188XBD-CAN	uPAC-7186EXD-CAN	uPAC-5001D-CAN2
Pictures			
System Software			
OS	MiniOS7 (DOS-like embedded operating system)		
Development Software			
Download Interface	RS-232 (COM1) or Ethernet		
Language	C language		
Compilers	TC++ 1.01, TC 2.01, BC++3.1 ~ 5.2x, MSC 6.0, MSVC++ (before version 1.5.2)		
CPU Module			
CPU	80188, 40 MHz or compatible	80186, 80 MHz or compatible	
SRAM	512 KB	512 KB	512 KB
Flash	512 KB	512 KB	512 KB
microSD Expansion	-	-	Up to 2 GB
EEPROM	2 KB	16 KB	
NVRAM	31 Bytes (battery backup, data valid up to 10 years)		
RTC (Real Time Clock)	Provide second, minute, hour, date, day of week, month, year		
64-bit Hardware Serial Number	Yes, for Software Copy Protection		
Watchdog Timers	Yes (0.8 second)		
Communication Ports			
Ethernet	-	10/100 Base-TX (Auto-negotiating, Auto MDI/MDI-X, LED indicators)	
COM 1	RS-232 (TxD, RxD, RTS, CTS, GND) or RS-485 (Data+, Data-), non-isolated	RS-232 (TxD, RxD, RTS, CTS, GND), non-isolated	
COM 2	RS-485 (Data+, Data-) with internal self-tuner ASIC; non-isolated		
CAN	1 channel	1 channel	2 channels
LED Indicator			
7-Segment LED	Yes		
Programmable LED Indicators	4	5	
Mechanical			
Dimension (W × L × H)	72 mm × 122 mm × 33 mm		91 mm × 123 mm × 52 mm
Installation	DIN-Rail Mounting		
Environmental			
Operating Temperature	-25 ~ +75°C		
Storage Temperature	-30 ~ +80°C		
Ambient Relative Humidity	10 ~ 90% RH (non-condensing)		
Power			
Input Range	10 ~ 30 VDC		12 ~ 48 VDC
Redundant Power Inputs	-		Yes
Power Consumption	3 W		

6.14 PAC-based CAN Modules

These CAN bus communication modules are the solutions to the various CAN application requirements in PAC family with rich CAN bus protocols. The I-8123W, I-87123W, I-8124W, and I-87124W separately support CANopen and DeviceNet master protocols. Users can apply them in PAC to connect to CANopen and DeviceNet devices to reach various CANopen/DeviceNet systems easily.

For the especial CAN bus applications, the I-8120W and I-87120W are designed for users to apply in PAC series. The default firmware of I-8120W and I-87120W provides the transmission and reception of CAN bus messages in PAC. In addition, users can design the specific firmware in these modules to reduce the loading of the PAC in C language.

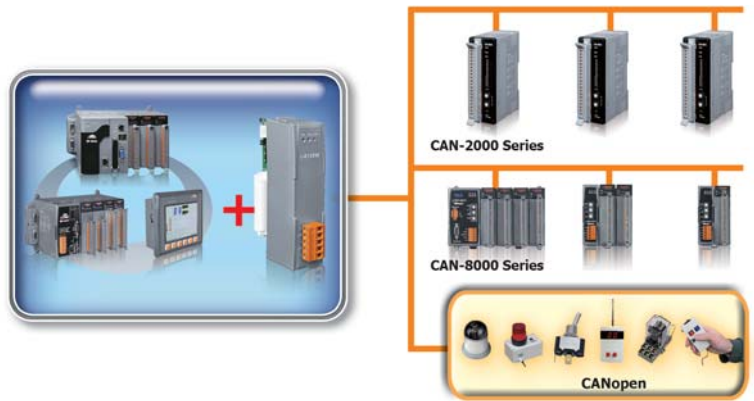







CAN/CANopen/DeviceNet Communication Module (Parallel/Serial Bus)						
Model Name	I-8120W	I-87120	I-8123W	I-87123	I-8124W	I-87124
Pictures						
Communication						
Interface	ISO 11898-2 CAN					
Port	1					
Terminator	120 Ω Selected By Jumper					
Max. Speed (K bps)	1000		1000		500	
Controller Chip	SJA1000T					
Transceiver Chip	82C250					
Protocol	CAN 2.0 A/2.0 B		CANopen CiA 301 ver 4.02, CiA 401 ver 2.1		DeviceNet Volume I ver 2.0, Volume II ver 2.0	
System						
Hot Swap	-	Yes	-	Yes	-	Yes
Data Communication	Parallel Interface	Serial Interface	Parallel Interface	Serial Interface	Parallel Interface	Serial Interface
User-defined Firmware	Yes		-		-	
Isolation	2500 Vrms					
Power Consumption	2 W					
Connector	5-pin Terminal Block					
Optional Accessories	CA-0904 Cable					
 CA-0904						
Model Name	I-8120W	I-87120	I-8123W	I-87123	I-8124W	I-87124
PAC Driver Support						
I-8000, iP-8000	-	BC, TC	-	BC, TC	-	BC, TC
VP-2111						
WP-8000	eVc++ 4.0, VB.Net 2005, C#.Net 2005					
VP-2000						
XP-8000-CE6, XP-8000-Atom-CE6	VB.Net 2005, C#.Net 2005, VC 2005					
XP-8000, XP-8000-Atom	VB.Net 2005, C#.Net 2005, VC 6					
LP-8000	-	GCC	-	GCC	-	GCC

6.15 PROFIBUS Converters & Gateways

The PROFIBUS repeater is used to solve the issues of the PROFIBUS segment, transmission distance and disturbance when setting up a PROFIBUS network. If it is necessary to integrate the different communication interface, the PROFIBUS converter is helpful. The application architectures as following figures provide the examples to show when and how to apply these products.

Model Name	Description	
Converters	I-7550	PROFIBUS to RS-232/422/485 Converter
	I-7550E	PROFIBUS to Ethernet Converter
	PROFI-2510	Isolated PROFIBUS Repeater
	PROFI-2541	PROFIBUS to Fiber (ST connector) Converter
	PROFI-2541-SC	PROFIBUS to Fiber (SC connector) Converter
	PROFI-2542-SC	PROFIBUS to Single mode Fiber (SC connector) Converter
Gateway	GW-7552	PROFIBUS DP Slave to Modbus RTU Master Gateway
	GW-7553	PROFIBUS DP Slave to Modbus TCP/RTU Master Gateway
	GW-7553-CPM	PROFIBUS DP Slave to CANopen Master Gateway
	GW-7557	PROFIBUS DP Slave to HART Master Gateway

Model Name	I-7550	I-7550-E	PROFI-2510	PROFI-2541	PROFI-2541-SC	PROFI-2542-SC
Pictures	PROFIBUS to RS-232/422/485 Converter 	PROFIBUS to Ethernet Converter 	Isolated PROFIBUS Repeater 	PROFIBUS to Fiber Converter   		
PROFIBUS Channel	1		2	1		
PROFIBUS Baud Rate (bps)	9.6 k ~ 12 M			9.6 k ~ 3 M		9.6 k ~ 12 M
PROFIBUS Protocol	DP-V0 Slave		DP-V0/DP-V1/DP-V2			
PROFIBUS Address	0~126 set by DIP switch		-			
PROFIBUS Transmission Distance (m)	Depend on baud rate					
COM 1	RS-232/RS-485/RS-422	RS-232	-			
COM 1 Baud Rate (bps)	1.2 K ~ 115.2 K	115.2 K	-			
Fiber Channel				1		
Fiber Connector				ST (Multi-mode)	SC (Multi-mode)	SC (Single-mode)
Fiber Transmission Distance (m)				1.4 km Max. (in 62.5/125 μm fiber cable)		10 km (in 9/125 μm fiber cable)
Ethernet Speed	-	10/100M	-			
Ethernet Protocol	-	TCP/UDP Server/Client	-			

PROFIBUS DP Slave to Modbus TCP/RTU Gateway

GW-7552



The GW-7552 gateway is a PROFIBUS DP slave. It allows the PROFIBUS master to access the Modbus RTU devices. In the Modbus network, the GW-7552 can be a master to access the Modbus slaves, or be a slave to provide the data from the PROFIBUS master. The flexible design lets the GW-7552 widely applying in the many applications.

- Protocol PROFIBUS DP-V0 Slave
- Detect transmission rate (9.6 to 12000 kbps) on PROFIBUS automatically
- 132 bytes Max. input data length
- 131 bytes Max. output data length
- Support Modbus master mode and slave mode
- PROFIBUS address 0 ~ 126 set by DIP switch
- Support several kinds of baud for COM1 from 2.4 ~ 115.2 kbps

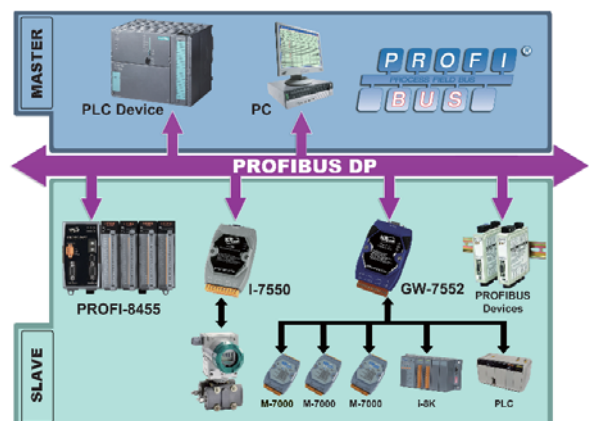

PROFIBUS DP Slave to Modbus TCP/RTU Gateway

GW-7553



The GW-7553 is used for data-exchange between the Modbus TCP/RTU network and the PROFIBUS network. It provides not only the Modbus TCP client and server functions, but the Modbus RTU master and slave functions. Therefore, the GW-7553 can satisfy most of the applications of the data transfer between Modbus and PROFIBUS.

- Protocol PROFIBUS DP-V0 & DP-V1 slave
- Support one 10/100 Base-TX Ethernet port
- Support one RS-232 port
- 240 bytes Max. input data length
- 240 bytes Max. output data length
- Support Modbus TCP/RTU/ASCII protocol
- PROFIBUS address 0 ~ 126 set by DIP switch
- Detect Transmission rate (9.6 to 12000 kbps) on PROFIBUS automatically

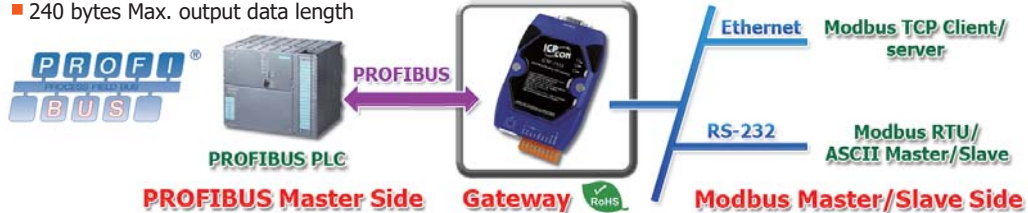

NEW

PROFIBUS DP Slave to CANopen Master Gateway

GW-7553-CPM



The GW-7553-CPM is designed for the slave device of PROFIBUS DP protocol. It allows PROFIBUS master to access CANopen slave devices. These CANopen slave device may be a sensor, actuators, ICPDAS CAN-2000 series modules and so forth. In addition, we also provide the utility software for users to configure the GW-7553-CPM. By using this module, users can put their CANopen slave devices into PROFIBUS network very easily.

- Protocol: PROFIBUS DP-V0 slave
- Support Heartbeat function
- Support Node Guarding
- 240 bytes Max. input data length
- 240 bytes Max. output data length
- Follow the CiA CANopen Standard DS-301 v4.02
- Support 110 CANopen SDO/PDO commands
- PROFIBUS address 0 ~ 126 set by DIP switch
- Detect Transmission rate (9.6 to 12000 kbps) on PROFIBUS automatically



PROFIBUS DP Slave to HART Master Gateway

GW-7557



The GW-7557 is designed for the slave device of PROFIBUS DP protocol. It allows the PROFIBUS master to access the HART slave devices. These HART devices may be a transmitter, an actuator, a current output device and so forth. Owing to the GW-7557, you can communicate the HART slave devices into PROFIBUS network very easily.

- PROFIBUS address 0 ~ 126 set by DIP switch
- Support HART mode: point-to-point/multi-drop
- Protocol: PROFIBUS DP-V0 slave
- Support HART Short/Long frame
- 240 bytes Max. input data length
- 240 bytes Max. output data length
- Support 4 HART channels, each for Max. 15 HART modules
- Detect transmission rate (9.6 to 12000 kbps) on PROFIBUS automatically

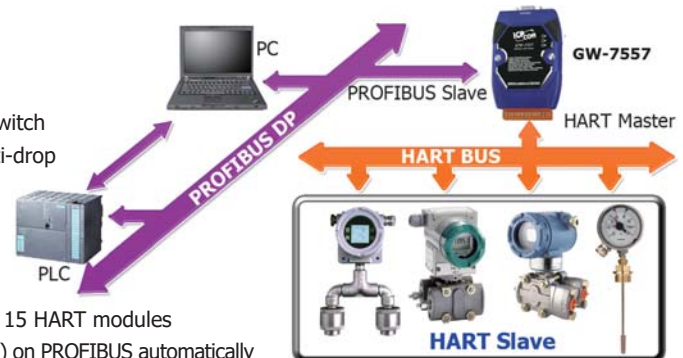

Application:



Optional PROFIBUS connector: CNT-PROFI



Installation

6.16 PROFINET Converters & Gateways

Model Name	Description	
PROFINET Converter	I-7580	PROFINET to RS-232/422/485 Converter
PROFINET Gateway	GW-7662	PROFINET to Modbus RTU/ASCII Gateway
	GW-7663	PROFINET to Modbus TCP Gateway

NEW

PROFINET to RS-232/422/485 Converter

I-7580



The I-7580 is specially designed for PROFINET IO device. It offers RS-232, RS-422, and RS-485 three kinds of communication way. With the Hybrid COM 1 design, users can readily choose one type of com port to use. Through the GSDML file, it is easy to communicate with any standard PROFINET IO controller.

- Protocol: PROFINET IO Device
- 512 bytes Max. input data length
- 384 bytes Max. output data length
- Cyclic Time: 1 ms (min)
- Generic GSDML File Provided (Version 2.25)
- PROFINET Conformance Class B and RT Class 1
- 4 kV Contact ESD protection for any terminal



NEW

PROFINET to Modbus RTU Master Gateway

GW-7662



The GW-7662 gateway is a PROFINET IO device that allows the PROFINET controller to access the Modbus RTU devices. In the Modbus network, the GW-7662 can be a Modbus master to access the Modbus slaves, can be a Modbus slave provide the data from the PROFINET controller. The flexible design lets the GW-7662 widely applying in the many applications.

- Support several kinds of baud for COM1 from 2.4 ~ 115.2 kbps
- Max length of in/output data is 512/512 Bytes
- PROFINET Conformance Class B and RT Class 1
- Generic GSDML File Provided (Version 2.25)
- Protocol: PROFINET IO Device
- Support Modbus RTU/ASCII protocol
- Support Modbus Master and Slave mode
- Cyclic Time: 1 ms (min)

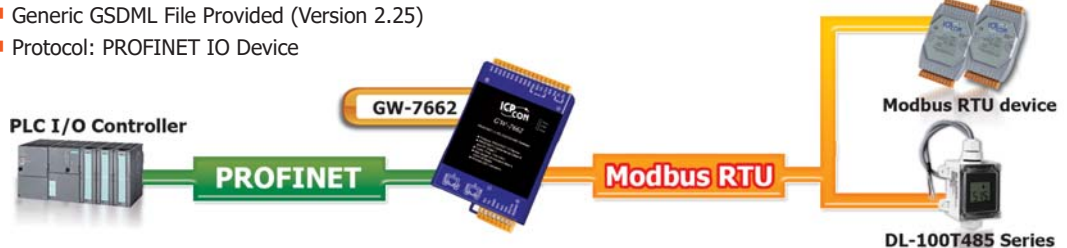

NEW

PROFINET to Modbus TCP Master Gateway

GW-7663



The GW-7663 is used for data-exchange between the Modbus TCP network and the PROFINET network. It provides the Modbus TCP client and server functions. Therefore, the GW-7663 can satisfy most of the applications of the data transfer between Modbus and PROFINET.

- Max length of in/output data is 512/512 Bytes
- PROFINET Conformance Class B and RT Class 1
- Generic GSDML File Provided (Version 2.25)
- Protocol: PROFINET IO Device
- Cyclic Time: 1 ms (min)
- Support Modbus TCP protocol
- Support Modbus Master and Slave mode

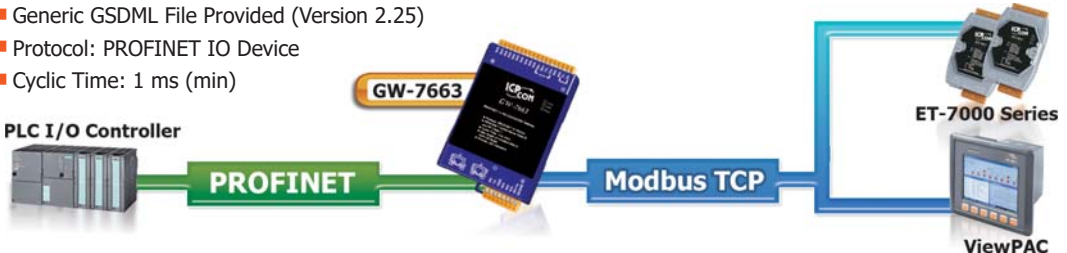

6.17 HART Converters, Gateways & Signal Filter

ICP DAS have deeply researched on the HART bus technology for many years. The total HART products have been developed by ICP DAS including HART converter, HART gateway and HART I/O modules. The HART converter can be used to access HART devices via COM, USB or Ethernet interface. The HART gateway can integrate HART communication to the different protocols like Modbus, PROFIBUS etc.

Model Name		Description
Converter	I-7547	Ethernet to HART Converter
	I-7567	USB to HART Converter
	I-7570	RS-232/422/485 to HART Converter
	HRT-227CS	HART to Single Mode Fiber Converter
	HRT-328-A4	HART-to-Analog Converter and Loop Monitor
Gateway	HRT-710	Modbus RTU/ASCII Slave to HART Master Gateway
	HRT-310	Modbus RTU/ASCII Slave to HART Master Gateway (Upright)
	HRT-711	Modbus TCP Slave to HART Master Gateway
	GW-7557	PROFIBUS DP Slave to HART Master Gateway
Signal Filter	HRT-370	HART Signal Filter with one AI and one HART channel

NEW

Ethernet to HART Converter

I-7547



- Support HART Burst mode
- Allow two HART masters
- Provide four HART channels

The I-7547 is an Ethernet to HART converter designed as the master device of HART protocol. It allows users to access the HART slave via Ethernet. These HART slave devices may be a transmitter, actuator, current output device and so forth. In addition, by using the HC_Tool utility, users can configure module and test HART communication easily and quickly.

- Selectable 250 Ω load resistor
- Support HART Short/Long frame
- Support point-to-point or multi-drop HART mode
- Support connecting up to 15 HART slave devices
- Support firmware update via Ethernet
- Support HART Pair-Connection (FW_v1.03)
- Support FDT (Field Device Tool) technology

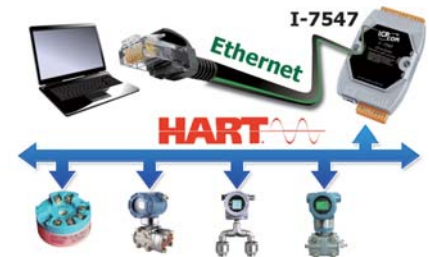

USB to HART Converter

I-7567



- Support HART Short/Long frame
- Support HART Burst mode
- Allow two HART masters
- Support the in point-to-point or multi-drop HART network mode

I-7567 is a USB to HART converter specially designed as the master device of HART protocol. Through it, users can easily access the HART network via USB port which is implemented as a virtual COM port on PCs or notebooks. Because the I-7567 is powered by the USB interface, the external power is not necessary. Moreover, the I-7567 provides the Utility tool which is helpful for diagnosing and configuring the HART network.

- Powered by USB (external power is not necessary)
- Support firmware update via USB
- Provide selectable 250 Ω load resistor
- Allow to connect with Max. 15 HART modules
- Compatible with USB 1.1 and 2.0 standards
- Support HART OPC Server provided by HART COMMUNICATION FOUNDATION (HCF)



RS-232/422/485 to HART Converter

I-7570



- Support HART Short/Long frame
- Support HART Burst mode
- Allow two HART masters
- Support the in point-to-point or multi-drop HART network mode

The I-7570 is a Serial to HART converter specially designed as the master device of HART protocol. By using I-7570, the HART devices, such transmitters, actuators, gauges, meters, and the current output devices, can be easily integrated into the HMI/PLC/PC devices via serial port which may be RS-232/RS-422/RS-485 interface. In order to diagnose and configure the HART network more easily, the I-7570 Utility tool with friendly configuration interface is given. It is helpful for diagnosing and configuring the HART network.

- Support firmware update via COM1
- Allow to connect with Max. 15 HART modules
- Provide selectable 250 Ω load resistor
- Isolated COM 1: 3-wire RS-232/RS-422/RS-485
- Support HART OPC Server provided by HART COMMUNICATION FOUNDATION (HCF)



HART to Single Mode Fiber Converter

HRT-227CS



The HRT-227CS is a HART to Fiber converter paired used to extend HART communication distance via single mode fiber optic transmission medium. In order to solve the problem between HART and fiber transmission medium, HRT-227CS is specially designed for converting the HART signal to fiber optic cables. Built-in a HART 250 Ω loop resistor adjustable by dip switch. Therefore, users can make data collection and processing of HART network easier and quicker by applying HRT-227CS. In addition, we also provide the free HC_Tool utility for module configuration easily.

- Support HART Burst mode
- Allow two HART masters
- Fiber broken line detection

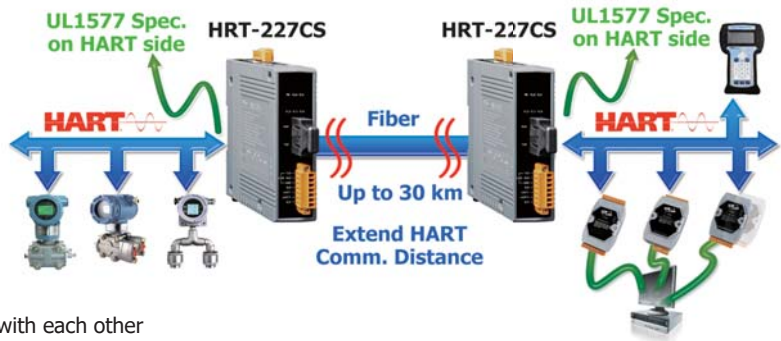

- Support HART Short/Long frame
- Support firmware update via COM port
- Support point-to-point or multi-drop HART mode
- Support connecting up to 15 HART slave devices
- Fiber Type: SC ; Single mode ; 100 Base-FX
- Fiber max. transmission distance up to 30 km
- Selectable 250Ω loop resistor
- The HART port with the same Group ID can communicate with each other

HART-to-Analog Converter and Loop Monitor

HRT-328-A4



The ICPDAS HRT-328-A4 HART Loop Converter enables the conversion of a digital multivariable HART signal into four independent 4 ~ 20 mA analog process variables. The HRT-328-A4 can apply in control or monitoring application to obtain up to four additional analog outputs without additional process penetrations.

The HRT-328-A4 allows up to four additional analog process variables from a multivariable transmitter or valve with no additional process penetrations. Besides, installed transparently across the 4~20 mA instrument loop, the HRT-328-A4 reads the HART digital process data that rides on the loop wires. The HRT-328-A4 converts the digital information for up to four isolated analog process signals that are readily accepted by in-place control system, such as DCS or PLC. The HRT-328-A4 not only

converts multivariable into analog process signal but also monitors the multivariable under/over limit intelligently. There are 4 built-in user programmable alarm output for monitoring. When a variable of transmitter under or over the user defined limit, the programmable alarm will activate automatically without DCS or PLC.

- Support HART Short/Long frame
- 4 Independent Analog Output Signals
- Built-in 2 Form A and 2 Form C relays
- Intelligent Activate Relay Alarm automatically
- Support Acquire Long Frame Address Automatically
- Working in Point-to-Point Mode
- Support HART Burst mode
- Allow two HART Masters
- Support Firmware Update

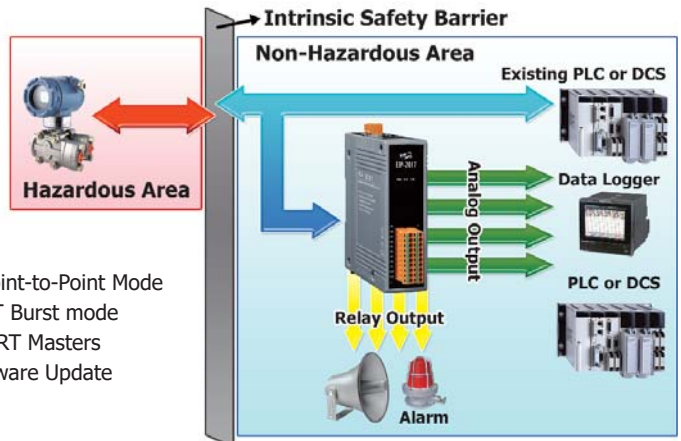

Modbus RTU/ASCII Slave to HART Master Gateway

HRT-710



HRT-310



The HRT-710/HRT-310 is a Modbus RTU/ASCII slave to HART master gateway. It provides an economic solution for Modbus master device to access the HART slave devices. In order to diagnose and configure the HART network more easily, the HG_Tool Utility with friendly configuration interface is given.

- Support HART Short/Long frame
- Isolated COM 1: RS-232/422/485
- Connecting up to 15 HART modules
- Support Modbus RTU and ASCII format
- Working in point-to-point or multi-drop HART mode
- Support firmware update via Com Port (FW_v1.2 and HW_v1.2)
- Support on-line replacement of HART devices (FW_v1.5)
- Support acquire Long Frame Address automatically (FW_v1.5)
- Support HART Burst mode
- Support Modbus Slave mode
- Allow two HART Masters

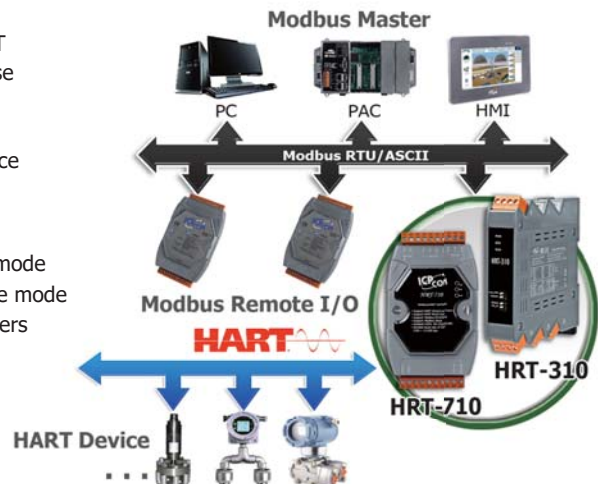

NEW

Modbus TCP Slave to HART Master Gateway

HRT-711



The HRT-711 is a new Modbus/TCP to HART Gateway. It allows the Modbus/TCP Master to access the HART Slave devices. These HART devices may be a transmitter, an actuator, a current output device and so forth. By using the HRT-711, users can integrate their HART devices into Modbus network easily. Therefore, HRT-711 can be a powerful gateway to exchange the data between Modbus and HART network. Moreover, the HRT-711 can be applied in the various hard environments because its high isolation protection designs. This design makes users to apply widely application for the remote data acquisition, control, process automation, and factory automation, etc.

- Support HART Short/Long frame
- Support HART Burst mode
- Allow two HART Masters
- Working in point-to-point or multi-drop HART mode
- Connecting up to 15 HART modules
- Support Modbus TCP
- Support Modbus Slave mode
- Support firmware update via Com Port
- Support on-line replacement of HART devices
- Support acquire Long Frame Address automatically

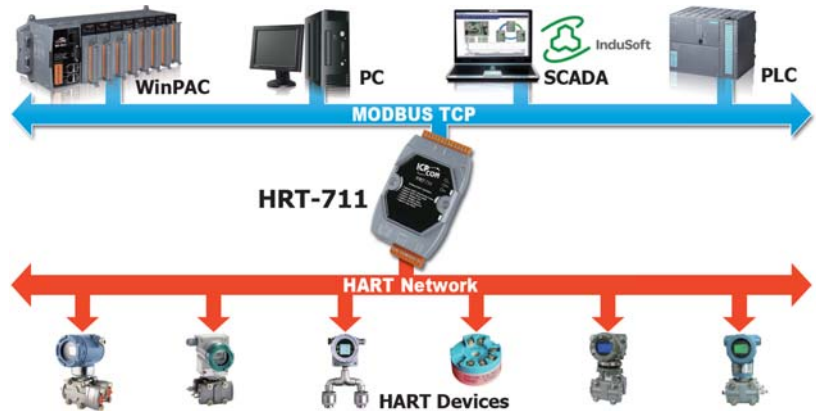

PROFIBUS DP Slave to HART Master Gateway

GW-7557



The GW-7557 is designed for the slave device of PROFIBUS DP protocol. It allows the PROFIBUS master to access the HART slave devices. These HART devices may be a transmitter, an actuator, a current output device and so forth. Owing to the GW-7557, you can put the HART slave devices into PROFIBUS network very easily.

- Support PROFIBUS DP-V0 slave
 - Support 4 HART Channels
 - Support HART Short/Long frame
 - Support HART Burst mode
 - Allow two HART Masters
- Protocol & Hierarchy: DP-V0 Slave
 - Max I/O Data Length: 240/240 Bytes
 - Working in point-to-point or multi-drop HART mode
 - Connecting up to 15 HART modules
 - Network Isolation Protection: High Speed iCoupler
 - Detect transmission rate (9.6 ~ 12000 kbps) automatically
 - Max transmission speed up to 12 Mbps for PROFIBUS and 115.2 kbps for COM Port

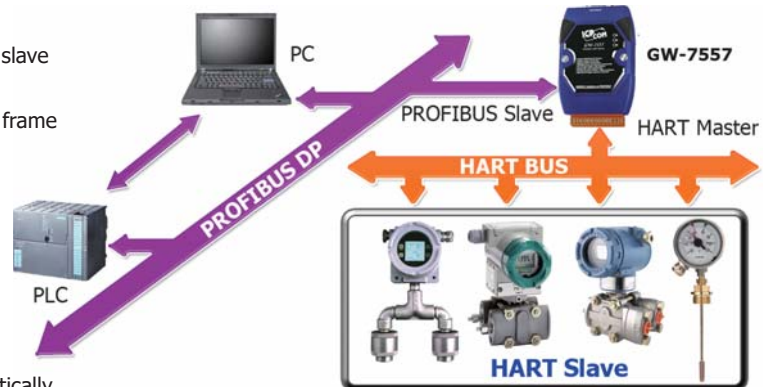

Available soon

HART Signal Filter

HRT-370



HRT-370 can receive a 4 to 20 mA DC current signal from HART device or control system analog output and passes the signal bi-directionally and uninterruptedly. Besides, HRT-370 also provides a HART interface to communicate with HART device. By using HRT-370, it can effectively isolate the HART device communication signal from control system analog signal.

- Support HART Burst mode
- Allow two HART masters
- Support HART Short/Long frame
- Support 4 ~ 20 mA current input
- 2-wire or 4-wire transmitters of HART
- Allow to connect to the Max. 15 HART modules
- Support the in point-to-point or multi-drop HART network

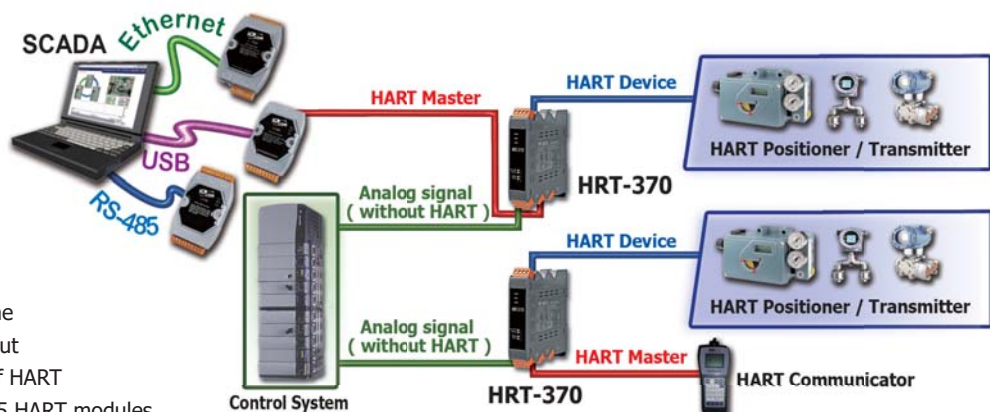

6.18 M-Bus Converters & Gateways

Model Name		Description
M-Bus Repeater	I-3591	M-Bus Repeater
M-Bus converter	I-7590	RS-232/422/485 to M-Bus converter
M-Bus gateway	GW-7828	Modbus RTU slave to M-Bus master gateway
	GW-7838	Modbus TCP server to M-Bus master gateway

Available soon

M-Bus Repeater

I-3591



The I-3591 is a M-bus repeater which could be a component of the M-bus system. It is designed for use in plants where extensive bus lines are required, or where large numbers of meters need to be connected, for example in district heat networks that supply heat to entire sections of towns.

- M-Bus to M-Bus Repeater
- Supports M-Bus slaves: 100
- Overcurrent detection
- Duplicate node id detection
- M-Bus Baud rate: Automatic baud rate detection
- M-Bus Data Format: Automatic data format detection

NEW

RS-232/422/485 to M-Bus converter

I-7590



The I-7590 is specially designed for M-Bus slave device. It offers RS-232, RS-422 and RS-485 three kinds of communication way. For the hardware of the I-7590, it has two rotary switches for serial port and M-Bus port baud rate. This design allows master baud rate to be different from the M-Bus slave baud rate. For the communication of the I-7590, it uses transparent communication. It solves the problem when performing protocol conversion between the master and the slave, and makes the communication easier. I-7590 is perfect for use when a new M-Bus device is added to an old RS-485 network or when the master firmware and configuration required not being changed.

- M-Bus Baud rate : Adjustable by rotary switch from 300 to 2400 bps
- Serial Baud rate : Adjustable by rotary switch from 300 to 115200 bps
- Default serial port data format: Data bit 8, Parity none, Stop bit 1
- Overcurrent and short-circuit protection on the M-Bus
- Update firmware from serial port
- Support up to 100 M-Bus slaves
- Provides transparent communication

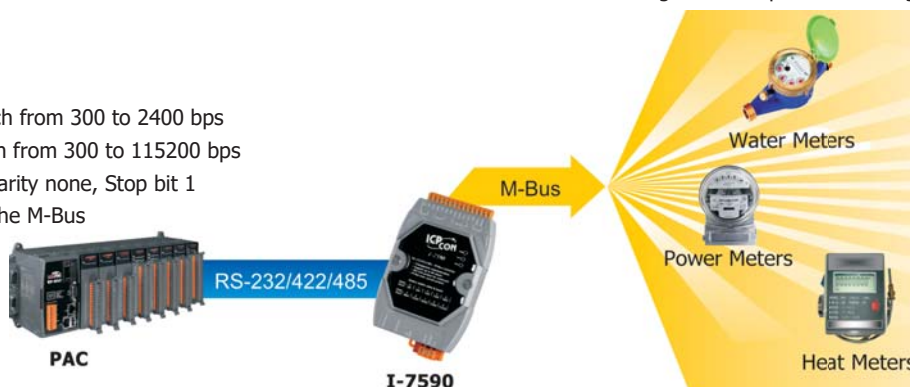

Modbus RTU/TCP to M-Bus Gateway

GW-7828



The GW-7828/GW-7838 gateway is a Modbus slave device that allows the Modbus RTU/Modbus TCP master to access the M-Bus slave devices. These M-Bus devices may be a water meter, electric meter, power meter and so forth. Owing to the GW-7828/GW-7838, you can put the M-Bus slave devices into Modbus network very easily.

- Support command request mode and cyclic request mode
- Modbus RTU baud rate: Support from 300 to 115200 bps
- Overcurrent and short-circuit protection on the M-Bus
- M-Bus baud rate : Support from 300 to 2400 bps
- Support up to 100 M-Bus slaves

GW-7838

Available soon

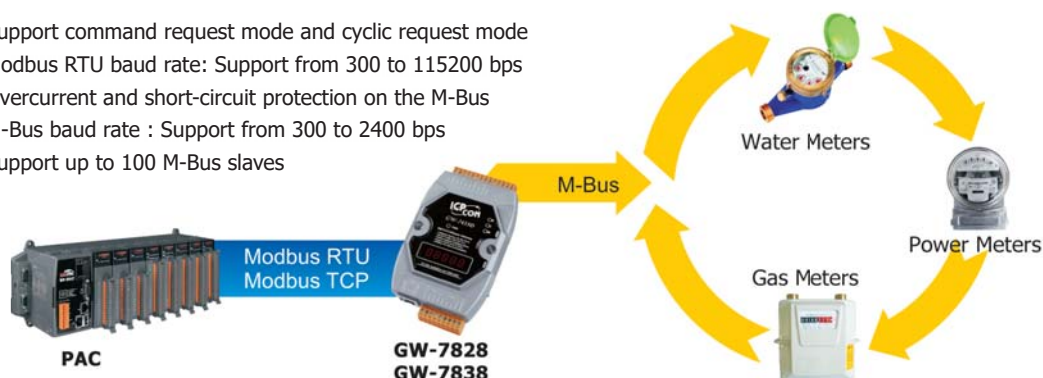

ICP DAS Catalogs & Brochure

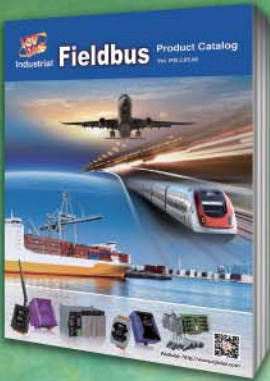

Industrial Fieldbus

- RS-485
- Industrial Ethernet
- Profinet
- CAN bus
- CANopen
- Devicenet
- J1939
- PROFIBUS
- HART
- Ethernet/IP
- BACnet



PC-based I/O Boards

- PCI Express Bus Data Acquisition Boards
- PCI Bus Data Acquisition Boards
- ISA Bus Data Acquisition Boards

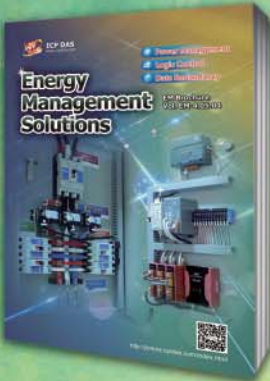

Energy Management Solution

- InduSoft SCADA Software
- Smart Power Meter Concentrator
- Smart Power Meter
- True RMS Input Module
- TouchPAD Devices - VPD Series



IIoT Product

- IoTstar: cloud management software
- UA-5200: communication server
- WISE series: IIoT host
- iCAM series: IP camera
- MQ-7200M series: MQTT I/O module
- Sensors: temperature, humidity, CO2, PM2.5,...



Machine Automation

- Motionnet Solutions
- EtherCAT Motion Control Solutions
- Ethernet Motion Control Solutions
- Serial Communication Motion Control Solutions
- PC-based Motion Control Cards
- PAC Solutions - Motion Modules

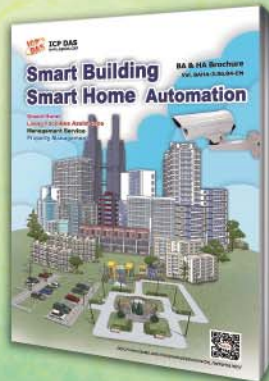

Smart Building, Smart Home Automation

- Video Intercom & Access Control
- Touch HMI - TouchPAD Series
- Smart Lighting Control
- Energy Saving - PM/PMC Series
- Environmental - DL/CL Series
- Motion Detector - PIR/RPIR Series
- Wi-Fi Wireless - WF Series
- Infrared Wireless - IR Series
- ZigBee Wireless - ZT Series
- IIoT Server & Concentrator
- Data Server - iDaSer Series
- LED Display - iKAN Series



TouchPAD HMI Solutions

- Introduction
- TPD/VPD Products Series
- Video Intercom & Access Control Series
- TPD/VPD Application



Remote I/O Modules and I/O Expansion Units Products Catalog

- RS-485 Products
- Ethernet Remote I/O Modules
- FRnet I/O Modules
- CAN Bus Products
- PROFIBUS Remote I/O Modules
- HART Products
- Smart Power Meter
- WISE I/O Module



ICP DAS CO., LTD.
Taiwan (Headquarters)

Website: <http://www.icpdas.com>

TEL: +886-3-597-3366

FAX: +886-3-597-3733

E-mail: info@icpdas.com

sales@icpdas.com



Local Distributor