



ICP DAS  
www.icpdas.com

# Energy Management Solutions

-  Power Management
-  Logic Control
-  Data Redundancy

EM Brochure  
Vol. EM-4.05.04

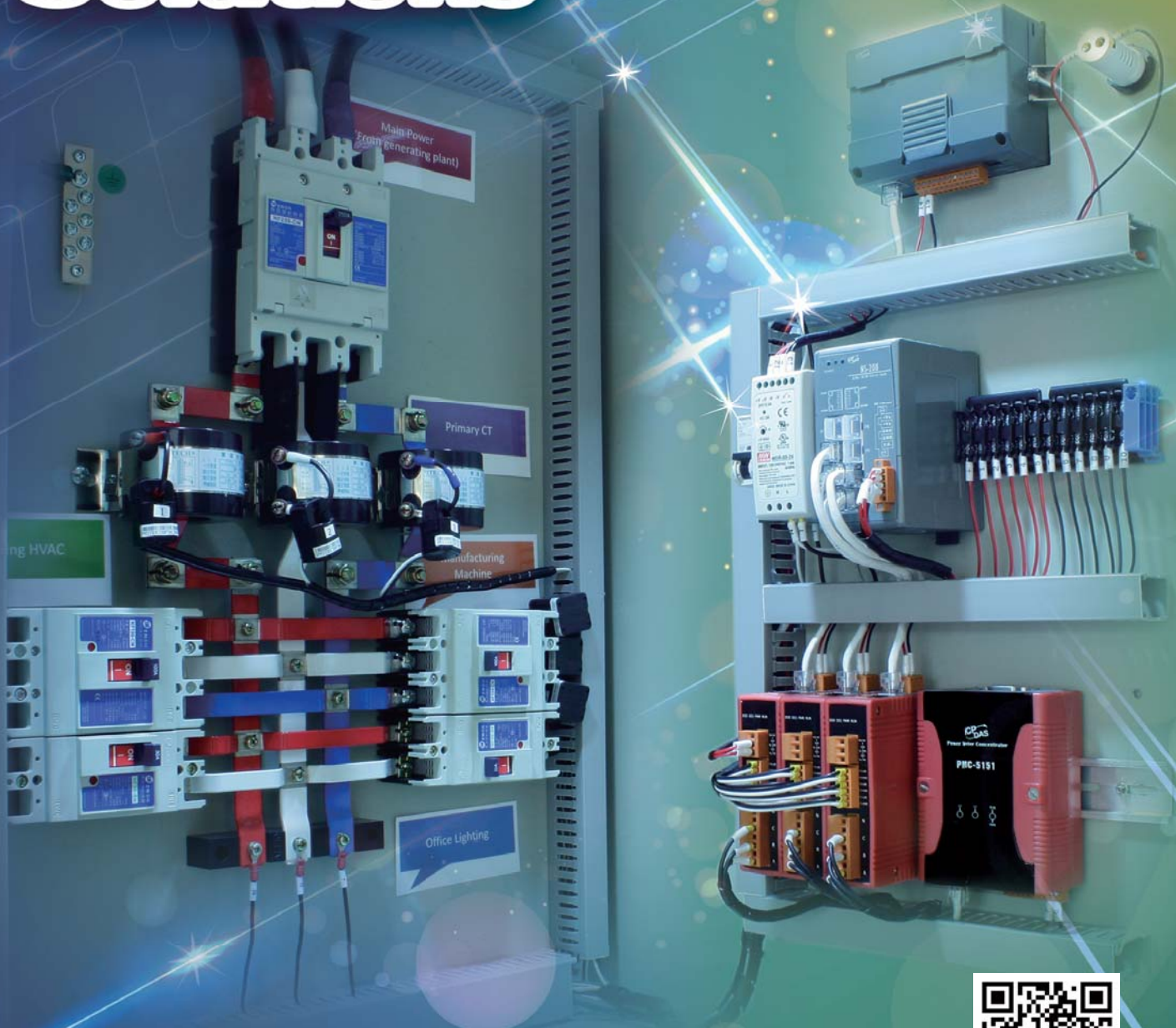

<http://pmms.icpdas.com/index.html>

# ICP DAS

# Energy Management Solution

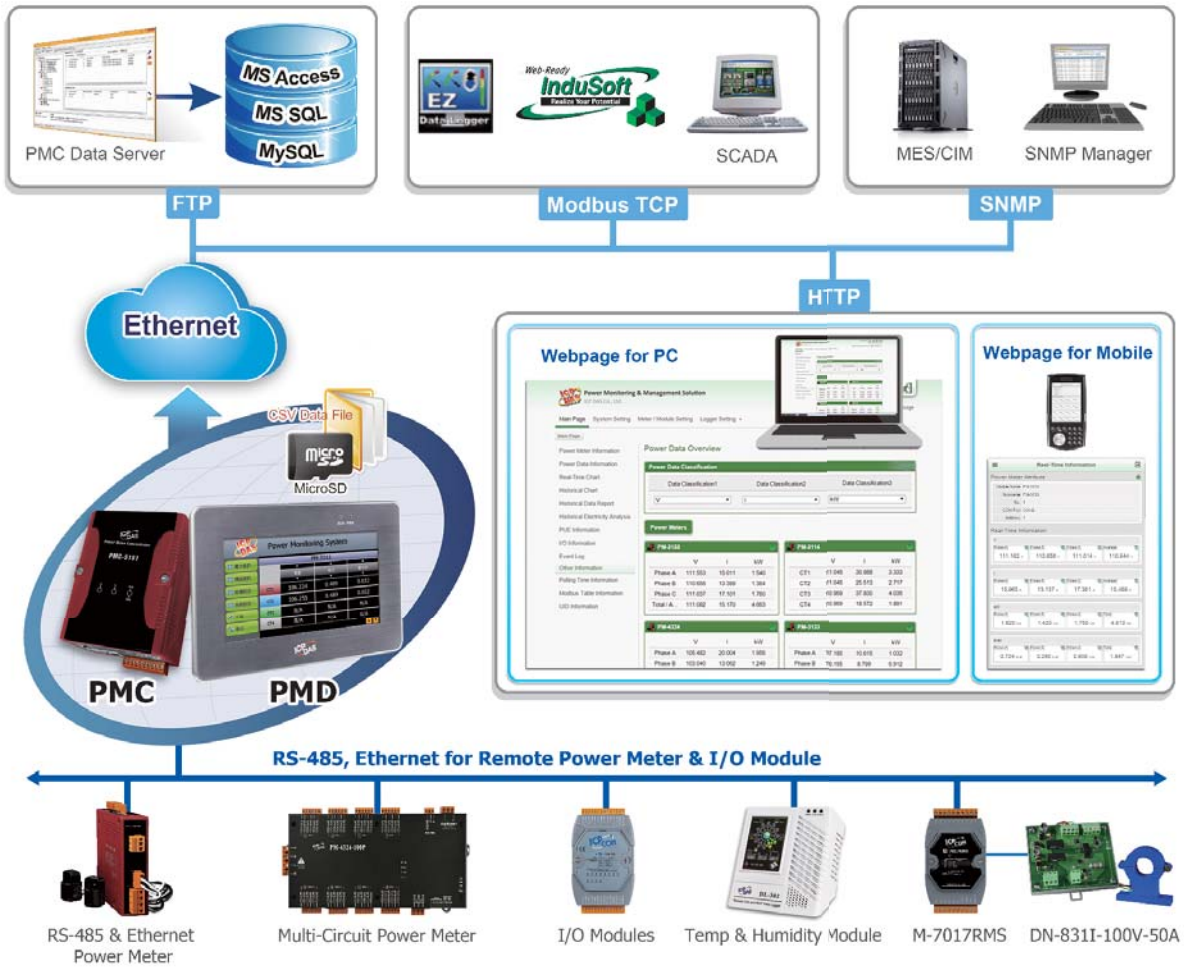

▲ System Architecture

For the resources of the earth are getting depleted faster in recent years, countries around the world and all walks of life all set off a wave of energy saving and carbon reduction in order to avoid the waste of resources and pursue living a sustainable life to extend earth's resources. Under the trend of energy saving and carbon reduction, power monitoring gradually becomes an important project for maximizing energy efficiency by power monitoring always contributing to significant energy savings no matter on the individual, corporate or national level. In order to achieve more efficient use of energy and reduce resources consumption, ICP DAS provides an innovative total solution in energy saving by connecting PMC/PMD (Power Meter Concentrator) to the Power Meters via RS-485 or Ethernet interface, it can measure and monitor the power consumption of the devices, machines, lighting, air conditioning or other electricity equipments. In addition, PMC/PMD also provides power demand management and alarm notification functions. With the integration of ICP DAS I/O modules and the standard Modbus I/O devices, it can perform logic control or load shedding of the devices based on the power demand in real time. PMC/PMD also supports Modbus TCP/RTU protocol for seamless integration with SCADA. So that the administrator can monitor the status of power consumption of each device and perform statistics and analysis of the power information, thus improving the overall efficiency in electricity consumption to save costs on utility bills.

This innovative total solution for energy saving includes: front-end Smart Power Meter, Power Meter Concentrator, back-end software tool for database import operation (PMC Data Server) and InduSoft SCADA software. In addition to hardware devices, ICP DAS also provides total solution so that the user could easily view power data by their mobile phones or PC, the administrator could set up the system quickly and the data can be recorded in real time for energy consumption inquiry to achieve effective energy saving. During the early stage, if the scale of the application is small, the user could simply use Smart Power Meter and PMC/PMD to set up a simple power monitoring system, once the scale of the application is expanded, the user could get the back-end software tool involved and build an easy-to-expand power monitoring system via blocks stacked structure. By this way, the system will be highly flexible and could be implemented in phases to meet various requirements.

# System Management Software

## InduSoft Web Studio

InduSoft Web Studio is a powerful, integrated collection of automation tool that includes all the building blocks needed to develop modern HMI, SCADA systems, and embedded instrumentation and control applications. InduSoft Web Studio supports all Windows runtime platforms (32/64 bit) and Windows Server Editions, and Linux OS now.

To implement energy saving solution, ICP DAS provides an example project that is based on InduSoft and is connected to PMC/PMD concentrators for power data acquisition. This example project features the following functions and can be a good reference for users to build their specific Energy saving solutions.

- Acquires data in real time from a variety of real world devices
- Displays and accesses real-time, dynamic, and animated graphic screens, trends, recipes, and reports on the most popular web browsers
- Import and exports data in a variety of formats for easy integration with corporate and business applications.
- Has a strong architecture that encompasses the latest standards and technology in wireless, mobile, distributed, and Internet based SCADA and HMI applications



## EZ Data Logger

EZ Data Logger is a small data logger software. It can be applied to small remote I/O system. With its user-friendly interface, users can quickly and easily build a data logger software without any programming skill. ICP DAS provides it for users to easily build a SCADA system.

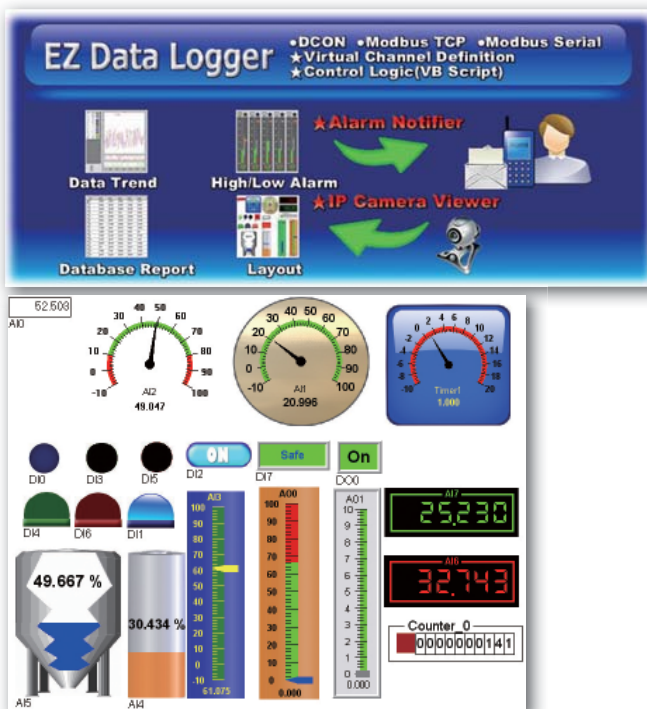

### Features:

- Support multiple protocols
  - DCON
  - Modbus RTU, Modbus ASCII, Modbus TCP
  - M2M RTU
- Support multiple COM Ports and TCP/IP connections
- Support Virtual Channel definition
- Support Control Logic (VB Script)
- Support Alarm Notifier (SMS or E-Mail)
- Flexible module/workgroup configuration
- Real time data trend (zoom in/out, records > 86400)
- Provide Layout view
- Provide IP Camera Viewer
- Access database supported (Excel or CVS file)
- Provide Reporter to print trend line or data
- Provide High/Low alarm with audio warning
- Can search ICP DAS modules (I-7000/8000/87K, M-7000)
- Provide Value scaling
- Support 3-level account
- Programming skill needless (Click mouse / enter value)

# Power Meter Concentrator

## PMC/PMD Features:

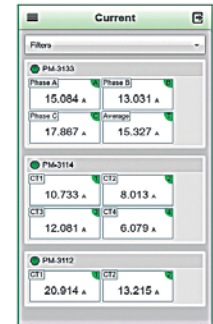
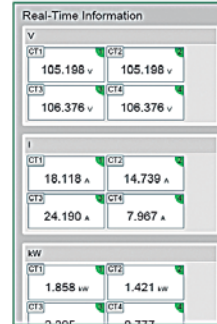

### No extra software tool, using browsers to perform system operations

Featuring web-based HMI for easy operations, the user could connect to PMC/PMD webpage via browsers to view the power data, set up system parameters, manage power demand and perform logic editing function for alarm notification.



### Built-in Micro SD card for power data logging

The PMC/PMD features a built-in Micro SD card. After the PMC/PMD retrieving the power data from the power meter, the system will save the power data in CSV format in the Micro SD card and regularly send back the data files to the backend management center for data analysis and statistics.

### Display real-time or historical power data trend

In addition to display power data of the power meter in text form, the power data can also be displayed in real-time and historical trend chart for user to easily identify the variation of the electricity usage of the devices.

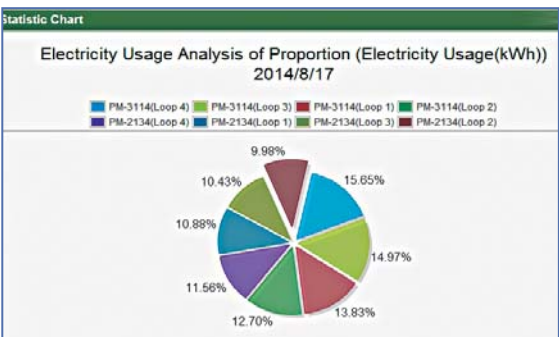
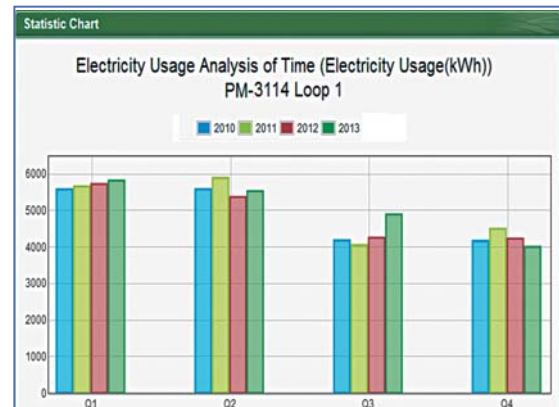
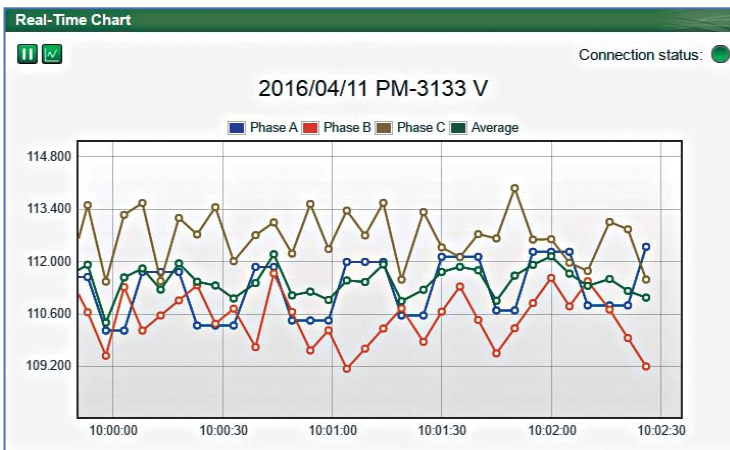

### FTP Server/Client for data file management and file recovery mechanism supported

The built-in FTP Client function of PMC/PMD allows regular transmission of the power data logger files saved in the Micro SD card of PMC/PMD to the backend management center for data analysis and statistics. The PMC/PMD offers a complete data file recovery mechanism so that when experiencing network disconnection, the data log files will be recovered after the network is resumed to ensure the system operates properly. With the FTP Server of PMC/PMD, the user could also use FTP Client utility to retrieve the power data files saved in PMC/PMD from the PC side easily.

**Built-in IF-THEN-ELSE logic engine for thought-out power demand management and auto alarm notification when unusual events occurs**

PMC/PMD is equipped with IF-THEN-ELSE logic engine. The user could complete the control logic via web page and download the logic rules to the PMC/PMD. The logic engine will loop execute the rules in order. By editing the IF-THEN-ELSE logic rules, the user could include the following information in the IF condition, such as: "fail to connect to power meter", "FTP upload failed", "insufficient disk space", "power demand management", "abnormal power data", etc. In addition, the Schedule setting and channel values of I/O modules that are connected to the PMC/PMD can be also included in the IF condition. When the evaluation of the IF condition is matched, the corresponding Action will be executed (such as: Email/SMS alarm message sending or AO/DO channel value of the I/O modules setting). By this way, the user could quickly implement applications for power demand management, electricity control of the devices and alarm notification sending.

The image shows two screenshots from the ICP DAS interface. The left screenshot, titled "Rule Overview", lists two rules. Rule 1: IF COM2 PM-3112(3:Room3) CT1 Actual Demand < 30, THEN COM2 PM-3112(3:Room3) DO0 = ON (One Time), ELSE COM2 PM-3112(3:Room3) DO0 = OFF (One Time). Rule 2: IF COM2 PM-3114(4:Room4) CT1 kW > 30, THEN COM2 PM-3114(4:Room4) DO0 = ON (One Time), ELSE COM2 PM-3114(4:Room4) DO0 = OFF (One Time). The right screenshot, titled "Rule Content Setting", shows a graphical configuration for a rule. It has three sections: IF, THEN, and ELSE. The IF section has a dropdown for "Add a new Condition:" with options like "Power Meter", "Connection Status", and "SD Card Status". A menu is open showing "Basic Values" with options like "Actual Demand", "Forecast Demand", "Hourly Maximum Demand", etc. The THEN and ELSE sections have dropdowns for "Add a new Action:" with an option "COM2 PM-3112(3 Room3) DO0 = OFF".

**Provide Schedule function**

PMC/PMD provides Schedule function that allows to edit logic for applications that requires Schedule function. The Calendar interface allows to easily set up the schedule for weekdays or weekends so that the user could schedule the operations for the devices as required for power saving.

The screenshot shows the "Schedule Content Setting" interface. It includes a "Mode" section with "Calendar" selected and "Repeat" unselected. A "Date" section has "Starting Month" set to 2013 and "November" selected, with a "Duration" of 3 months. A "Time Range(s)" section shows a range from 08:00:00 to 17:00:00. Below these are buttons for "Select All", "Unselect All", "Select Weekday", and "Select Weekend". At the bottom, there are three calendar grids for 2013/11, 2013/12, and 2014/1, with days marked as "In Range" (green) or "Out of Range" (grey).

**Provide historical power data statistics report**

PMC/PMD provides historical data report inquiry and display function, the easy-to-read daily and monthly report of the historical power data would help to understand current electricity usage of the devices.

The screenshot shows a "Central Air Conditioning - Monthly Report" table. The table has columns for Date, Max. Demand (kW), Avg. PFD(S), L<sub>1</sub>(A), L<sub>2</sub>(A), L<sub>3</sub>(A), V<sub>L1</sub>(V), V<sub>L2</sub>(V), V<sub>L3</sub>(V), kVA Tot.(kVA), and kvar Tot.(kvar). The data spans from 2015-08-01 to 2015-11-31. At the bottom, there are summary statistics: Total Electricity: 3633.401 kWh, Monthly Highest Usage: 1625 kW, and Occurrence Time: 2015/10/10/4.

**Modbus TCP/RTU for seamless integration with SCADA**

The PMC/PMD supports Modbus TCP/RTU Slave protocol to connect to SCADA software or HMI devices in control center so that it could perform real-time monitoring and control of the electricity usage for the devices. Therefore, the regulation of the system will be more flexible.

**Provide Timer Function**

Timer function provides Timeout/Not Timeout status for condition evaluations. With the timer function, the users are able to edit logic that requires timing approach. In addition, the timer function can be reset/started in real time that increases flexibility when performing logic control.

**Support a variety of wide-range I/O modules to achieve power control and load shedding of the devices**

According to the requirements of the application and based on the devices connected, the PMC/PMD is able to connect to M-7000 I/O modules, standard Modbus TCP/RTU Slave modules or DO Relay channel of the PM Series power meter for real time I/O control operation of the devices, the abundant selections enable maximum flexibility for system set up and power saving.

Meter / Module Setting Page

XW-Board: None

COM2 | Modbus RTU Master

No.	Module Name / Nickname	Address	Polling Timeout(ms)
1	ICP DAS PM-3133(Room1)	1	1000
2	ICP DAS PM-3133(Room2)	2	1000
3	ICP DAS PM-3112(Room3)	3	1000
4	ICP DAS PM-3114(Room4)	4	1000
5	M-7018Z(Temp. Monitor)	5	300
6	M-7060(Power Control)	6	300

I/O Information

Options: M-7060(6:Power Control)

DI

Ch.0	Ch.1	Ch.2	Ch.3
OFF	OFF	OFF	OFF
Counter: 0	Counter: 0	Counter: 0	Counter: 0

DO

Ch.0	Ch.1	Ch.2	Ch.3
OFF	OFF	OFF	OFF

I/O Information

Options: M-7018Z(5:Temp. Monitor)

AI

Ch.0	Ch.1	Ch.2	Ch.3	Ch.4
0.000 °C	0.000 °C	0.000 °C	0.000 °C	0.000 °C
Ch.5	Ch.6	Ch.7	Ch.8	Ch.9
0.000 °C	0.000 °C	0.000 °C	0.000 °C	0.000 °C

**On-Site Power data viewing and Power Meter setting**

PMD (Power Meter Concentrator with Display) series is equipped with TFT LCD (with Touch Panel). It provides an easy way for viewing the power data and set up the Power Meter parameters on sites.



**Support SNMP Function**

In addition to Modbus protocol, PMC/PMD also supports SNMP function that allows seamless integration with IT Management software. The users could integrate PMC/PMD with the existing management system and collect the power data of each device by SNMP function easily.

**Provide "Power Usage Effectiveness (PUE)" calculation operation**

Power usage effectiveness (PUE) is a measure of how efficiently a computer data center uses energy; specifically, how much energy is used by the computing equipment (in contrast to cooling and other overhead). PUE is the ratio of total amount of energy used by a computer data center facility to the energy delivered to computing equipment. The PUE will be greater than 1. The larger the PUE number the less efficient your utilization is. PMC/PMD provides the PUE calculation operation and also display the PUE data in two modes (Real-Time and History) through Web page.

Power Usage Effectiveness(PUE) Information

Real-Time | History

<p>1</p> <p>PUE 1</p> <p>2.310</p> <p>Total Facility Energy: 4856.21 kWh</p> <p>IT Equipment Energy: 2101.92 kWh</p>	<p>4</p> <p>PUE 4</p> <p>4.317</p> <p>Total Facility Energy: 4856.21 kWh</p> <p>IT Equipment Energy: 1125.00 kWh</p>
<p>7</p> <p>PUE 7</p> <p>1.981</p> <p>Total Facility Energy: 3226.92 kWh</p> <p>IT Equipment Energy: 1629.29 kWh</p>	<p>10</p> <p>PUE 10</p> <p>1.505</p> <p>Total Facility Energy: 4856.21 kWh</p> <p>IT Equipment Energy: 3226.92 kWh</p>

# Smart Power Meter & Devices

## PM Smart Power Meter Features

- Provide multi-phase multi-circuit power measurement function

PM-3033: 1 Three Phase Circuit

PM-3133: 1 Three Phase Circuit

PM-3112: 2 Single Phase Circuits

PM-3114: 4 Single Phase Circuits

PM-4324: 8 Three Phase Circuits or 24 Single Phase Circuits

- Support multiple communication interfaces:

- RS-485
- Ethernet
- CANopen

- Support multiple standard communication protocols:

- Modbus RTU
- Modbus TCP
- CANopen

- Support 2 built-in Power Relay Output

- With CT W Accuracy Better than 0.5% (PF=1)

- Clip on CT for easy installation

- Compact size, easy to install, suitable for a variety of industrial applications

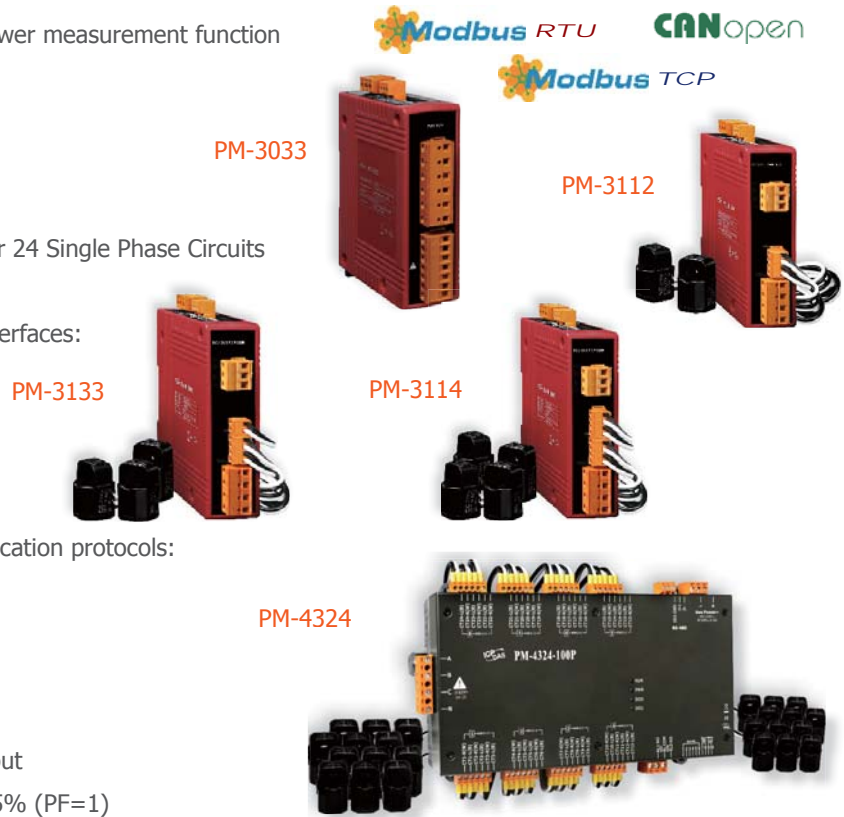

## True RMS Input Module Features

M-7017RMS



Modbus RTU  
DCON

- 8-channel True RMS Input
- ±0.15% Factory Calibrated Accuracy
- RMS Input Range: +150 mVrms ~ +10 Vrms
- For Standard Operation with Frequencies: 45 Hz ~ 10 KHz
- Individual Channel Configurable
- 4 kV ESD Protection
- ±35 VDC Overvoltage Protection
- 2500 VDC Intra-module Isolation

## Industrial Multi-power-meter Display

7" Series



TPD-703-PM

VPD-173-PM

4.3" Series



TPD-433-PM

VPD-143N-PM

Modbus TCP  
Modbus RTU

- Built-in HMI for Information Display of Power Meters
- IP40/IP60 Ingress Protection for Front Panel
- Support Modbus TCP/RTU Protocols
- Support Max. of 8 Single-phase/3-phase Power Meters (PM-3xxx series) or One PM-4324
- Support Max. of 4 Modbus/TCP Connections for SCADA Software
- Support Phase Sequence Detection
- Support Fine Tune of Voltage and Current Ratio

# Software Utility

**PMC Data Server**

The PMC Data Server is a database utility designed for connecting to the PMC/PMD concentrators. When PMC/PMD Data Server is connected to these PMC/PMDs by Ethernet, the PMC/PMDs will send the power data logger files to the PMC Data Server at scheduled time, and these power data will be transformed to MS Access/MS SQL/MySQL database format for easy data review or inquiry. During the whole process of system development, no programming is required. It takes only a few settings for users to quickly retrieve and view the power data of the devices based on database system and furthermore, enables further process of the data for statistics and analysis.

**Power Meter Utility**

Power Meter Utility has to be installed on PC and it enables to retrieve and display the power measurement values that measured by power meter via COM Port or Ethernet. The users will be able to read the power measurement values and to perform parameter settings of the meter. When connecting with ICP DAS power meters by RS-485 communication protocol interface, it requires to convert RS-232 or USB on PC to RS-485 communication interface, converter modules (such as ICP DAS I-7561, I-7520) might be required; When connecting with ICP DAS power meters by Ethernet interface, it must setup the correct IP address to retrieve the power measurement values easily.

**Features:**

- By Modbus RTU or Modbus TCP protocol, it enables to connect with ICP DAS Power Meters and data retrieving.
- Real time monitor power measurement values of the meter.
- Real time setting up parameters of the meter.
- Restore the parameters of the meter to default settings.
- Support Data Log function

The screenshots show the software interface for ICP DAS Power Meter Utility v1.12. The top window displays 'Connection Setting' with options for Modbus RTU and Modbus TCP, and fields for COM port, baudrate, and meter ID. The middle window shows 'Meter Parameter Information' with fields for meter type, wiring type, and firmware. The bottom window displays 'Realtime Power Measurement' with a table of data for four channels and a 'Data Log' section.

Channel	Voltage	Current	kW	kvar	kVA
Channel 1:	109.60930	1.00256	0.09137	0.00811	0.09173
Channel 2:	109.60930	1.00024	0.09132	0.00818	0.09169
Channel 3:	109.66820	1.00358	0.09127	0.00942	0.09176
Channel 4:	109.66820	1.00461	0.09117	0.00946	0.09166



# Applications

## Factory

Electricity consumption always plays an important role in factory operations. With the limited availability of the energy sources, countries all over the world all seek to enforce legal regulations in energy saving and carbon reduction; as the cost of energy is getting higher and higher, any factories in the world are paying more attention to energy and resources optimization. For effective usage of the energy not only reduce the electricity cost but also stabilize the power system to maintain the normal operation of the production line.

The PMC/PMD developed by ICP DAS is perfect for building a power monitoring system for factory applications. It will send out real-time notification when there is unusual electricity consumption, and will perform load shedding in real time when the forecast capacity is going to exceed the contract capacity to avoid penalties. And by working with SCADA software, it enables gathering and analysis of the power data to design best power policy to enhance the efficiency of power supply.

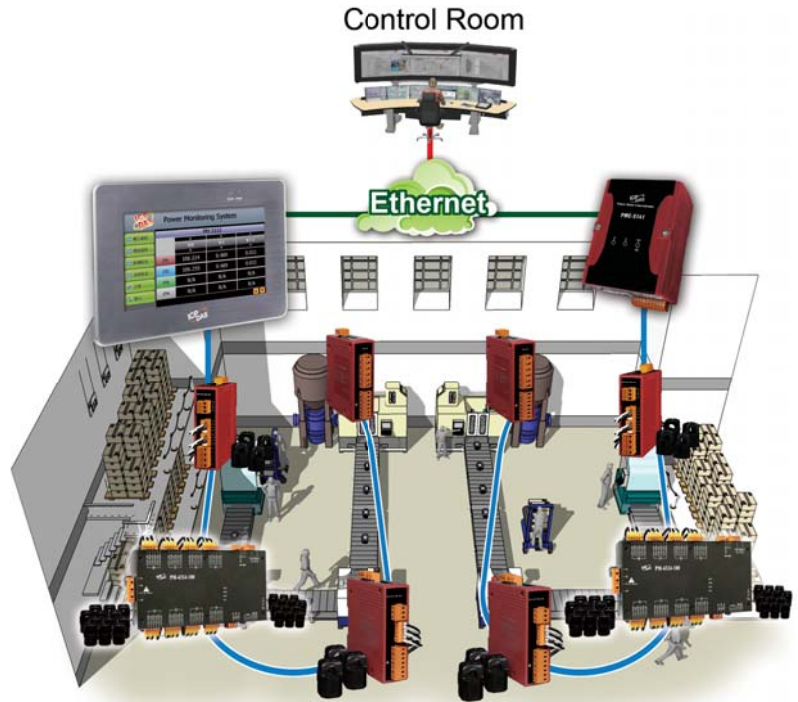

## Building

ICP DAS power monitoring and management solution is perfect for large-scale power monitoring for buildings. A PMC/PMD can be installed on each floor and connect to ICP DAS smart power meters via RS-485 or Ethernet interface to measure the power information of air conditioning, lighting, drainage or other electrical devices. The power information of the devices such as voltage, current and kilowatt information will be recorded in real-time and the data can be transmitted to back-end control center. With SCADA software, it can perform data gathering and analysis of the power data. By collecting electricity data, analyzing electricity data, identifying the problems and correcting improper behaviors on the electricity usage, the efficiency of power usage can be enhanced and furthermore, ensure stable power supply and energy saving.

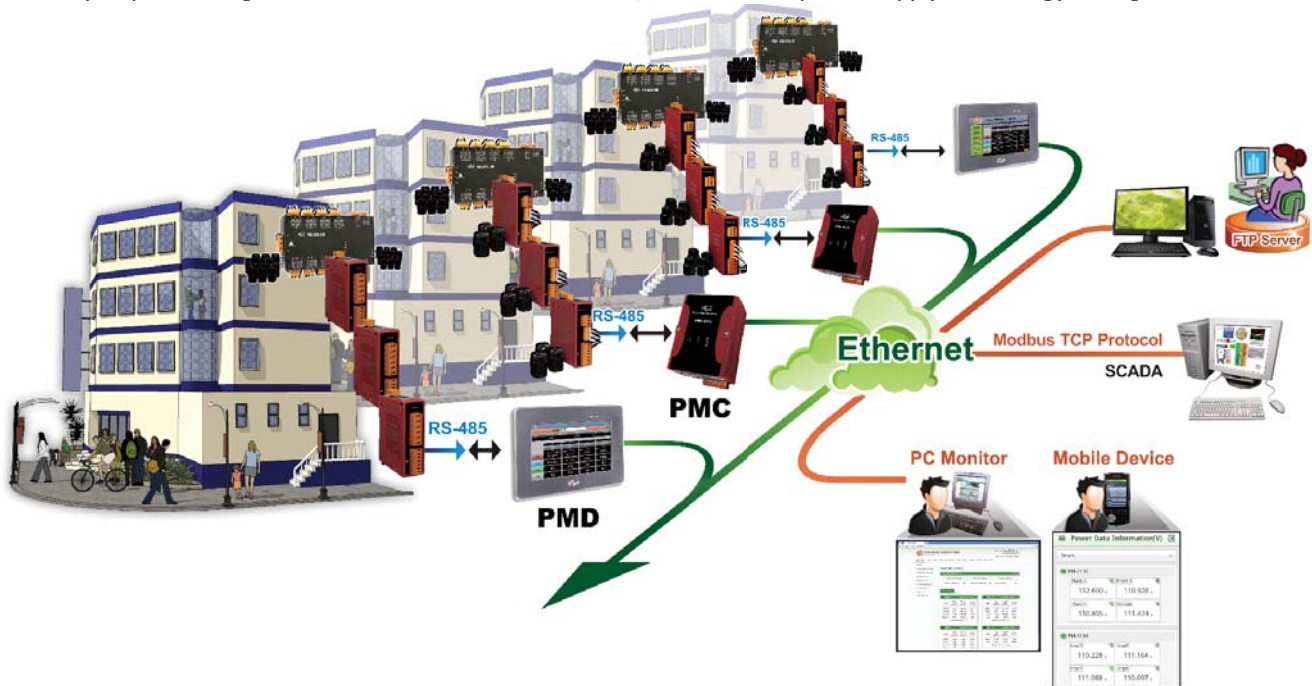

## Campus

ICP DAS provides a total solution for campus electricity monitoring and management. The related personnel could set up the alarm message notification operation according to the contract they signed. When the electricity consumption is going to exceed the contract capacity, the PMC/PMD will send SMS or e-mail notifications to related personnel for immediate actions. At the same time, it can perform load shedding to avoid penalties for exceeding contract capacity. By collecting and analyzing the power data of each device, the electricity consumption can be fully tracked and further more is able to establish effective policy to achieve energy saving and carbon reduction.

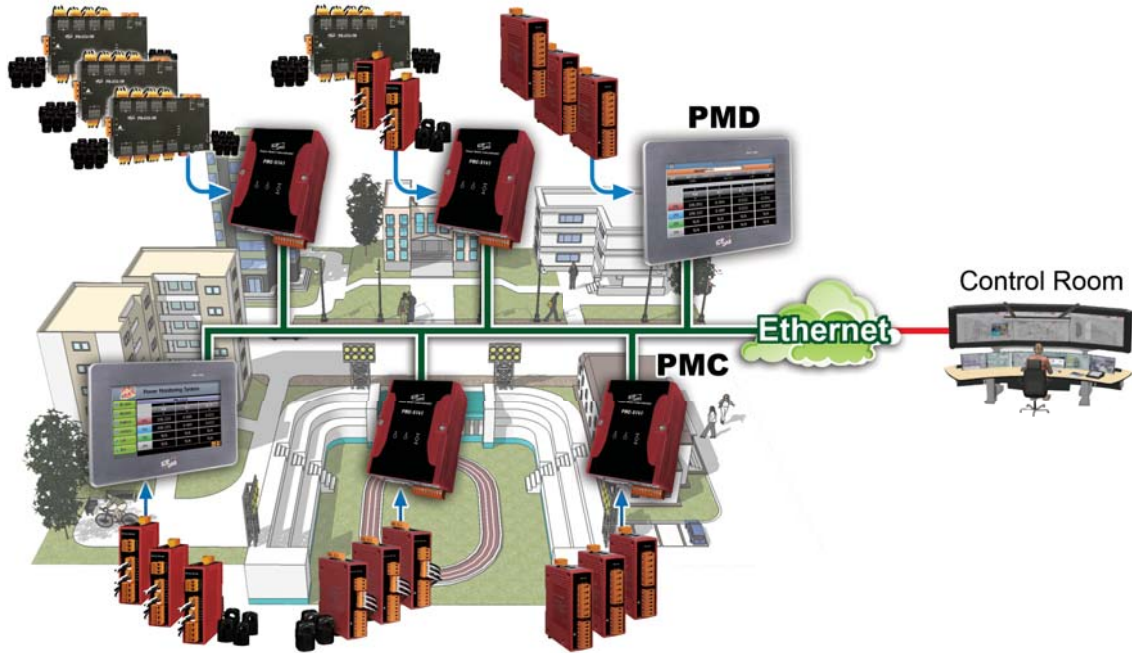

## Commercial Buildings

ICP DAS PMC/PMD solution can be used to build a power monitoring and management system specifically designed for a certain shopping center according to its requirements. By using ICP DAS PMC/PMD concentrators and smart power meters, it could measure and record the power data such as the electricity consumption for air conditioning, lighting, refrigerator or other electrical information of each store, and is able to send back the power data to the management center for further analysis.

With the Schedule, power demand management and alarm message notification functions, the system can perform the following operations according the actual requirements of the stores:

1. Time-based air conditioning control and management.
2. Time-based lighting control and management.
3. Monitoring & control of electricity consumption & demand.



### Electricity Consumption of Machines

In order to ensure the stability and reliability of the machines; usually it requires the monitoring of electricity consumption. The purpose is not only for energy saving, but also to investigate the influence of electric current variation that may affect the yield rate of the products during the production process. For most machines uses both AC and DC power supply, if the traditional power meters are used, it may require several power meters to implement the monitoring jobs. By using M-7017RMS, it can monitor multiple circuits at the same time and support both AC and DC current monitoring; so that it will save the installation space and no need to install lots modules for individual functions.

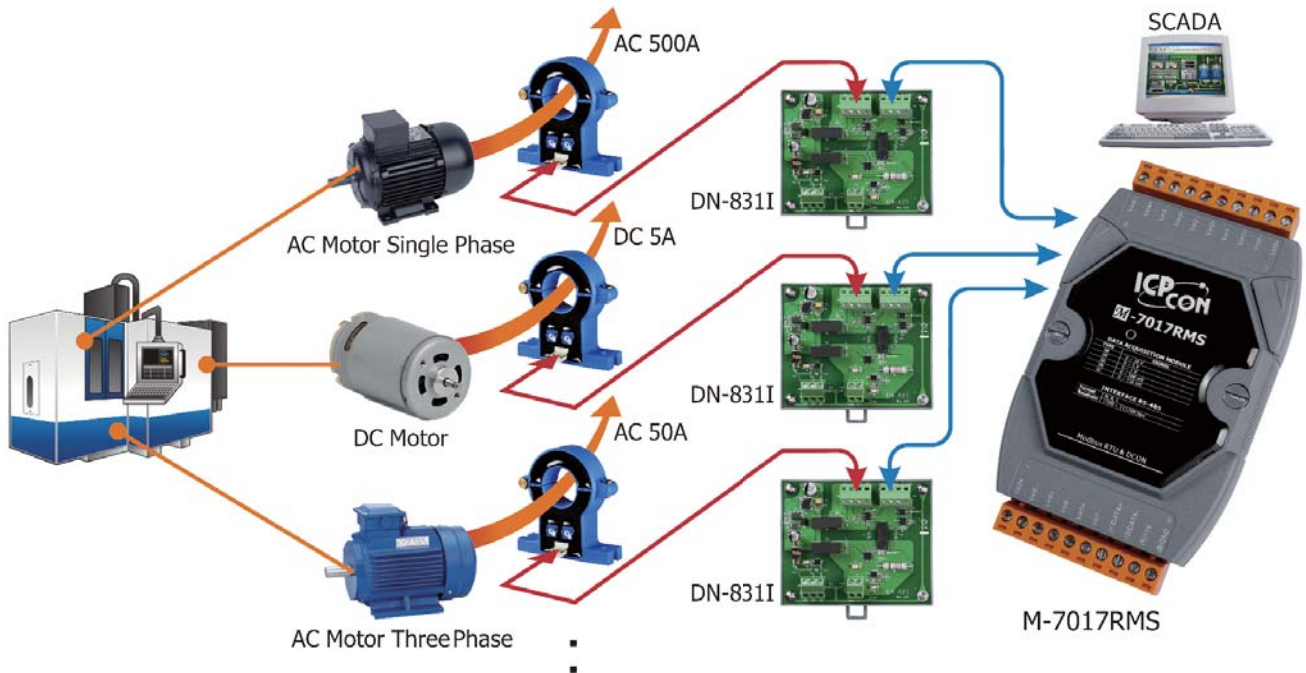

### Multi-circuit Smart Power Meter Touch Display

ICP DAS Smart Power Meter with the compact size provides high-quality measurement accuracy. If customers need to display the power information in the field side, ICP DAS provides the solution of 4.3" or 7" industrial multi-smart-meter display with built-in HMI of smart meter. Through the communication mechanism, the data of the multiple power meters can be presented on the screen of the display, customers can provide this solution in the local end. Furthermore, the data can be integrated into the background SCADA control system, not only to get the power information, but also to facilitate the integration and configuration. Most multi-circuit meters are often difficult to display the numerical data in the local end, but our multi-power-meter displays can provide the multi-circuit power information on one display by switching the page, so that the officer in the field side can quickly understand the power current status.

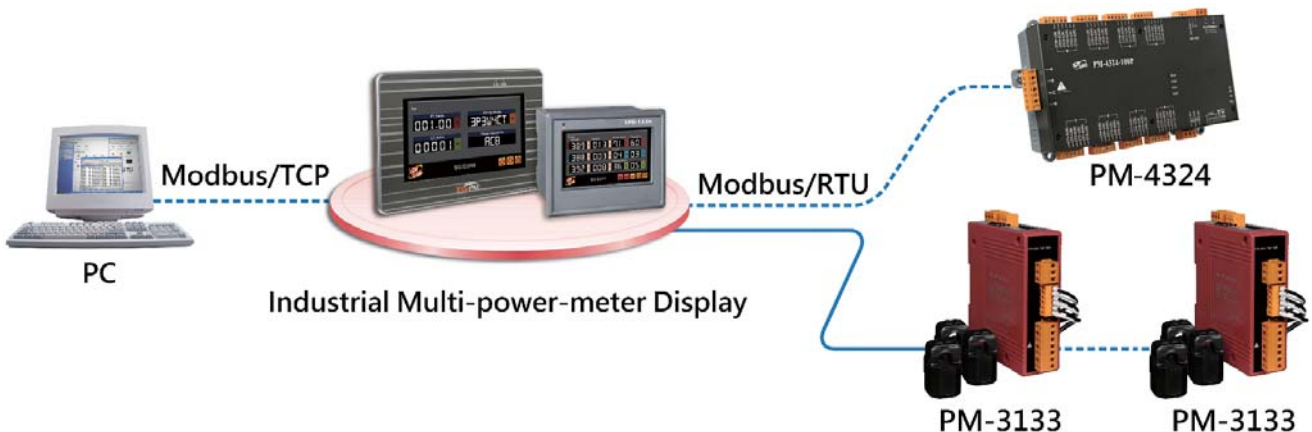

# InduSoft SCADA Software



InduSoft

## InduSoft Web Studio®

### Introduction:

InduSoft Web Studio is a powerful and reliable cross-platform software tool that integrates all the building blocks needed to develop modern Human Machine Interface (HMI), Supervisory Control and Data Acquisition (SCADA) systems, and embedded instrumentation that is specially design for use in automation applications. It features user-friendly Graphic Design tools command over graphics and animation operations, well-thought-out access control management, and intelligent remote diagnosis and control.

InduSoft Web Studio supports all Windows runtime platforms (including 32 and 64 bit), Windows Server Editions, and embedded Windows. The cross-platform feature allows the users to select OS environment of their choice and the same project can be deployed to different platforms without developing specific project for each platform, along with built-in support for local or remote (web) based visualization. InduSoft also conforms to industry standards such as Microsoft .NET, OPC, DDE, ODBC, XML, and ActiveX.

### InduSoft Features:

#### Graphics and Design Tools

Create screens to meet any application requirement using the tools in our graphic interface. Combine built-in objects to create any functionality required. Store graphics in the library for future use, and easily make projects across a product line share a consistent "look and feel".



#### Scripting

Two powerful scripting languages are supported; built-in InduSoft functions and standard VBScript. Take advantage of widely available resources for VBScript. Both the native InduSoft scripting language and VBScript can be used simultaneously to give you the functionality you need, even from thin clients.

#### Security and Intellectual Property Protection

InduSoft includes support for group and user accounts, e-signatures, and tractability. Also in InduSoft, HMI screens, documents, scripts and worksheets can be individually password protected.

#### Alarms & Events

Alarms are real-time and historical, log data in binary format or to any database. Other than all the alarm functions you'd expect, InduSoft Web Studio v7.1 also sends online alarms or reports using multi-media format like PDF. InduSoft offers traceability for operator initiated actions or internal system activity. Log events such as security system changes (user logon or off), screen open/close, recipe/report operations, system warnings, and any tag value changes, including custom messages.

#### Thin Client

Remotely view HMI screens as web pages using Internet Explorer web browser, or InduSoft Secure Viewer. Use SMA (Studio Mobile Access) to monitor or access process values and alarms with remote devices such as tablets and mobile phones. Enhanced SMA of InduSoft offers data in easy-to-read widgets that can be viewed on any HTML5 based web browser found on iPads, and Android phones and tablets.

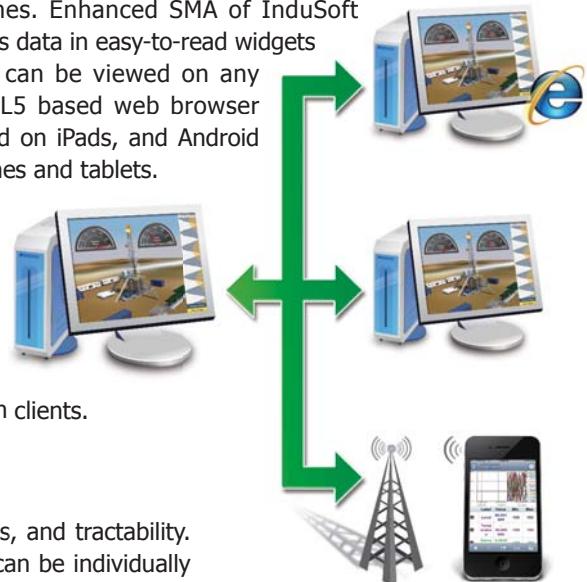

### Create once, runs on various platforms

By using InduSoft Web Studio, the user only need to create the project once at PC side, and then the project can be downloaded and run on various configurations of platforms, ranging from the Windows XP/7/8/10 to the simple handheld PDAs and "smart phones" that use Windows CE/Windows Mobile technology. It also runs on diskless embedded processors and Panel PCs. The cross-platform feature allows the users to select OS environment of their choice and the same project can be deployed to different platforms without developing specific project for each platform.

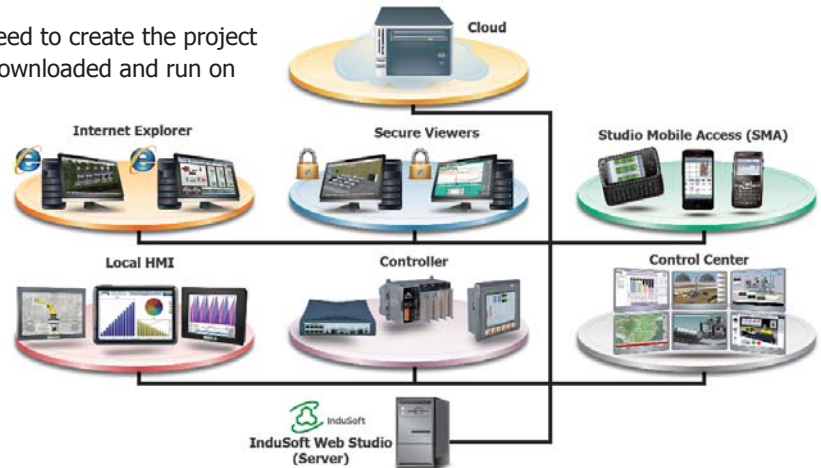

### Trends

Real-time and Historical trends are supported. It can log data in binary format or to any local or remote SQL database. Color or fill trends with graphic elements to enhance clarity of data. Date/Time based or numeric (X/Y plot) trends give you the flexibility to display information that best suits your application. InduSoft Web Studio supports vertical and horizontal trending.



### Redundancy

InduSoft Web Studio publishes HMI screens as web pages either to Internet Explorer or Secure Viewer. The HMI screen graphics are published as html pages via a "web server". The data is published via a "data server". InduSoft features:

- Support for redundant web servers
- Support for redundant data servers

InduSoft also allows connections to databases. Databases can be used to log data from Alarms, Events or Trends. The "Grid" object can interact with database directly for "Redundant" operation and "Store and Forward" operation.

### Drivers and OPC

IWS not only provides over 240 native communication drivers but also native OPC interfaces, such as OPC DA (Server/Client), OPC HDA(Server), UA (Client) and OPC .NET 3.0 (Client). InduSoft Web Studio also supports OPC XML as an additional add-on.

### Recipes and Reports

InduSoft provides flexible recipe management tools to save time and maintain consistency by automating part parameters or production quantities. The report tools allows user to create clear, concise reports in plain text, RTF, XML, PDF, HTML, and CSV or integrate with Microsoft Office programs such as Excel. Get the data you need, in the format you require to make decisions fast.



### Database

Connect to any SQL database (MS SQL, MySQL, Sybase, Oracle), or MS Access or Excel, and ERP/MES systems (including SAP), even from Windows Embedded CE. InduSoft Web Studio is flexible, offering a built-in interface that doesn't require knowledge of SQL.

### InduSoft Ordering Information

<b>IWS Development Package for Windows</b>	InduSoft development package can generate applications for Windows, Windows Embedded and Windows Embedded CE
<b>IWS Runtime Package for Windows</b>	InduSoft runtime package for Windows, Windows Embedded
<b>IWS Runtime Package for Windows Embedded CE</b>	InduSoft runtime package for Windows Embedded CE
<b>Additional Package for Development or Runtime License</b>	The additional package are number of Web Thin Clients, number of Secure Viewer Thin Clients, number of SMA Thin Clients, number of Communication Drivers, and Communication Add-Ons

# Power Meter Concentrator



**PMC-5151**

## Features

- No extra software tool is required, using browsers to operate system
- Support at most 24 ICP DAS Modbus Power Meter and 8 Modbus I/O modules (COM2, COM3 and LAN interface can connect to Max. 16 power meters.)
- Display real-time or historical power data (in data table or chart form)
- Provide power data statistics report (Daily and Monthly report)
- Data file auto send-back & recovery when network is resumed after disconnection
- Built-in IF-THEN-ELSE logic engine for power demand management
- Provide alarm message notification function via Email or SMS (for SMS message sending, GTM-203M-3GWA is required)
- Adjust device operations by its power status via Modbus I/O modules
- Provide Schedule function for operations of I/O modules (devices)
- Support Modbus TCP/RTU Slave protocol for seamless integration with SCADA
- Support Standard SNMP Protocol



## Introduction

The PMC-5151 is a web-based intelligent Power Meter Concentrator developed by ICP DAS. It offers webpage interface, and features various functions such as: power data collection, logic control, power demand management, data logger and alarm notification functions. PMC-5151 allows connections to ICP DAS Smart Power Meters via RS-485 or Ethernet interface to read the power data of the devices measured by the power meters; and then real-time record the power values in the data logger file. It also provides data logger file auto send-back function; together with PMC Data Server software or SCADA software, it allows collection and analysis of the power data.

## Applications

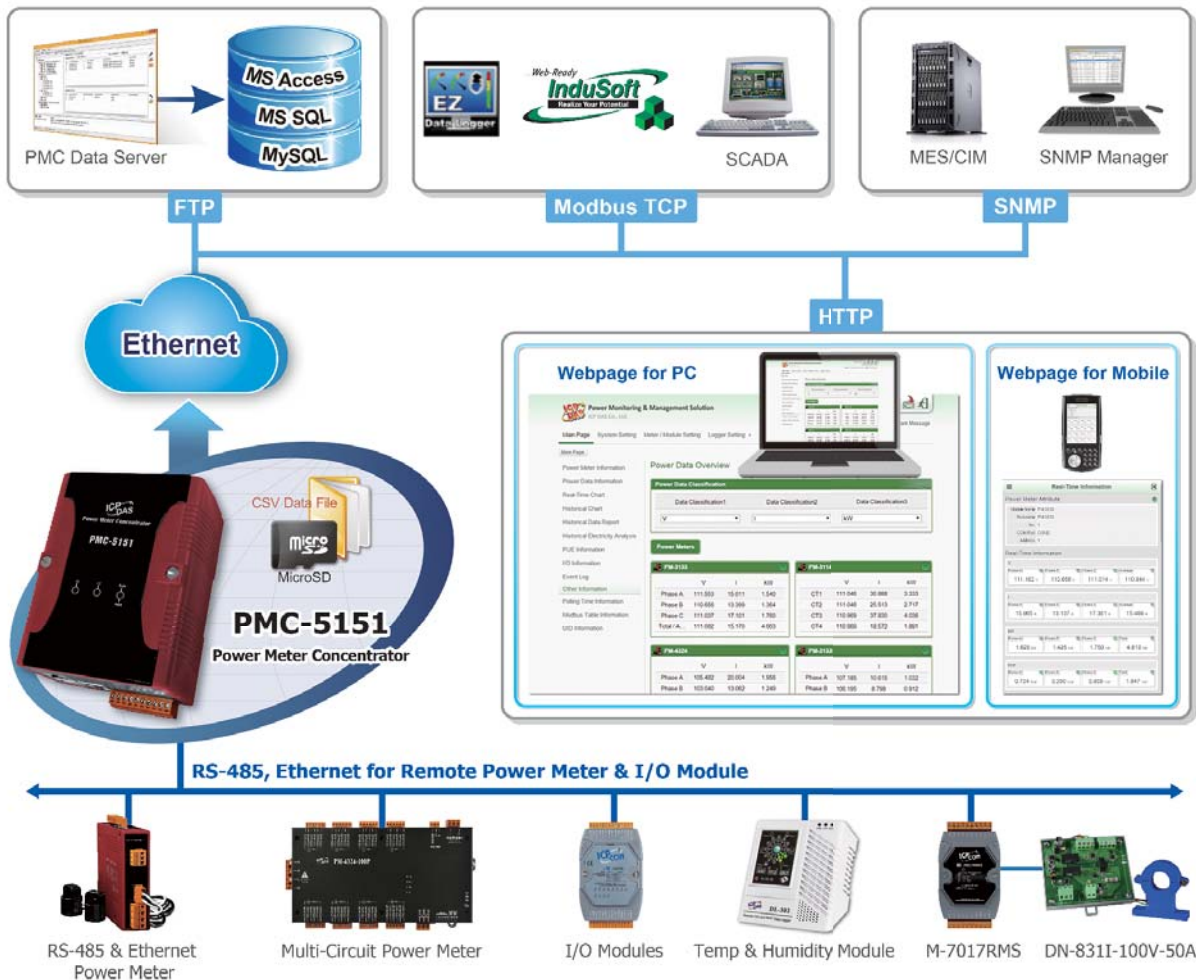

PMC-5151 is equipped with built-in Web Server that allows direct connections via browsers to the PMC-5151 for viewing power data and setting up the system parameters. It also offers Modbus TCP/RTU Slave function that allows SCADA software or HMI devices to connect to PMC-5151 to get real-time power data of the devices via Modbus TCP/RTU protocol. In addition to ICP DAS XW-Board and M-7000 I/O modules, the PMC-5151 can also connect to standard Modbus TCP/RTU Slave modules. By working with the I/O modules, and functions such as IF-THEN-ELSE logic rule execution and alarm notification functions including Email/SMS/SNMP Trap, PMC-5151 offers more thought-out power demand management and alarm notification functions, and is able to perform load shedding of the devices if required, and enables real-time monitoring and control of the power consumption of the devices.

**Specifications**

Model	PMC-5151
<b>System Software</b>	
Embedded Service	PMC Runtime · Web server · FTP server
Memory Expansion	microSD socket with one 4 GB microSD card (support up to 16 GB microSDHC card)
<b>Communication Ports</b>	
Ethernet	RJ-45 x 2, 10/100 Base-TX (Auto-negotiating, Auto MDI/MDI-X, LED indicators)
USB 1.1 (client)	1
USB 1.1 (host)	1
COM 1	RS-232 (Rx/D, Tx/D and GND); non-isolated; can connect to SMS Modem (GTM-203M-3GWA)
COM 2	RS-485 (D+, D-); 2500 VDC; isolated
COM 3	RS-485 (D+, D-); 2500 VDC; isolated
<b>Environmental</b>	
Operating Temperature	-25 ~ +75°C
Storage Temperature	-30 ~ +80°C
Ambient Relative Humidity	10 ~ 90% RH (non-condensing)
<b>Power</b>	
Input Range	+10 ~ +30 VDC
Consumption	4.8 W (0.2 A @ 24 VDC)

**Dimensions (Units: mm)**

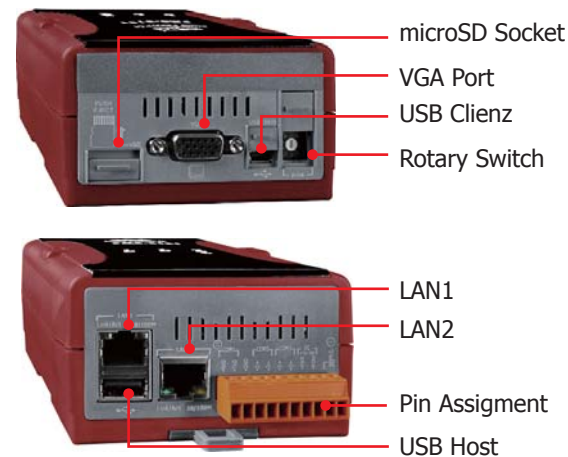

**Appearance**

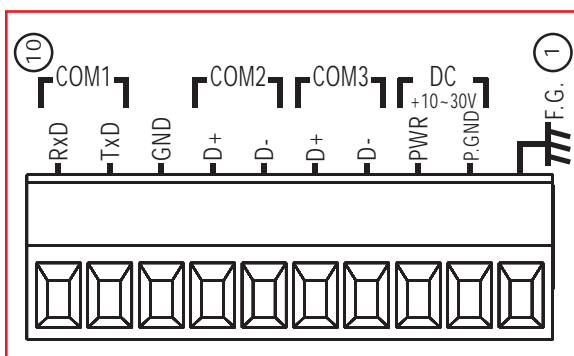
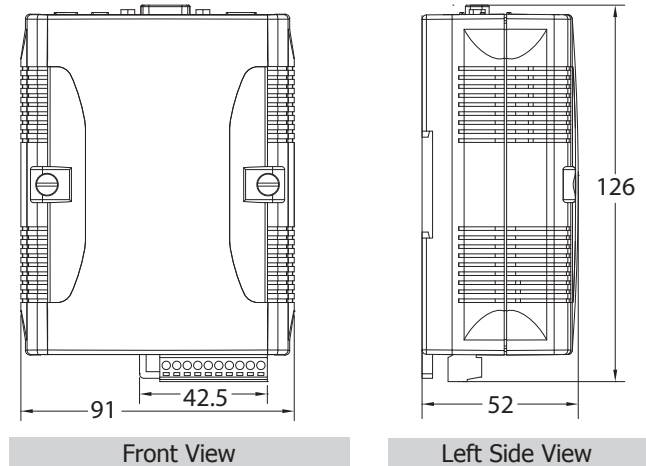

**Ordering Information**

<b>PMC-5151-EN CR</b>	Power Meter Concentrator (English)(RoHS)
-----------------------	--

**Accessories**

MDR-20-24 CR	24 VDC/1.0 A, 24 W Power Supply with DIN-Rail Mounting (RoHS)
GTM-203M-3GWA	Industrial Quad-band 3G WCDMA modem (RoHS)

# Power Meter Concentrator With Display



## Features

- Provide 7"/10.4" Touch Panel for On-Site operations
- Provide remote connection using browsers to login for operations
- Support up to 24 ICP DAS Modbus Power Meter and 8 Modbus I/O (COM2, COM3 and LAN interface can connect to Max. 16 power meters.)
- Provide real-time/historical power data statistics report
- Provide microSD card to store power data information
- Data file auto send-back & recovery when disconnected network is resumed
- Built-in IF-THEN-ELSE logic engine for power demand management
- Provide alarm message notification function via Email
- Adjust device operations by its power status via Modbus I/O modules
- Provide Schedule function for operations of I/O modules (devices)
- Support Modbus TCP/RTU Slave protocol for integration with SCADA
- Support SNMP Protocol



## Introduction

The PMD is a web-based intelligent Power Meter Concentrator with Display. It offers webpage interface, and features various functions such as: power data collection, logic control, power demand management, data logger, local display/Web page data display and alarm notification functions. PMD allows connections to ICP DAS Smart Power Meters via RS-485 or Ethernet interface to read and record the power data of the devices measured by the power meters. PMD also provides data logger file auto send-back function; together with PMC Data Server software or SCADA software, it allows collection and analysis of the power data.

PMD is equipped with 7"/10.4" TFT LCD (with Touch Panel). It provides an easy way for viewing the power data and setting the system parameters on sites. In addition, it can also access built-in Web Server on the PMD via browsers for the above operations. PMD also offers Modbus TCP/RTU Slave function that allows seamless integration with most SCADA software.

## Applications

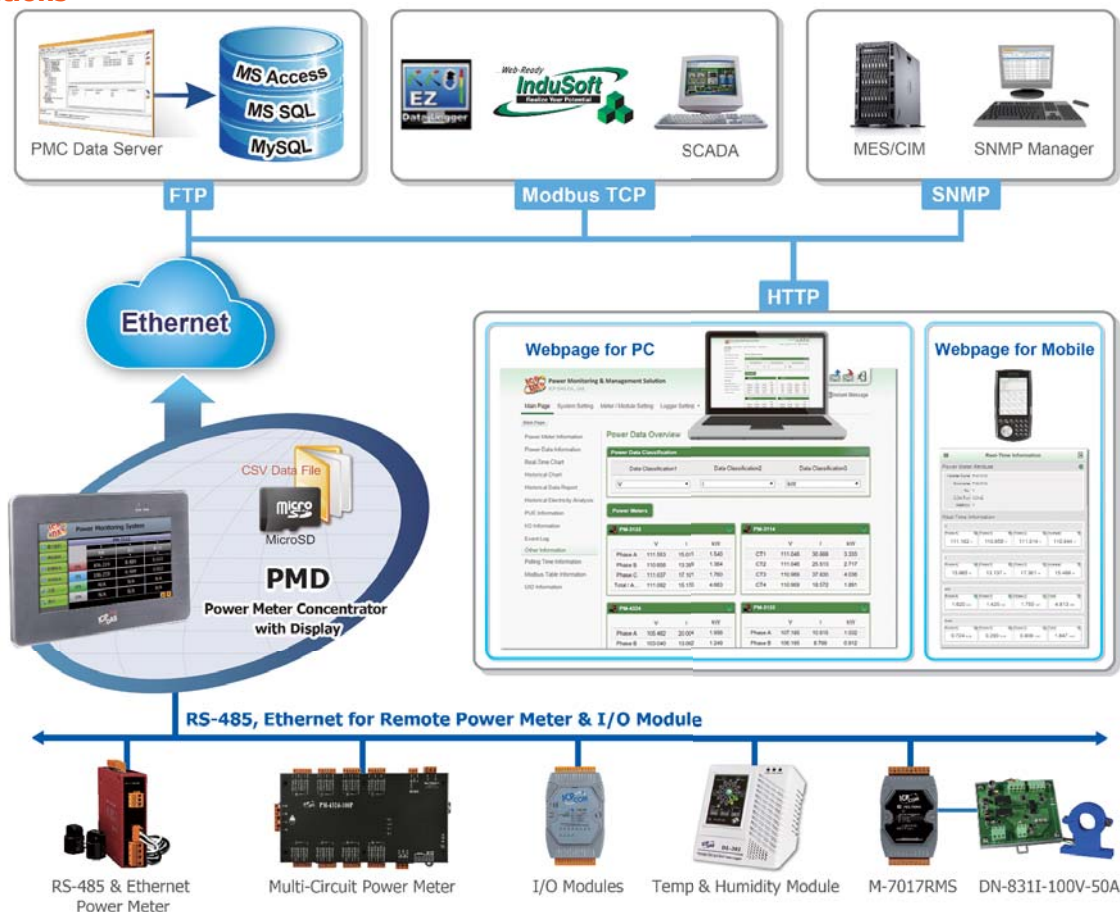



In addition to ICP DAS M-7000 I/O modules, the PMD could connect to standard Modbus TCP/RTU Slave modules. By working with the I/O modules, and functions such as IF-THEN-ELSE logic rule execution and alarm notification functions including Email/SNMP Trap, PMD offers more thought-out power demand management and alarm notification functions, and is able to perform load shedding of the devices if required, and enables real-time monitoring and control of the power consumption of the devices.

**Specifications**

Model	PMD-2201	PMD-4201
<b>System</b>		
Embedded Service	PMC Runtime, Web server and FTP server	
Memory Expansion	microSD socket with 4 GB micro SDHC card (support up to 32 GB)	SD socket with 4 GB SDHC card (support up to 32 GB)
<b>LCD</b>		
Diagonal Size	7" (16:9)	10.4" (4:3)
Resolution	800 x 480	800 x 600
Brightness (cd/m <sup>2</sup> )	400	
Contrast Ratio	500:1	
LED Backlight Life (hrs)	20,000	50,000
Touch Panel	4-wire, resistive type; light transmission: 80%	5-wire, resistive type; light transmission: 80%
<b>Communication Ports</b>		
Ethernet	1 x RJ-45 10/100/1000 Base-TX	
USB 2.0 (host)	2	
COM 1	RS-485 (Data+, Data-) (9-wire DB9 connector); 2500 VDC isolated	
COM 2	RS-485 (Data+, Data-) (9-wire DB9 connector); 2500 VDC isolated	
COM 3	-	RS-485 (Data+, Data-, GND); 2500 VDC isolated
<b>Mechanical</b>		
Dimensions (W x H x D)	213 mm x 148 mm x 44 mm	291 mm x 229 mm x 54 mm
Panel Cut-Out (W x H)	200 mm x 133 mm, +/- 1 mm	276 mm x 214 mm, +/- 1 mm
Installation	Panel Mounting; VESA (75 x 75) Mounting	Panel Mounting; VESA (75 x 75, 100 x 100) Mounting
Ingress Protection	Front panel: NEMA 4/IP65	
Weight	0.7 kg	1.8 kg
<b>Environmental</b>		
Operating Temperature	-10°C to +60°C	
<b>Power</b>		
Input Range	+12 VDC to +48 VDC	
Power from PoE	IEEE 802.3af	
Consumption	6 W	13W

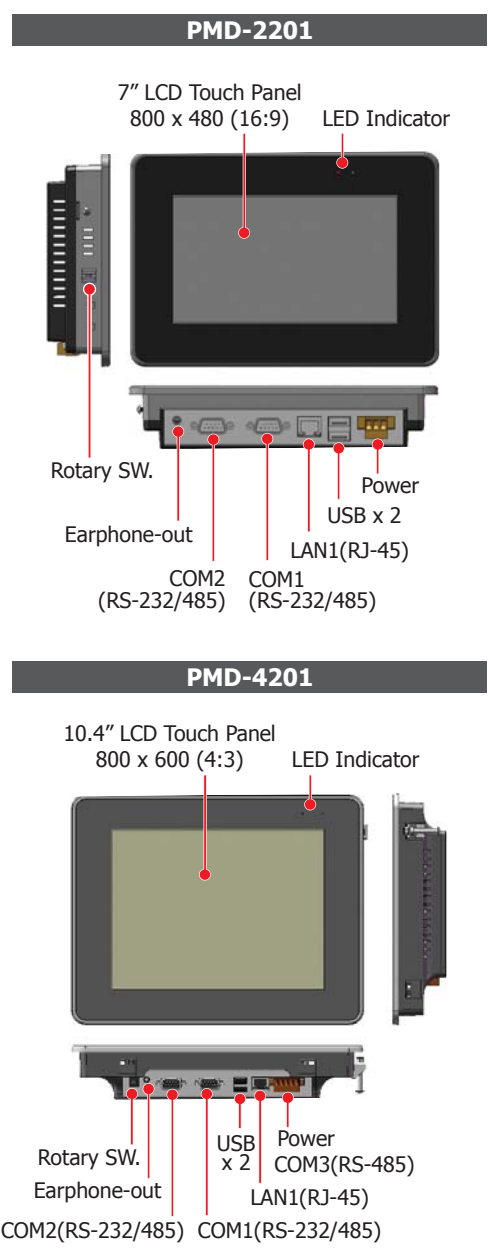

**Appearance**



**Ordering Information**

<b>PMD-2201-EN CR</b>	Power Meter Concentrator with 7" Display (English Version) (RoHS)
<b>PMD-4201-EN CR</b>	Power Meter Concentrator with 10.4" Display (English Version) (RoHS)

**Accessories**

MDR-60-24 CR	24 VDC/2.5 A, 60 W Power Supply with DIN-Rail Mounting (RoHS)
NS-205PSE CR	Unmanaged 5-port 10/100 Mbps PoE (PSE) Ethernet Switch (RoHS)
CA-090910-A 	9-pin Female D-sub cable, 1M
DN-09-2F 	I/O Connector Block with DIN-Rail Mounting and two 9-pin Male Header. Includes : CA-0910F x 2 (9-pin Female-Female D-sub Cable 1.0m)

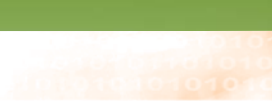

# Three-phase Smart Power Meter



**PM-3133/-MTCP/-CPS**

## Features

- True RMS Power Measurements
- Energy Analysis for 3P4W, 3P3W, 1P3W, 1P2W
- Current Measurements Up to 400 A with Different CT Ratio
- Voltage Measurements Up to 500 V
- Clip-on CT for Easy Installation
- W Accuracy Better than 0.5% (PF=1)
- Supports RS-485, Ethernet (PoE) or CANopen Interface
- Supports Modbus RTU, Modbus TCP or CANopen Protocol
- Supports 2 Power Relay Output (Form A)
- Total Harmonic Distortion (THD)
- IEC 61010-1 and EN 61010-1



## Introduction

ICP DAS brings the most powerful, cost-effective, advanced Smart Power Meters PM-3133 series that gives you access to real-time electric usage for three-phase power measurement. With its high accuracy ( $<0.5\%$ ,  $PF=1$ ), the PM-3133 series can be applied to both low voltage primary side and/or medium/high voltage secondary side and enables the users to obtain reliable and accurate energy consumption readings from the monitored equipments in real time under operation. These compact size and cost-effective power meters are equipped with revolutionary wired clip-on CT (various types, support input current up to 400 A). It operates over a wide input voltages range  $10 \sim 500$  VAC which allows worldwide compatibility. And with 2 channels relay outputs, it can be linked with sirens or lightings for alarm messages. It also supports Modbus RTU, Modbus TCP or CANopen protocols for easy integration. You can use CT's that you currently own with PM-3133P (without CTs) Power Meter. The CT inputs of the PM-3133P can handle a maximum of 333mV of AC current.

## Specifications

Models	PM-3133	PM-3133-MTCP	PM-3133-CPS
<b>AC Power Measurement</b>			
Wiring	3P4W-3CT, 3P3W-2CT, 3P3W-3CT, 1P2W-1CT, 1P3W-2CT		
Measurement Voltage	10 ~ 500 V		
Measurement Current	CT $\varnothing$ 10 mm (60 A); CT $\varnothing$ 16 mm (100 A); CT $\varnothing$ 24 mm (200 A); CT $\varnothing$ 36 mm (300 A); CT $\varnothing$ 36 mm (400 A)		
Measurement Frequency	50/60 Hz		
W Accuracy	Better than 0.5% (PF=1)		
Power Parameter Measurement	True RMS voltage ( $V_{rms}$ ), True RMS current ( $I_{rms}$ ), Active Power (kW), Active Energy (kWh), Apparent Power (kVA), Apparent Energy (kVAh), Reactive Power (kVAR), Reactive Energy (kVARh), Power Factor (PF), Frequency		
Data Update Rate	1 Second		
<b>Communication</b>			
RS-485	Protocol	Modbus-RTU	-
	Baud rate	9600,19200 (default), 38400, 115200; DIP Switch Selectable	-
	Data format	N,8,1	-
	Isolation	3000 VDC	-
Ethernet (PoE)	Protocol	-	Modbus TCP
	Protocol	-	-
CANopen	Protocol	-	CANopen
	Baud rate	-	125 k (default), 250 k, 500 k, 1 M; DIP Switch Selectable
	Isolation	-	3000 VDC
<b>Alarm Output</b>			
Power Relay	Form A (Normal Open) x 2; Relay Contact Voltage Range: 5 A @ 250 VAC (47 ~ 63Hz), 5 A @ 30 VDC		
<b>Power</b>			
Power Input	+12 ~ 48 VDC	+12 ~ 48 VDC or PoE	+12 ~ 48 VDC
Power Consumption	2 W		
<b>Environment</b>			
Temperature	Operating Temperature: -20 ~ +70 °C / Storage Temperature: -25 ~ +80 °C		
Ambient Relative Humidity	10% ~ 90% RH, Non-condensing		

Appearance

LED indicators

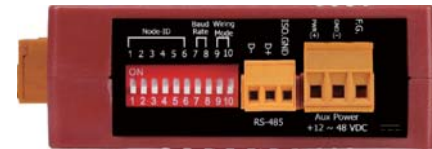
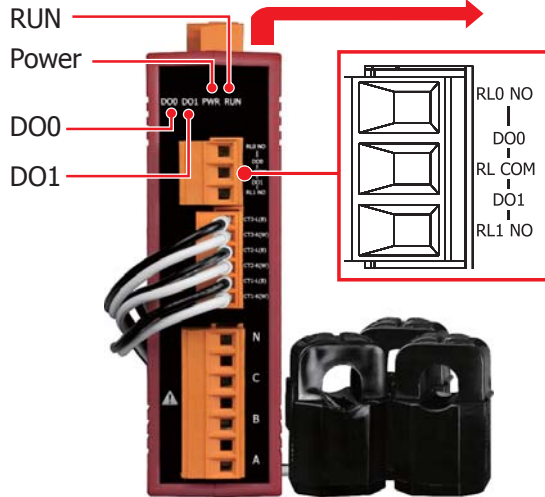

RS-485 Interface



CANopen Interface



Ethernet Interface

Dimensions (Units: mm)

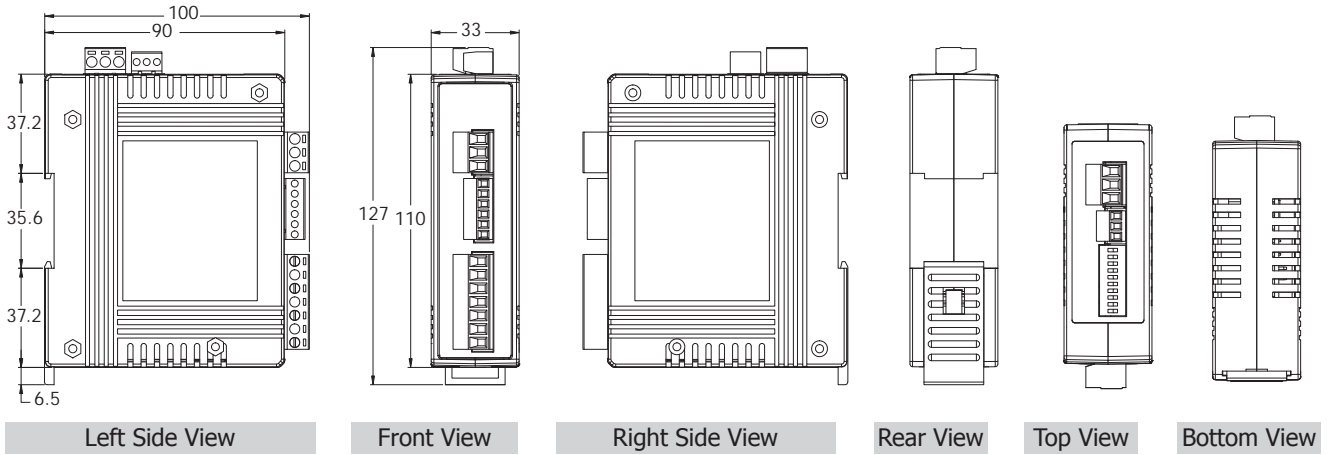

Selection Guide



**CT size (measurement)**  
 100: CTΦ10 mm, 60 A Max.  
 160: CTΦ16 mm, 100 A Max.  
 240: CTΦ24 mm, 200 A Max.  
 360P: CTΦ36 mm, 300 A Max.  
 400P: CTΦ36 mm, 400 A Max.

**Current Transformers (Secondary voltage 333mV)**

**Communication**  
 □: RS-485  
 □: CANopen  
 □: Modbus TCP

Ordering Information

RS-485 Interface	
PM-3133P	Modbus RTU, 3-phase power meter (Compatible with CTs from 50 to 1000 A/333 mV output)
PM-3133-100	Modbus RTU, 3-phase power meter (60 A)
PM-3133-160	Modbus RTU, 3-phase power meter (100 A)
PM-3133-240	Modbus RTU, 3-phase power meter (200 A)
PM-3133-360P	Modbus RTU, 3-phase power meter (300 A)
PM-3133-400P	Modbus RTU, 3-phase power meter (400 A)

Ethernet Interface		CANopen Interface	
PM-3133-100-MTCP	Modbus TCP, 3-phase power meter (60 A)	PM-3133-100-CPS	CANopen, 3-phase power meter (60 A)
PM-3133-160-MTCP	Modbus TCP, 3-phase power meter (100 A)	PM-3133-160-CPS	CANopen, 3-phase power meter (100 A)
PM-3133-240-MTCP	Modbus TCP, 3-phase power meter (200 A)	PM-3133-240-CPS	CANopen, 3-phase power meter (200 A)
PM-3133-360P-MTCP	Modbus TCP, 3-phase power meter (300 A)	PM-3133-360P-CPS	CANopen, 3-phase power meter (300 A)
PM-3133-400P-MTCP	Modbus TCP, 3-phase power meter (400 A)	PM-3133-400P-CPS	CANopen, 3-phase power meter (400 A)

# Three-phase Smart Power Meter



## Features

- True RMS Power Measurements
- Energy Analysis for 3P4W, 3P3W, 1P3W, 1P2W
- Direct input of secondary side 1A/5A CT
- Voltage Measurements Up to 500 V
- W Accuracy Better than 0.5% (PF=1)
- Supports RS-485, Ethernet (PoE) or CANopen Interface
- Supports Modbus RTU/Modbus TCP or CANopen Protocol
- Total Harmonic Distortion (THD)
- IEC 61010-1 and EN 61010-1



## Introduction

ICP DAS brings the most powerful, cost-effective, advanced Smart Power Meters PM-3033 series that gives you access to real-time electric usage for three-phase power measurement. With its high accuracy ( $<0.5\%$ ,  $PF=1$ ), the PM-3033 series can be applied to both low voltage primary side and/or medium/high voltage secondary side and enables the users to obtain reliable and accurate energy consumption readings from the monitored equipments in real time under operation.

Direct input from "secondary side 1A/5A" type CTs. Dedicated CTs are no longer needed, which lowers the cost of implementation. It operates over a wide input voltages range  $10 \sim 500$  VAC which allows worldwide compatibility. It also supports Modbus RTU, Modbus TCP or CANopen protocols for easy integration.

## Specifications

Models		PM-3033	PM-3033-MTCP	PM-3033-CPS
<b>AC Power Measurement</b>				
Wiring		3P4W-3CT, 3P3W-2CT, 3P3W-3CT, 1P2W-1CT, 1P3W-2CT		
Measurement Voltage		10 ~ 500 V		
Measurement Current		1A or 5A		
Measurement Frequency		50/60 Hz		
W Accuracy		Better than 0.5% (PF=1)		
Power Parameter Measurement		True RMS voltage (Vrms), True RMS current (Irms), Active Power (kW), Active Energy (kWh), Apparent Power (kVA), Apparent Energy (kVAh), Reactive Power (kVAR), Reactive Energy (kVARh), Power Factor (PF), Frequency		
Data Update Rate		1 Second		
<b>Communication</b>				
RS-485	Protocol	Modbus-RTU	-	-
	Baud rate	9600,19200 (default), 38400, 115200; DIP Switch Selectable	-	-
	Data format	N,8,1 (default); N,8,2; E,8,1; E,8,2; O,8,1; O,8,2	-	-
	Isolation	3000 VDC	-	-
Ethernet (PoE)	Protocol	-	Modbus TCP	-
CANopen	Protocol	-	-	CANopen
	Baud rate	-	-	125 k (default), 250 k, 500 k, 1 M; DIP Switch Selectable
	Isolation	-	-	3000 VDC
<b>Power</b>				
Power Input		+12 ~ 48 VDC	+12 ~ 48 VDC or PoE	+12 ~ 48 VDC
Power Consumption		2 W		
<b>Environment</b>				
Temperature		Operating Temperature: $-20 \sim +70^{\circ}\text{C}$ / Storage Temperature: $-25 \sim +80^{\circ}\text{C}$		
Ambient Relative Humidity		10% ~ 90% RH, Non-condensing		

**CT Installation and Wiring**

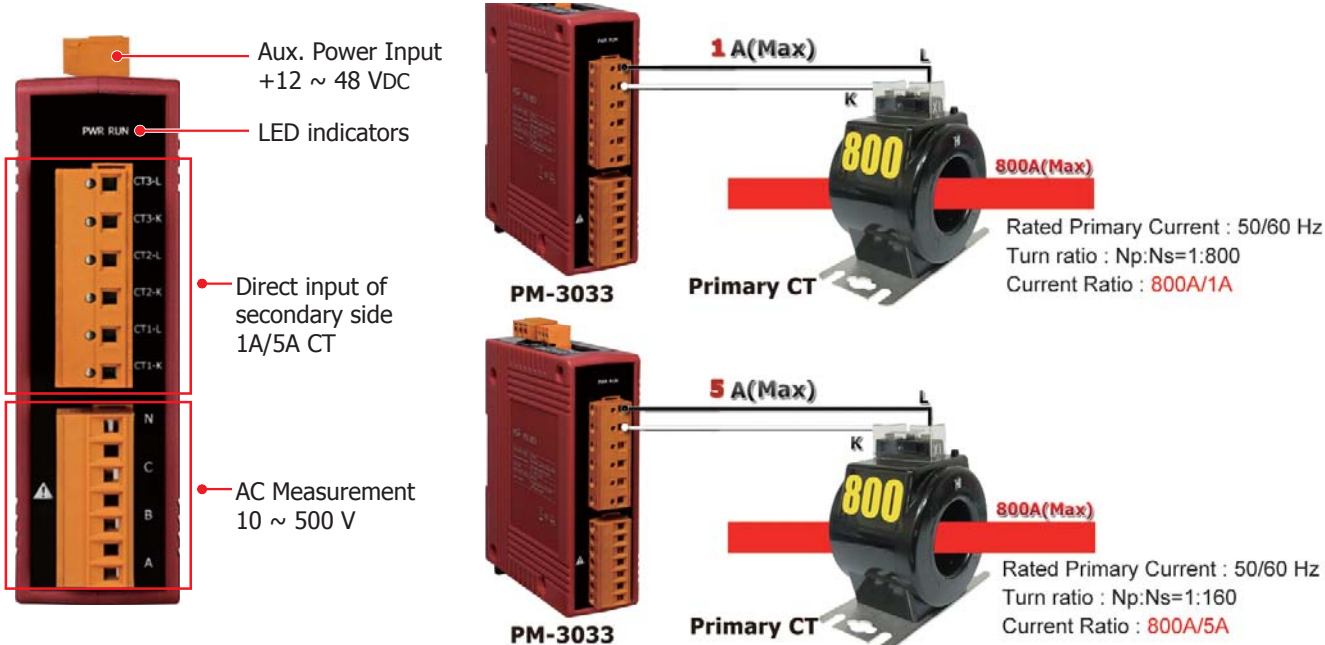

**Dimensions (Units: mm)**

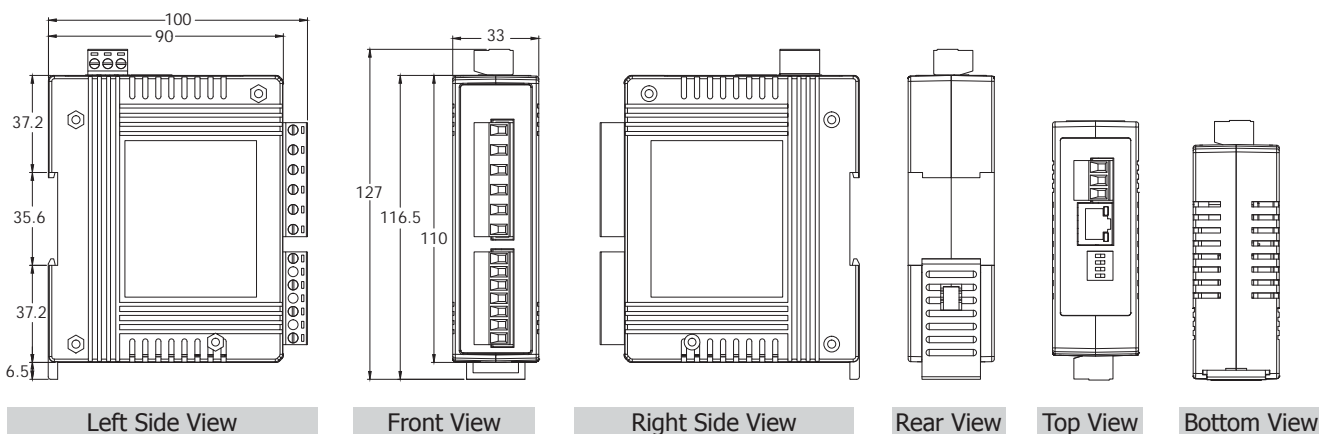

**Selection Guide**

**PM-3033 - [ X X X ]**

Communication  
 RS-485  
 CPS: CANopen  
 MTCP: Modbus TCP

**Ordering Information**

<b>RS-485 Interface</b>	
<b>PM-3033</b>	Modbus RTU, 3-phase power meter (1A/5A CT Input type)
<b>Ethernet Interface</b>	
<b>PM-3033-MTCP</b>	Modbus TCP, 3-phase power meter (1A/5A CT Input type)
<b>CANopen Interface</b>	
<b>PM-3033-CPS</b>	CANopen, 3-phase power meter (1A/5A CT Input type)

# Single-phase Smart Power Meter



## Features

- True RMS Power Measurements
- Energy Analysis for 1P2W, 1P4W
- Current Measurements Up to 200 A with Different CT Ratio
- Voltage Measurements Up to 300 V
- Clip-on CT for Easy Installation
- W Accuracy Better than 0.5% (PF=1)
- Supports RS-485, Ethernet or CANopen Interface
- Supports Modbus RTU, Modbus TCP or CANopen Protocol
- Supports 2 Power Relay Output (Form A)
- IEC 61010-1 and EN 61010-1



## Introduction

ICP DAS brings the most powerful, cost-effective, advanced Smart Power Meters PM-3000 series that gives you access to real-time electric usage for single-phase power measurement. With its high accuracy ( $< 0.5\%$ ,  $PF=1$ ), the PM-3000 series can be applied to both low voltage primary side and/or medium/high voltage secondary side and enables the users to obtain reliable and accurate energy consumption readings from the monitored equipments in real time under operation. These compact size and cost-effective power meters are equipped with revolutionary wired clip-on CT (various types, support input current up to 200 A). It operates over a wide input voltages range  $10 \sim 300$  VAC which allows worldwide compatibility. And with 2 channels relay outputs, it can be linked with sirens or lightings for alarm messages. It also supports Modbus RTU, Modbus TCP or CANopen protocols for easy integration.

## Specifications

Models	PM-3112	PM-3114	PM-3112-MTCP	PM-3114-MTCP	PM-3112-CPS	PM-3114-CPS
<b>AC Power Measurement</b>						
Wiring	1P2W-2CT	1P4W-4CT	1P2W-2CT	1P4W-4CT	1P2W-2CT	1P4W-4CT
Input Voltage	10 ~ 300 V					
Input Current	CTØ10 mm (60 A); CTØ16 mm (100 A); CTØ24 mm (200 A)					
Input Frequency	50/60 Hz					
W Accuracy	Better than 0.5% (PF=1)					
Starting Current	$>0.03A$ (60A), $>0.05A$ (100A), $>0.09A$ (200A)					
Power Parameter Measurement	True RMS voltage (Vrms), True RMS current (Irms), Active Power (kW), Active Energy (kWh), Apparent Power (kVA), Apparent Energy (kVAh), Reactive Power (kVAR), Reactive Energy (kVARh), Power Factor (PF), Frequency					
Data Update Rate	1 Second					
<b>Communication</b>						
RS-485	Protocol	Modbus-RTU	-	-	-	-
	Baud rate	9600,19200 (default), 38400, 115200; DIP Switch Selectable	-	-	-	-
	Data format	N,8,1	-	-	-	-
	Isolation	3000 VDC	-	-	-	-
Ethernet	Protocol	-	Modbus TCP	-	-	-
CANopen	Protocol	-	-	-	CANopen	
	Baud rate	-	-	-	125 k (default), 250 k, 500 k, 1 M; DIP Switch Selectable	
<b>Alarm Output</b>						
Power Relay	Form A (Normal Open) x 2; Relay Contact Voltage Range: 5 A @ 250 VAC (47 ~ 63Hz), 5 A @ 30 VDC					
<b>Power</b>						
Input Range	+12 ~ 48 VDC	+12 ~ 48 VDC	+12 ~ 48 VDC	+12 ~ 48 VDC	+12 ~ 48 VDC	+12 ~ 48 VDC
Power Consumption	2 W					
<b>Environment</b>						
Temperature	Operating Temperature: $-20 \sim +70^{\circ}C$ / Storage Temperature: $-25 \sim +80^{\circ}C$					
Ambient Relative Humidity	10% ~ 90% RH, Non-condensing					

Appearance

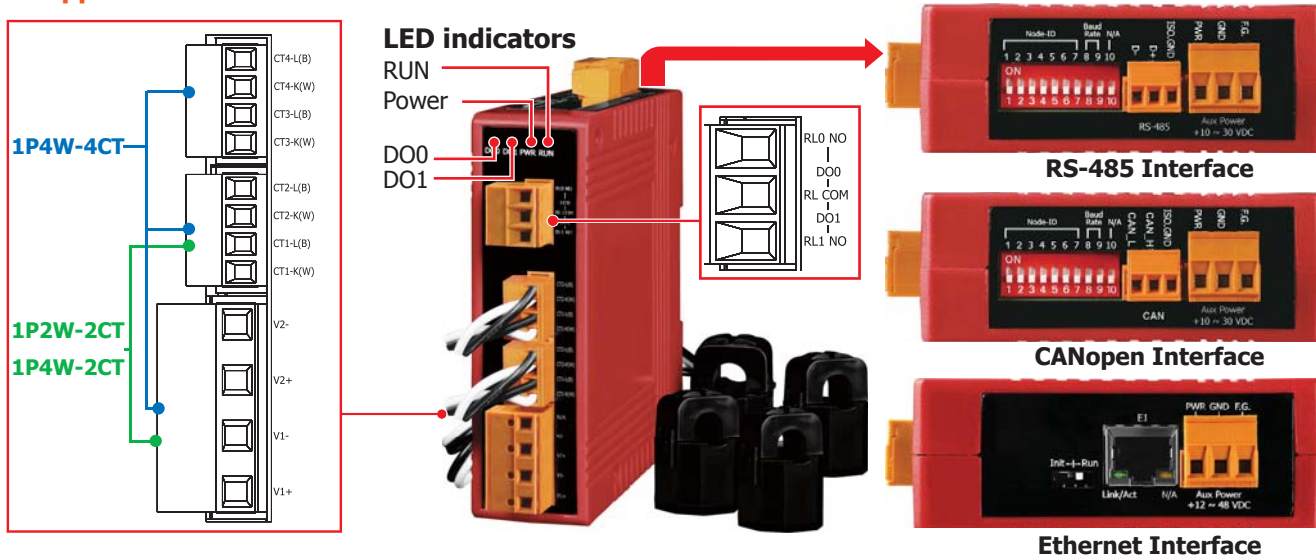

Dimensions (Units: mm)

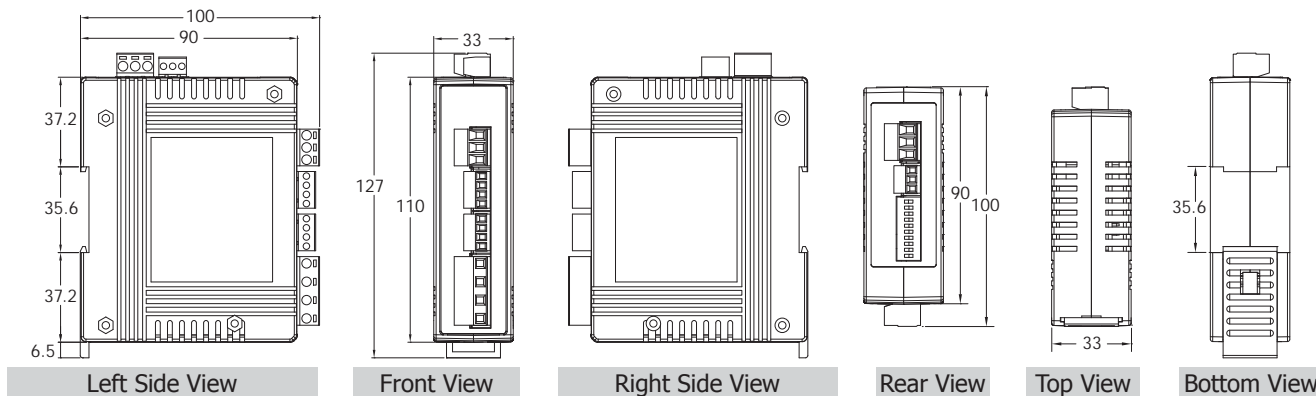

Selection Guide

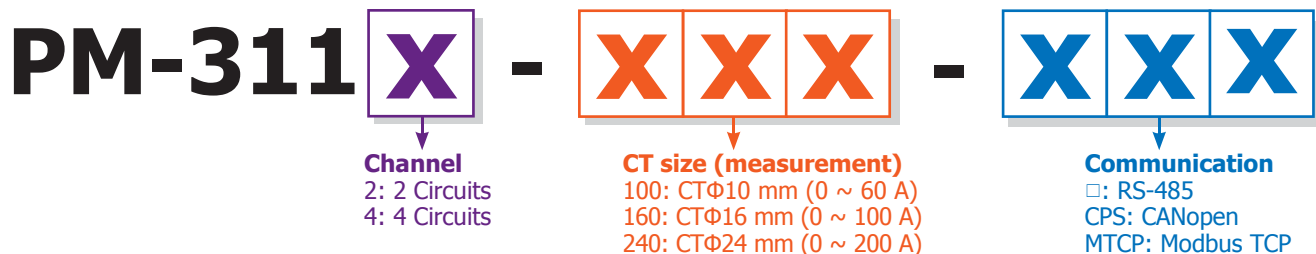

Ordering Information

RS-485 Interface	
PM-3112-100	Modbus RTU, 2 single-phase circuits Power Meter with 2 CTs (60 A)
PM-3112-160	Modbus RTU, 2 single-phase circuits Power Meter with 2 CTs (100 A)
PM-3112-240	Modbus RTU, 2 single-phase circuits Power Meter with 2 CTs (200 A)
Ethernet Interface	
PM-3112-100-MTCP	Modbus TCP, 2 single-phase circuits Power Meter with 2 CTs (60 A)
PM-3112-160-MTCP	Modbus TCP, 2 single-phase circuits Power Meter with 2 CTs (100 A)
PM-3112-240-MTCP	Modbus TCP, 2 single-phase circuits Power Meter with 2 CTs (200 A)
CANopen Interface	
PM-3112-100-CPS	CANOpen, 2 single-phase circuits Power Meter with 2 CTs (60 A)
PM-3112-160-CPS	CANOpen, 2 single-phase circuits Power Meter with 2 CTs (100 A)
PM-3112-240-CPS	CANOpen, 2 single-phase circuits Power Meter with 2 CTs (200 A)

RS-485 Interface	
PM-3114-100	Modbus RTU, 4 single-phase circuits power meter (60 A)
PM-3114-160	Modbus RTU, 4 single-phase circuits power meter (100 A)
PM-3114-240	Modbus RTU, 4 single-phase circuits power meter (200 A)
Ethernet Interface	
PM-3114-100-MTCP	Modbus TCP, 4 single-phase circuits power meter (60 A)
PM-3114-160-MTCP	Modbus TCP, 4 single-phase circuits power meter (100 A)
PM-3114-240-MTCP	Modbus TCP, 4 single-phase circuits power meter (200 A)
CANopen Interface	
PM-3114-100-CPS	CANOpen, 4 single-phase circuits power meter (60 A)
PM-3114-160-CPS	CANOpen, 4 single-phase circuits power meter (100 A)
PM-3114-240-CPS	CANOpen, 4 single-phase circuits power meter (200 A)

# Multi-circuit Smart Power Meter

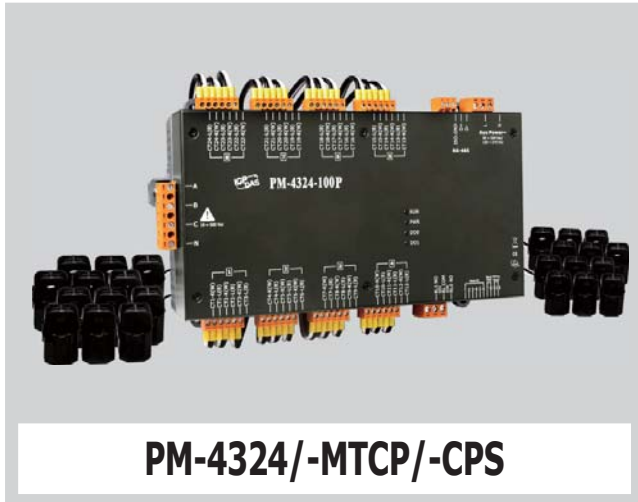

**PM-4324/-MTCP/-CPS**

## Features

- 8 Three Phase Circuits or 24 Single Phase Circuits
- True RMS Power Measurements
- Energy Analysis for 3P4W, 3P3W, 1P3W, 1P2W
- Current Measurements Up to 400 A with Different CT Ratio
- Voltage Measurements Up to 500 V
- Split Core CT for Easy Installation
- W Accuracy Better than 0.5% (PF=1)
- Supports RS-485, Ethernet or CAN bus Interface
- Supports Modbus RTU, Modbus TCP or CANopen Protocol
- Supports 2 Power Relay Output (Form A)
- Total Harmonic Distortion (THD)



## Introduction

The **PM-4324** Multi-circuit Power Meter monitors up to 8 three phase circuits or 24 single phase circuits, or any combination of single or three phase circuits. The PM-4324 can measure up to 24 currents via external Current Transformers (CTs). This flexibility makes the PM-4324 perfect for multi-tenant facilities such as residential projects, office buildings and shopping malls. This compact instrument is designed to easily fit into existing panel boards or be flush mounted nearby, thus eliminating the need for expensive retrofit projects or for allocating extra space for the device.

## Specifications

Models	PM-4324	PM-4324-MTCP	PM-4324-CPS
<b>AC Power Measurement</b>			
Wiring	3P4W-3CT, 3P3W-2CT, 3P3W-3CT, 1P2W-1CT, 1P3W-2CT		
Measurement Voltage	10 ~ 500 V		
Measurement Current	CTØ10 mm (60 A); CTØ16 mm (100 A); CTØ24 mm (200 A); CTØ36 mm (300 A); CTØ36 mm (400 A)		
Measurement Frequency	50/60 Hz		
W Accuracy	Better than 0.5% (PF=1)		
Power Parameter Measurement	True RMS voltage (Vrms), True RMS current (Irms), Active Power (kW), Active Energy (kWh), Apparent Power (kVA), Apparent Energy (kVAh), Reactive Power (kVAR), Reactive Energy (kVARh), Power Factor (PF), Frequency		
Data Update Rate	1 Second		
<b>Communication</b>			
RS-485	Protocol	Modbus-RTU	-
	Baud rate	9600,19200 (default), 38400, 115200; DIP Switch Selectable	-
	Data format	N,8,1; N,8,2; E,8,1; E,8,2; O,8,1; O,8,2	-
	Isolation	3000 VDC	-
Ethernet	Protocol	-	Modbus TCP
CAN Bus	Protocol	-	CANopen
	Baud rate	-	125 k (default), 250 k, 500 k, 1 M; DIP Switch Selectable
	Isolation	-	3000 VDC
<b>Alarm Output</b>			
Power Relay	Form A (Normal Open) x 2; Relay Contact Voltage Range: 5 A @ 250 VAC (47 ~ 63 Hz), 5 A @ 30 VDC		
<b>Power</b>			
Input Range	+85 ~ +264 VAC		
Power Consumption	6 W		
<b>Mechanical</b>			
Dimensions / Casing	237 mm x 52 mm x 134 mm (W x L x H) / Plastic		
Module Installation	DIN-Rail Mounting		
<b>Environment</b>			
Temperature	Operating Temperature: -20 ~ +70°C / Storage Temperature: -25 ~ +80°C		
Ambient Relative Humidity	10% ~ 90% RH, Non-condensing		



Appearance

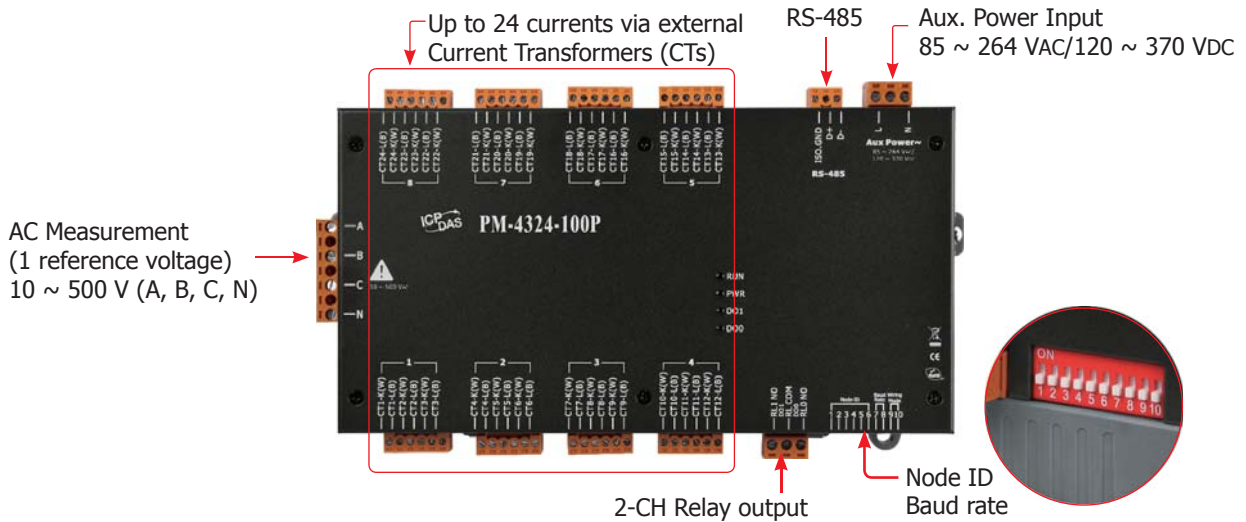

Dimensions (Units: mm)

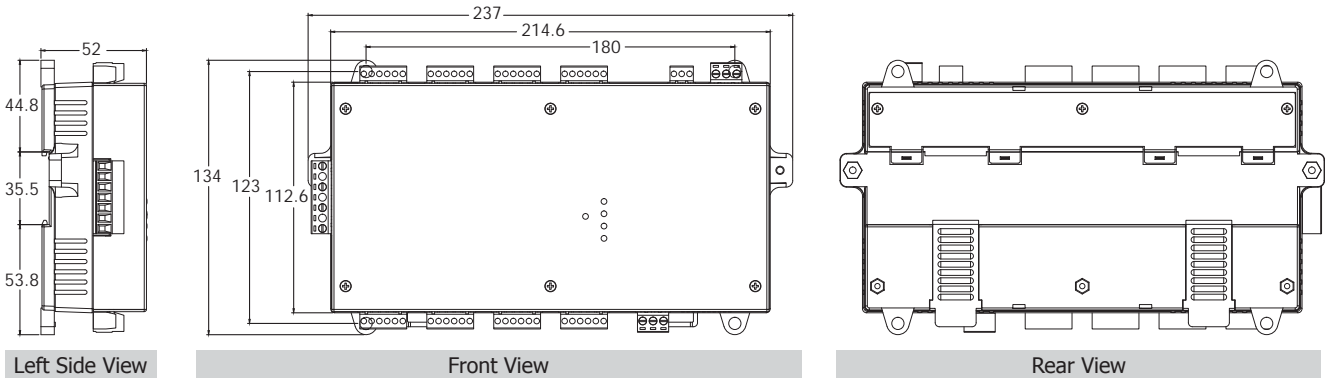

Selection Guide

**PM-4324-** **X X X P** - **X X X**

**CT size (measurement)**  
 100P: CTΦ10 mm, 60 A Max.  
 160P: CTΦ16 mm, 100 A Max.  
 240P: CTΦ24 mm, 200 A Max.  
 360P: CTΦ36 mm, 300 A Max.  
 400P: CTΦ36 mm, 400 A Max.

**Current Transformers (Secondary voltage 333mV)**

**Communication**  
 □: RS-485  
 CPS: CANopen  
 MTCP: Modbus TCP

Ordering Information

RS-485 Interface		Ethernet Interface	
<b>PM-4324P</b>	Modbus RTU, Multi-Circuit Power Meter (Can be directly input from the secondary side of 333mV CT)	<b>PM-4324-100P-MTCP</b>	Modbus TCP, Multi-Circuit Power Meter (60 A)
<b>PM-4324-100P</b>	Modbus RTU, Multi-Circuit Power Meter (60 A)	<b>PM-4324-160P-MTCP</b>	Modbus TCP, Multi-Circuit Power Meter (100 A)
<b>PM-4324-160P</b>	Modbus RTU, Multi-Circuit Power Meter (100 A)	<b>PM-4324-240P-MTCP</b>	Modbus TCP, Multi-Circuit Power Meter (200 A)
<b>PM-4324-240P</b>	Modbus RTU, Multi-Circuit Power Meter (200 A)	<b>PM-4324-360P-MTCP</b>	Modbus TCP, Multi-Circuit Power Meter (300 A)
<b>PM-4324-360P</b>	Modbus RTU, Multi-Circuit Power Meter (300 A)	<b>PM-4324-400P-MTCP</b>	Modbus TCP, Multi-Circuit Power Meter (400 A)
<b>PM-4324-400P</b>	Modbus RTU, Multi-Circuit Power Meter (400 A)	<b>CANopen Interface</b>	
		<b>PM-4324-100P-CPS</b>	CANOpen, Multi-Circuit Power Meter (60 A)
		<b>PM-4324-160P-CPS</b>	CANOpen, Multi-Circuit Power Meter (100 A)
		<b>PM-4324-240P-CPS</b>	CANOpen, Multi-Circuit Power Meter (200 A)
		<b>PM-4324-360P-CPS</b>	CANOpen, Multi-Circuit Power Meter (300 A)
		<b>PM-4324-400P-CPS</b>	CANOpen, Multi-Circuit Power Meter (400 A)

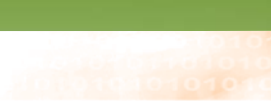

## CT for Smart Power Meter

### ■ Dimensions (Units: mm)

**100: CTΦ10mm (60 A Max.)**

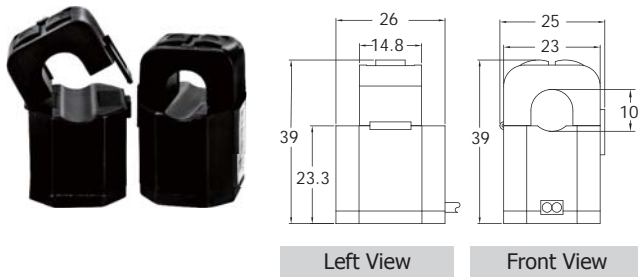

**360P: CTΦ36mm (300 A Max.)**

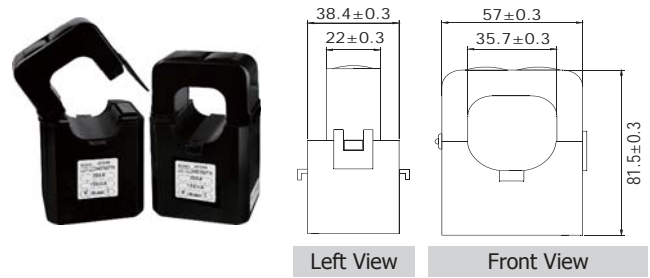

**160: CTΦ16mm (100 A Max.)**

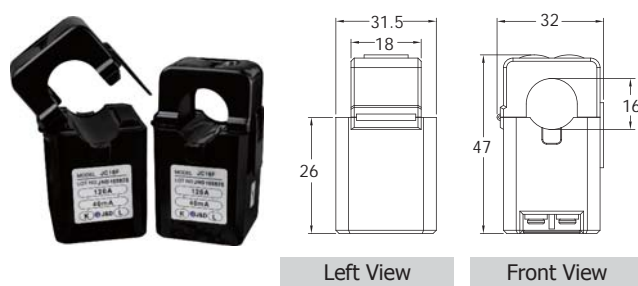

**400P: CTΦ36mm (400 A Max.)**

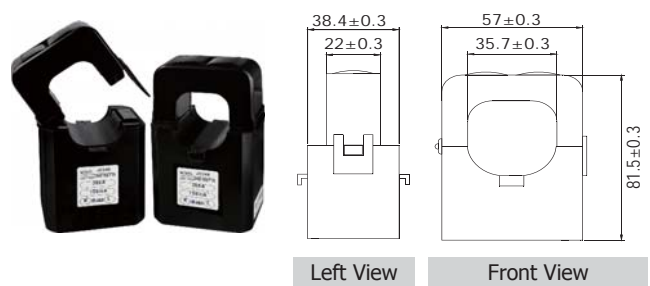

**240: CTΦ24mm (200 A Max.)**

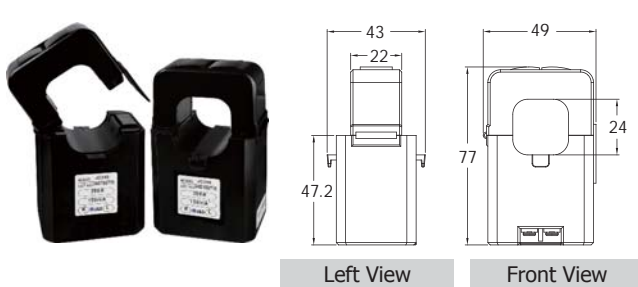

**RCT1000P: CTΦ800mm (1000 A Max.)**



### ■ Installation

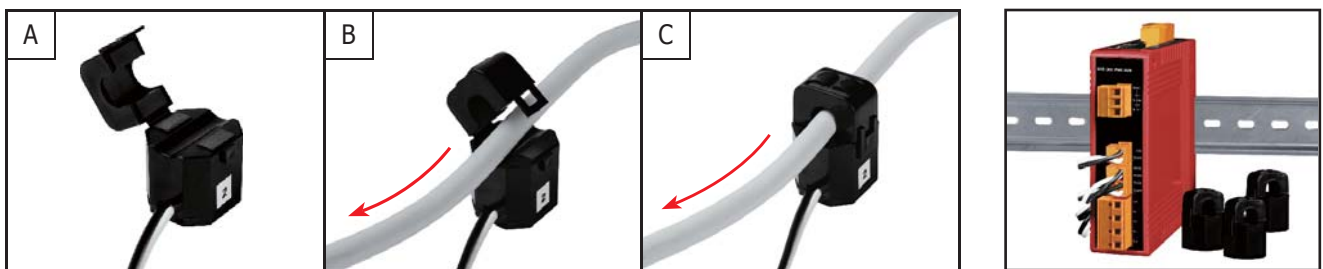

Clip-on CT Installation

DIN-Rail Mounting  
(EX: PM-3133)

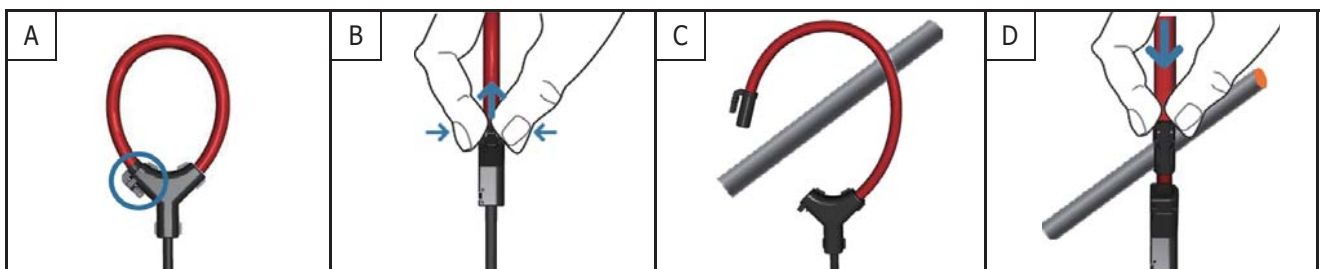

Rogowski coil Soft CT Installation

# 8-channel True RMS Input Module



## M-7017RMS

### Introduction

The **M-7017RMS** is an 8-channel differential AC input module that is used to convert the AC input signals to their True RMS DC values. The RMS input range can be from +150 mVrms to +10 Vrms, and each channel can be configured individually. The M-7017RMS is a complete, high-accuracy, RMS-to-DC converter that computes the True RMS DC value of any complex waveform. It also features 4 kV ESD protection, 2500 VDC intra-module isolation and +/-35 VDC overvoltage protection.

### System Specifications

Communication	
Interface	RS-485
Bias Resistor	No (Usually supplied by the RS-485 Master. Or, add a tM-SG4 or SG-785.)
Baud Rate	1200 to 115200 bps
Protocol	Modbus RTU, DCON
Dual Watchdog	Yes, Module (1.6 Seconds), Communication (Programmable)
LED Indicators/Display	
System LED Indicator	1 as Power/Communication Indicator
Isolation	
Intra-module Isolation, Field-to-Logic	2500 VDC
EMS Protection	
ESD (IEC 61000-4-2)	±4 kV Contact for each Terminal ±8 kV Air for Random Point
EFT (IEC 61000-4-4)	±4 kV for Power Line
Surge (IEC 61000-4-5)	±0.5 kV for Power Line
Power	
Reverse Polarity Protection	Yes
Input	+10 ~ +30 VDC
Consumption	0.9 W
Mechanical	
Dimensions (L x W x H)	123 mm x 72 mm x 35 mm
Installation	DIN-Rail
Environment	
Operating Temperature	-25 to +75°C
Storage Temperature	-40 to +85°C
Humidity	10 to 95% RH, Non-condensing

### Features

- 8-channel True RMS Input
- ±0.15% Factory Calibrated Accuracy
- The RMS input range: +150 mVrms ~ +10 Vrms
- For Standard Operation with Frequencies: 45 Hz ~ 10 KHz
- Individual Channel Configurable



### Applications

- Building Automation
- Factory Automation
- Machine Automation
- Remote Maintenance
- Remote Diagnosis
- Testing Equipment

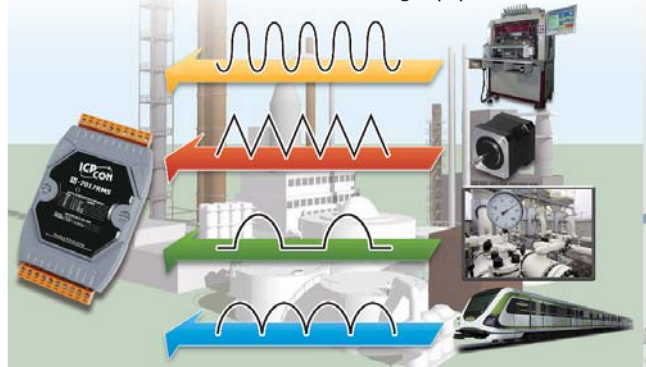

### I/O Specifications

Analog Input		
Channels	8	
Wiring	Differential	
Input Range	0 ~ +10 Vrms, 0 ~ +5 Vrms, 0 ~ +1 Vrms, 0 ~ +500 mVrms, 0 ~ +150 mVrms	
Resolution	16-bit	
Accuracy	Sinusoid	
	50/60 Hz	±0.15% of FSR
	45 Hz to 10 kHz	±0.5% of FSR
	Non-Sinusoid	
	Crest Factor = 1 to 2	±0.2% of FSR
	Crest Factor = 2 to 3	±0.35% of FSR
DC	0 ~ +10 Vrms/ 0 ~ +5 Vrms/ 0 ~ +1 Vrms,	±0.3% of FSR
	Other	±0.7% of FSR
	Sampling Rate	10 Hz (Total)
-3dB Bandwidth	15.7 Hz	
Zero Drift	±20 μV/°C	
Span Drift	±25 ppm/°C	
Common Mode Rejection	86 dB	
Normal Mode Rejection	100 dB	
Input Impedance	>2 MΩ	
Individual Channel Configuration	Yes	
Overvoltage Protection	±35 VDC	

**Internal I/O Structure**

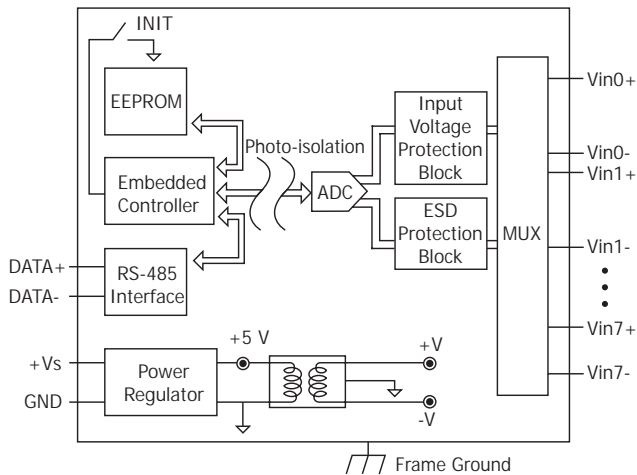

**Pin Assignments**

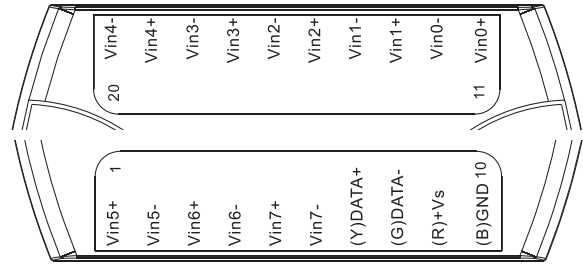

**Wire Connections**

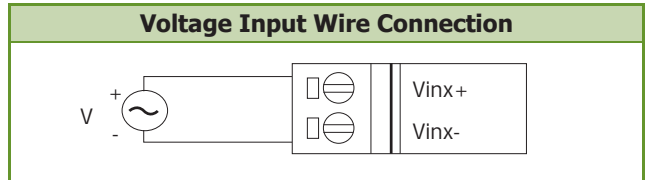

**Application**

There are five DC inverters on the machine. The loading of all inverters must be recorded during the manufacturing process for real-time and historical analysis. With the clip-on CT of DN-831I-100V, the power line wiring deployment does not require any modification. And with the software EZ Data Logger, the data logger can be done in 30 minutes.

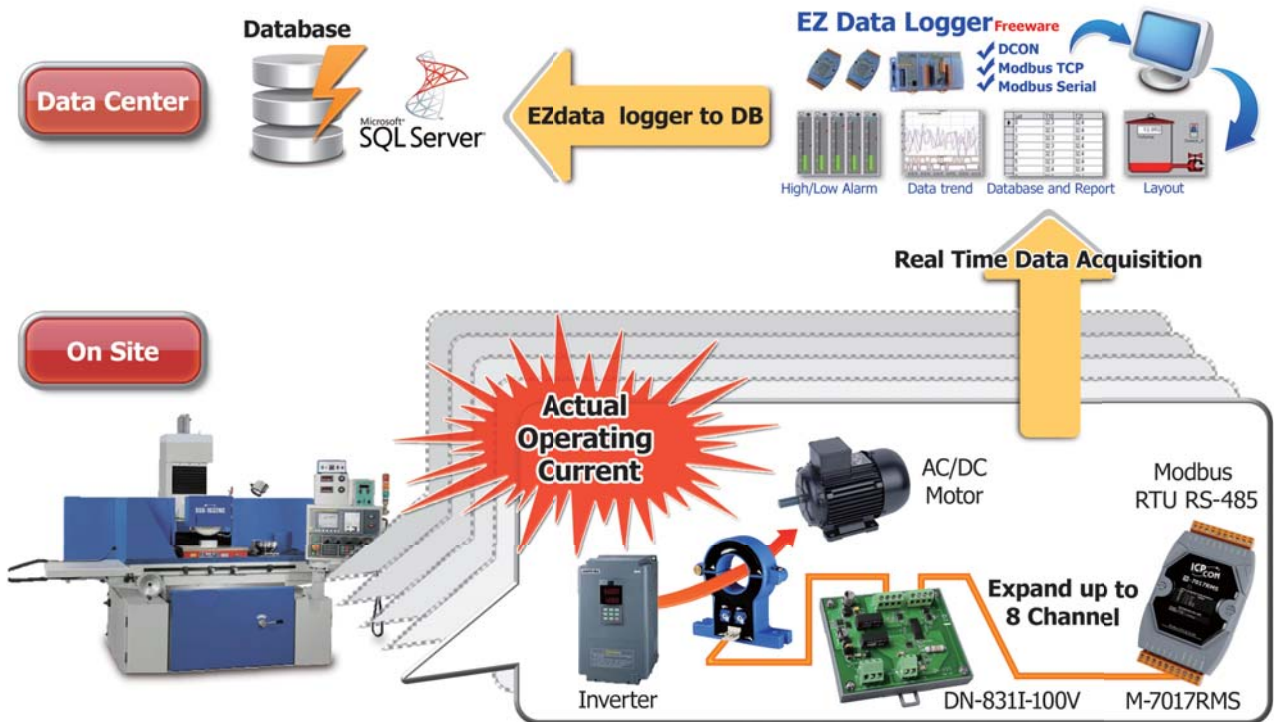

**Ordering Information**

<b>M-7017RMS-G CR</b>	8-channel True RMS Input Module (Gray Cover) (RoHS)
-----------------------	---

**Accessories**

SG-770 CR	7/14 channel Surge Protector (RoHS)	DN-800 Series	Voltage Attenuator and Current Transformer
SG-3000 Series	Signal Conditioning Modules for Thermocouple, RTD, DC Voltage, DC Current and Power Input Transformers		

## DN-800 Series Voltage Attenuator and Current Transformer

### Introduction

DN-800 series is a Voltage Attenuator and Current Transformer designed for used in high-voltage applications. The current can be converted into +/- 10 Vpp attenuated signal, so that a general electronic measuring device is able to read the signals. Compared to ICP DAS power meter products (PM-3033, PM-3133, PM-4324, etc.), in addition to AC signals, the DN-800 series can convert DC signals as well.

The users can use appropriate ICP DAS Remote I/O Modules such as: M-7017R, I-87017RW, or ET-7217 to measure the converted +/- 10 VDC signal via DN-800 series. And use M-7017RMS or I-87017W-RMS, etc. to measure the AC signals.

By using DN-800 series, the power data of all kinds of machines and AC/DC motors can be easily measured and retrieved, and then the analyzed data can be used to develop a model to build a failure warning system.

### Applications

The operating current of AC or DC motor of the machines is converted into +/- 10 Vpp attenuated signal via DN-844, and then the +/- 10 Vpp signal is converted based on Modbus / RTU protocol for seamless integration with all kinds of PLC or SCADA.

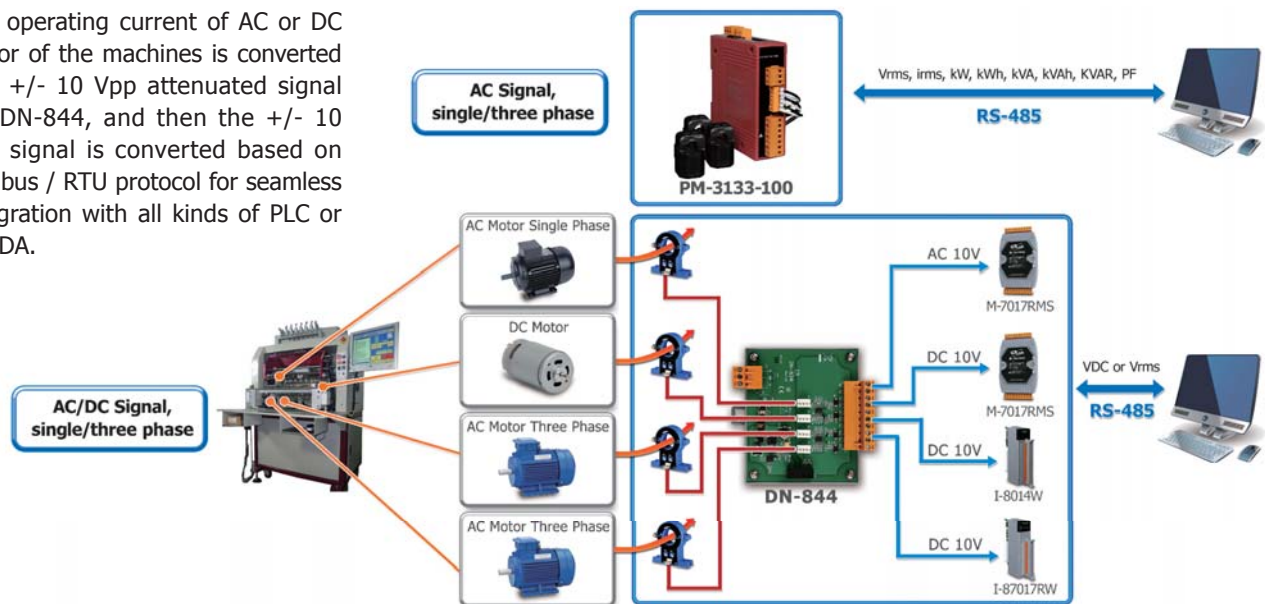

### Appearance and Specifications



DN-831I-100V-50A  
DN-831I-100V-200A  
DN-831I-100V-500A

DN-843VI-600V



DN-848VI-10V  
DN-848VI-80V  
DN-848VI-150V

DN-843I-CT-1  
DN-843I-CT-10  
DN-843I-CT-20  
DN-843I-CT-50



DN-844-50A  
DN-844-200A  
DN-844-500A

Model	Input Channel	Input Type	Input Range	CT Type	Cable	Output
DN-831I-100V-50A DN-831I-100V-200A DN-831I-100V-500A	1 x Voltage, 1 x Current	AC/DC	±100 Vpp, ±50 A ±100 Vpp, ±200 A ±100 Vpp, ±500 A	Clip-on	1.5 m/3 m	±10 Vpp
DN-843VI-600V	3 x Voltage	AC/DC	±600 Vpp	N/A	N/A	±10 Vpp
DN-848VI-10V DN-848VI-80V DN-848VI-150V	8 x Voltage	AC/DC	±10 Vpp, ±80 Vpp, ±150 Vpp	N/A	N/A	±10 Vpp
DN-843I-CT-1 DN-843I-CT-10 DN-843I-CT-20 DN-843I-CT-50	3 x Current	AC/DC	±1 A, ±10 A, ±20 A, ±50 A	Solid Core (closed)	N/A	±1.6 Vpp, ±10 Vpp, ±10 Vpp, ±4 Vpp
DN-844-50A DN-844-200A DN-844-500A	4 x Current	AC/DC	±50 A, ±200 A, ±500 A	Clip-on	1.5 m/3 m	±10 Vpp

# Industrial Multi-power-meter Display



### Features

- Built-in HMI for Information Display of Power Meters
- 4.3"/7" Colorful Display with Touch Panel
- IP40/IP60 Ingress Protection for Front Panel
- Built-in Real Time Clock
- Support Modbus TCP/RTU Protocols
- Support Max. of 8 Single-phase/3-phase Power Meters (PM-3xxx series) or One PM-4324
- Support Max. of 4 Modbus/TCP Connections for SCADA Software
- Support Phase Sequence Detection
- Support Fine Tune of Voltage and Current Ratio

## Introduction

The **Industrial Multi-power-meter Display** features 4.3"/7" high-resolution high-color TFT touch screen and IP40/IP65 waterproof. The built-in HMI screen pages for the information display of power meter, via the communication mechanism, can automatically display the meter information without additional programming. The multi-power-meter & multi-circuit device information can be shown in one display device, customers can now provide the display solution to the local end. Furthermore, the data can be integrated into the background SCADA control system, not only to get the power information, but also to facilitate the integration and configuration.

## Applications

### Multi-circuit Power Meter Display

ICP DAS Smart Power Meter with the compact size provides high-quality measurement accuracy. If customers need to display the power information in the field side, ICP DAS provides the 4.3"/7" Industrial Multi-power-meter Display series with our power meter products. Through the communication mechanism, the data of the multiple power meters can be presented on the built-in HMI screenpages, customers can provide this solution in the local end. Furthermore, the data can be integrated into the background SCADA control system, not only to get the power information, but also to facilitate the integration and configuration. Most multi-circuit meters are often difficult to display the numerical data in the local end, but our Industrial Multi-power-meter Displays can provide the multi-circuit power information on one device by switching the pages, so that the officer in the field side can quickly understand the power current status.

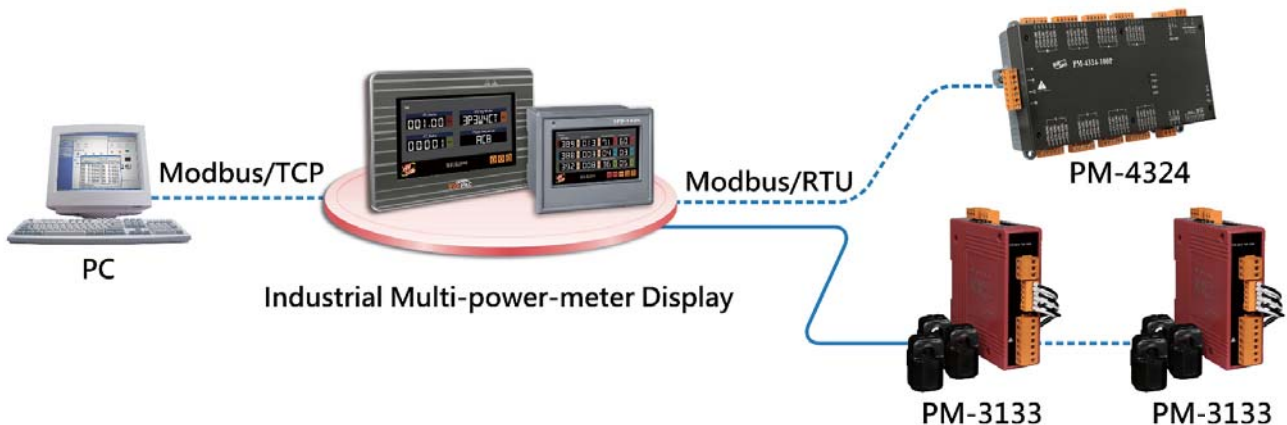

**Specifications**

Series	4.3 " Industrial Multi-meter TouchPAD		7 " Industrial Multi-meter TouchPAD	
Models	TPD-433-PM	VPD-143N-PM	TPD-703-PM	VPD-173-PM
<b>CPU Module</b>				
CPU	32-bit RISC CPU			
Memory Expansion	16 MB SDRAM / 8 MB Flash		16 MB SDRAM / 16 MB Flash	
Featured Items	Real Time Clock (RTC) / Buzzer / Rotary Switch (0~9)			
<b>Communication Interface</b>				
COM1	RS-485	One of RS-232 (3-pin) / RS-485 (including Self-Tuner)	RS-232 (3-pin); Non-isolation	
COM2	-		RS-485; Non-isolation	
Ethernet	Yes (RJ-45 x 1, 10/100 Base-TX)			
<b>MMI (Man Machine Interface)</b>				
LCD	4.3" TFT (Resolution 480 X 272 X 16)		7" TFT (Resolution 800× 480×16)	
Backlight Life	20,000 hours			
Brightness	400 cd/m2		250 cd/m2	
Featured Items	Touch Panel / LED Indicator / Reset Button			
<b>Mechanical</b>				
Dimensions (W x L x H)(mm)	126 x 82 x 24	131 x 105 x 54	217 x 153 x 33	213 x 148 x 44
Ingress Protection	Front Panel: IP40	Front Panel: IP65	Front Panel: IP40	Front Panel: IP65

**Meter Configuration Guide**

One Click!  
All Set!



IP3W → 3P3W4CT → **Set**

0 → 1 ..... 9 → **Set**

**Setting Method:**  
Keep clicking on the text or number until it reaches the required value and then press the "Set" button.

**Ordering Information**

<b>TPD-433-PM CR</b>	4.3" Industrial Multi-meter TouchPAD, IP40 Waterproof (RoHS)
<b>VPD-143N-PM CR</b>	4.3" Industrial Multi-meter TouchPAD, IP65 Waterproof (RoHS)
<b>TPD-703-PM CR</b>	7" Industrial Multi-meter TouchPAD, IP40 Waterproof (RoHS)
<b>VPD-173-PM CR</b>	7" Industrial Multi-meter TouchPAD, IP65 Waterproof (RoHS)

**Accessories**

 EWB-T43	External Wall Box for TPD-433-PM	 EWB-T70	External Wall Box for TPD-703-PM
 CA-USB10	USB to 5P Mini-USB, 28AWG, 1.5 m	DIN-KA52F CR	24 VDC/1.04 A, 25 W Power Supply, DIN-Rail Mountable (RoHS)

# Applications

## 1 LCD Panel Manufacturer:

Record and analyze power data of the robotic arms for transportation.

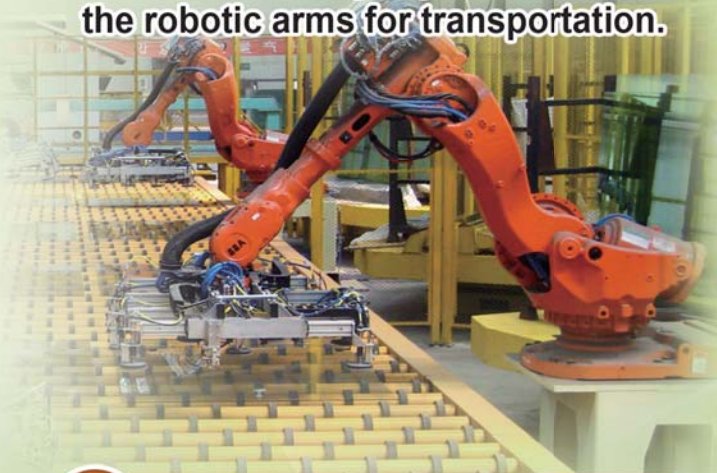

## 2 Semiconductor Manufacturer:

Record and analyze power data of the devices.



## 3 Machine Manufacturer:

Record and analyze power data of the machines.



## 4 Food Manufacturer:

Record and analyze power data of the refrigerator storage.



### Offices in Taiwan

#### Headquarter: Hsinchu

TEL: +886-3-597-3366  
FAX: +886-3-597-3733  
<http://www.icpdas.com>  
e-mail: [info@icpdas.com](mailto:info@icpdas.com)  
[sales@icpdas.com](mailto:sales@icpdas.com)

### Local Distributor



ICP DAS CO., LTD.

TEL : +886-3-597-3366

FAX : +886-3-597-3733

email : [sales@icpdas.com](mailto:sales@icpdas.com)

<http://www.icpdas.com>