

# Smart Building Smart Home Automation



**Smart Home  
Living Facilities Assistance  
Management Service  
Property Management**



# Table of Contents

## Chapter 1. Application Field .....

- 1-1 Central Monitoring . . . . . 3
- 1-2 Video Intercom . . . . . 4
- 1-3 HVAC . . . . . 5
- 1-4 Environmental Monitoring. . . . . 7
- 1-5 Electrical Devices. . . . . 8
- 1-6 Energy Management . . . . . 9

Application Field

## Chapter 2. System Solutions .....

- 2-1 Office Automation System . . . . . 10
- 2-2 Smart Building AI System . . . . . 11
- 2-3 Community Automation Overall System. . 12
- 2-3-1 Intelligent Curtain System . . . . . 14
- 2-3-2 Energy Management System for Community . 15
- 2-3-3 Leakage Monitoring System . . . . . 16
- 2-4 Home Automation System . . . . . 17
- 2-4-1 Intelligent Housekeeper System . . . 18

System Solutions

## Chapter 3. Product Series.....

- 3-1 Video Intercom & Access Control . . . . 19
  - HA / SI Series - Video Intercom
  - ACS Series - Access Control
- 3-2 Touch HMI - TouchPAD Series. . . . . 24
- 3-3 Smart Lighting Control . . . . . 28
  - LC / SC / DALI Series
- 3-4 Energy Management . . . . . 33
  - PM / PMC / PMD Series
- 3-5 Environmental Monitoring - CL Series. . 35
- 3-6 Environmental Monitoring - DL Series. . 39
- 3-7 Industrial Sensor Network - iSN Series. . 50
- 3-8 Motion Detector - PIR Series. . . . . 52
- 3-9 Wi-Fi Wireless - WF Series . . . . . 54
- 3-10 Voice Alert Module - ALM Series . . . . 56
- 3-11 ZigBee Wireless - ZT Series . . . . . 57
- 3-12 Infrared Wireless - IR Series . . . . . 60
- 3-13 IIoT Products . . . . . 63
  - IoT Cloud Management Software - IoTstar
  - IIoT Edge Controller - WISE Series
  - IIoT Communication Server - UA Series
  - Data Concentrator - ZT / MDC Series
- 3-14 WISE Surveillance: WISE + iCAM . . . 70
- 3-15 Smart Access Control . . . . . 78
  - WISE + ACS + Camera + Alarm
- 3-16 IIoT and Smart Phone Integration . . . 80
  - WISE + I/O Sensor + Camera + APP
- 3-17 Facial Identity System . . . . . 82
- 3-18 LED Display - iKAN Series . . . . . 84
- 3-19 Accessories . . . . . 86

Product Series



# Chapter 1. Application Field

## 1-1 Central Monitoring (Based-on InduSoft SCADA)

The central monitoring/control system of ICP DAS building automation provides more than 200 commonly used protocols for communication and interfaces for data exchange. InduSoft SCADA software provides total solutions and sample references to simplify operations such as: read/write interfaces (UART, TCP, UDP) from the lower-layer communication ports commonly used in industrial/power control, support plug and play to external devices (.Net components, Dynamic-link library...), be able to access the database (MS SQL Server, Oracle, etc.), moreover, web service data exchange. The system integrators can implement projects without any extra effort.

( InduSoft Web Studio Software: <http://www.icpdas.com/products/Software/InduSoft/indusoft.htm> )



### ● Recommend Products:

<b>InduSoft Software</b>	IWS Development Package for Windows IWS Runtime Package for Windows / Windows Embedded CE
<b>BA/HA All Series</b>	All BA/HA Series in the Smart Building/Home Solutions

# 1-2 Video Intercom (Building Management with IoT)

In BA & HA applications, the system aims to build an intelligent community system platform. Clients can reduce costs with this system because of its high compatibility and being able to sharing devices. The **HA** series, **SI** series and **ACS** series of ICP DAS products provide an intelligent host solution for indoor and outdoor Smart Building and Smart Home applications. Combining these series together with IoT technologies, an entire intelligent system platform can be created to enhance the efficiency of building management.

Application Field

**HA-401 Security Situation Control Intercom Host**

**Lighting Control**

- 2-way/3-way switches, dimming control
- Scheduling control

**Community Bulletins**

- Community announcements
- Publish advertising, news
- Publish/subscribe topics...

**Video Intercom**

- House-to-house
- House-to-caretaker
- Remote access setting

**Security System**

- Arm Away/Night modes
- Fire, gas leaks alerts
- Earthquakes alerts

**Energy Consumption**

- Electricity, water usage
- Natural gas usage
- Measure, record, display...

**Environmental Monitoring**

- Temperature, humidity, PM2.5, CO, CO2, noise levels...
- Rainfall, wind speed, current weather...

**SI Series Video Intercom Door Station**

**ACS Series Access Control Reader with Proximity Card**

● **Recommend Products:**

<b>HA Series</b>	Security Situation Control Intercom Host	HA-401
	IP PBX	HA-5231M
<b>SI Series</b>	Video Intercom Door Station	SI-002
<b>ACS Series</b>	Access Control Reader with Proximity Card	ACS-10V-MF, ACS-10VP-MF
	Access Control Reader with Proximity Card and Keypad	ACS-11-MF, ACS-11P-MF



# 1-3 HVAC

The HVAC (Heating, Ventilation, and Air Conditioning) systems are slightly different from its appearance and structure. A full functioned HVAC system requires both software and hardware, air-cooled chillers, steam boilers or other large equipment, as well as cold or hot pumps to send in/out water, and the air-handling unit for regulation & circulate air. The widely used intelligent air conditioning software usually provides soft logic development kit that is IEC-61131 compliance. In addition, the back-end SCADA software also uses in various HVAC systems.

## ICP DAS Products for HVAC System

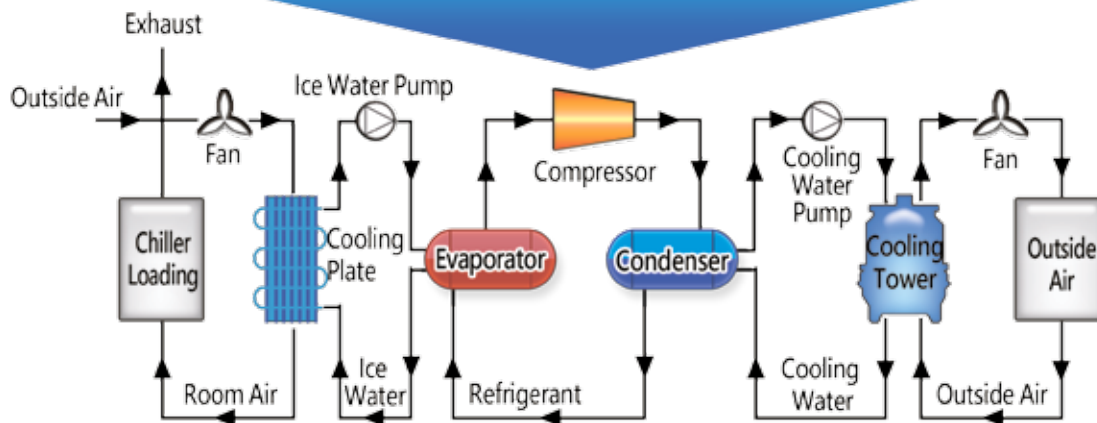
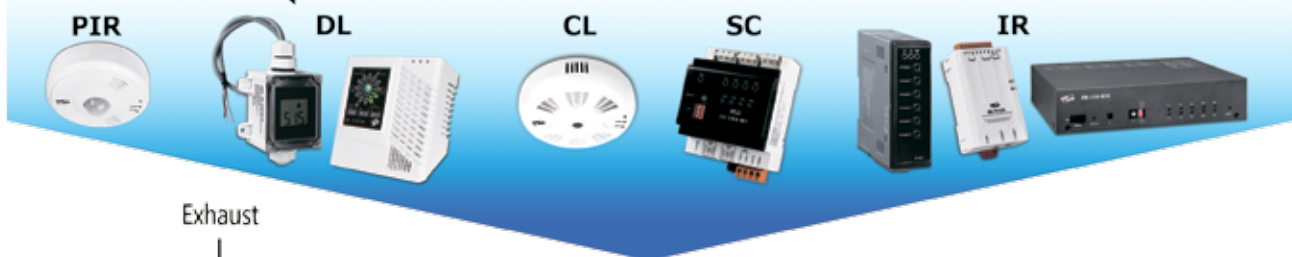

### ● Recommend Products:

<b>DL Series</b>	Temperature/Humidity Data Logger	DL-10, DL-100, DL-101, DL-110 series...
	CO/CO2/NH3/TVOC/HCHO Data Logger	DL-301/302/303/304/305/306/307/308 series & IP65 series...
<b>CL Series</b>	CO/CO2/T./H./HCHO/CH4/PM2.5 Sensor	CL-201/202/203/204/205/206/207/208 CL-210/211/212/213 CL-220/221/222/223/224/225/226/227/228/229
<b>SC Series</b>	Smart Control Multi-function Module	SC-6104-W5
<b>PIR</b>	Motion Detector: PIR	PIR-130/230/231
<b>IR Series</b>	IR Learning Remote Module	IR-210, IR-712A, IR-712-MTCP
	IR Controlled Power Relay Module	IR-310-RM
<b>TouchPAD Series</b>	TPD 2.8" / 4.3" / 7" HMI Device	TPD-28x-H, TPD-43x-H, TPD-703 ...
	VPD 3.5" / 4.3" HMI Device	VPD-13x-H, VPD-14x-H, VPD-173N, XV-board

Application Field

● HVAC Application:

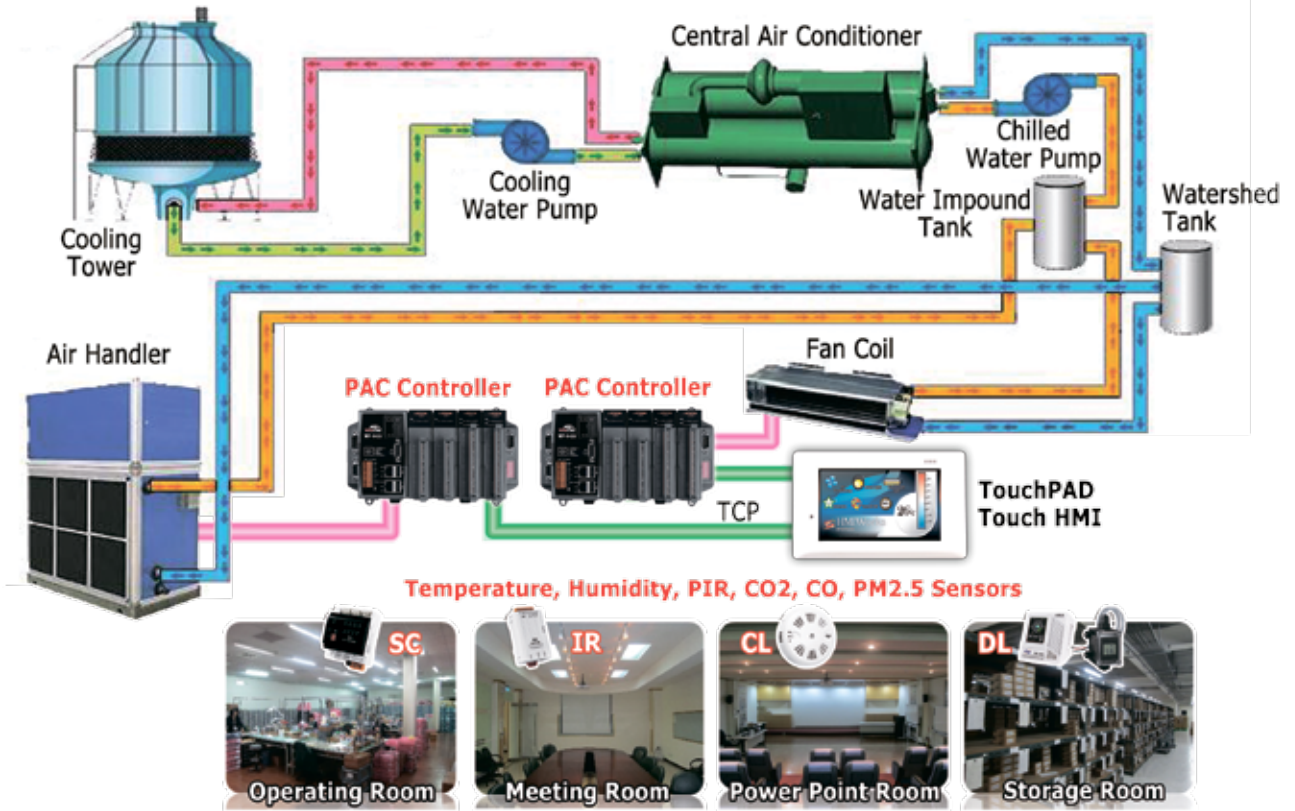

Application Field

● FCU (Fan Coil Unit) Control System:

FCU system widely use in commercial building, with SC series relay board and TPD series thermostat, it allows to set up the indoor temperature. The SC series focus in controlling air flow of FCU, and the flow rate of the 2-way valve or 3-way valve for the chilled-water and hot-water in FCU. Moreover, connecting FCU with TPD series provides user-friendly interface to easy touch and set up the temperature and air flow on the screen.

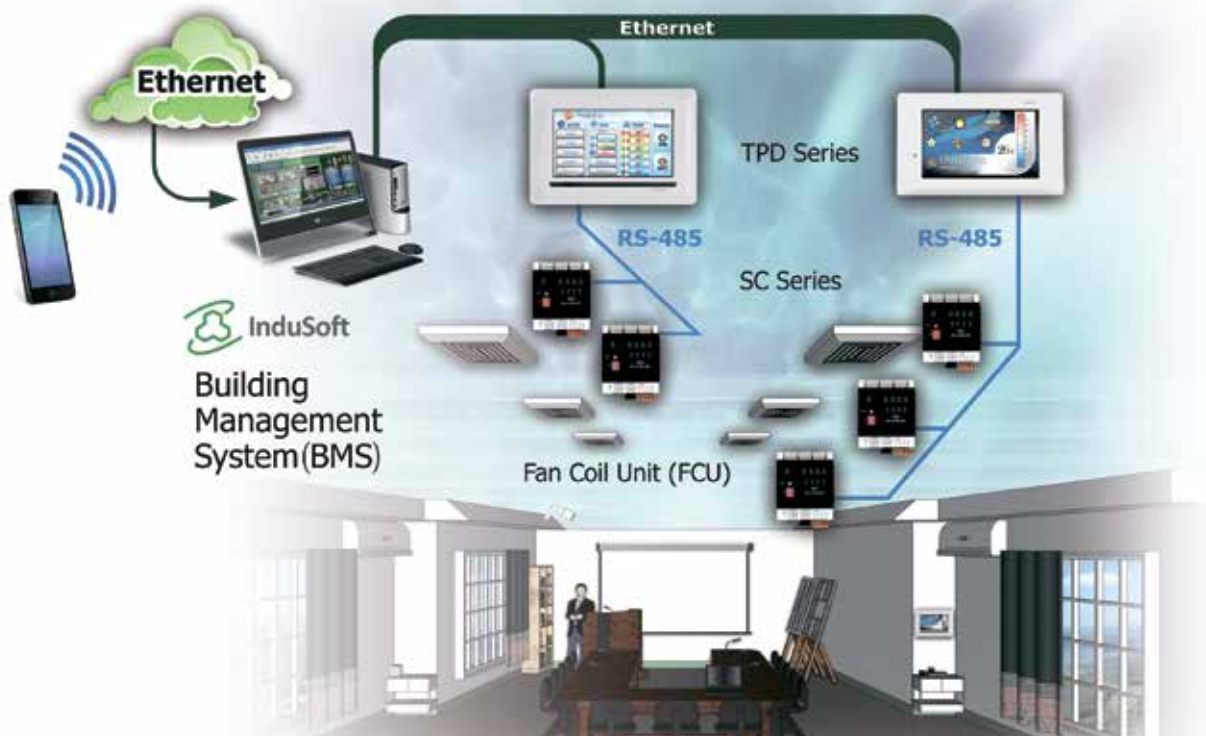



# 1-4 Environmental Monitoring

The environmental safety should be considered during constructing. For those old buildings, this can be solved by adding new technology products, such as those devices which could do monitor and detect CO, CO2, PM2.5, formaldehyde (HCHO), methane (CH4), temperature, humidity, body motion detection, infrared, and etc. ICP DAS environmental sensor series not only detect the environment and trigger the alarm, but also create the linkage reaction among devices to notify the control center and make follow-up process immediately. With ZigBee wireless series, when detecting the smoke, it can immediately trigger the alarms, connect to smoke dampers, enable the indicator for escape route, notify the control center, and evacuate people with the instructions to reduce further disaster.

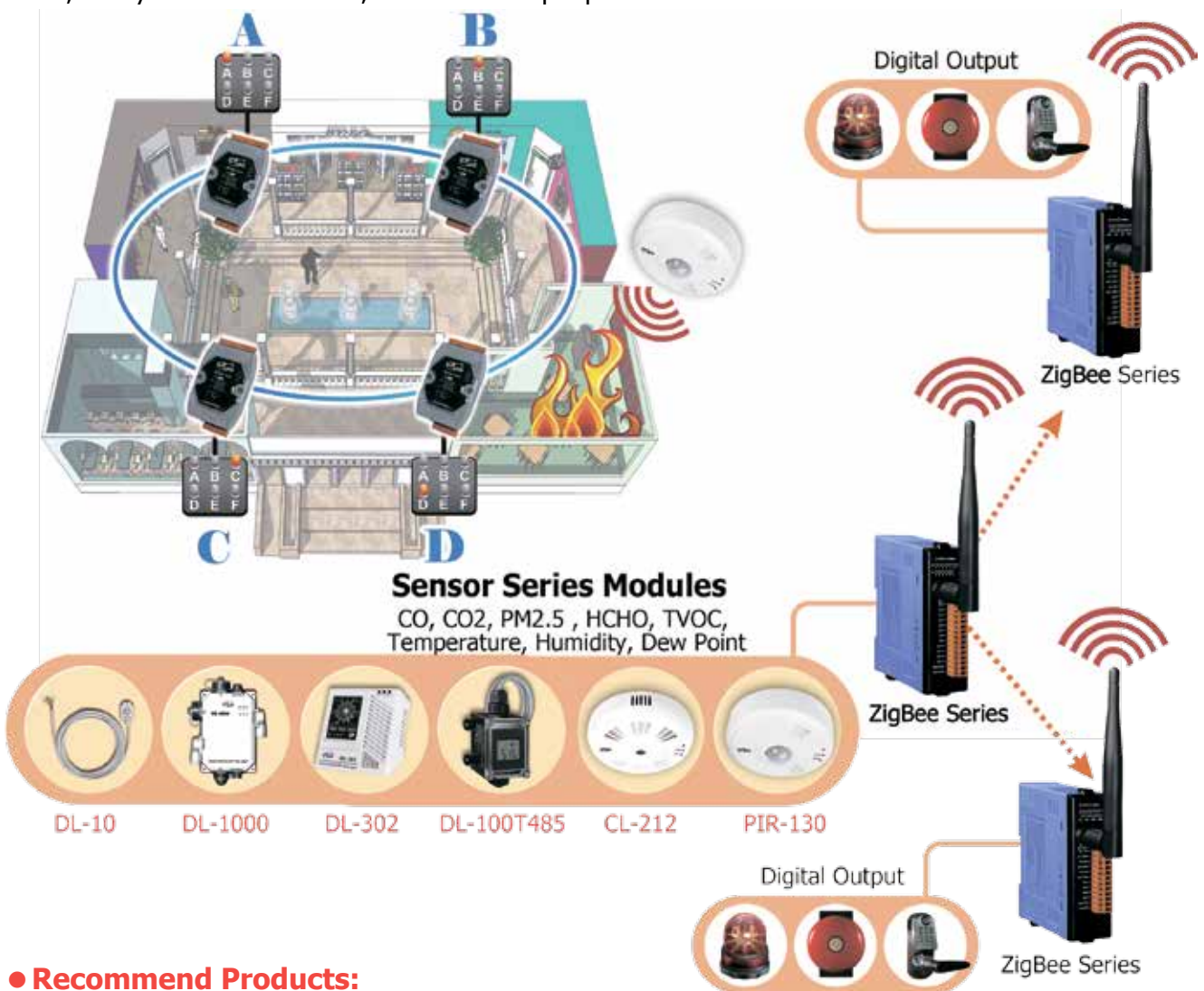

Application Field

● **Recommend Products:**

<b>ZigBee Wireless Series</b>	ZigBee Converter/Repeater/Bridge	ZT-2550, ZT-2570, ZT-USBC, ZT-2510, ZT-2530M
	ZigBee Pair-connection I/O Module	ZT-2053-IOG, ZT-2055-IOG, ZT-2060-IOG ...
	ZigBee I/O Module	ZT-2015, ZT-2042, ZT-2053, ZT-2060, ZT-2055...
<b>DL Series</b>	Temperature/Humidity Data Logger	DL-10, DL-100, DL-101, DL-110 series...
	CO/CO2/NH3/TVOC/HCHO Data Logger	DL-301/302/303/304/305/306/307/308 series & IP65 series...
<b>CL Series</b>	CO/CO2/T./H./HCHO/CH4/PM2.5 Sensor	CL-201/202/203/207/208/210/211/212/213...
<b>PIR</b>	Motion Detector: PIR	PIR-130/230/231

# 1-5 Electrical Devices

The electrical devices in a building includes HVAC, power monitoring, lighting, water supply & wastewater disposal, fire monitoring and access control, and etc. Usually firefighting system may require an authorized license for control operations monitoring signal, while for other electrical devices, the control/monitoring operations can be done easily after the control sequences being clarified or verified by professional technicians. With the help of remote I/O and TPD series, the schedule operations, linkage actions, on-site monitoring/control, troubleshooting operations and maintenance can be easy, and reduce your expenditure.

Application Field

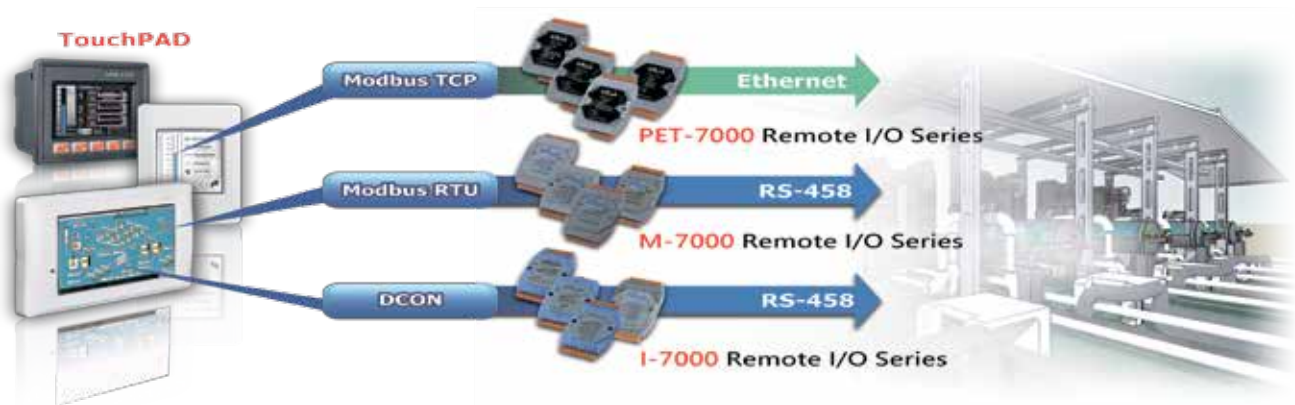

<b>TPD-433-Mx with External Wall Box, EWB-T43F</b>		<b>TPD-433-Mx with Outlet Box, OB120</b>	
<b>TPD-433-Mx with Outlet Box, OB140F</b>		<b>TPD-433-Mx with Outlet Box, OB140FP</b>	

**● Recommend Products:**

<b>TouchPAD Series</b>	TPD 2.8"/ 4.3"/ 7" HMI Device	TPD-28x-H, TPD-43x-H, TPD-433-Mx, TPD-703 ...
	VPD 3.5"/ 4.3"/ 7" HMI Device	VPD-13x-H, VPD-14x-H, VPD-173N...
<b>I/O Series</b>	Remote I/O Modules	I-7000, M-7000, ET-7000, tM Series...
	Remote I/O Expansion Unit	RU-87Pn, ET-87Pn, USB-87Pn...



# 1-6 Energy Management

ICP DAS provides an innovative total solution for energy management. It can measure and monitor the power consumption of the devices, machines, lighting, air conditioning or other electricity equipment to achieve more efficiency of energy and reduce resources waste. This innovative total solution includes front end Smart Power Meter, PMC/PMD Power Meter Concentrator, back-end software tool for database import operation (PMC Data Server) and InduSoft SCADA software. Based on the total solution, the user could easily view power data through their mobile phones or PC, the administrator could set up the system quickly, and the data can be recorded in real time for energy consumption status to achieve effective energy management.

Application Field

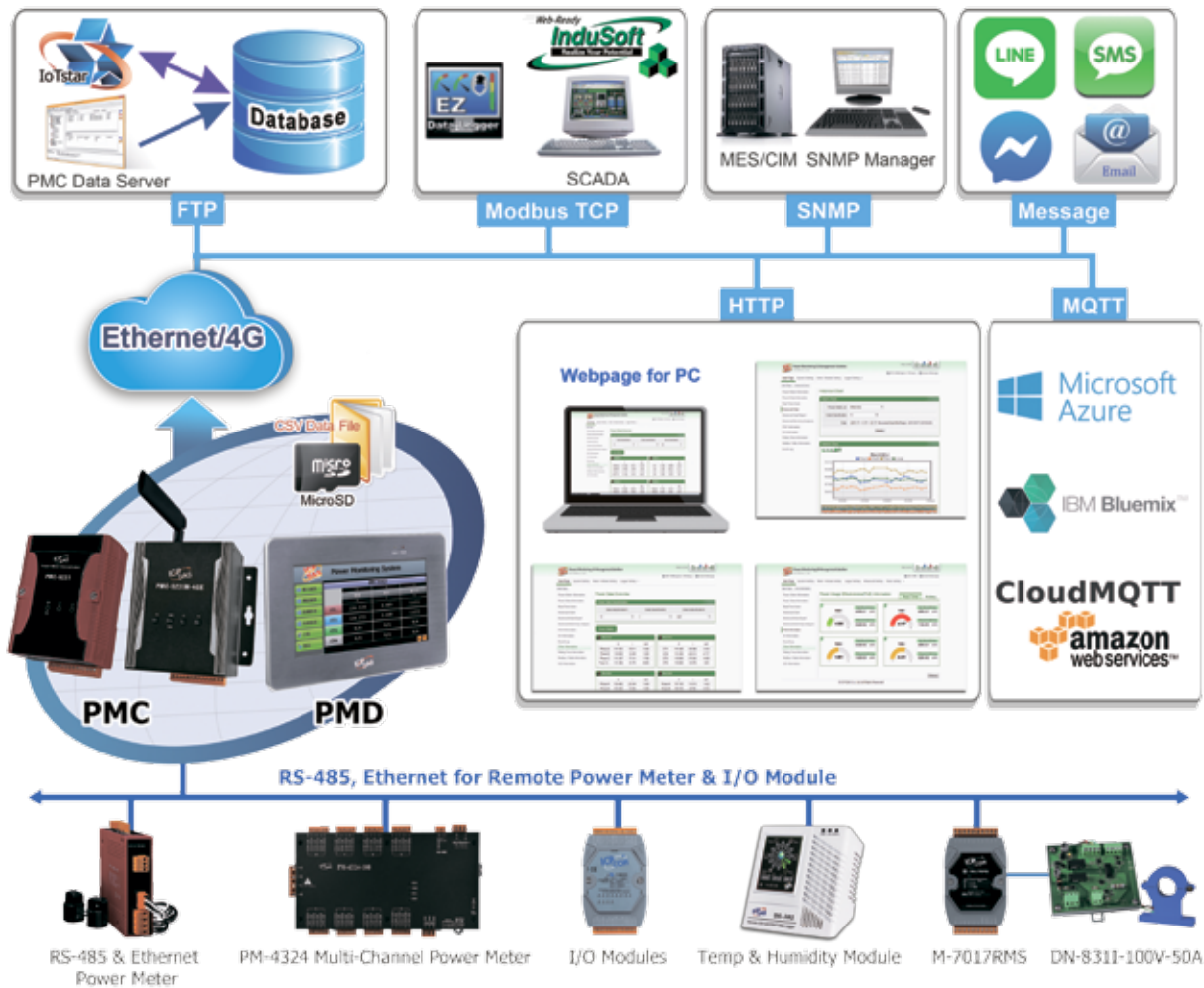

● **Recommend Products:**

<b>Power Series</b>	PMC: Power Meter Concentrator	PMC-5231, PMC-5231M-3GWA, PMC-5231M-4GE, PMC-2241M
	PMD: PMC with Touch Panel	PMD-6201 (15"), PMD-4201 (10.4"), PMD-2201 (7")
	PM Smart Power Meter	PM-3033, PM-3133, PM-4324 Series (3-Phase) PM-3112, PM-3114 Series (Single-Phase)
<b>Power Related Device</b>	True RMS Input Module	M-7017RMS

# Chapter 2. System Solutions

## 2-1 Office Automation System

### Product Series:

- LC Series
- SC Series
- IR Series
- PM Series
- PIR Sensors
- ACS/SI Series
- TPD Series
- CO/CO2/T./H. Sensors
- Facial Identity
- Leakage Monitoring



System Solutions



## 2-2 Smart Building AI System - AI Integration

### LED Display

#### Products:

- iKAN Series

### Facial Identity

#### Products:

- Wi-Fi Series
- Camera Series

### Environment

#### Products:

- DL/CL Series
- LC Series
- ZigBee Wireless

### Air-conditioning

#### Products:

- SC Series
- IR Series
- LC Series

## iKAN Facial Identity Integration Achieve Front-end Information Integration

### Building Information Notice

#### Introduction

The delivery of traditional community information is often slow and unable to deliver just in time or might have chances to lose it. Now ICP DAS can solve this by using the combination of the facial identity and smart LED display. This solution can deliver information to the building residents right away.



#### Application Site

Community, school, company, factory, bank, hospital, etc.

### Air Quality Monitoring

DL-302 can detect humidity, temperature and CO2 air quality at the same time and display it on iKAN smart LED displays without connecting to a host computer.



**iKAN and DL-302**  
do not need to connect to  
a host computer.



**DL-302**

# 2-3 Community Automation Overall System

## Air Conditioning Control

### Product Series:

- SC Series
- IR Series
- LC Series

## Power Monitoring System

### Product Series:

- PM Series
- PMC Series
- PMD Touch Series

## Facial Identity License Plate Recognition Parking Lot Management

### Product Series:

- Wi-Fi Series
- Camera Series

System Solutions





## Environmental Monitoring/Security

### Product Series:

- LC Series
- ZigBee Series
- DL/CL Series

## Lighting/Scenario Control

### Product Series:

- LC Series
- DALI Series
- TPD HMI Series



# 2-3-1 Intelligent Curtain System

## Product Series:

- WISE Series
- DL Series
- SC Series
- TPD Touch HMI Series
- LC Series

## Intelligent Curtain

### Achieve Intelligent Home Automation

WISE-5231 can integrate the electric curtains and sensors in the home environment. With the easy-to-use web interface and logic control operation capability of WISE, the intelligent curtain system can be built in an easy way and interact with the Building Management System (BMS). In addition, WISE can collect the sensor data all around the house. When the indoor temperature and humidity rises or the intensity of sunshine is strong, the electric curtain can be automatically adjusted to make the environment more comfortable, or the personalized setting can be performed to control a specific curtain. Schedule function of WISE can also be used to automatically perform a personal scenario operation for the electric curtains at the scheduled time.



### APP Operation Mode

Users can set up a personal scenario by using APP and TPD to control electric curtains in the home environment so that the electric curtain can be operated automatically at the scheduled time.



# 2-3-2 Energy Management System for Community

## Product Series:

- PMC/PMD Series**
- LC Series**
- PM Series**
- TPD Touch HMI Series**
- DL Series**
- SC Series**

## Intelligent Energy Management

### Achieve Intelligent Facility Management

The solution "PMC+IoTstar" has the advantages to integrate IoT and Cloud operation. It can collect the sensor data of water, electricity and gas consumption from the public facilities of the Community such as elevators, halls, playrooms, audio-visual rooms, gyms, laundry rooms, fountains, swimming pools, and etc.; and then save these sensor data into the cloud storage. Based on the collected data and preprocessed operation, the staff can continue to use the data analysis tool to analyze the status of the facilities in the community to prevent from the damage and maintain the operation of the facilities, reduce the maintenance cost, and improve the efficiency of the energy consumption.



System Solutions

# 2-3-3 Leakage Monitoring System

## Product Series:

- GRP Series
- TPD Series
- iSN Series

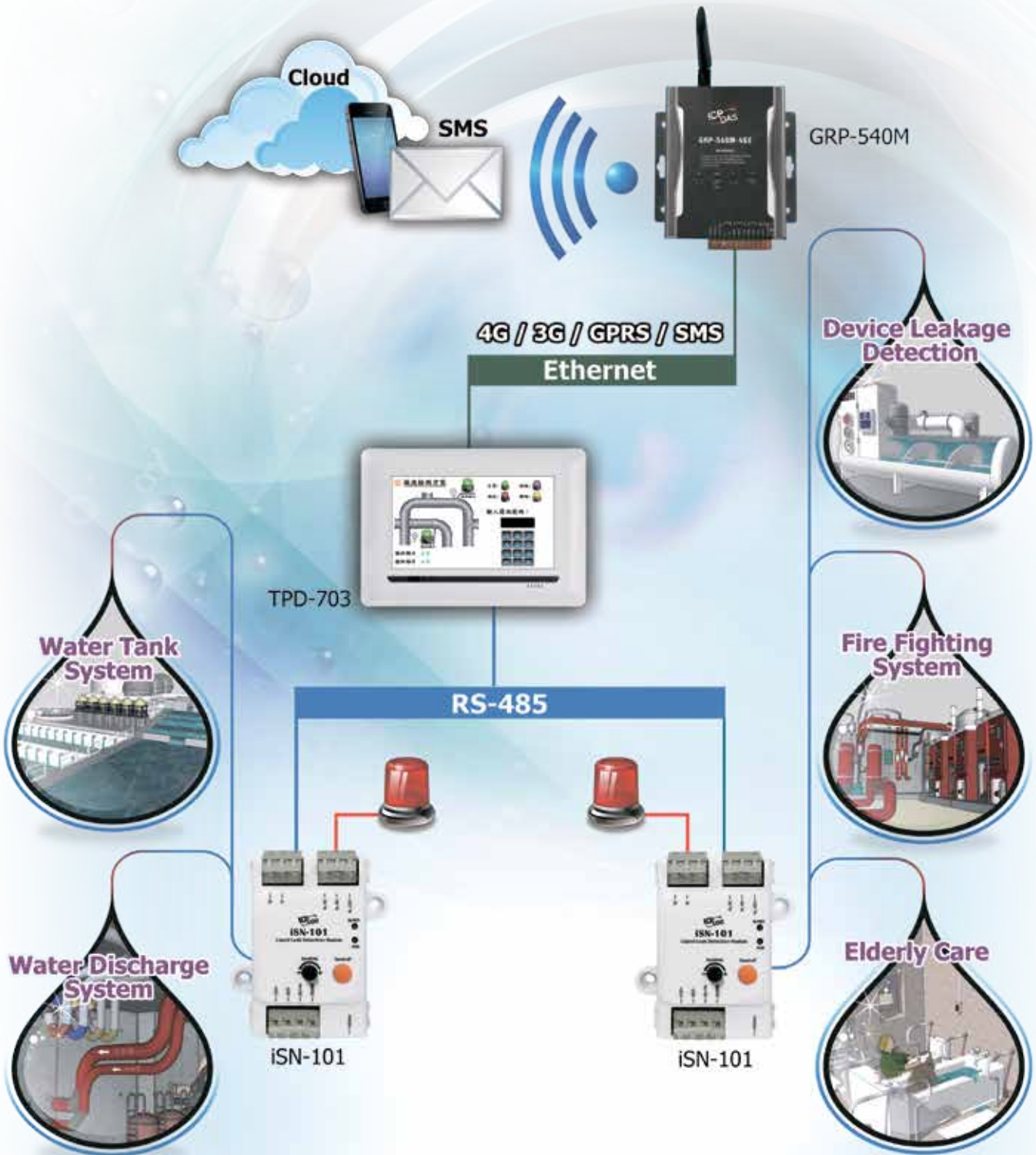

System Solutions



# 2-4 Home Automation System

## Product Series:

- Wi-Fi Series
- IR Series
- PM Series
- PAC Controller
- ZigBee Series
- LC Series
- TPD HMI Series

## Features

- TouchPAD provides scenarios control (Lighting, Dimmer, Air Conditioning, Multimedia, etc.) to replace the traditional mechanical switches.
- Lighting control with TouchPAD HMI and ZigBee wireless forms an easy controlling network.
- The three-phase meter can show the power consumption of different scenarios immediately.
- Smart Phone via Wi-Fi can link the PAC controller to enable the HA automation.



## Smart Phone Control

By ICP DAS PAC controller (built-in Web Server & Web DLL), Smart Phone can connect via Wi-Fi to the PAC controller for simultaneously remote-controlling what TouchPAD locally does.



TouchPAD (Support Multi-language)



Smart Phone

# 2-4-1 Intelligent Housekeeper System

**Product Series:**

- **WISE Series**
- **LC Series**
- **PM Series**
- **TPD Touch HMI Series**
- **DL Series**
- **SC Series**

## Intelligent Housekeeper

### Achieve New Life with IoT

WISE can connect to a variety of environmental sensors to automatically monitor and record the changes of temperature, humidity, air quality and other sensor data in your home. Based on the built-in intelligent logic engine, WISE can help you to quickly build your own intelligent housekeeper system. Through the integration with the intuitive interface provided by APP and TPD, users can control various electrical devices inside the house in just one click. WISE supports the integration via mobile communication to monitor all devices at home and cloud services no matter where you are.

System Solutions





## Chapter 3. Product Series

### 3-1 Video Intercom & Access Control Series

This series, mainly for the smart community & building systems, include HA series (Intercom host), SI series (Intercom door station) and ACS series (access control card reader).

**HA Series** is an intercom host that supports security situation in such following scenario like: integrating functions related to the message notifications, security alarms, community bulletins, interior environment control, visitor intercom, and push advertising.

**SI Series** is video intercom door station that supports VoIP technology and SIP communication protocol. With HA-401 product, households can see visitor's images and have a video conversation.

**ACS Series** is an access control reader that supports keypad and RFID induction of access control. It integrates three functions in one unit: door access control, voice guidance and floor control.

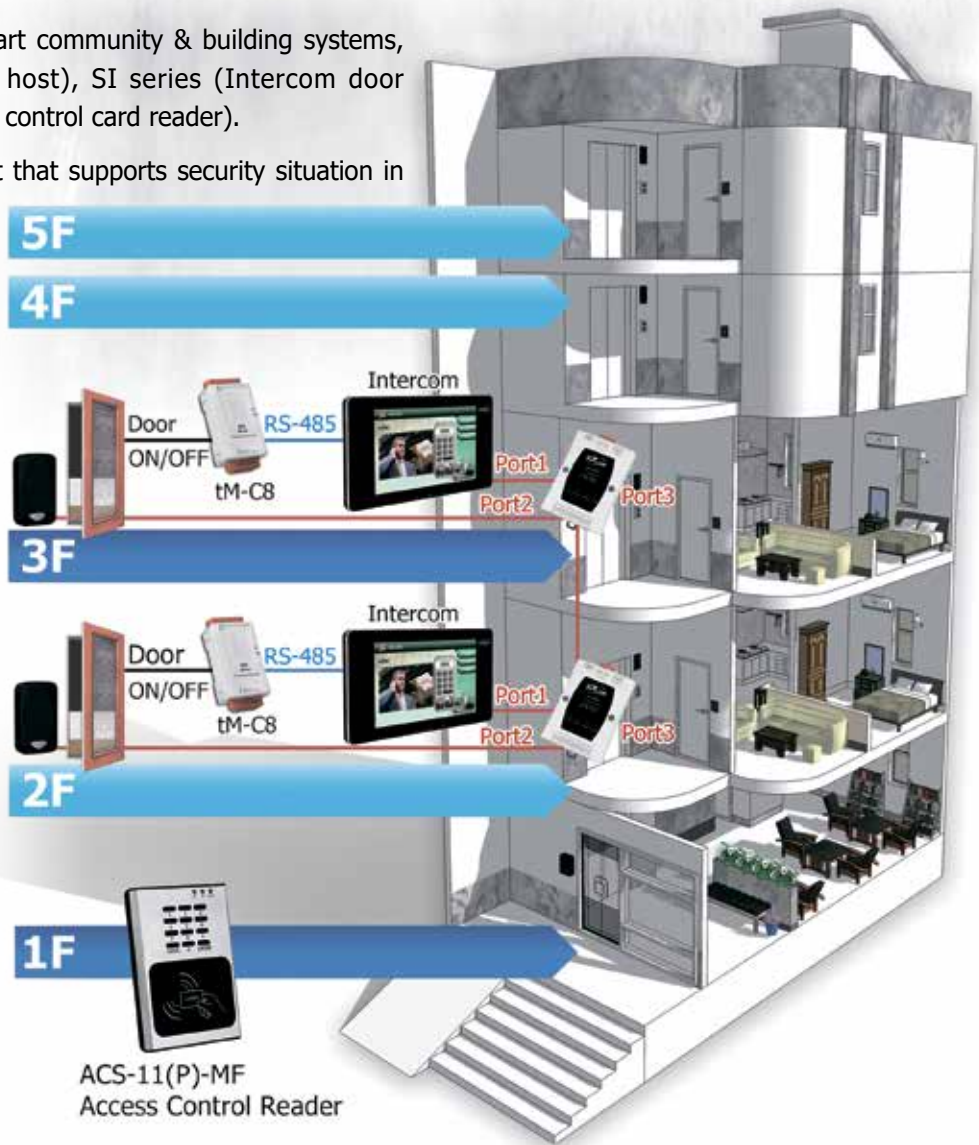

#### Selection Guide

Video Intercom & Access Control Series	
<b>HA-401</b>	Security Situation Control Intercom Host
<b>HA-5231M</b>	IP PBX
<b>SI-002</b>	Video Intercom Door Station
<b>ACS-10V-MF-TC</b>	Access Control Reader with Proximity Card (Chinese version of voice)
<b>ACS-10VP-MF-TC</b>	PoE Access Control Reader with Proximity Card (Chinese version of voice)
<b>ACS-10V-MF</b>	Access Control Reader with Proximity Card (English version of voice)
<b>ACS-10VP-MF</b>	PPoE Access Control Reader with Proximity Card (English version of voice)
<b>ACS-11-MF-TC</b>	Access Control Reader with Proximity Card and Keypad (Chinese version of voice)
<b>ACS-11P-MF-TC</b>	PoE Access Control Reader with Proximity Card and Keypad (Chinese version of voice)
<b>ACS-11-MF</b>	Access Control Reader with Proximity Card and Keypad (English version of voice)
<b>ACS-11P-MF</b>	PoE Access Control Reader with Proximity Card and Keypad (English version of voice)

# HA Series: Security Situation Control Intercom Host



**HA-401**

## Features



- Full-duplex voice and video intercom (Support SIP)
- 10.1" WXGA color TFT-LCD touch screen
- Full HD Front-facing camera (1080p)
- Display for the date, time, T&H, PM2.5, noise levels...
- Smart home control (lighting, TV, air conditioner...)
- Energy monitoring and management capabilities
- Community announcements and publish advertising
- Interactive M2M transmission technology: MQTT, LINE

## Introduction

**HA-401 is an intercom host that supports security situation control,** integrating functions related to message notifications, security alarms, community bulletins, interior environment control, visitor intercom, and publish advertising. The HA-401 uses advanced automatic control, database software, computer network communication technology, and building message management, combined with a Smart Home system, to achieve intelligent indoor control.



### Video Conversation



### Environmental Monitoring



### Security Alarm



### Information Notice



## Specifications

Controller		
CPU	32-bit, 1000 MHz	
DDR3 SDRAM	512 MB	
NAND Flash	4 Gb	
EEPROM	128 KB; Data Retention: 40 years; 1,000,000 erase/write cycles	
RTC	Provide second, minute, hour, date, day of week, month, year	
Communication Interface		
Ethernet	RJ-45 x 1, 10/100 Base-T (Auto-negotiating, Auto MDI/MDI-X, LED indicators)	
USB 1.1	1 (Client/Mini-USB)	
COM Port	COM1: RS-485 x1 (TB and RJ-11) COM2: RS-232/485 x1 (TB)	
Digital Input		
Channels	2	
Input Type	Dry contact (Source)	
Dry Contact Level	Off Voltage Level: Open	On Voltage Level: Close to GND
Relay Output		
Channels	2	
Output Type	1 Form A	1 Form C
Contact Capacity	5 A @ 250 VAC; 5 A @ 30 VDC	0.6 A @ 125 VAC; 2 A @ 30 VDC
Endurance	Mechanical: 2 x 10 <sup>7</sup> ops. Electrical: 1 x 10 <sup>5</sup> ops.	Mechanical: 1 x 10 <sup>8</sup> ops. Electrical: 5 x 10 <sup>5</sup> ops.

HMI	
LCD	10.1" TFT (Resolution 1280 x 800)
Backlight Life	20,000 hours
Brightness	350 cd/m2
Camera	1080P (1920 x 1080), CMOS Sensor
Touch Screen	5-wire, analog resistive; Light Transmission: 80%
Audio	AMP 2.5 W; Digital microphone
Power Supply	
Input Range	12 V ~ 48 VDC
Consumption	4.0W
Protection	Reverse Polarity Protection
Power Switch	Yes
Mechanical	
Installation	Wall Mounting (Suitable for the European 86 mm x 86 mm outlet box)
Dimensions	311 mm x 36 mm x 181 mm (W x L x H)
Environment	
Operating Temperature	-10°C ~ +60°C
Storage Temperature	-20°C ~ +70°C
Humidity	10% ~ 90% RH, non-condensing



# HA Series: IP PBX

## Features



- VoIP Protocol : SIP (Session Initiation Protocol)
- Audio Codec: PCMU, PCMA, GSM, G.722
- Video Codec: H.263p, VP8, H.264
- Support pass through video call
- Up to 256 extensions
- Up to 8 SIP trunk
- Call Detail Records
- Flexible Extension manager
- Provide network firewall functionality
- Operating Temperature: -25 ~ +75°C



**HA-5231M**



## Introduction

**HA-5231M** is a IP PBX that is built over IP-based architecture for delivering and managing voice and video communication services. It allows the phones to talk to each other by voice and video. These phones can be a SIP phone, Software Phone, the ICP DAS HA-401, SI-002 and so forth. In addition, we also provide the utility software for users to configure the HA-5231M. By using this module, users can manage their SIP phone easier and more flexible.

### VoIP Phone System



### Free International Calling



## Specifications

System Software	
OS	Linux Kernel 3.2.14
Embedded Service	SIP, SSH
CPU Module	
CPU	AM3354, 1 GHz
DDR3 SDRAM	512 MB
Flash	512 MB
EEPROM	64 KB
Expansion Flash Memory	microSD socket (support up to 32 GB microSDHC card)
RTC (Real Time Clock)	Provide second, minute, hour, date, day of week, month, year
64-bit Hardware Serial Number	Yes, for Software Copy Protection
LED Indicator	4 LED (PWR, RUN, L1, L2)
Rotary Switch	Yes (0 ~ 9)

Communication Ports	
Ethernet	RJ-45 x 1, 10/100 Base-T (Auto-negotiating, Auto MDI/MDI-X, LED Indicators)
USB 2.0 (Host)	1
Console Port	RS-232 (Rx/D, Tx/D and GND); Non-isolated
ttyO2	RS-485 (Data+, Data-); Non-isolated
ttyO4	RS-232 (Rx/D, Tx/D and GND); Non-isolated
ttyO5	RS-485 (Data+, Data-); 2500 VDC Isolated
Power	
Input Range	12 V ~ 48 VDC
Consumption	4.8 W
Mechanism	
Installation	DIN-Rail
Dimensions	72 mm x 33 mm x 119 mm (W x L x H)
Environment	
Temperature	Operating Temperature: -25°C ~ +75°C Storage Temperature: -30°C ~ +80°C
Humidity	10% ~ 90% RH, non-condensing

Product Series

# SI Series: Video Intercom Door Station

## Features



SI-002

- Full-duplex voice and video intercom
- Support for SIP communications architecture
- Using high-resolution camera 1080P (1920 x 1080)
- Advanced echo cancellation technology
- Built-in high sensitivity microphone and speaker
- Built-in call button
- Built-in Relay output channel (door control or alarms output)
- Built-in Digital input channel (door magnetic switch detection or external emergency button)
- Support Card Type: Mifare Classic, Ultralight, DESFire

## Introduction

**SI-002** is video intercom door station that supports VoIP technology, SIP communication protocol and RFID induction. With the HA-401 product, households can see visitors' image and have a video conversation with them when the doorbell ringing. After the identity confirmation, they can open the door remotely. Also, users can upload an image shot via FTP. Using high-resolution CMOS camera and advanced echo cancellation technology can show a clearer picture and excellent audio quality and timeliness of transport. It is a compact video intercom solution for building residential.

## Applications

- Voice Conversation
- Remote Door Control
- One-touch Calling
- Video Surveillance
- Door Position Detection
- LINE Real-time Information Notice

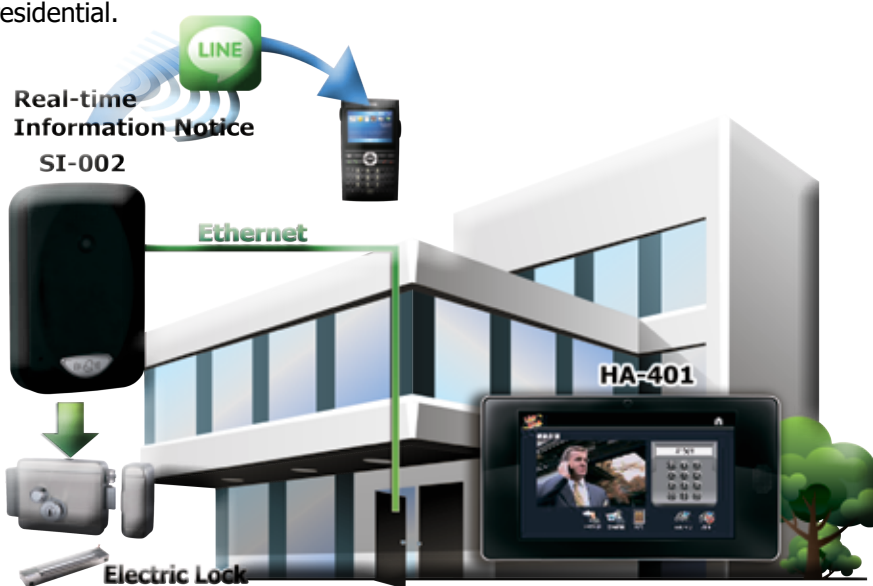

## Specifications

Communication Interface		
Ethernet	RJ-45 x 1, 10/100 Base-T (Auto-negotiating, Auto MDI/MDI-X, LED indicators)	
Digital Input		
Channels	2	
Input Type	Dry contact (Source)	
Dry Contact Level	Off Voltage Level: Open	On Voltage Level: Close to GND
Relay Output		
Channels	1	
Output Type	Form C (N.O./COM./N.C.)	
Contact Capacity	0.6 A @ 125 VAC; 2 A @ 30 VDC	
Endurance	Mechanical: 2 × 10 <sup>8</sup> ops.	Electrical : 1 × 10 <sup>5</sup> ops.
RFID		
Frequency	13.56 MHz	
Supported Card	Mifare Classic, Ultralight, DESFire	

HMI	
Camera	1080P (1920 x 1080), CMOS Sensor
Audio	AMP 2.5 W; Digital microphone
Mechanical	
Installation	Wall Mounting (Suitable for the European 86 mm x 86 mm outlet box)
Dimensions	102 mm x 161 mm x 41 mm (W x L x H)
Environment	
Temperature	Operating: -10°C ~ +60°C
	Storage: -20°C ~ +70°C
Humidity	10% ~ 90% RH, non-condensing
Power Supply	
Input Range	12 V ~ 48 VDC
Consumption	1.68 W (70 mA @ 24 VDC)
Protection	Reverse Polarity Protection



# ACS Series: Access Control Reader with Proximity Card



**ACS-10V-MF**  
**ACS-10VP-MF**



**ACS-11-MF**  
**ACS-11P-MF**

## Features



- Supports RFID induction control
- Supports Card Type: Mifare Classic, Ultralight, DESFire
- Built-in Voice Message Function
- Supports Ethernet/RS-485/CAN Bus Interface
- Built-in RTC and WDT
- Electric Door Lock Control and Door Position Detection
- Provides Access Records
- Max Card Capacity: 8192 Cards
- Supports Elevator Floor Control (Max. 16 F)

## Introduction

**ACS Series** is an access control reader that supports keypad and RFID induction of access control. It integrates three functions of door access control, voice guidance and floor control all in one, suitable for use in community door access and elevator control.

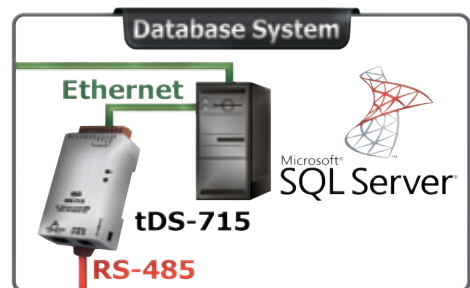

## Specifications

Model	ACS-10V-MF ACS-11-MF	ACS-10VP-MF ACS-11P-MF
CAN Bus		
Baud rate	1M (bps)	—
Specification	ISO-11898-2, CAN 2.0A/B	—
UART		
COM	RS-485 (D+, D-)	
Baud rate	9600 (bps)	
Format	N, 8, 1	
Ethernet		
Controller	10/100Base-TX Ethernet Controller (Auto-negotiating, Auto MDIX)	
Connector	RJ-45 with LED indicator	
Digital Input		
Channels	4	2
Input Type	Dry contact (Source), Wet Contact (Sink, Source)	
Relay Output		
Channels	2	
Output Type	Form C	
Contact Capacity	0.5A 120 VAC / 2A 30 VDC	

Model	ACS-10V-MF ACS-11-MF	ACS-10VP-MF ACS-11P-MF
RFID		
Supported Card	Mifare Classic, Ultralight, DESFire	
Standard	ISO 14443 A	
Keypad		
Supported	ACS-11-MF/ACS-11P-MF: Yes ACS-10V-MF/ACS-10VP-MF: No	
Power		
Protection	Yes, Reverse Polarity Protection	
Input Power	From CN1 Connector, 10 V ~ 30 V	PoE, IEEE 802.3af, Class1
Consumption	2.0 W	1.7 W
Mechanical		
Installation	Wall Mounting (Suitable for the outlet box in United States)	
Dimensions	83 mm x 120 mm x 28 mm (W x L x H)	
Environment		
Temperature	Operating: -20°C ~ +60°C Storage: -30°C ~ +80°C	
Humidity	10% ~ 90% RH, non-condensing	

# 3-2 TouchPAD Series: Touch HMI Devices



ICP DAS provides two types of touch HMI devices, the TPD series and the VPD series. The TPD series is designed for home/building automation applications and the VPD series is designed for factory/machine automation applications. Both series have features in common such as a high-resolution touch screen, RTC, and a variety of communication interfaces, RS-232/RS-485, Ethernet, and USB. However, each series has its own specific features for its respective target applications. For the TPD series, an external wall box is to help smoothly combine the TPD series device with your decoration. For the VPD series, rubber keypad, IP65 waterproof front panel and DIN Rail/panel mounting are designed for harsh environment, and are suitable for factories.

TPD Series    VPD Series



HMIWorks is a free development tool that can be used to design SoftPLC logic ladder diagrams for TouchPAD, meaning that a single TouchPAD becomes a touch HMI device running ladder logic.

## Applications

### Smart Home Automation

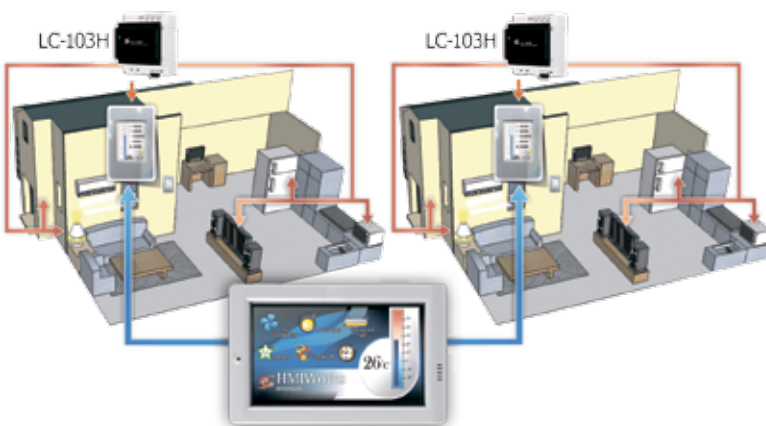

### Meeting Room Auto-management

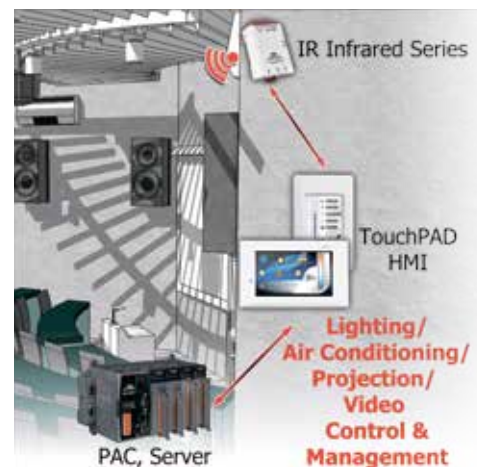



# TPD Series: High Speed Touch HMI Devices



## 2.8" TPD High Speed



**TPD-280-H    TPD-283-H    TPD-283U-H**



**TPD-280-M1    TPD-280-M2    TPD-280-M3  
 TPD-283-M1    TPD-283-M2    TPD-283-M3  
 TPD-283U-M1    TPD-283U-M2    TPD-283U-M3**

The **TPD Series** is a family of tiny touch HMI devices, that designed for building and home automation. The TPD 2.8" Series provides a full-color, high-resolution TFT touch screen, which matches a regular electrical wall-mount outlet. It seamlessly integrates a wide range of I/O modules and provided an attractive, flexible and customizable picture frame.



### Features

- High-resolution Color Touch Screen
- PoE (Power over Ethernet)
- RS-485 (Including Self-Tuner)
- RTC (Real Time Clock)
- GUI Design
- Modbus TCP/RTU Protocol
- DCON Protocol
- Free HMIWorks Development Tool
- Support C Language and Ladder Designer
- Support User-defined Third-party Protocols
- ESD Protection: 4 kV
- Operating Temperature: -20 to +70°C

### Applications



### TPD Series: 2.8" (Resolution: 240 x 320)

TPD Model	Extra Flash	Image Storage Capacity (1)	Ethernet	COM port	RTC	Installation	Power (2)
<b>TPD-280-H</b>	-	4	-	1x RS-485	-	Outlet Box: OB120	+12 ~ 48 VDC
<b>TPD-283-H</b>			Yes	-	-		PoE
<b>TPD-280U-H</b>	16 MB	108	-	1x RS-485	Yes	External Wall Box: EWB-T28	+12 ~ 48 VDC
<b>TPD-283U-H</b>	16 MB		Yes	1x RS-485			+12 ~ 48 VDC or PoE
<b>TPD-280-Mx</b>	-	4	-	1x RS-485	-	EWB-T28-BK	+12 ~ 48 VDC
<b>TPD-283-Mx</b>	-	4	Yes	-	-		PoE
<b>TPD-283U-Mx</b>	16 MB	108	Yes	1x RS-485	Yes		+12 ~ 48 VDC or PoE

(1) The Image Storage Capacity greatly depends on the content and the size of the images. The value indicated illustrates the maximum number of full-screen resolution images that can store on the device.

(2) Power Input: PoE (Power over Ethernet, IEEE 802.3af, Class 1, 48 V)

Product Series

## 4.3" TPD High Speed Touch HMI



### Features

- High-resolution Color touch screen
- Power over Ethernet (PoE)
- RS-485/RS-232
- RTC (Real Time Clock)
- Buzzer
- Graphical user interface designer
- Support Modbus RTU/TCP protocol
- Support DCON protocol
- Free development tool: HMIWorks
- Support C language and Ladder Designer
- Support user-defined third party protocol
- 7" Operating temperature: -10 ~ +60°C
- 4.3" Operating temperature: -20 ~ 50°C



**TPD-430-H**

**TPD-433-H**



**TPD-430-H-EU TPD-433-H-EU**



**TPD-432F-H**

**TPD-433F-H**

## 7" TPD High Speed Touch HMI

**TPD-703**  
**TPD-703-64**



### TPD Series & Resolution: 4.3" 480 x 272; 7" 800 x 480

TPD Model	LCD	Exp. Flash	Image (1) Storage Capacity	Ethernet	COM port	RTC	Installation	Power (2)			
<b>TPD-430-H</b>	4.3 Inch	16 MB	64	-	1 x RS-485	Yes	Outlet Box: OB120 External Wall Box: EWB-T43 EWB-T43-BK	+12 ~ 48 VDC			
<b>TPD-433-H</b>				Yes				+12 ~ 48 VDC or PoE			
<b>TPD-430-H-EU</b>				-			European Box: 86 x 86 mm	+12 ~ 48 VDC			
<b>TPD-433-H-EU</b>				Yes				+12 ~ 48 VDC or PoE			
<b>TPD-432F-H</b>				16 MB	64		-	2 x RS-485	Yes	Outlet Box: OB140F/OB140FP External Wall Box: EWB-T43F	+12 ~ 48 VDC
<b>TPD-433F-H</b>							Yes	1 x RS-232 1 x RS-485			+12 ~ 48 VDC or PoE
<b>TPD-433-M2</b>											
<b>TPD-703</b>	7 Inch	16 MB	18			Yes	1 x RS-232 1 x RS-485	Outlet Box: OB170 External Wall Box: EWB-T70			+12 ~ 48 VDC or PoE
<b>TPD-703-64</b>		64 MB	84								

(1) The Image Storage Capacity greatly depends on the content and the size of the images. The value indicated illustrates the maximum number of full-screen resolution images that can store on the device.

(2) Power Input: PoE (Power over Ethernet, IEEE 802.3af, Class 1, 48 V)



# VPD Series: Industrial High Speed Touch HMI Devices

## 3.5" VPD



**VPD-130-H**  
**VPD-132-H**  
**VPD-133-H**



**VPD-130N-H**  
**VPD-132N-H**  
**VPD-133N-H**

## 4.3" VPD



**VPD-142-H**  
**VPD-143-H**



**VPD-142N-H**  
**VPD-143N-H**



### Features

- High-resolution Color Touch Screen
- RTC (Real Time Clock)
- Serial/Ethernet Comm. Ports
- Support Modbus RTU/TCP protocol
- Rubber Keypad: 3.5"/4.3" N Model
- Graphical user interface designer
- Free development tool: HMIWorks
- Support C language and Ladder
- Support Modbus RTU/TCP protocol
- Support DCON protocol
- Support user-defined third party protocol
- Waterproof Front Panel: IP65
- I/O Expansion Boards (XV-Board)
- Operating temperature: -20 ~ +50°C

## 7" VPD



**VPD-173N**  
**VPD-173X**  
**VPD-173N-64**  
**VPD-173X-64**



The **VPD Series** is a series of industrial touch HMI devices with high-resolution color touch screen LCD. With touchscreen capability, it is easy to deploy into all kinds of automation systems and make them more intuitive and efficient. VPD series stands out for its wide variety of communication methods. Besides, the built-in non-volatile storage makes VPD series more reliable in rugged environments.

### VPD Series & Resolution: 3.5" 320 x 240; 4.3" 480 x 272; 7" 800 x 480

VPD Model	LCD	Exp. Flash	Image (1) Storage Capacity	COM port	Ethernet	RTC	Expansion I/O Board	Rubber Keypad	Ingress Protection	Power (2)
<b>VPD-130-H</b> <b>VPD-130N-H</b>	3.5"	16 MB	108	COM1: RS-232 RS-485	-	Yes	Yes	Yes, except the N model	Front Panel: IP65	+12 ~ 48 VDC
<b>VPD-132-H</b> <b>VPD-132N-H</b>				COM1: RS-485 or RS-232						
<b>VPD-133-H</b> <b>VPD-133N-H</b>				COM2: RS-485	Yes					+12 ~ 48 VDC or PoE
<b>VPD-142-H</b> <b>VPD-142N-H</b>	4.3"	16 MB	64	COM1: RS-485 or RS-232	-	Yes	Yes	Front Panel: IP65	+12 ~ 48 VDC	
<b>VPD-143-H</b> <b>VPD-143N-H</b>				COM2: RS-485 or RS-232						Yes
<b>VPD-173N</b> <b>VPD-173X</b>	7"	16 MB	18	COM1: RS-232 or RS-485	Yes	Yes	-	Front Panel: IP65	+12 ~ 48 VDC or PoE (48 V)	
<b>VPD-173N-64</b> <b>VPD-173X-64</b>		64 MB	84	COM2: RS-232 or RS-485			-			Yes

(1) The Image Storage Capacity greatly depends on the content and the size of the images. The value indicated illustrates the maximum number of full-screen resolution images that can store on the device.

(2) Power Input: PoE (Power over Ethernet, IEEE 802.3af, Class 1, 48 V)

Product Series

## 3-3 LC/SC/DALI Series: Smart Lighting Control



The smart lighting products, are generally designed for building automation, easy cabling, installation and setup. The LC and SC series support Modbus and DCON protocols; the DALI series is a DALI converter. According to the demands, user can control lighting with digital input directly or via RS-485 communication. The main applications are the group lighting control, dimmer scenes, electric curtains, HVAC, security and other automation controls. Customers can build a smart home/building automation system combine with the Hub and TouchPAD module.

### Features

- ▶ **Support Modbus RTU and DCON communication protocols**  
Support the industry standard Modbus protocol and the DCON string protocol for easy integrating the third-party devices.
- ▶ **Control via digital input and RS-485 communication**  
Provide two methods to control the Relay output: directly from the digital input, or via the RS-485 communication, or both.





# LC Series: Lighting Control Module

## Lighting Control / Dimmer Control



### LC-103H



### LC-223H



### Selection Guide



#### Lighting Control

Model	Relay Output			AC Digital Input			
	Ch.	Type	Max. Load Current	Ch.	Type	On Voltage Level	Off Voltage Level
LC-101H	1	Power Relay, Form C	NO: 16 A NC: 16 A	1	90 ~ 240 VAC	85 VAC	60 VAC
LC-103H	3	Power Relay, Form A	16 A	1	90 ~ 240 VAC	85 VAC	60 VAC



#### Lighting Control: Load Current Feedback Measurement

Model	Relay Output with Load Current Feedback			Analog Input		Digital Input	
	Ch.	Type	Range	Ch.	Range	Ch.	Range
LC-305	—	—	—	5	AC Load Current Input: 0 ~ 5A	—	—
LC-322H	2	Power Relay	Form A: 16A with AC Load Current Input: 0~5A	—	—	2	DI: 90~240VAC



#### Lighting Control: Dimmer

Model	Relay Output			Analog Output			Digital Input		
	Ch.	Type	Load Current	Ch.	Type	Resolution	Ch.	Type (VAC)	Voltage Level (VAC)
LC-223H	1	Power Relay, Form A	Max. 16 A	1	0 ~ 20 mA, 4 ~ 20 mA, 0 ~ 10 V 1 ~ 10 V	12-bit	1	90 ~ 240	ON:85 / OFF:45
							2	Dry Contact	ON: Close to AGND / OFF: Open



#### Lighting Control: Digital Dimmer (DALI Gateway)

Model	Input Channel	Output Channel	Connector	Other
DGW-521	1 X RS-485/RS-232 1 X USB (Virtual COM)	1 X DALI	2-pin Terminal Block	Built-in DALI power (DC 16 VDC ± 5%, max. current 250 mA)



#### Smart Control: FCU

Model	Relay Output			AC Digital Input		Thermistor Input	
	Ch.	Type	Load Current	Ch.	Type	Ch.	Temperature Range
SC-6104-W5	4	Power Relay, 4 Form C	NO: 20 A, NC: 16 A	1	90 ~ 240 VAC	1	-40°C ~ +80°C

**LC-103H** is an easy-to-use lighting control module that requires no special skills to install and operate, and no software is needed in order to control the DO channels. The auto-control and traditional real switches can coexist through this perfect solution to incorporate traditional switches into advanced automation control.



**LC-223H** provides two-stage brightness for dimmer control. When no one enters the detection range, the lamp will remain at the 10% brightness.

When people enters, the lights will switch to the brightness range from 10% to 100%. When people leave the area, the fixtures will return back to default 10% brightness.

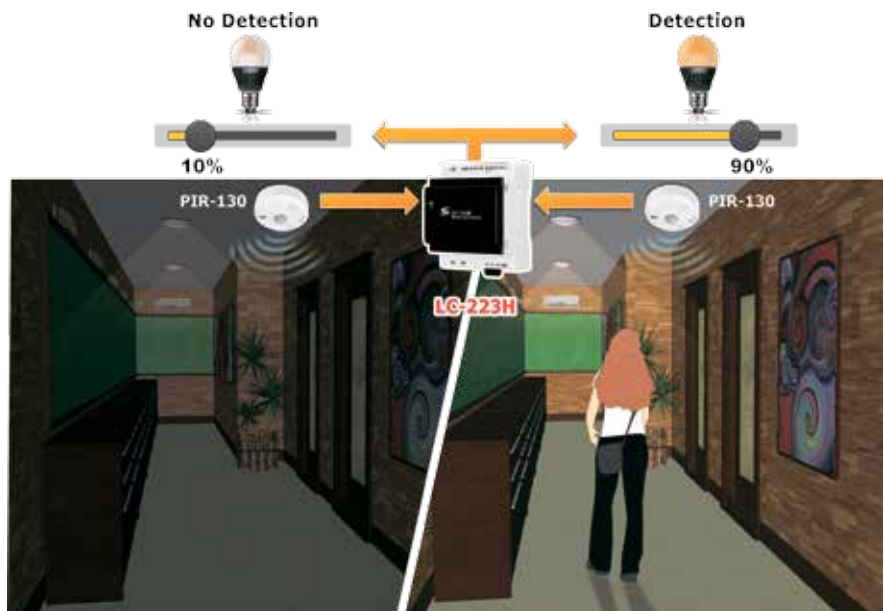

**LC-322H** is a 2-ch relay output loop with load current measurement module that provides the total current of all lamps on the control loop circuit and can use the relay to turn ON/OFF the current loop. In the lighting control application, the value of the load current feedback can help to know whether the equipment on the loop circuit is working well or fail, whether the ageing equipment needs to replace a new one, whether the relay is still sticky on, and so on.

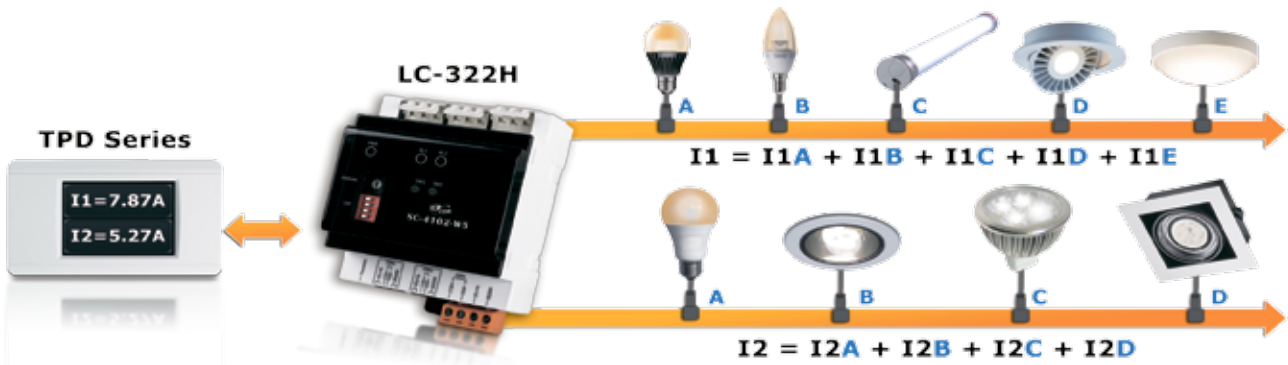

Product Series



# DALI Series

## Features



### DALI Gateway DGW-521



- Conversion between RS-485/RS-232/USB and DALI Interfaces
- Easy Deployment: ID Code can be written by the RS-485 Interface
- Simplified Wiring Process
- Built-in DALI Power can be enabled or disabled using a Switch
- 1500 VDC Isolation
- ±4 kV ESD Protection for the RS-232/485/USB Data Line
- DIN-Rail Mounting
- Wide Operating Temperature Range: -25 °C ~ +75 °C

**DGW-521** is a communication gateway between the Modbus RTU/DCON and the DALI (Digital Addressable Lighting Interface) protocols, and allows a Host PC, PAC, or TouchPAD to access DALI devices by providing three interfaces that enable conversion from RS-232/RS-485/USB to DALI. The module provides a built-in DALI power supply that can be enabled or disabled via a switch. DALI is an international standard for lighting control interfaces, and is suitable for DALI lighting systems covering small areas. The maximum length of the DALI signal cables cannot exceed 300 m.

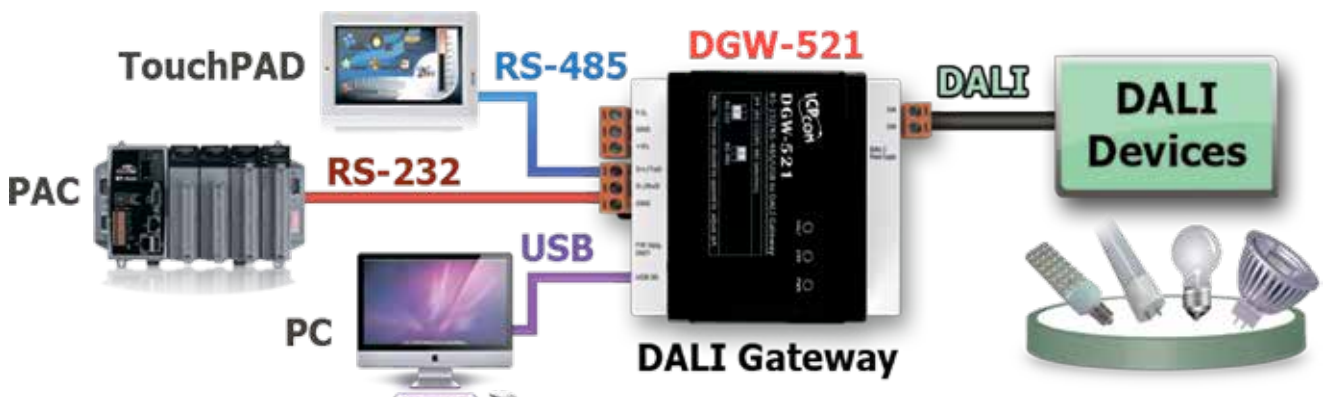
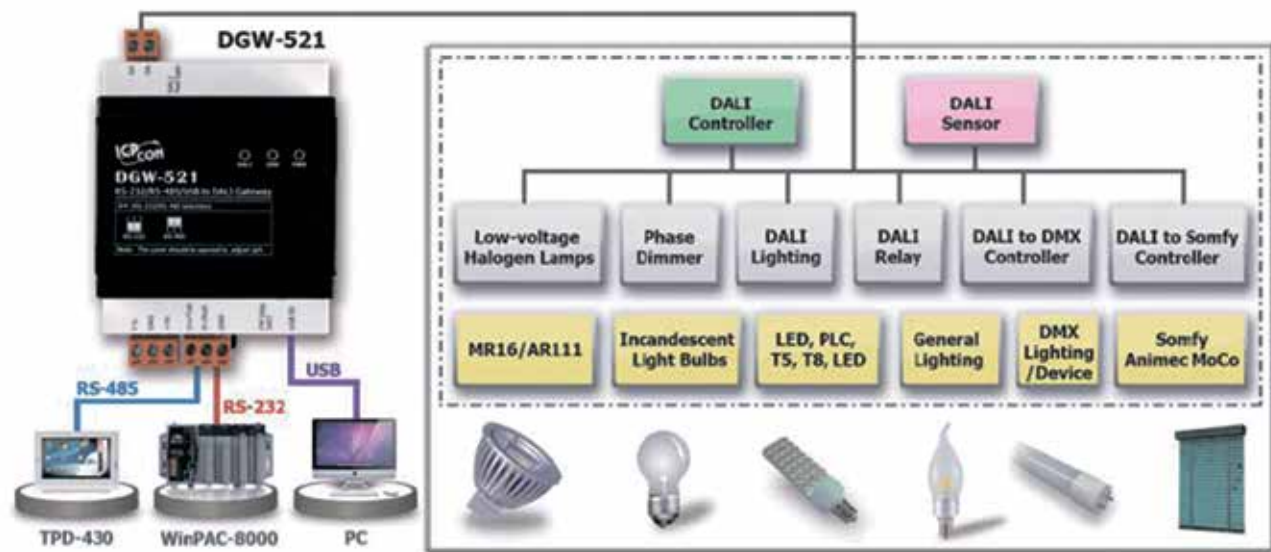

Product Series

# SC Series: Smart Control Multi-function Module



## FCU Control



**SC-6104-W5**

## Features

- Cost-effective for FCU control
- Power Relay Outputs
- Isolated AC Digital Input
- -40°C ~ +80°C Temperature Detector
- Support DCON and Modbus RTU Protocol
- 7 Kinds DI/DO coordinated functions

**SC-6104-W5** The SC-6104-W5 is an easy-to-use fan control module that requires no specialist skills to install and operate, and no software is needed in order to control the DO channels. The SC-6104-W5 provides 1 channel for digital input (photo couple isolation) and 4 channels for relay output. All of the 4 output channels are form C type relay, while the input channel is based on a sink-type using a wire connection. The input channel can directly control a 4-channel relay ON and OFF sequence without requiring a remote host controller. And the SC-6104-W5 support 7 kinds coordinated function for users select. In addition to there is one channel temperature sensor can detect -40°C ~ +80°C and it can be read by DCON and Modbus RTU communication protocol to control fan control unit. SC-6104-W5 has ±4 kV ESD protection for each terminal and 5000 Vrms intra-module isolation for DI. And the Shell is using fireproof materials.



## Three-speed Fan and Cold Water Valve Control System

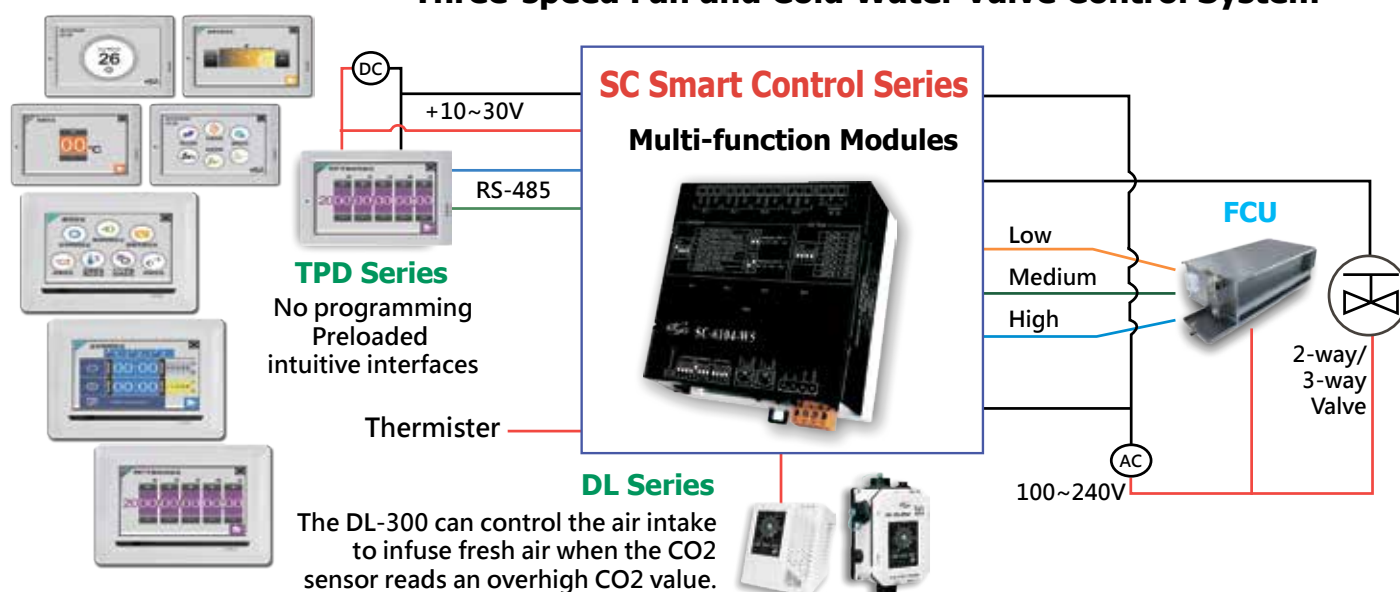



# 3-4 PM/PMC Series: Energy Management

## IIoT Power Meter Concentrator

### PMC Series



### PMD Series With Touch Panel



### PMC/PMD Features:

- No extra software tool is required, using browsers to perform system operations
- Support max. 24 ICP DAS Modbus Power Meters (with max. 16 Modbus TCP Power Meters) and 8 Modbus I/O modules.
  - \* COM3 and COM4 interface can connect to Max. 16 power meters individually.
  - \* Support at most 4 ICP DAS PM-4324 series Power Meters.
- Display real-time or historical power data; Provide power data statistics report
- Data file auto send-back & recovery when network is resumed after disconnection
- Built-in IF-THEN-ELSE logic engine for thought-out power demand management
- Provide alarm message notification function via LINE, Messenger, Email or SMS.
- Adjust device operations by its power status via Modbus I/O modules
- Provide Schedule function for operations of I/O modules (devices)
- Support Modbus TCP/RTU Slave protocol for seamless integration with SCADA
- Support SNMP and MQTT protocols
- Support Connection to IoT Cloud Platform (Microsoft Azure and IBM Bluemix); Support ICP DAS IoTstar Cloud software



### PMC Special Features:

- PMC-5231M-4GE/PMC-5231M-3GWA: Support 4G/3G Wireless data communication
- PMC-2241: Support 2 Ethernet Ports

### PMD Special Features:

- 7"/10.4" TFT LCD (with Touch Panel) & PoE (Power over Ethernet) supported
- Equipped with the TFT LCD (with Touch Panel) and designed for panel mount installation. Easily review the power data and system setting at the local side.

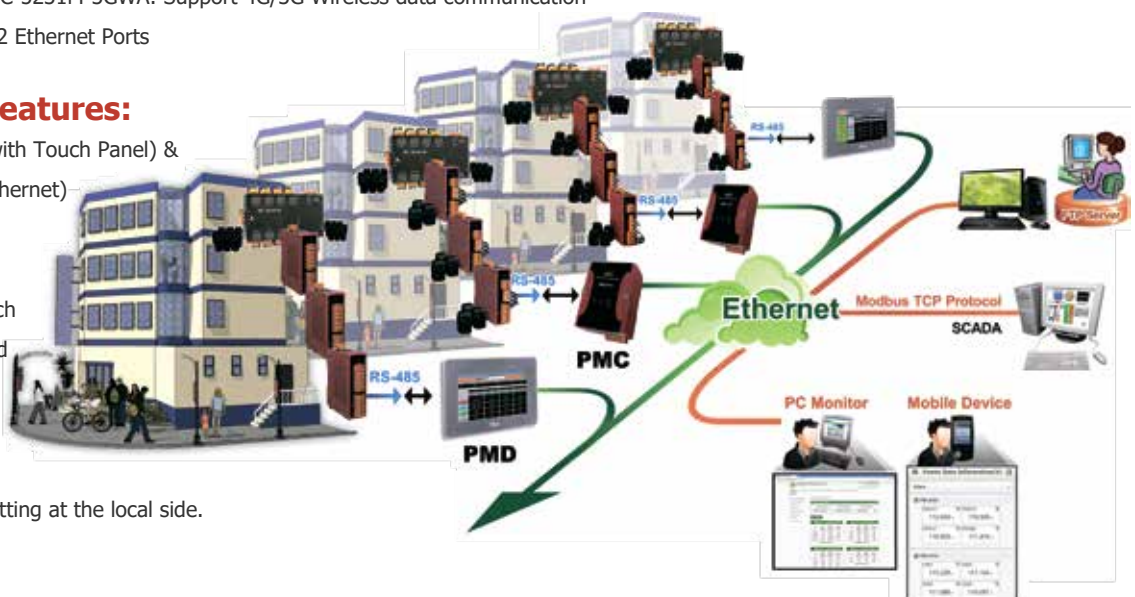

Smart Power Meter

PM Series

3P 1



PM-3033

3P 1



PM-3133

Isolated

3P 1



PM-3133i

1P 2



PM-3112

1P 4



PM-3114

Rogowski Coil

3P 1



PM-3133-RCT

LED Display

3P 8 1P 24



PM-4324D

3P 8 1P 24

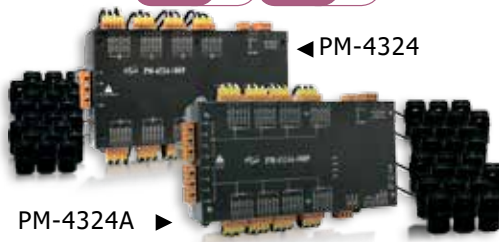

PM-4324 / PM-4324A

LED Display

3P 1



PM-2133D

- Support multiple communication interface:
  - RS-485 (Modbus RTU)
  - Ethernet (Modbus TCP)
  - CAN bus (CANopen)
- Bi-directional kWh metering function for accurate measurement of power consumption and generation data
- Compact in size and easy to install, suitable for various industrial sites
- Available with CT for accurate metering, accuracy better than 0.5% (PF=1)
- Clip-on CT for easy installation

Selection Guide

Module No.	Phase	Loop	+/- kWh	CT included	Max. Voltage	Max. Current	Max. CT ID	Cable Length
PM-3112-xxx	Single	2	N/A	Yes	300 V	200 A	24 mm	1.8m
PM-3114-xxx		4						
PM-2133D-xxxP	Three	1	Yes	Yes	500 V	400 A	36 mm	4m
PM-3033	Three	1	Yes	N/A	500 V	5 A	N/A	N/A
PM-3133-xxx	Three	1	Yes	Yes	500 V	400 A	36 mm	1.8m
PM-3133-xxxP					500 V			4m
PM-3133i-xxxP					600 V			4m
PM-3133-RCTxxxP	Three	1	N/A	Yes	500 V	2000 A	105 mm	4m
PM-4324-xxxP	Single/Three	24 / 8	Yes	Yes	500 V	400 A	36 mm	4m
PM-4324A-xxxP								
PM-4324D-xxxP								

\*Maximum CT cable length can be extend to **8m** (except for Rogowski Coil CT), and the accuracy does not decrease. [We suggest to use twisted pair cable AWG18-14, sectional area from 0.75 ~ 2.0mm<sup>2</sup>.]  
 \*\*The end of power meters with -xxx or -xxxP means the specification of the CT. Users can choose the suitable one based on difference of current range and cable section area.  
 \*\*\*The end of power meters with -xxxP, the P means CT has built-in circuit protection to prevent CT from secondary open-circuit danger to human.



## 3-5 CL Series: Smart Environmental Monitoring



Fine particulate matter (PM<sub>2.5</sub>), gas (CH<sub>4</sub>), HCHO, and CO affect health and safety of human. Monitoring the concentration of these fume and gas can prevent people from danger. High concentrations of CO<sub>2</sub> is always harmful to health, so data of CO<sub>2</sub> monitoring is a reference for indoor air quality. The **CL-200 series** can detect CH<sub>4</sub>, HCHO, PM<sub>2.5</sub>, CO, CO<sub>2</sub>, Humiture and Dew Point information. The Sensing Solution is suitable for the public area, commercial space, green building, smart buildings. A free Utility is included to configurate and display data in a powerful chart that can be exported to Excel format. CL series can connected with various communication interfaces, so that the device can be easily integrated into existing HMI or SCADA systems.

**CL-200** series can be used to record HCHO, CH<sub>4</sub>, PM<sub>2.5</sub>, CO, CO<sub>2</sub>, Temperature, Humidity and Dew Point information, including date and time stamps, and can store up to 450,000 downloadable records. Real-time data can be accessed from the free Utility from anywhere and anytime using the free Windows software.



- Transportation of Food or Pharmaceuticals
- Food and Beverage Industry (HACCP)
- Blood Stations and Pharmacies
- Building and Energy Management
- Warehouse Management
- Museums, Archives and Galleries

CH<sub>4</sub> methane (the main element of natural gas, different from the liquid petroleum gas) gas detector provides an early residential warning of the presence of explosive methane and is factory calibrated to sound an alarm that meets UL1484 standard.

Formaldehyde (HCHO) is one of the volatile organic compounds (VOCs) that widely used in household materials, be a binder precursor, which associated with many health risk factors. At concentrations above 0.1 ppm in air formaldehyde can irritate the eyes, resulting in watery eyes. The HCHO detector also provides an instantaneously warning of toxic formaldehyde.

### Free and Powerful Utility Software

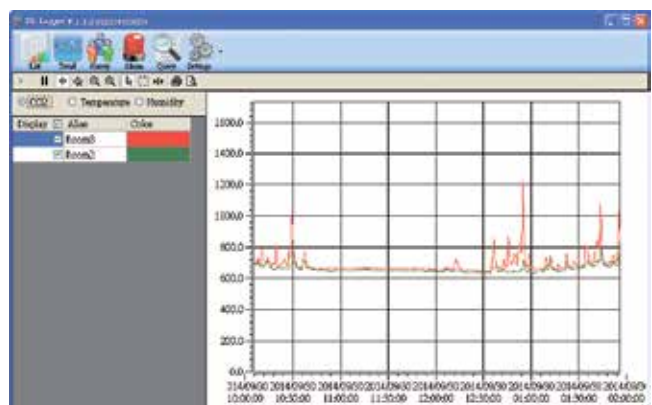

**CL Series: Industrial Environmental Sensor**

**CL-200 Series: PM2.5 / Fumes / Humiture Monitoring**

**CL-2** X X - X



**CL-200 Series**

**Particle Matter Sensor**

- 1 : PM2.5
- 2 : PM2.5/1/10 + Particle

\* PM Sizes:  
0.3µm, 0.5µm,  
1µm, 2.5µm,  
5µm, 10µm

**Types of Fume Sensor**

- 1 : CO
- 2 : CO2
- 3 : CO+CO2
- 4 : HCHO + TVOC
- 5 : NH3
- 6 : H2S
- 7 : HCHO
- 8 : TVOC
- 9 : Comprehensive

**Communication**

- E : Ethernet/PoE
- BLE : Bluetooth
- WF : Wi-Fi

Sensor	Range and Descriptions
CO	0 ~ 1000 ppm
CO2	0 ~ 9999 ppm (NDIR)
HCHO	0 ~ 2000 ppb
TVOC	0 ~ 60000 ppb (MEMS)
NH3	0 ~ 100 ppm

Sensor	Range and Descriptions
H2S	0 ~ 100 ppm
CH4	500 ~ 7000 ppm
PM2.5	0 ~ 400 µg/m3; Resolution: 1µg/m3
Temperature	-10°C ~ 50°C / Accuracy: ±0.6°C
Humidity	0 ~ 100 % RH / Accuracy: ±5% RH

Models			Accessory	Sensor Type					
Ethernet/PoE	Bluetooth	Wi-Fi	Filter	Particulate Matter	Fumes	Humiture			
CL-201-E	CL-201-BLE	CL-201-WF	-	-	CO	Temp. RH			
CL-202-E	CL-202-BLE	CL-202-WF			CO2				
CL-203-E	CL-203-BLE	CL-203-WF			CO + CO2				
CL-204-E	CL-204-BLE	CL-204-WF			HCHO + TVOC				
CL-205-E	CL-205-BLE	CL-205-WF			NH3				
CL-206-E	CL-206-BLE	CL-206-WF			H2S				
CL-207-E	CL-207-BLE	CL-207-WF			HCHO				
CL-208-E	CL-208-BLE	CL-208-WF			TVOC				
CL-210-E	CL-210-BLE	CL-210-WF			Replaceable Filter		PM2.5	-	Temp. RH
CL-211-E	CL-211-BLE	CL-211-WF						CO	
CL-212-E	CL-212-BLE	CL-212-WF	CO2						
CL-213-E	CL-213-BLE	CL-213-WF	CO + CO2						
CL-220-E	CL-220-BLE	CL-220-WF	Replaceable Filter	(PM Sizes: 0.3µm, 0.5µm, 1µm, 2.5µm, 5µm, 10µm)	-	Temp. RH			
CL-221-E	CL-221-BLE	CL-221-WF			CO				
CL-222-E	CL-222-BLE	CL-222-WF			CO2				
CL-223-E	CL-223-BLE	CL-223-WF			CO + CO2				
CL-224-E	CL-224-BLE	CL-224-WF			HCHO + TVOC				
CL-225-E	CL-225-BLE	CL-225-WF			NH3				
CL-226-E	CL-226-BLE	CL-226-WF			H2S				
CL-227-E	CL-227-BLE	CL-227-WF			HCHO				
CL-228-E	CL-228-BLE	CL-228-WF			TVOC				
CL-229-E	CL-229-BLE	CL-229-WF			CO + CO2 + HCHO + TVOC				

\*All modules have RS-485 Interface

Product Series

## Installation: CL-200 Series

### Ceiling Mounting

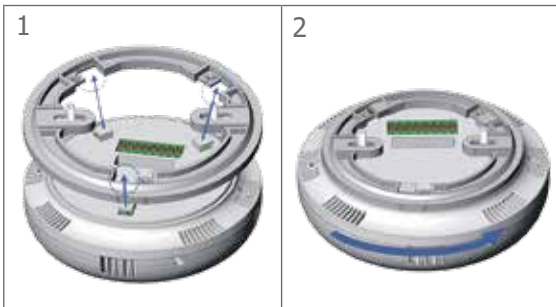

### Wall Mounting (+ External Wall Box EWB-C150)

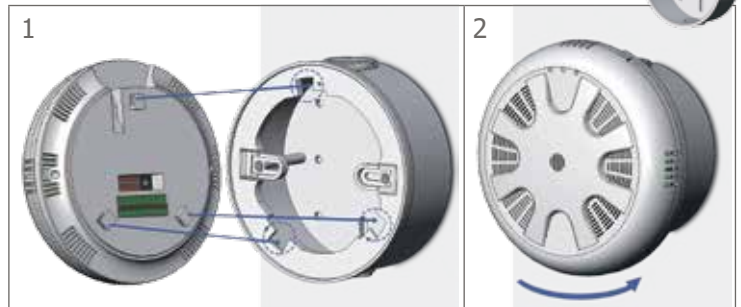

## Installation: Filter

### Replaceable Filter Patch:

CL-21x Series offers a replaceable filter patch on the back of the hood filter. This mechanism makes users to replace only the filter patch rather than uninstall all devices.

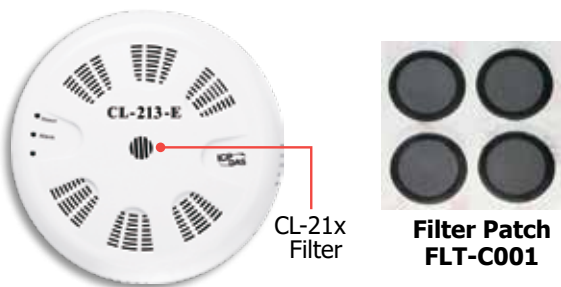

### CL-2xx-E + RJ45 Cable:

CL-2xx-E (Ethernet Type) are with optional angle-bent RJ45 cable to smoothly install the Ethernet plug in the hole of the ceiling-mounted.

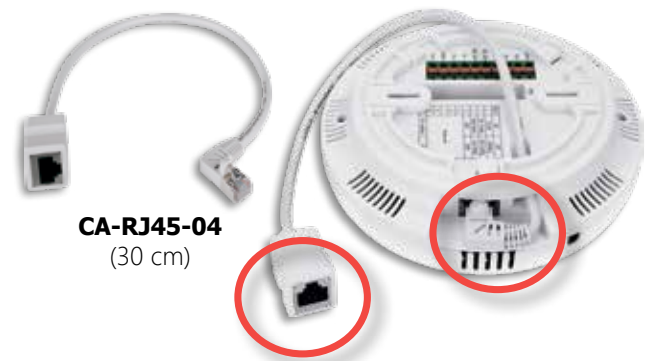

## Applications

### HCHO (Formaldehyde) Detector Automatic Solution

The **HCHO** detector provides an instantaneously warning of toxic formaldehyde, which can be commonly found in a plywood factory, furniture factory and new interior remodelling house.

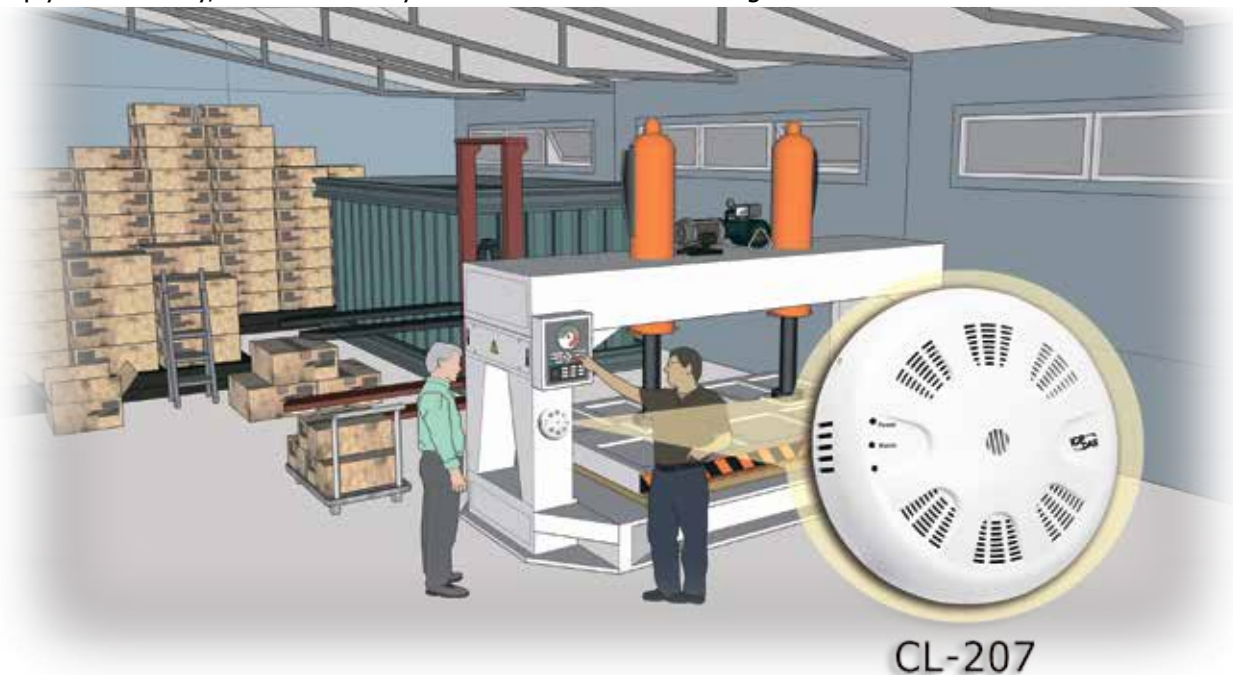



### Indoor or Underground Parking Lot Automatic Monitoring Solution

The air quality automation system for indoor or underground parking lot can use the CL-200 series modules to monitor the health and safety information, such as PM2.5, CO, CO2, temperature, humidity, dew point, and etc...

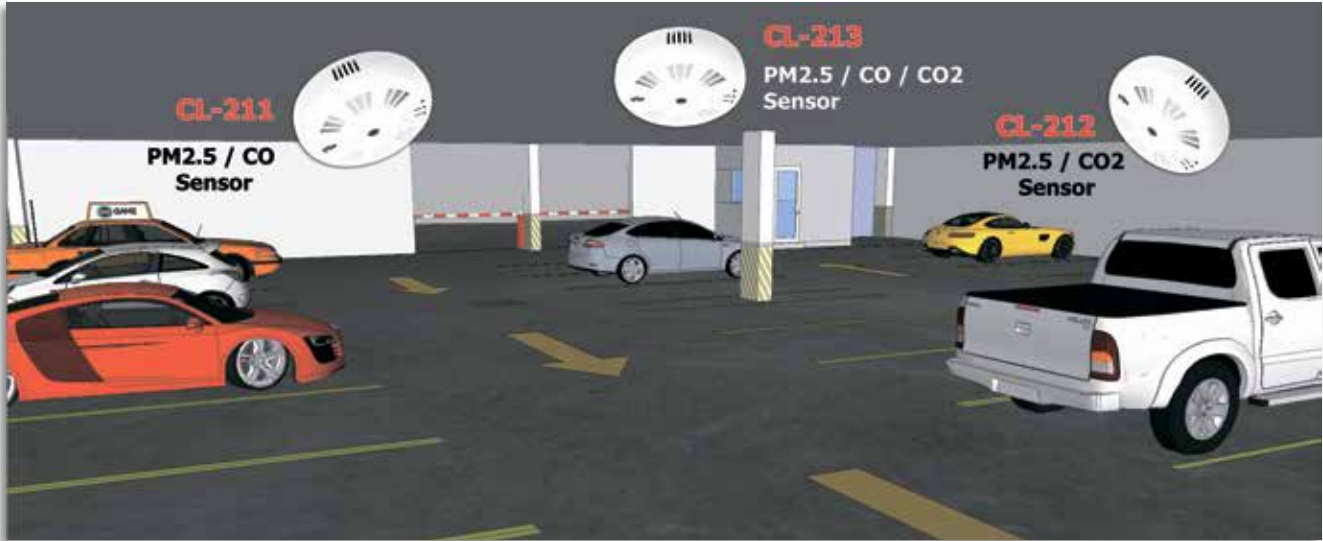

### Preschool Air Quality Monitoring

Indoor air quality is a key matter for children in preschool. ICP DAS provide a solution toward this environment include CL-213-E, CL-204-E modules to monitor the fumes and Particle Matters such as PM1, PM2.5, PM10, CO, CO2, HCHO, TVOC, and etc. Combine with ICP DAS iKAN series LED monitors, teachers in the preschool can easily check the real-time Air Quality Index. Furthermore, diversity of SCADA software is also compatible with these monitoring modules and can upload received data into remote database. Teachers can use their mobile App to remotely check the AQI or other fumes data to make sure that the Air Quality is always in the safety range.

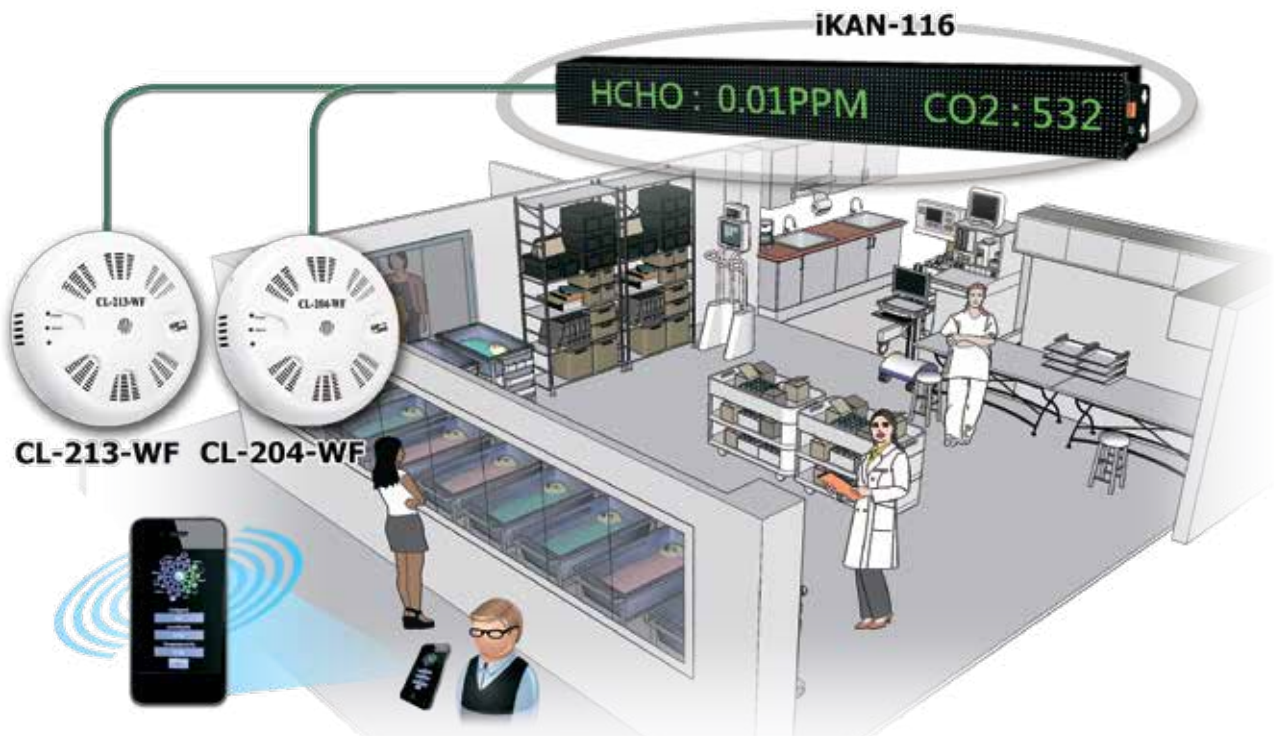

# 3-6 DL Series: Smart Environmental Monitoring

## CO / CO<sub>2</sub> / HCHO / NH<sub>3</sub> / H<sub>2</sub>S / TVOC / Temperature / Humidity / Dew Point

**4 Communication Interface Options**

- Ethernet
- RS-485
- Wi-Fi
- BLE

**DL-302-IP65** **DL-100**

**DL-100** **DL-300** **DL-1000**

**Greenhouse Automation**

DL series Data Logger provides RS-485, Ethernet/PoE, WiFi and Bluetooth communication interfaces for intelligent environment monitoring.

**DL-300 Series** monitors and records data of CO, CO<sub>2</sub>, HCHO, temperature, relative humidity and dew point. It can record up to 450,000 sets of data with time and date stamps. You can also download the iAir App, both iOS and Android supported, into smart phones and tablets to download the historical records. Furthermore, by using the free software for DL-300 series which can be run in the Windows Operating System, users can easily analyze and get the reports while DL-300 series are connected to the same local network.

**DL-100 Series** is a temperature and humidity data logger module that includes an RS-485, Ethernet/PoE communication interface and LCD display. It can store up to 4088 temperature and humidity records. DL-100 series provide free utility to install, configure, retrieve and display data records, and export the data into Excel format. These modules are suitable in luxury houses, villas, public facilities, business areas, smart buildings, and etc.

**DL-1000 Series** is a Particle Matter measurement module that gets the concentration of aerosols like PM<sub>2.5</sub>, PM<sub>1</sub>, PM<sub>10</sub> and the number of particles (0.3 $\mu$ m, 0.5 $\mu$ m, 1 $\mu$ m, 2.5 $\mu$ m, 5 $\mu$ m, 10 $\mu$ m). In addition, this series can measure various fume concentrations related to human health, such as: CO / CO<sub>2</sub> / HCHO / NH<sub>3</sub> / H<sub>2</sub>S / TVOC. It can also send alarms and record data. Furthermore, a replaceable hood filter is added in the mechanism. A customized dust filter patch is equipped in the back of the hood filter. Customers can replace the dust filter patch with no fail.

Designed for industrial applications in harsh environments, the **IP65 version of DL series** is IP65 rated for protection against water and dust. Use a rugged RJ-45 to ensure a tight and strong connection, it can improve the reliability of operation even in applications with high vibration and high impact.



## DL Series: Industrial Data Logger

DL Series supports popular industrial protocols such as DCON, Modbus RTU, and Modbus TCP, as well as the emerging machine-to-machine (M2M) / IoT (Internet of Things) connectivity protocol – MQTT. The DL-300 Data Logger can connect with communication interfaces including RS-485, Ethernet and PoE, so the device can integrate easily into existing HMI or SCADA systems, and its easy to maintain in a distributed control system.

### Large 2.8" LCD Touch Screen, with clear Color Chart to indicate the CO/CO2 Level

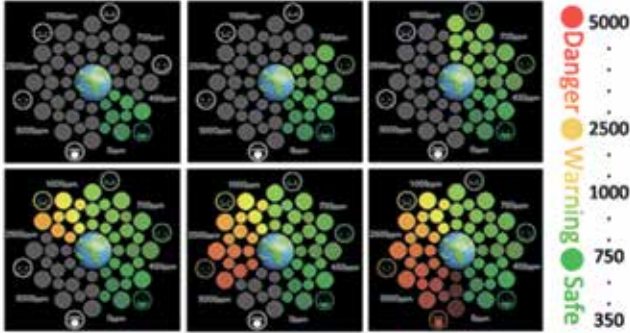

### Free and Powerful Utility Software

DL-300 Utility can be used to configure the modules, monitor real-time data, group DL-300 modules so that the status of groups can be viewed and managed. The utility can download the log data and exported to a .CSV format that can be imported into any industry-standard software or spread sheet for analysis.

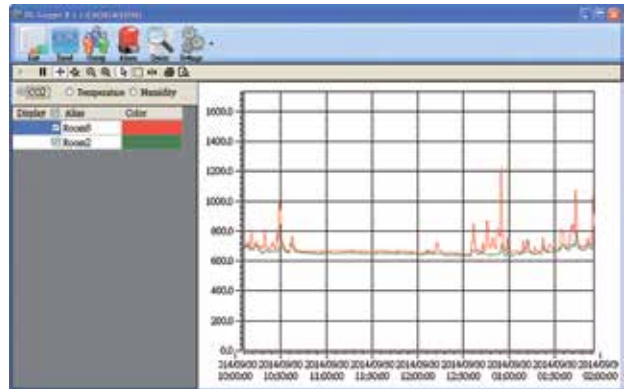

### Supports MQTT Protocol for IoT Applications

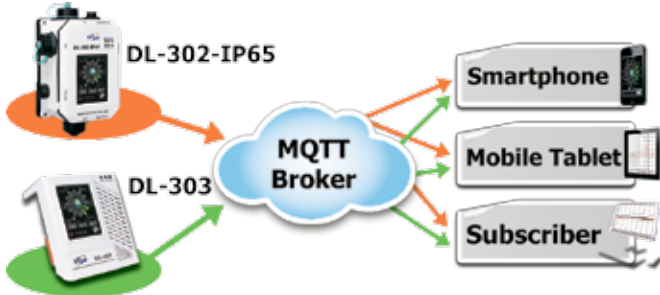

### Multi-platform Remote Access Software

Real-time data from the DL-300 Data Logger can be accessed from anywhere and at any time using the DL-300 Utility, the iOS or Android App, or via a regular web browser, as long as they are connected to the same local network as the Data Logger.

### Display Messages in Multiple Languages

The display-message-on-screen function supports multiple language character sets based on UTF-8 encoding. Users can remotely display either pre-configured messages or dynamic messages to prompt an operator with a daily schedule or IAQ device control instructions.



### Real-time data from the DL-300-WF series can be accessed from anywhere and at any time using the WF-IIOT-Utility and iOS App.



▲ iOS APP QR CODE



▲ Android APP QR CODE



**CO / CO2 / HCHO / TVOC / NH3 / H2S / Temperature / Humidity**



**DL-300**



**DL-300-IP65**



**DL-1000**

**Temperature / Humidity / illumination**



**DL-10**



**DL-100**



**DL-110**

**DL Series Sensing Function Selection Guide**

Series No.	DL-10	DL-100	DL-110/120	DL-300/DL-300-IP65	DL-1000
Types of Sensor	—	—	illumination	CO / CO2 / HCHO / TVOC / NH3 / H2S	
	Temperature / RH			Temperature / RH	
CO				0 ~ 1000 ppm	0 ~ 1000 ppm
CO2				0 ~ 9999 ppm (NDIR)	0 ~ 9999 ppm (NDIR)
HCHO	—		—	0 ~ 2000 ppb	0 ~ 2000 ppb
TVOC				0 ~ 60000 ppb	0 ~ 60000 ppb
NH3				0 ~ 100 ppm	0 ~ 100 ppm
H2S				0 ~ 100 ppm	0 ~ 100 ppm
Particle	—		—	—	PM1, PM2.5, PM10, Particle (Particle No.: 0.3µm, 0.5µm, 1µm, 2.5µm, 5µm, 10µm)
illumination	—	—	0 ~ 100,000 Lux	—	—
Temperature Range / Accuracy	R: -20°C ~ +60°C A: ±0.4°C	R: -20°C ~ +60°C A: max. ±0.3°C		Range: 0°C ~ 50°C ( IP65 support -20°C ~ 50°C ) Accuracy: ±0.6°C / Resolution: 0.1°C	
RH Range / Accuracy	R: 10 ~ 95% RH A: ±3% RH	R: 0 ~ 100% RH A: max. ±1.8% RH		Range: 0 ~ 100% RH Accuracy: ±5% RH / Resolution: 0.1% RH	
Dew Point	—	Range: ratio of Temperature to RH / Resolution: 0.1°C			
Data Logger	—	up to 4088 records		up to 450,000 records	
IP Rate	—	IP66		for module name with IP65	IP43
Display Screen	—	Monochrome LCD		2.8" TFT full-color touch LCD	—
Communication	Modbus RTU	RS-485 / ZigBee / Ethernet / PoE DCON or Modbus RTU		RS-485 / Ethernet / PoE / BLE / WiFi DCON, Modbus RTU, Modbus TCP, MQTT	
Advantage	Small-sized	IP66 rated		Support MQTT, Mobile Apps, Safety Alarm, IP65 rated	

Product Series

**Selection Guide**

DL-10/DL-100 Series: Temperature / Humidity								
Series/Model		Sensor		DO x 2	Interface	Protocol	Cover Color	IP Code
		T.	RH					
DL-10	DL-10	Yes	Accuracy 3%RH	-	RS-485	Modbus RTU	White	-
	DL-10-BK						Black	
DL-100	DL-100T485	Yes	Accuracy 3% RH	-	RS-485	DCON	Black	IP66
	DL-100T485-W						White	
	DL-100TM485					Black		
	DL-100TM485-W					White		
	DL-100T485P	Accuracy 1.8% RH	Black					
	DL-100T485P-W		White					
	DL-100TM485P		Black					
DL-100TM485P-W	White							
DL-101	DL-101-E	Yes	Accuracy 3% RH	Yes	Ethernet /PoE	Modbus TCP, MQTT	Black	
	DL-101-E-W						White	

**Appearance**

DL-100T485P-W



DL-100-E-W

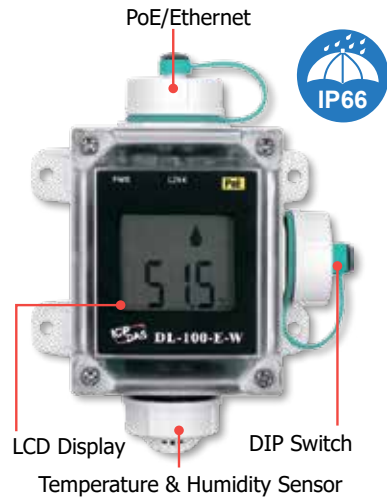

DL-101-E-W

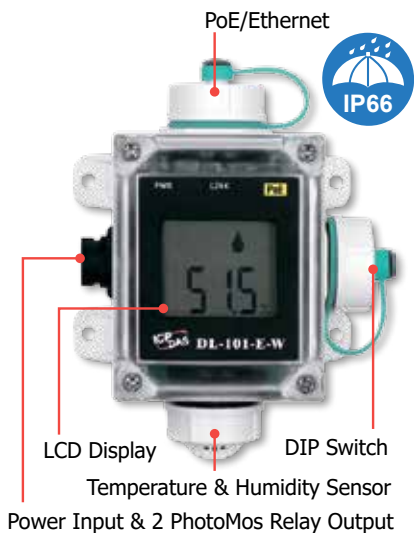

DL-10/ DL-10-BK

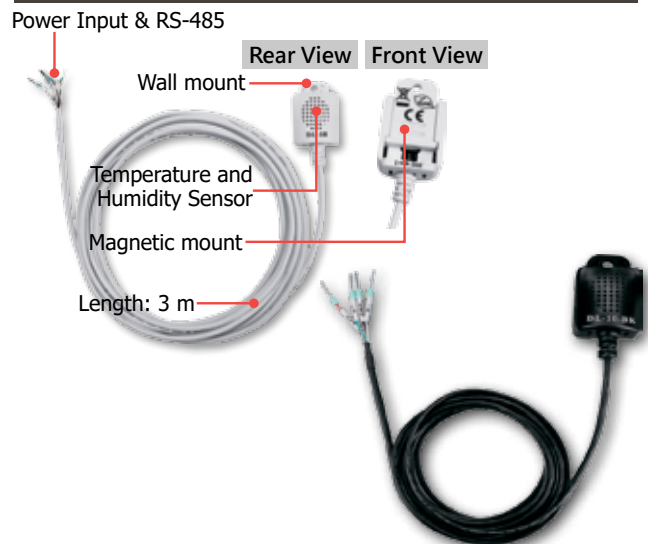

Product Series

## Selection Guide

Series/Model			Sensor				Interface	Cover Color	IP Code
			T.	RH	Lux	Range			
Out-door	DL-110	DL-110-E	Yes	Accuracy 3% RH	Yes	0-100,000 (Lux)	RS-485/ Ethernet/ PoE	Black White Black White	IP65
		DL-110-E-W							
	DL-120	DL-120-E	-	-	-	-			
		DL-120-E-W							
In-door	iSN-201	iSN-201-E	Yes	Accuracy 3% RH	Yes	0-20,000 (Lux)	RS-485/ Ethernet/ PoE	White	IP20
		iSN-201-BLE					RS-485/ Ethernet/ PoE/ Bluetooth		
		iSN-201-WF					RS-485/ Ethernet/ PoE/Wi-Fi		

## Appearance

DL-110-E

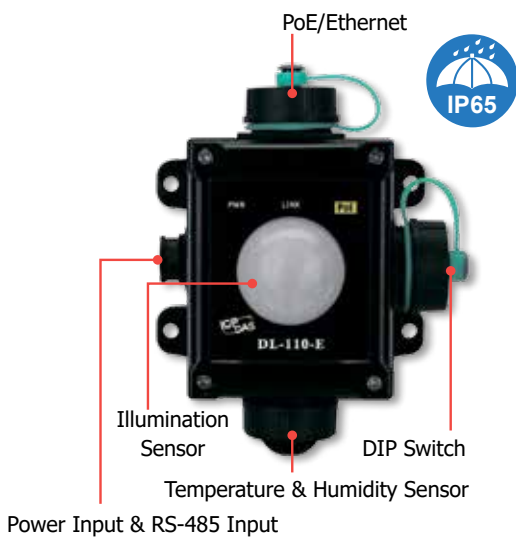

DL-110-E-W

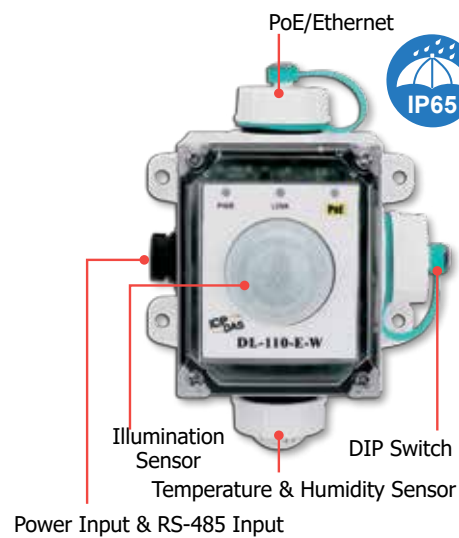

iSN-201-E

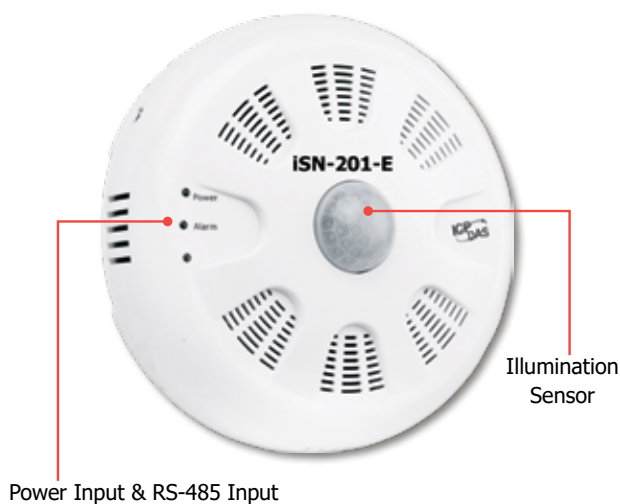

DL-120-E-W

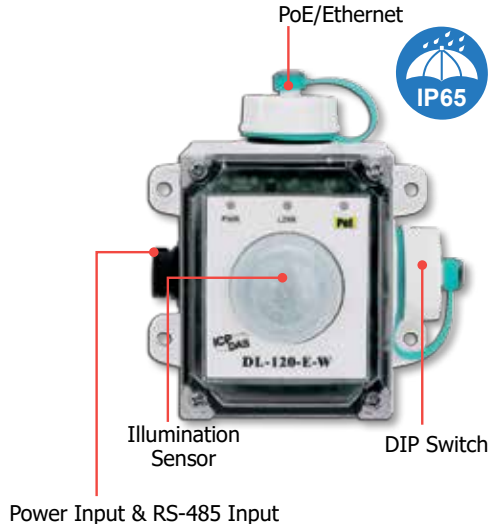



**DL-300 Series:**

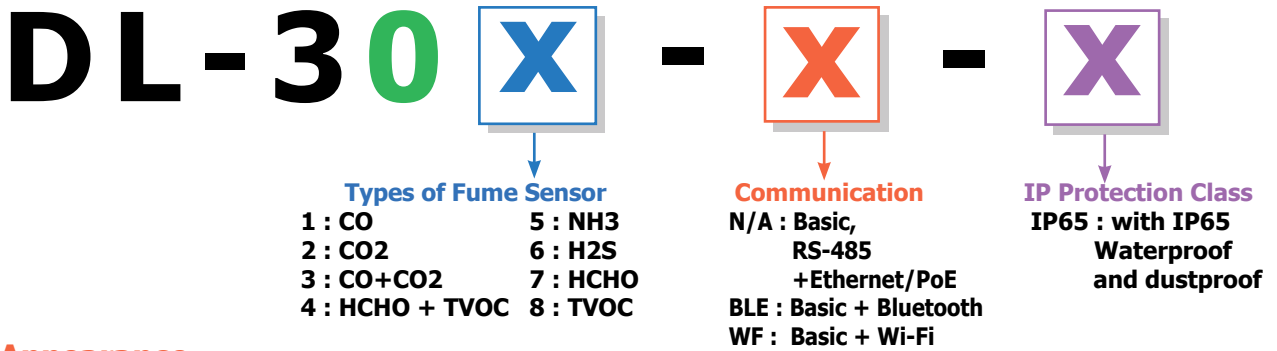

**Appearance**

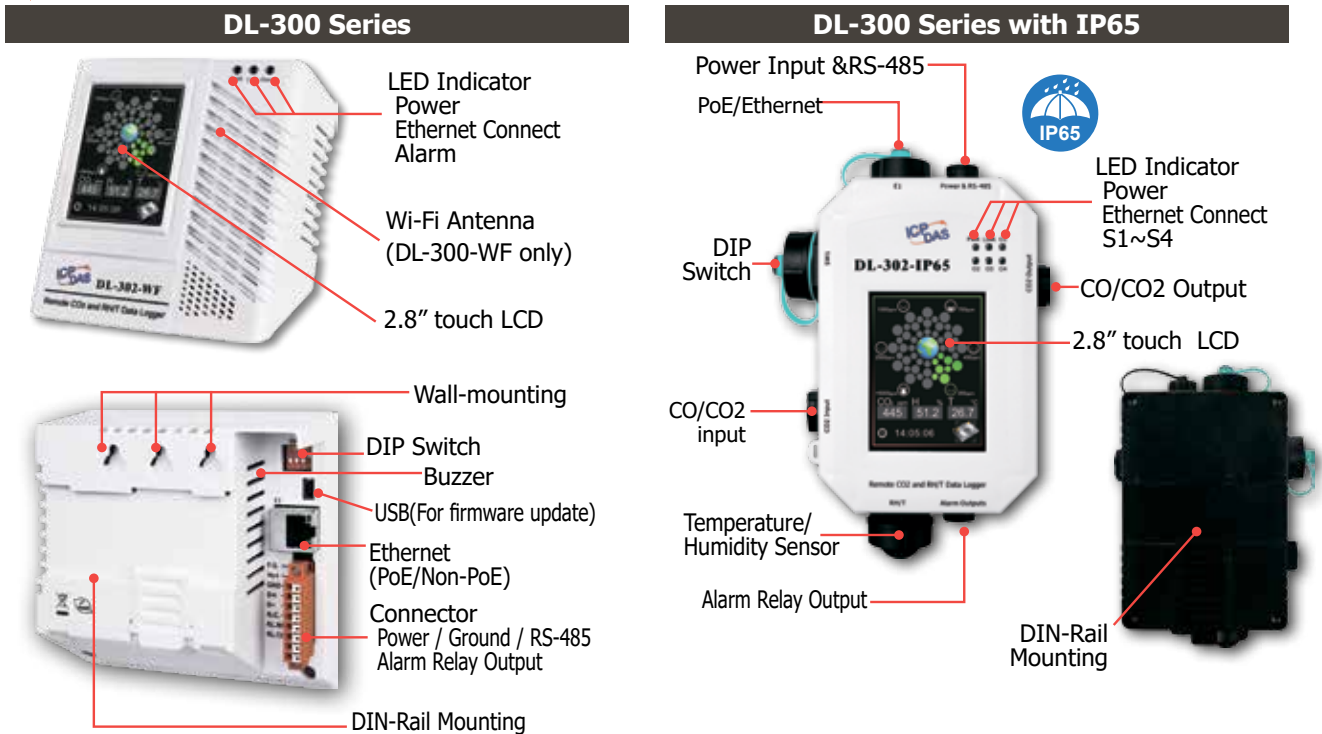

**Selection Guide**

DL-300 Series				Type of Sensor		Communication	IP Code
Series	Basic Type	Bluetooth	Wi-Fi	Fume Sensor	Humiture		
DL-301	DL-301	DL-301-BLE	DL-301-WF	CO	Yes	Basic type: RS-485 + Ethernet/PoE	-
	DL-301-IP65	DL-301-BLE-IP65	DL-301-WF-IP65				IP65
DL-302	DL-302	DL-302-BLE	DL-302-WF	CO2			-
	DL-302-IP65	DL-302-BLE-IP65	DL-302-WF-IP65				IP65
DL-303	DL-303	DL-303-BLE	DL-303-WF	CO + CO2			-
	DL-303-IP65	DL-303-BLE-IP65	DL-303-WF-IP65				IP65
DL-304	DL-304	DL-304-BLE	DL-304-WF	HCHO + TVOC			-
	DL-304-IP65	DL-304-BLE-IP65	DL-304-WF-IP65				IP65
DL-305	DL-305	DL-305-BLE	DL-305-WF	NH3	Basic + Bluetooth	-	
	DL-305-IP65	DL-305-BLE-IP65	DL-305-WF-IP65		IP65		
DL-306	DL-306	DL-306-BLE	DL-306-WF	H2S	Basic + Wi-Fi	-	
	DL-306-IP65	DL-306-BLE-IP65	DL-306-WF-IP65			IP65	
DL-307	DL-307	DL-307-BLE	DL-307-WF	HCHO	-		
	DL-307-IP65	DL-307-BLE-IP65	DL-307-WF-IP65		IP65		
DL-308	DL-308	DL-308-BLE	DL-308-WF	TVOC	-		
	DL-308-IP65	DL-308-BLE-IP65	DL-308-WF-IP65		IP65		

Product Series

## Applications

### •Mushroom Farming Solution

When talking about mushroom cultivation, the choice of a suitable place is the very important task. Mushrooms are very fragile in nature, so do not need too much sunlight. A temperature ranging between 18°C to 35°C is considered as the ideal one & favorable for mushroom farming. Also, a good moisture level is more beneficial in enhancing the good development of mushrooms. For this, humidity of 85 to 90 % of air should be maintained. The general equipment cannot work in such environment, but the DL-302-IP65 can be implement in this mushroom farming to record CO<sub>2</sub>, temperature and humidity information. By the way, WISE-5231M-4GE here is a controller with built-in logic control to receive and send SMS messages when there is something wrong.

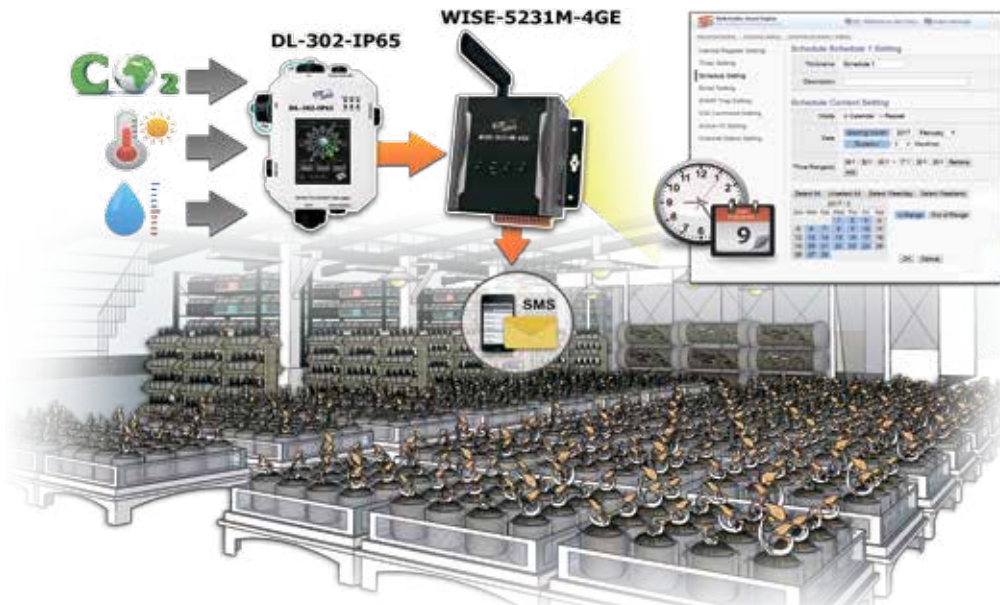

### •Pig Farming Solution

Pigs have one of highest rates of reproduction in animals, and they also grow very fast. To ensure a comfort environment for pigs to grow, normally in the pig pen would have pool, ventilation fans, sprinklers and drainage. Because of the smell your piggery would generate, using DL-305-IP65 in such farming can monitor the concentration of Ammonia, which is harmful gas in the pig farming and is bad to your piggery. Furthermore, pigs loves clean area so they need the sprinklers to have daily clean. DL-305-IP65 have IP65 water-proof sensor which works perfectly in the environment to monitor the humidity in the pig pen. The logic controller WISE-5231M-4GE allow user to schedule the specific logic control and also can send alarm to show failure events.





### ●HCHO (Formaldehyde) Detector Automatic Solution

The DL-307 is a 1-ch HCHO detector with data logger that provides an instantaneously warning of toxic formaldehyde, which can be found in a plywood factory, furniture factory and new interior remodelling house commonly. Real-time data can be accessed from the DL-307 from anywhere and at any time using the free Windows software, the iOS App or the Android App.



### ●Greenhouse Monitoring Solution

The greenhouse monitoring solution include WISE-5231M-4GE, DL-110-E and DL-300/DL-100 series. It provide the environmental monitoring operation for illuminance, temperature and humidity. Based on the built-in intelligent logic engine of WISE, the solution can automatically control the operation of sprinkler, lamp and curtain to help the plants grow well, increase crop yield and improve quality.

Based on the functions provided by WISE-5231M-4GE with iCAM series network camera, it can perform the personnel access control operation for greenhouse, and send the alarm message by SMS, Email, LINE to the related personnel for the emergency event notification. WISE can connect with the IoTstar cloud management software to help user to build the IoT cloud solutions in a easy way, and monitor the situation of the greenhouse remotely.



Product Series



**DL-1000 Series:**

# DL-10

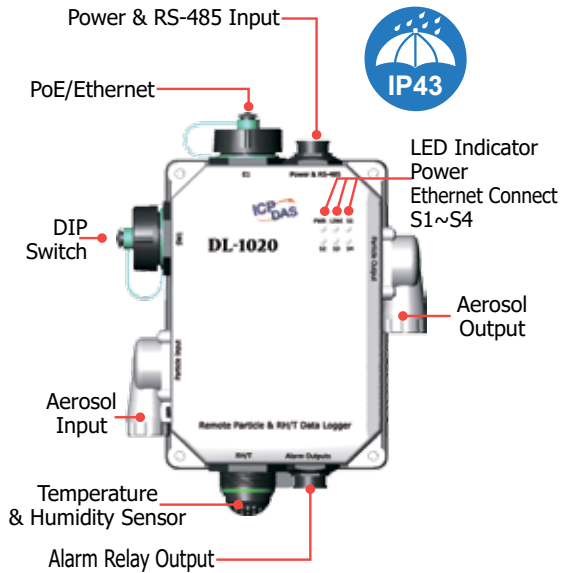

**Particle Matter Sensor**  
**1 : PM2.5**  
**2 : PM2.5/1/10 + Particle**  
 \* **PM Sizes:**  
**0.3µm, 0.5µm, 1µm, 2.5µm, 5µm, 10µm**

**Types of Fume Sensor**  
**0 : Particle**  
**1 : CO**  
**2 : CO2**  
**3 : CO+CO2**  
**4 : HCHO+TVOC**  
**5 : NH3**  
**6 : H2S**  
**7 : HCHO**  
**8 : TVOC**

**Communication**  
**E : Ethernet/PoE**  
**BLE : Bluetooth**  
**WF : Wi-Fi**

● **Dust Filter Hood**

DL-1000 series equip with two filter hoods. In the back side of the filter hood, ICP DAS provide a customized patch for the hood. This special mechanism design is good for users to replace the patch only.

● **Particle Matter & Fume Detector**

DL-1000 is a series of Particle gas measurement module that can measure the concentration of aerosols in the air, such as: PM2.5, PM1, PM10 and the number of particles (0.3µm, 0.5µm, 1µm, 2.5µm, 5µm, 10µm). In addition, various fume concentrations related to human health can also be measured. For example: CO/CO2/HCHO/NH3/H2S/TVOC. DL-1000 can record data and send alarm when concentration is too high.

● **Differences of DL-1000 and DL-300-IP65**

- Differences between DL-1000 and DL-300-IP65:
- DL-1000 add the function to measure PM1, PM2.5, PM10, and Particle in the air.
  - DL-300-IP65 has a 2.8-inch screen, but DL-1000 doesn't.
  - DL-300-IP65 has IP65 waterproof, DL-1000 doesn't.



**Selection Guide**

DL-1000 Series			Type of Sensor			Communication
Basic Type	Bluetooth	Wi-Fi	Particle	Fume Sensor	Humiture	
DL-1020	DL-1020-BLE	DL-1020-WF		—	Yes	Basic type: RS-485 + Ethernet/PoE  BLE type : Basic + Bluetooth  WF type: Basic + Wi-Fi
DL-1021	DL-1021-BLE	DL-1021-WF	PM1	CO		
DL-1022	DL-1022-BLE	DL-1022-WF	PM2.5	CO2		
DL-1023	DL-1023-BLE	DL-1023-WF	PM10	CO + CO2		
DL-1024	DL-1024-BLE	DL-1024-WF	Particle	HCHO + TVOC		
DL-1025	DL-1025-BLE	DL-1025-WF	(PM Sizes:	NH3		
DL-1026	DL-1026-BLE	DL-1026-WF	0.3µm, 0.5µm, 1µm,	H2S		
DL-1027	DL-1027-BLE	DL-1027-WF	2.5µm, 5µm, 10µm)	HCHO		
DL-1028	DL-1028-BLE	DL-1028-WF		TVOC		

Product Series

### Replaceable Filter Patch (FLT-C001)

Generally, the PM2.5 measuring sensor on the market is usually installed in outdoor applications. Because the outdoor air is quite dusty, the measuring channel of PM2.5 sensor is easily clogged by aerosol, resulting in continued alarms for the heavy concentration. Due to the error data from the clogged sensor, this module is returned to the factory for repair. Downtime during the repair period often causes significant cost and losses. In order to solve this problem, ICP DAS design the CL-200 series and DL-1000 series with replaceable patch, FLT-C001, which makes it easy for users to replace them without uninstal the devices. Cost of repair and time can be reduced by this innovated mechanical design.



### Intelligent Street Lighting in Smart City

In smart city applications, smart street lights integrate various communication technologies and are no longer illumination only. The high-density construction of streetlights have become one of the most important sources of government collecting road information in recent years. DL-1000 series products, with standard industrial communication protocol Modbus RTU/TCP, can integrate with smart streetlights to achieve outdoor air quality monitoring such as: O3, CO, CO2, SO2, NO2, TVOC, HCHO, and Particle Matter 1/2.5/10. Due to these aerosol could accumulate around the sensor and would cause error record after using for a period, DL-1000 support replaceable dust filter patch to easily change the patches inside the filter hood rather than uninstal the device.



Product Series

### Outdoor Mobile Air Quality Detection Application

In developed countries, the Air Quality detection, statistics and evaluation is the most for improvement. In a vast area, it can only rely on the vehicle moving to record status of air quality, and to offline extract these and send back sorting out.

ICP DAS DL-1000 series can integrate with our 3G/ 4G controllers to transmit data back to control center wirelessly.



### Factory Gas Detection Application

In some factories, H<sub>2</sub>S is one of the harmful gases. Due to the colorless and odorless are two characteristics quite hard to find or feel it, sometimes the workers inside the factory get injured inevitably. Joint liability from the injury brings the company a massive fines.

DL-1026 H<sub>2</sub>S detector module can put in the spot. It equip with standard industrial protocols and with high flexible to integrate information from devices and transmit back to control center. When the concentration of gas is too high, DL-1026 can also send alarm signals to inform relative person to evacuate people there.





## 3-7 iSN Series: Industrial Sensor Network Detection

**iSN Series** is a series products of Industrial Sensor Network Detection includes Leakage Detection, Indoor Illumination and humiture detection.

### Leakage Detection



**iSN-101**

### Illumination/ Humiture Detection



**iSN-201**

Module	Relay Output			Sensor			
	Ch.	Type	Max. Current Load	Ch.	Type	Range	Function
<b>iSN-101</b>	1	Signal Relay, Form C	2 A	1	Liquid	Liquid Length: 500 M	1 alarm indicator/ Adjustable detection sensitivity
<b>iSN-201</b>	1	Power Relay, Form C	NO: 10 A NC: 6 A	1	Indoor illumination	Range: 0 ~ 20,000 Lux	Temperature: -40 ~ +120°C Humidity: 0 ~ 100% RH

### Selection Guide

Industrial Sensor Network Detection	Sensor Type	Channel	Interface
iSN-101	Liquid Leakage Detection	1	RS-485
iSN-201-E	Indoor Illuminance, Temperature and Humidity		Ethernet, PoE, RS-485
iSN-201-BLE			Ethernet, PoE, RS-485, Bluetooth
iSN-201-WF			Ethernet, PoE, RS-485, Wi-Fi

**iSN-101** is a liquid leak detection module used in water pipe leak monitoring in buildings with two working modes. 1. Work with the water sense cable that installed near the possible leaking pipe or area to detect leakage with alarm. 2. Work with the water leakage probe that installed in fixed possible leak locations to detect.

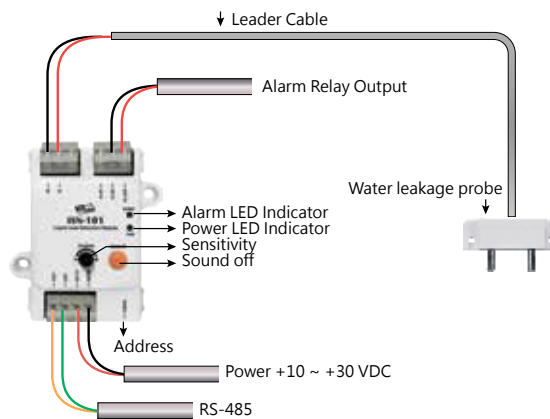
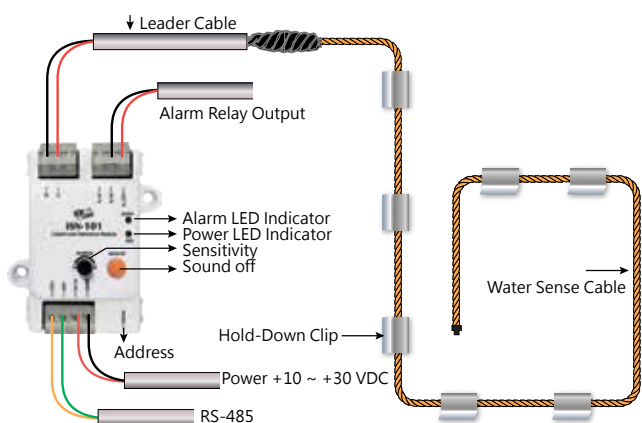

### Leakage Monitoring Application

The iSN-101 is a leakage detection module used in water pipe leak monitoring in buildings with two working modes.

1. Work with the water sense cable that installed near the possible leaking pipe or area to detect leakage with alarm.
2. Work with the water leakage probe that installed in fixed possible leak locations to detect.

The leakage monitoring is applied to the water pipes, fire pipes and sewage pipes of buildings, as well as the detecting of domestic water, drainage and electric equipment, which can effectively achieve water saving and ensure the safety of living. The iSN-101 can detect leakages, send out signal and alarms, combine with the WISE IoT Edge Controller or TPD/VPD Touch HMI, and to further integrate with the mobile APP or community system.

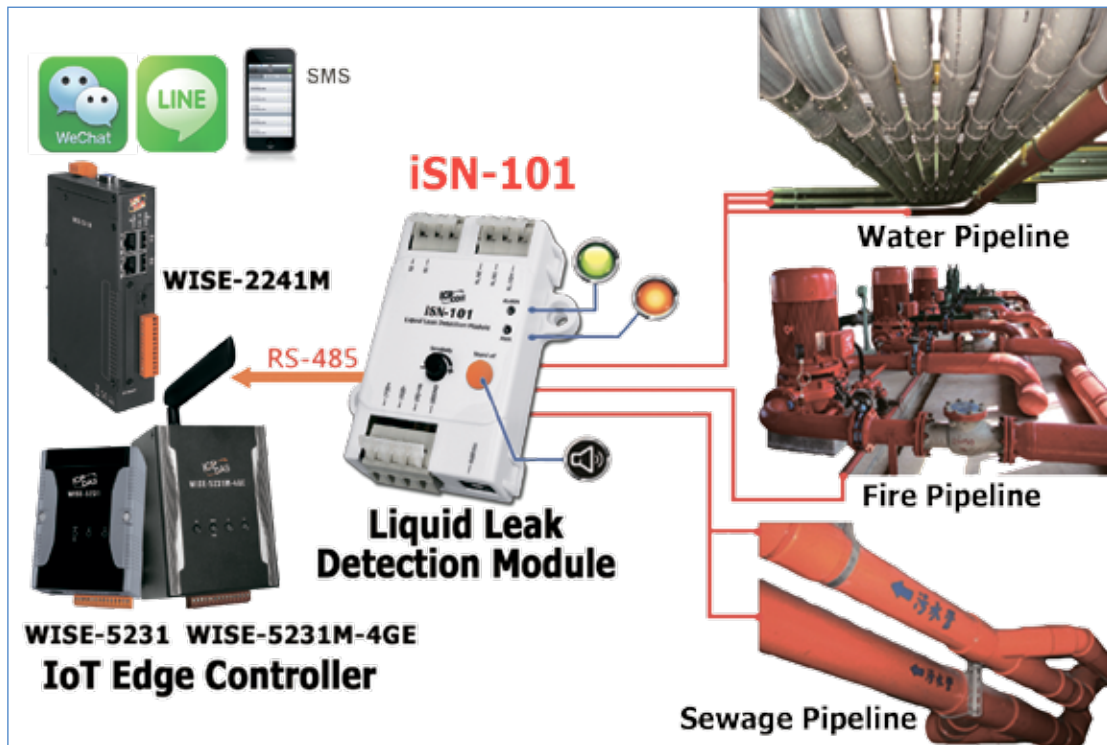

Product Series

# 3-8 PIR Series: Motion Detector

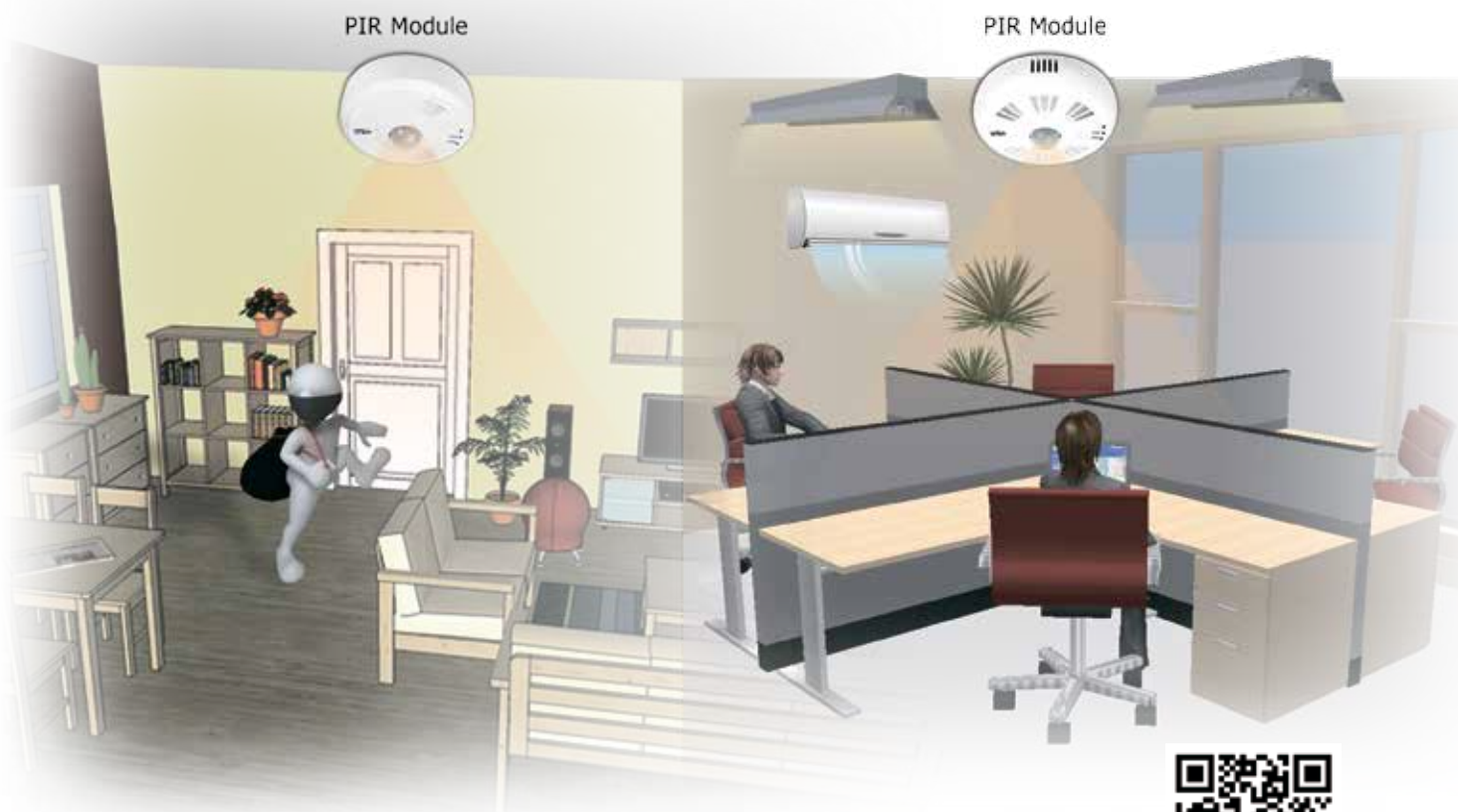

**PIR-130 series**, the Passive Infrared series, provides human motion detection and temperature measurement; and **PIR-230/231 series** provides motion detection, temperature and humidity and other environmental measurements. These series are very helpful for the indoor body sensing, anti-theft security, green energy and environmental protection and energy efficiency enhancement. A free Utility is included in the package to configurate and display of data in a powerful chart that can be exported to Excel format. The screw-free quick-connect connector, DIP switch and rotary switch, makes it easy to install, repair and maintain the product. The white color and mini-sized exterior design is quite suitable to match with interior decoration.

## Selection Guide

Model	Motion Sensor	T&R Sensor	Protocol	Interface	Detection Height		
<b>PIR-130-AC</b>	PIR	Temperature	DCON/Modbus RTU	RS-485	4m (Max.)		
<b>PIR-130-DC</b>				ZigBee			
<b>PIR-130-ZT</b>				Ethernet, PoE			
<b>PIR-230-E</b>		Temperature + Humidity	Modbus TCP, MQTT	Modbus RTU		Bluetooth	
<b>PIR-230-BLE</b>				Modbus TCP		Wi-Fi	
<b>PIR-230-WF</b>				Modbus TCP, MQTT		Ethernet, PoE	
<b>PIR-231-E</b>				Modbus RTU		Bluetooth	10m (Max.)
<b>PIR-231-BLE</b>				Modbus TCP		Wi-Fi	
<b>PIR-231-WF</b>							



# PIR-230 Series

## PIR Motion Sensor Temperature/Humidity Sensor

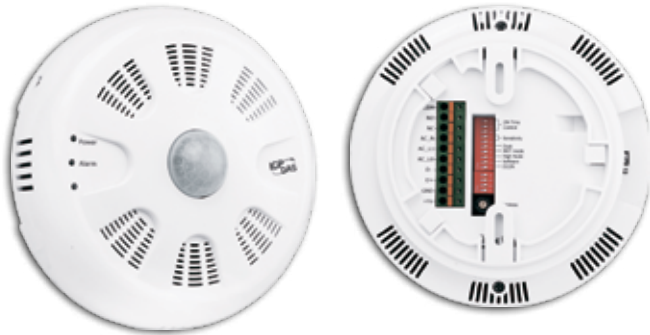

The **PIR series** can detect infrared waves generated by human within a range of approximately 8 meters in diameter with a 360° coverage area for indoor motion detection, and can be configured to auto-switch on a light if the motion is detected. It also has a temperature sensor for measuring room temperature or can be set up to activate a fire alarm. The **PIR series** especially is suitable for BA applications. There are RS-485/ZigBee/Ethernet/Bluetooth/Wi-Fi models can be selected. Different models support DCON, Modbus RTU/TCP or MQTT protocol, and can integrate HMI/SCADA/central control system.

### Features



- Adjustable Time-Delay / Lux / Sensitivity
- Internal Photosensor for Smart Switch Control
- LED Indicator for PIR/Temperature Sensor
- Temperature Sensor for Measuring Room Temperature or Fire Alarm
- Relay Output Can be Used to Control the Light Via the PIR/Temperature Sensor
- Suitable for loads up to 1500 W (Incandescent) and 300 W (Fluorescent)
- Fluorescent (T8) Loading Capability
- Multiple Communication Interfaces and Protocols
- Ceiling Surface Mount Design

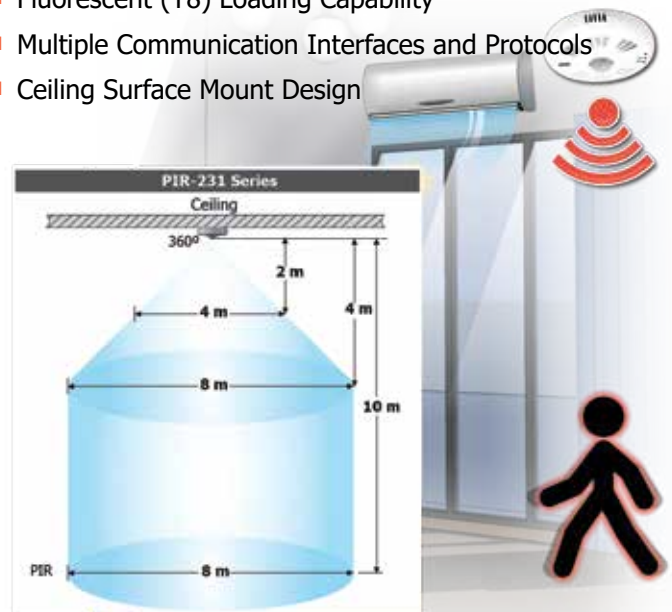

Models	PIR-130-AC	PIR-130-DC	PIR-130-ZT	PIR-230-E	PIR-230-BLE	PIR-230-WF	PIR-231-E	PIR-231-BLE	PIR-231-WF	
<b>Sensor Type</b>	<b>PIR Motion Sensor Temperature</b>			<b>PIR Motion Sensor Temperature / Humidity</b>						
<b>Passive Infrared (PIR) Motion Sensor</b>										
Time-delay	Hardware: 8-step Switch-selectable (sec) Software: 16-step (sec)									
LUX Control	Hardware: 2 mode (Dawn and dusk) / Software: 5-step									
Detection Range	4 meters max.					10 meters max.				
Detection Field of View	PIR: 360°; Diameter 8 meters Max.									
<b>Temperature Sensor</b>										
Range	-25°C ~ +100°C			-40°C ~ +125°C						
Fire Alarm	65°C (Programmable)									
Measurement	Resolution: 0.0625°C / Accuracy: ±2°C			Resolution: 0.1°C / Accuracy: ±0.6°C						
<b>Relative Humidity Measurement</b>										
Range	—			0 ~ 100 % RH						
Measurement	—			Resolution: 0.1% RH / Accuracy: ±5% RH						
<b>I/O Channel</b>										
AC Digital Input	—			—			—			
Relay Output	1			1			1			
<b>Communication</b>										
Protocol	DCON, Modbus RTU			DCON, Modbus RTU, Modbus TCP, MQTT						
Wired Interface	Yes, RS-485 x 1			Yes, RS-485 x 1 and Ethernet/PoE x 1						
Wireless Interface	—	—	ZigBee	—	Bluetooth	Wi-Fi	—	Bluetooth	Wi-Fi	

# 3-9 WF Series: Wi-Fi Modules

Nowadays, Wireless LAN applications are very popular. They're not only faster than traditional industrial transmissions, i.e. RS-232, RS-485, RS-422 etc, but are also able to minimize the need for troublesome wiring tasks and have a higher mobility than an Ethernet network.



Classified Index		Model Name
WLAN Remote Maintenance Device		M2M-711D
CAN to Wi-Fi Converter		I-7540D-WF
Ethernet to Wi-Fi Bridge		WF-2572, WF-2572M
WLAN Gateway		RMV-760D-MTCP
Wi-Fi Access Point		APW77BAM
Ethernet/UART to Wi-Fi Converter		IOP760AM
WiFi Modbus Data Concentrator		MDC-211-WF
Wi-Fi I/O Modules	Thermocouple, Voltage & Current Input Module	WF-2017, WF-2019
	RTD Input Module	WF-2015
	Digital I/O Module	WF-2042, WF-2051, WF-2055
	Relay Output & Digital Input Module	WF-2060, WFM-R14
	Multifunction I/O Module	WF-2026

## ▼ WLAN Remote Maintenance Device

### Pair Connection Architecture (one-to-one)

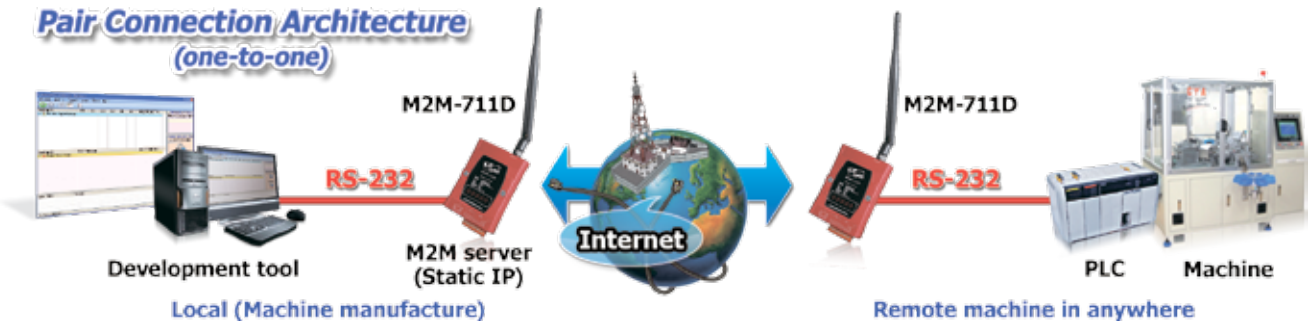

## ▼ CAN to Wi-Fi Converter



## ▼ Ethernet to Wi-Fi Bridge

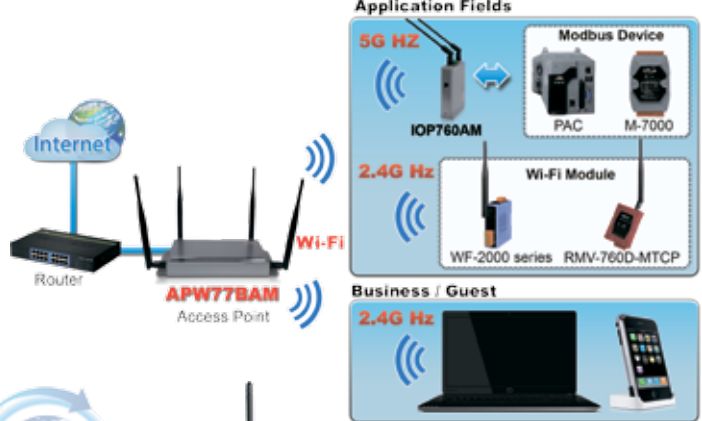

## ▼ WLAN Gateway

### Pair-Connection

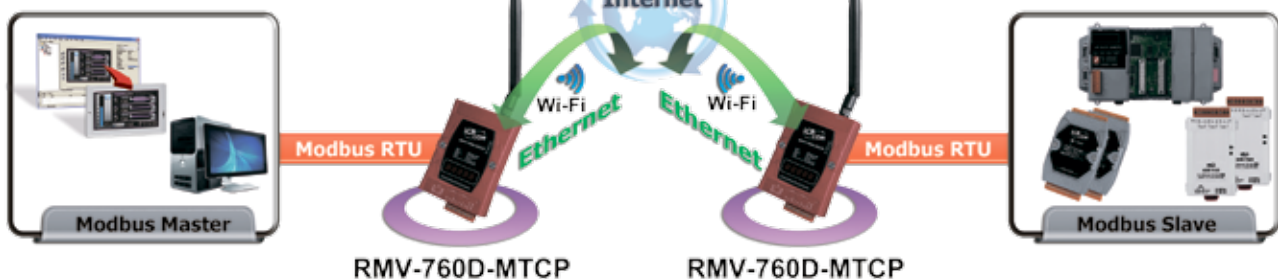

Product Series

# WF-2000 / tWF Series Wi-Fi I/O Modules

**WF-2000 & tWF Series** are the series of Wi-Fi wireless remote I/O modules. With the popularity of 802.11 network infrastructure, the WF-2000 makes an easy way to incorporate wireless connectivity into monitoring and control systems.

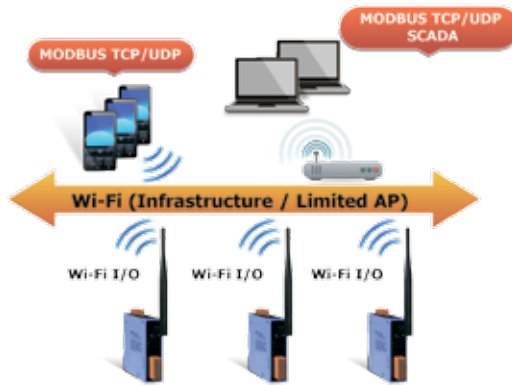

## Features

- Compatible with IEEE 802.11 b/g/n standards
- Support infrastructure and Limited AP modes
- Support WEP/WPA/WPA2 wireless encryption
- Support Modbus TCP/UDP protocols
- Support DHCP network configuration

### ✓ RTD, Thermocouple, Voltage & Current Input Module

Model Name	AI		
	Channel	Voltage and Current Input	Sensor Input
<b>WF-2015</b>	6	—	RTD: Pt100, Pt1000, Ni120, Cu100, Cu1000
<b>WF-2017</b>	8/16 (DIFF/SE)	±150 mV, ±500 mV, ±1 V, ±5 V, ±10 V, 0 ~ +20 mA, +4 ~ +20 mA, ±20 mA	—
<b>WF-2019</b>	10	±15 mV, ±50 mV, ±100 mV, ±500 mV, ±1 V, ±2.5 V, ±5 V, ±10 V, ±20 mA	Thermocouple: J, K, T, E, R, S, B, N, C

### ✓ Digital I/O Module

Model Name	DI/Counter			DO			
	Ch.	Contact	Sink/Source	Channel	Type	Sink/Source	Max. Load Current @ 25°C
<b>WF-2042</b>	—	—	—	16	Open Collector	Sink	700 mA/channel
<b>WF-2051</b>	16	Dry, Wet	Dry: Source; Wet: Sink/Source	—	—	—	—
<b>WF-2055</b>	8	Dry, Wet	Dry: Source; Wet: Sink/Source	8	Open Collector	Sink	700 mA/channel

### ✓ Relay Output & Digital Input Module

Model Name	DI/Counter			Relay Output		
	Channel	Contact	Sink/Source	Channel	Relay (Type)	Max. Load Current @ 25°C
<b>WF-2060</b>	6	Dry, Wet	Dry: Source; Wet: Sink/Source	6	Power Relay (Form A)	5.0 A/channel
<b>WFM-R14</b>	—	—	—	14	2 Power Relays (Form A) 12 Power Relays (Form C)	5.0 A/channel (Form A) 6.0 A/channel (Form C)

### ✓ Multifunction Module

Model Name	AI		AO		DI/Counter		DO	
	Channel	Voltage and Current Input	Channel	Voltage and Current Output	Channel	Contact	Channel	Type
<b>WF-2026</b>	5	±150 mV, ±500 mV, ±1 V, ±5 V, ±10 V, 0 ~ 20 mA, 4 ~ 20 mA, ±20 mA	2	0 ~ 5 V, 0 ~ 10 V, ±5 V, ±10 V, 0 ~ 20 mA, 4 ~ 20 mA	2	Dry (Source)	3	Open Collector (Sink)

### ✓ Tiny Wi-Fi Digital I/O Module

Model Name	DI		DO	
	Model Name	Contact	Model Name	Type
<b>tWF-PD4R3</b>	4	Dry: Sink	3	Relay (Form A) DC30V/5A, AC250V/5A
<b>tWF-PD4SR2A</b>	4	Dry: Sink	2	AC SSR, AC240V/1.5A
<b>tWF-PD4SR2D</b>	4	Dry: Sink	2	DC SSR, DC3~30V/1A
<b>tWF-PD8</b>	8	Dry: Sink	—	—
<b>tWF-R6</b>	—	—	6	Relay (Form A) DC30V/5A, AC250V/5A

Product Series



# 3-10 Voice Alert Module: ALM-06-WF



**ALM-06-WF**

## Features

- Compatible with IEEE 802.11 b/g/n, 2.4GHz
- Support WEP/WPA/WPA2 wireless encryption
- Support Wi-Fi AP and Station modes
- Support Modbus TCP slave protocol
- 3W speaker, external Line out
- 99 dB/1kHz at 1m
- microSD card to store max. 64 MP3 voice files
- 6x DI, 1x Relay
- Voice Alert triggered by DI or Modbus TCP command

## Introduction

**ALM-06-WF** is equipped with a 4 GB microSD card to store MP3 files. The ALM-06-WF can play the MP3 files when the DI status matches the pre-defined conditions or gets Modbus TCP commands via the Wi-Fi. The built-in speaker power is only 3W. It is about 99 dB, 1 meter away the module. When requires for louder sound, the module also features audio line out to external speaker.

The ALM-06-WF provides 8 modes to define the DI conditions to play MP3 files. The conditions can be simply mapped to each DI channel to have 6 conditions or mapped to 5 DI channels combination status to have 32 conditions. And every condition not only plays the MP3 files but also can be configured to turn on the built-in relay to trigger a warning lamp. That means with WLM-06-WF can have both voice and light warning.



## Applications



Model	Interface		Channel		Audio Format	Sound Pressure Level	Audio Output
	RS-485	Wi-Fi (2.4GHz)	DI (Dry)	Relay			
<b>ALM-06-WF</b>	—	Yes	6	1	MP3, 64x Files	99 dB @ 1 meter	3W
<b>ALM-04-RTU</b>	Yes	—	4	(500mA@50VDC)			

Application Field

System Solutions

Product Series

# 3-11 ZT Series: ZigBee Wireless Modules



## Features



- ISM 2.4 GHz Operating Frequency and Fully Compliant with 2.4G IEEE 802.15.4 / ZigBee PRO (2007)
- Support 3 topologies defined in the ZigBee standard: Mesh, Star and Cluster Tree
- Support the 128-bit AES (Advanced Encryption Standard) encryption
- GUI Configuration Software (Windows Version)
- ZigBee Node Supports Active Routing
- Supports Topology Utility for Network Monitoring and Improvement
- Wireless Transmission Range up to 700 m (Default)
- Provide Signal Strength LED Indicator
- Wide Operating Temperature (-25 ~ 75 °C)

ZigBee is a specification based on the IEEE 802.15.4 standard for wireless personal area networks (WPANs). ZigBee operates in the ISM radio bands, and it defines a general-purpose, inexpensive, self-organizing, mesh network for industrial control, medical data collection, smoke and intruder warning, building automation and home automation, etc.



## ZigBee Converter

Every network must have one host (coordinator) device for initializing, maintaining, and controlling the network; one or more slave devices (full function devices) are responsible for routing messages.

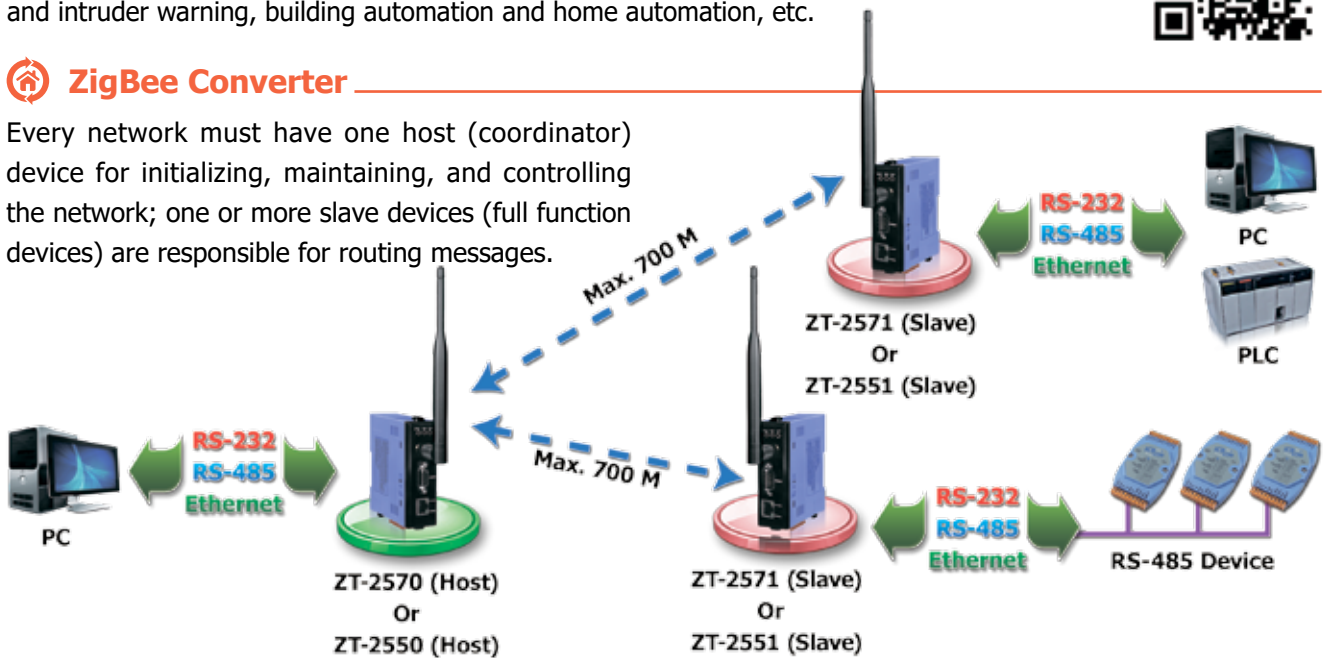

Product Series

Model	Interface	Module Type	Transmit Power	Antenna	Distance (LOS)
ZT-2550	1 × RS-232、1 × RS-485	Host (Coordinator)	11 dBm	2.4 GHz, 5 dBi Omni-Directional antenna	700 m
ZT-2551	1 × RS-232、1 × RS-485	Slave (Router)	11 dBm	2.4 GHz, 5 dBi Omni-Directional antenna	700 m
ZT-2570	1 × RS-232、1 × RS-485 1 × Ethernet	Host (Coordinator)	11 dBm	2.4 GHz, 5 dBi Omni-Directional antenna	700 m
ZT-2571	1 × RS-232、1 × RS-485 1 × Ethernet	Slave (Router)	11 dBm	2.4 GHz, 5 dBi Omni-Directional antenna	700 m
ZT-USBC	1 × USB	Full Function (Coordinator/Router)	3 dBm	2.4 GHz, PCBantenna	60 m

### ZigBee Repeater

The ZT-2510 is a ZigBee repeater to extend the distance of ZigBee network or avoid an obstacle that may be located between two wireless devices.

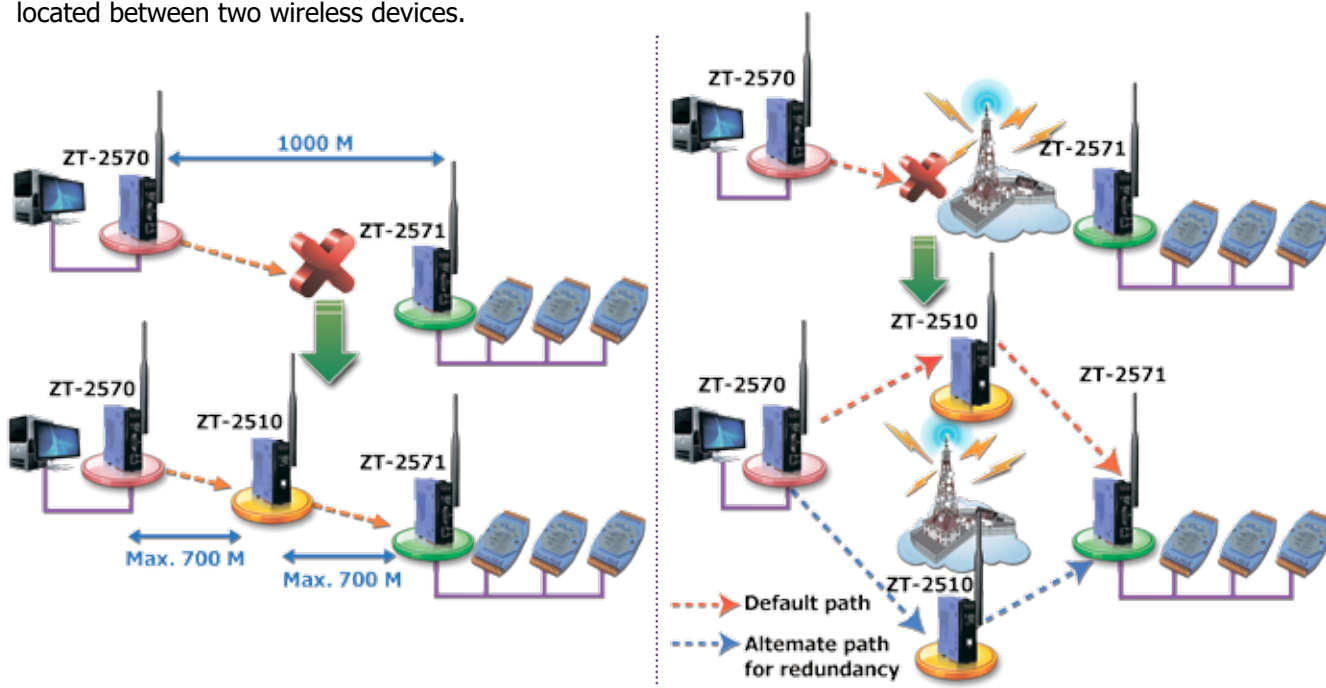

Model	Interface	Module Type	Transmit Power	Antenna	Distance (LOS)
ZT-2510	ZigBee	Slave (Router)	11 dBm	2.4 GHz, 5 dBi Omni-Directional antenna	700 m

### ZigBee Bridge

The ZT-2530M is a ZigBee bridge operating as a bridge between two ZigBee networks. It is full hardware configuration, used to communicate indoor and outdoor units or divide complex network to enhance efficiency.

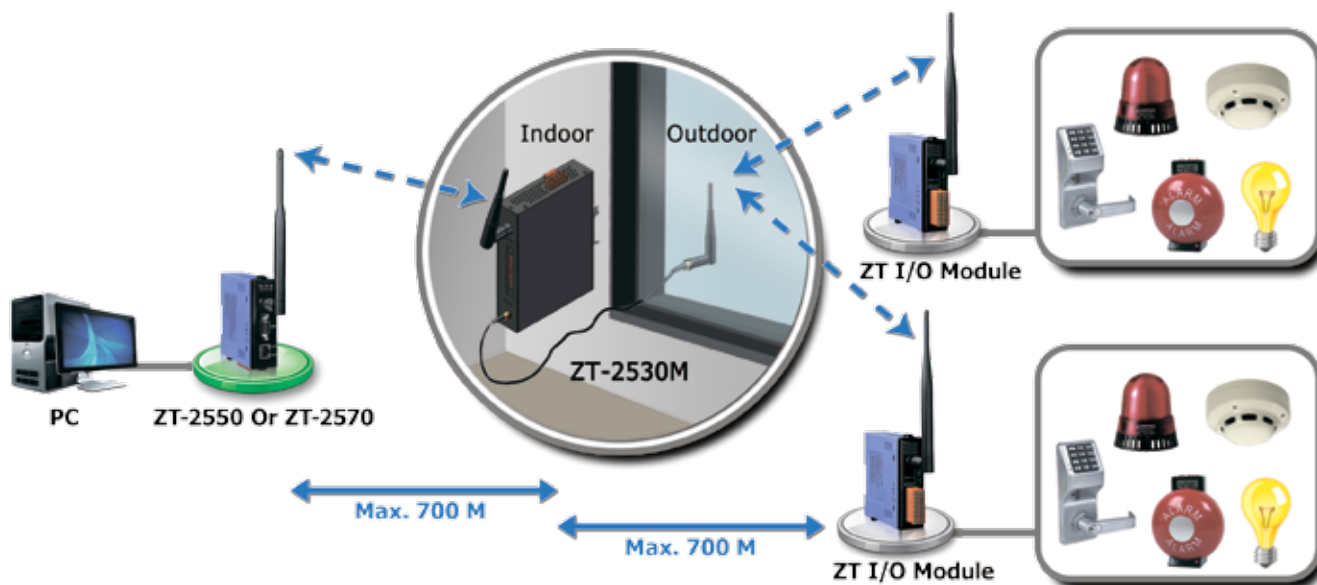

Model	Interface	Module Type	Transmit Power	Antenna	Distance (LOS)
ZT-2530M	ZigBee	Slave (Router) + Host (Coordinator)	11 dBm	2.4 GHz, 5 dBi Omni-Directional antenna	700 m



## ZigBee I/O Group Module (Full Function)



The ZT-20xx-IOG module is a series of wireless ZigBee I/O module built-in the IOG (I/O Pair-connection Group) function. With ZigBee wireless communication and remote active I/O features, the ZT-IOG module can manage devices' DIO states in the buildings to exchange and update the I/O channels actively.

The ZT-20xx-IOG provides Ethernet, RS-232 or RS-485 communication interface. It is a data concentrator that no programming and no dealing with the wireless communication interference needs, but can quickly establish, monitor and manage the I/O pair-connection with the decentralized DIO channels. It suits the multi-host monitoring and I/O Pair-connection wireless applications for the environment of needing many I/O points, large communication range and not easy wiring.

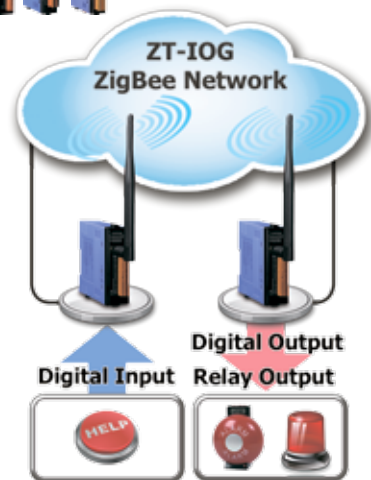

Model	Channel	Type	Channel	Type
<b>ZT-2043-IOG</b>	DO: 14	Open Collector (700mA, Sink)		
<b>ZT-2053-IOG</b>	DI: 14	Dry/Wet (Sink/Source)		
<b>ZT-2055-IOG</b>	DI: 8	Dry/Wet (Sink/Source)	DO: 8	Open Collector(650 mA, Sink)
<b>ZT-2060-IOG</b>	DI: 6	Wet (Sink/Source)	DO: 4	Power Relay (5 A @ 250 VAC/30 VDC)

## ZigBee I/O Module (Router)



Model	Channel	Type	Channel	Type
<b>ZT-2005-C8</b>	AI: 8	10 K Thermistor (Measuring Temperature Range: -40°C ~ 105°C )		
<b>ZT-2015</b>	AI: 6	Pt100, Pt1000, Ni120, Cu100, Cu1000		
<b>ZT-2017</b>	AI: 8	±10 V, ±5 V, ±1V, ±500 mV, ±150 mV or -20 mA ~ +20 mA (Requires External 125 Ω Resistor)		
<b>ZT-2017C</b>	AI: 8	20 mA ~ +20 mA, 0 mA ~ +20 mA or +4 mA ~ +20 mA		
<b>ZT-2018</b>	AI: 8	±15 mV, ±50 mV, ±100 mV, ±500 mV, ±1V, ±2.5V, ±20 mA, 0 ~ 20 mA or 4 ~ 20 mA Thermocouple (J, K, T, E, R, S, B, N, C, L, M, LDIN43710)(Requires Optional External 125 Ω Resistor for current input)		
<b>ZT-2024</b>	AO: 4	0 ~ +10 VDC, -10 VDC ~ +10 VDC, 0 ~ +5 VDC, -5 VDC ~ +5 VDC, 0 ~ +20 mA, +4 mA ~ +20 mA		
<b>ZT-2026</b>	AI: 4	±10 V, ±5 V, ±1 V, ±500 mV, ±150 mV or -20 mA ~ +20 mA	AO: 2	±10 VDC, ±5 VDC, 0 ~ 10 VDC or 0 ~ 5 VDC
	DI: 2	Wet (Sink)	DO: 2	Open Collector (700 mA, Sink)
<b>ZT-2042</b>	DO: 8	4*PhotoMOS Relay (1 A, Sink/Source) / 4*Open Collector (700 mA, Sink)		
<b>ZT-2043</b>	DO: 14	Open Collector (700mA, Sink)		
<b>ZT-2052</b>	DI: 8	Wet (Sink/Source)		
<b>ZT-2053</b>	DI: 14	Dry/Wet (Sink/Source)		
<b>ZT-2055</b>	DI: 8	Dry/Wet (Sink/Source)	DO: 8	Open Collector (650 mA, Sink)
<b>ZT-2060</b>	DI: 6	Wet (Sink/Source)	DO: 4	Power Relay (5 A @ 250 VAC/30 VDC)

## ZigBee Accessories: External Antenna/Cable



Optional Accessories	Description and Website
<b>External Antenna</b>	2.4 GHz External Antenna, RP SMA Male (Plug)
External Antenna: <a href="http://www.icpdas.com/root/product/solutions/industrial_wireless_communication/wlan_products/external_antenna.html">http://www.icpdas.com/root/product/solutions/industrial_wireless_communication/wlan_products/external_antenna.html</a>	
<b>External Cable</b>	3S00x-1, RG58A/U x Meter Long RP-SMA male to RP-SMA Female
Extension Cable: <a href="http://www.icpdas.com/root/product/solutions/accessories/cable/cable_selection.html">http://www.icpdas.com/root/product/solutions/accessories/cable/cable_selection.html</a>	

Product Series

# 3-12 IR Series: Infrared Wireless Modules

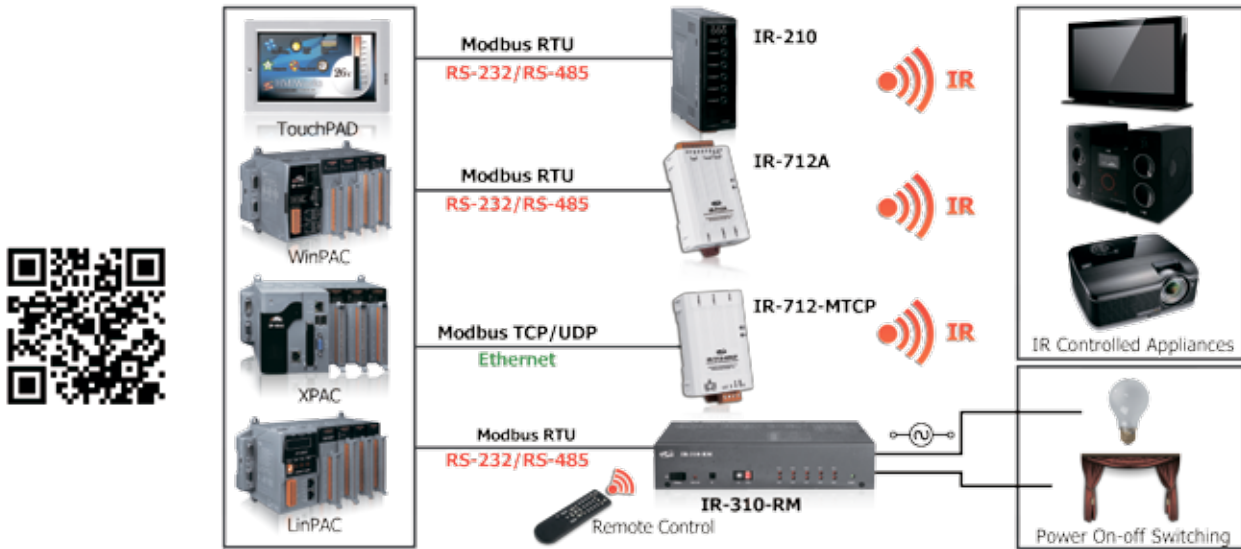

IR (infrared) technology is now used for controlling home devices including television, air conditioner, curtain, and etc. ICP DAS has developed various IR products to implement in home automation. These IR products can help users to control and integrate all IR devices into a control system. Therefore, by integrating the PAC and other series of ICP DAS devices, users can easily establish a home automation system. **IR Series** includes "IR learning remote modules" and "IR controlled power relay module". The former are used to collect and transmit a variety of devices infrared remote commands, while the latter is a strong relay module with the electric remote control function.

## IR Smart Home Application

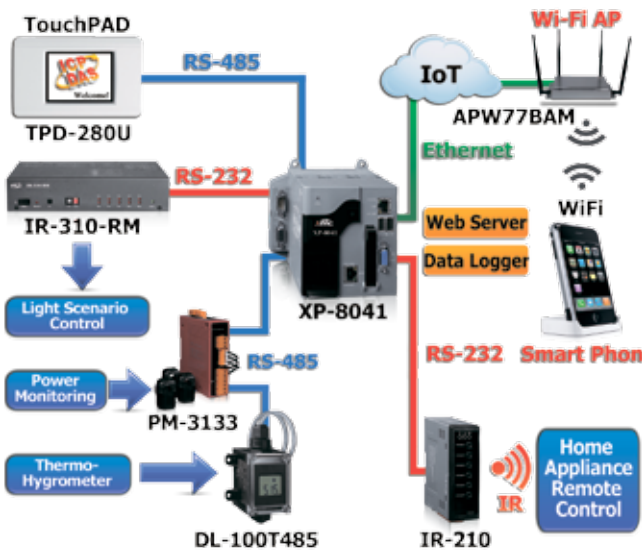

## IR + Wi-Fi Wireless Control Application

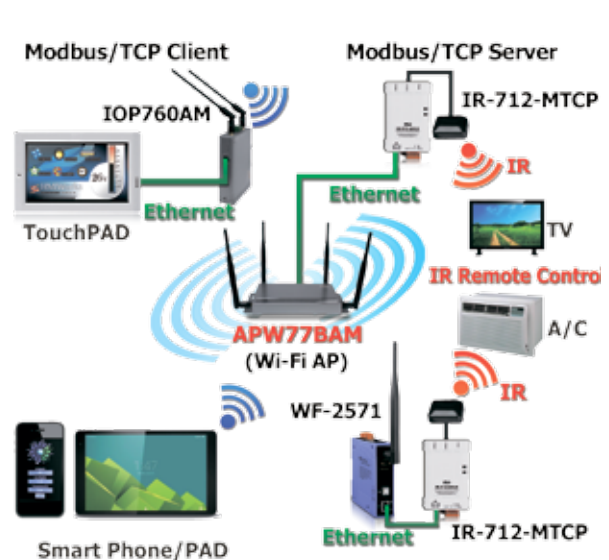

## Selection Guide

Type	IR Learning Remote Modules			IR Controlled Power Relay Module
Model	IR-210	IR-712A	IR-712-MTCP	IR-310-RM
Output	IR Output x 6	IR Output x 2	IR Output x 2 Modbus TCP	Relay Output x 10
Included Cable	Two CA-IR-SH2251 (-5 model with -5 model cable) and one CA-0910		Two CA-IR-SH2251 (-5 model with -5 model cable)	One CA-IR-SH2251-5, one CA-IR-001, one CA-0910 and one remote control L108E

# Universal IR Learning Remote Module

**IR-210    IR-712A    IR-712-MTCP**

## Features



- IR Output: channels for remote controlling multiple devices
- IR Input: can learn and store IR Commands
- Supports 6 learning IR carrier frequencies
- Built-in Watchdog
- Provide LEDs: Transmitting / Learning / Power



ICP DAS universal IR learning remote module can learn IR remote commands of diverse electronic devices, and store the commands in the module or saved to a file. The RS-232/485/Ethernet interfaces provide flexible expansion and control the module. The software utility provides users with easy configuration, learning, test and storage of IR commands. It is well-designed for smart home and building automation.

### IR Utility: configuration, IR learning and waveform display

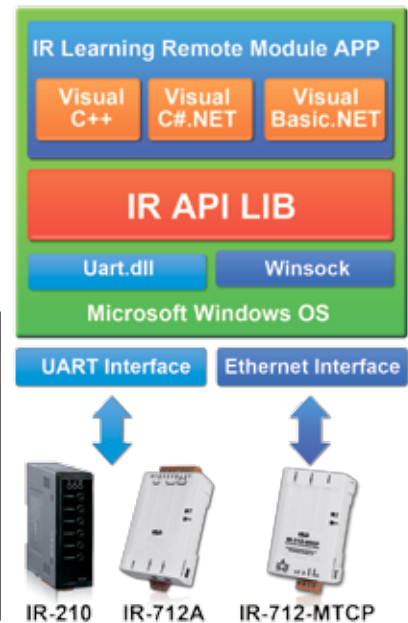
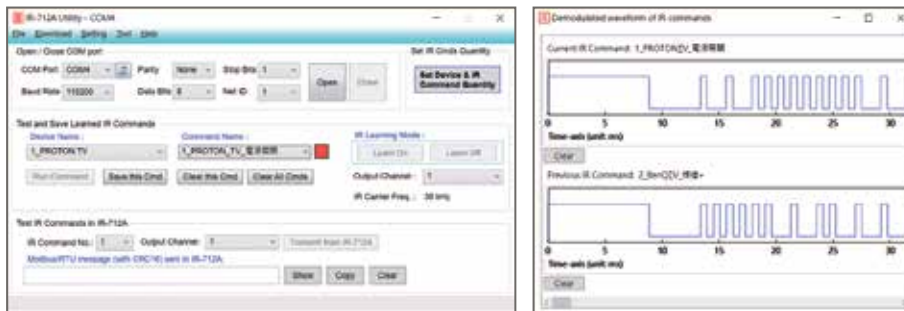

**ICP DAS PAC**

**WinCE PAC**

- XPAC
- WinPAC
- ViewPAC

**Linux PAC**

**MiniOS PAC**

- LinPAC
- µPAC
- iPAC
- ViewPAC

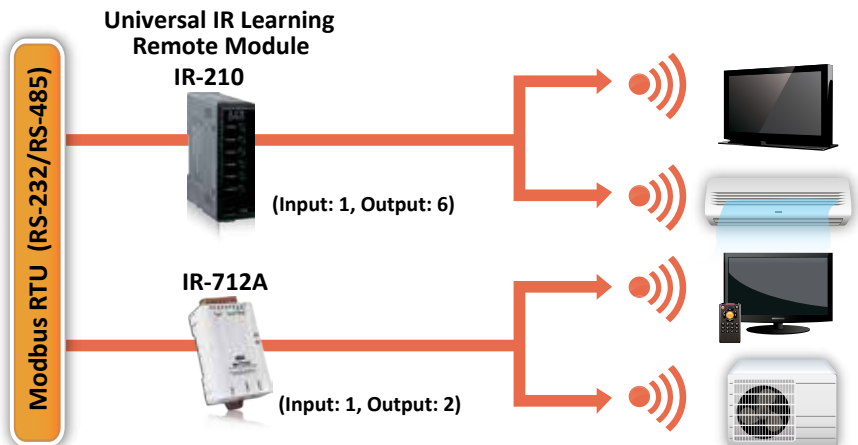

Product Series

Model	IR-210	IR-712A	IR-712-MTCP
IR Output Channels	6		2
IR Commands Storage	224	224	512
Support IR Carrier Freq.	33、36、37、38、40、56 kHz		
Serial Comm. Interface	RS-232 × 1 and RS-485 × 1		Ethernet × 1
Protocol	Modbus RTU (Slave)		Modbus TCP/UDP (Server)
Size (W x H x L) (mm)	33 × 107 × 78	52 × 93 × 27	52 × 85 × 27



# IR Controlled Power Relay Module

## IR-310-RM



IR-310-RM is a 10-channel high power relay module designed for the power control of various appliances. The application field can be manual/automatic power switch, scenario light control and energy saving.

Model	IR-310-RM
Relay Output	10 outputs (Form C)
Contact Rating	5 A @ 220 VAC × 6; 10 A @ 220 VAC × 4 (Operating temperature: 25°C )
Protocol Interface	Modbus RTU RS-232, RS-485
IR Commands	Self-defined: 64; built-in 32
IR Input	On-board IR receiver / Audio jack

### Features



- 10 channels high power relays
- Supports IR commands for relay control
- NO & NC terminals for each channel
- Protection circuit for each channel
- Sequential relay control
- Support max. 5 sets of interlocked relay pairs
- Power-on values and power failure memory

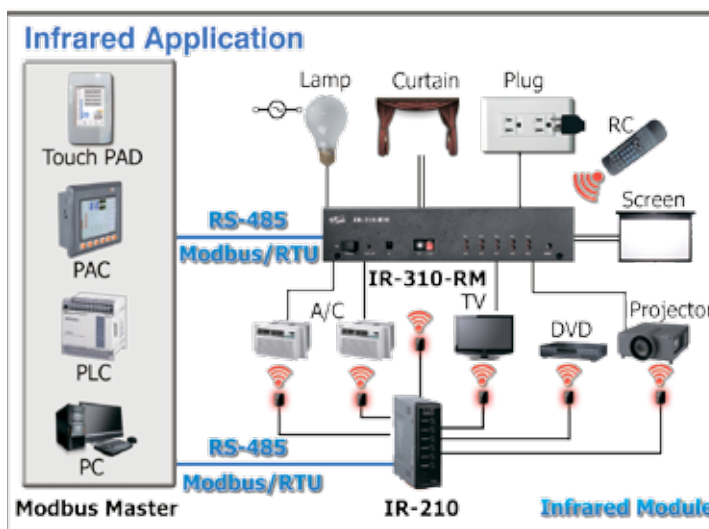

### IR Accessories & Usages

IR series modules need to equip with an IR signal cable in order to transmit or receive infrared remote control signals. ICP DAS provides single-headed, dual-headed and semi-sphere-headed first-class IR cables to meet different wiring requirements. IR cable can be extended the distance according to the actual wiring situation.

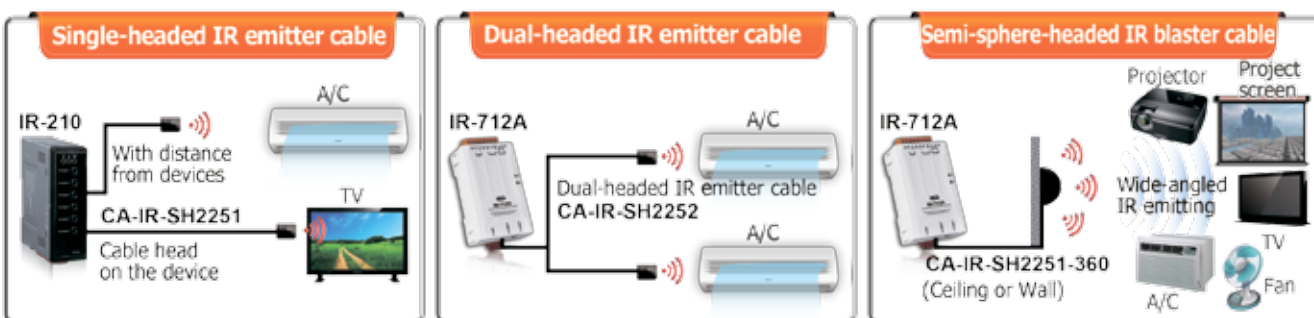

Model	Description	Model	Description
CA-IR-SH2251	Single-headed IR emitter cable (with adhesive pad, Ø 3 mm IRED, 2.5 m)	CA-IR-SH2251-360	Semi-sphere-headed IR blaster cable (with adhesive pad, 2.5 m)
CA-IR-SH2252	Dual-headed IR emitter cable (with adhesive pad, Ø 3 mm IRED, 2.5 m)	CA-IR-SH1251-360	Semi-sphere-headed IR receiver cable (with adhesive pad, 2.5 m)
CA-IR-SH2251-5	Single-headed IR emitter cable (with adhesive pad, Ø 5 mm IRED, 2.5 m)	CA-IR-001	IR receiver cable, 3 m
CA-IR-SH2252-5	Dual-headed IR emitter cable (with adhesive pad, Ø 5 mm IRED, 2.5 m)	L108E	IR learning remote control

# 3-13 IIoT Series:

## IIoT Management Software + IIoT Edge Controller + IIoT Communication Server + Data Concentrator

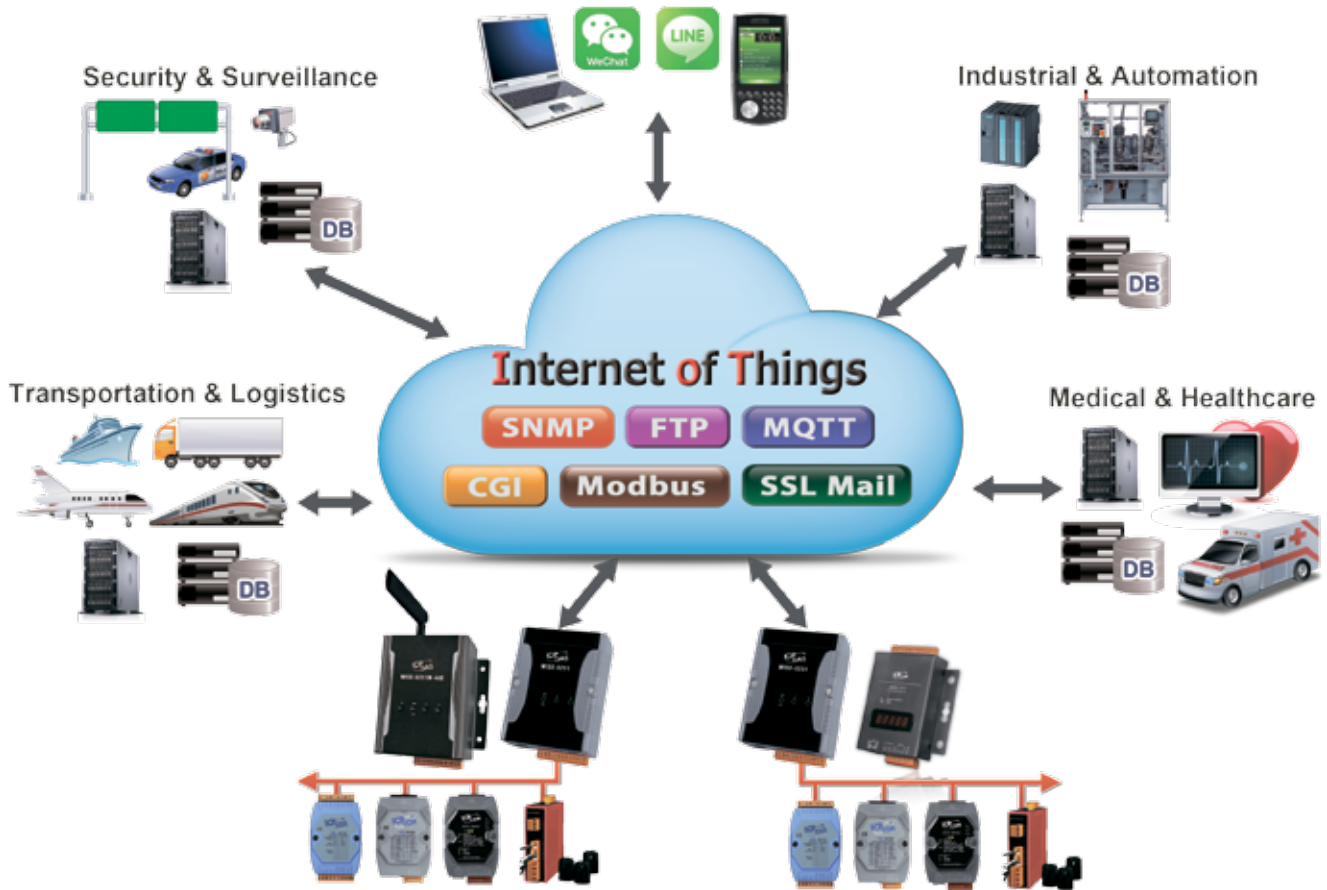

Industrial Internet of Things (IIoT) is the new cloud trend, and the IoT technology which makes all the devices communicate with each other is the first jigsaw puzzle of the entire cloud vision. To meet the demand for industry, ICP DAS offers software, controllers, I/O modules and sensors. Our goal is to take the data to the cloud and make the whole system very easy to monitor, manage and maintain.

### Selection Guide

Type	IIoT Edge Controller		IIoT Communication Server		Data Concentrator	
Series	WISE Series		UA Series		ZT Series	MDC Series
Product	3G/4G Metal	Metal	Metal	3G/4G Metal	ZigBee Wireless	Modbus Metal

Product Series

**IoTstar: IIoT Cloud Management Software**



IoTstar is a software developed by ICP DAS for use in remote management of the IIoT Edge Controller (WISE/PMC/PMD) on a private or public cloud platform such as: Microsoft Azure, IBM Bluemix or Amazon AWS, etc. With the help of the IoTstar and the IIoT Edge Controller, data of sensors or power meters can be quickly and easily collected and imported to the database on the cloud platform; and users can analyze and generate report by using the tools of the cloud platforms.

**Features:**

- 1. Public Cloud: Microsoft Azure, IBM Bluemix, Amazon AWS
- 2. Private Cloud: Microsoft Windows 7/8/10
- 3. Remote Management and Maintenance
- 4. Remote Monitoring and Control
- 5. Cloud Big Data
- 6. Data Analysis and Report by Public Tools

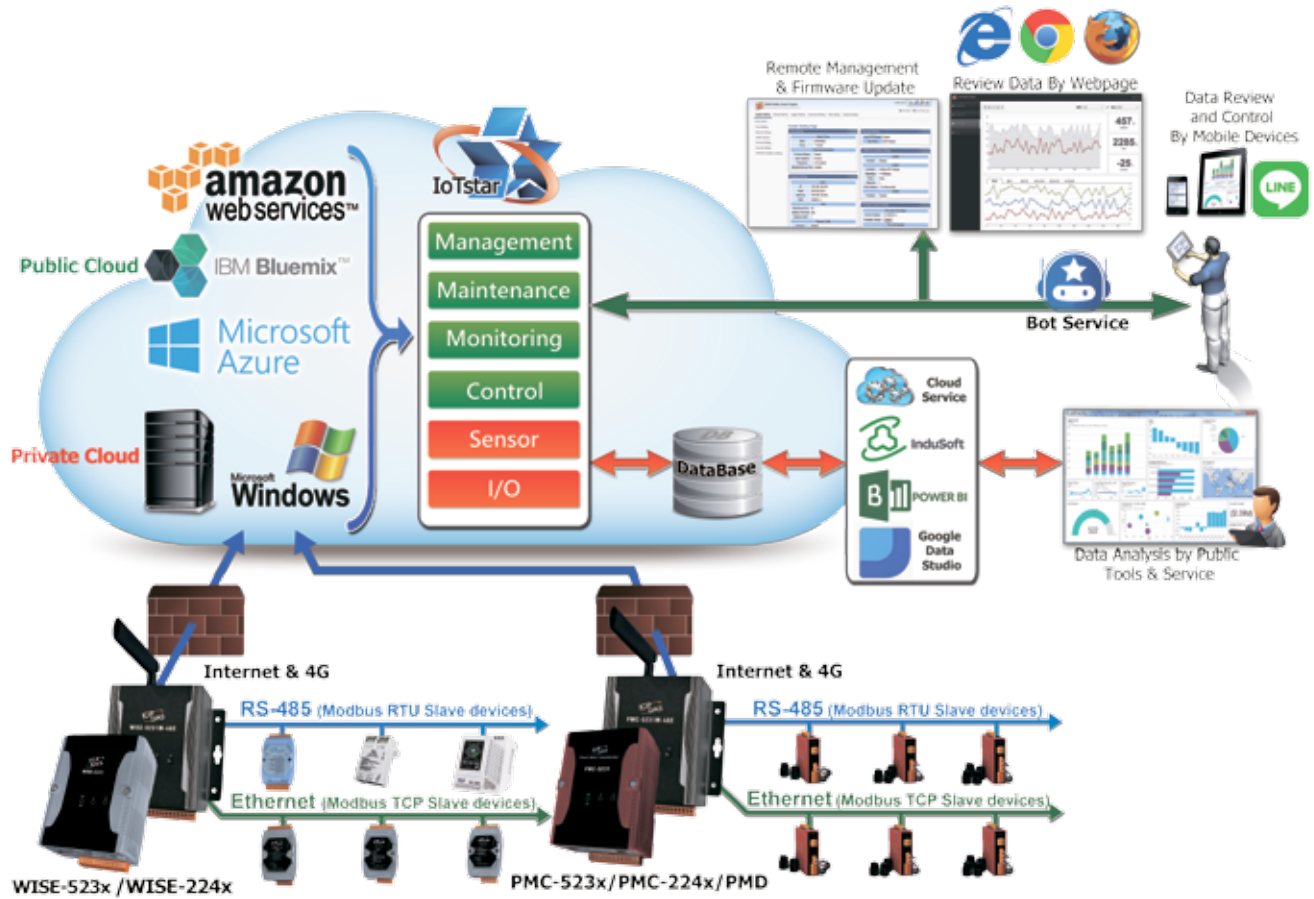

Product Series



### Based on Public Cloud

Can be installed on Microsoft Azure, IBM Bluemix or Amazon AWS to implement the public IoT cloud solution.



### Based on Private Cloud

Support Windows system (Windows 7/8/10, Windows Server) to implement the private IoT cloud solution.



### Remote Management and Maintenance

Enables the remote management and firmware update on the WISE/PMC/PMD controllers via user-friendly and intuitive Web page interface.



### Remote Monitoring and Control

User can retrieve and review the data of the sensors directly by the built-in Web page interface.

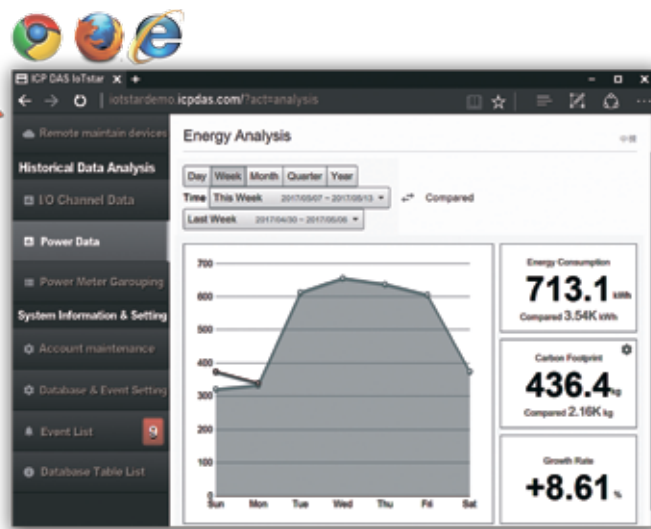

Product Series

### Cloud Big Data

Receive the data log file of the sensors from the remote WISE/PMC/PMD Controllers and import the content of the data log file into the Database.

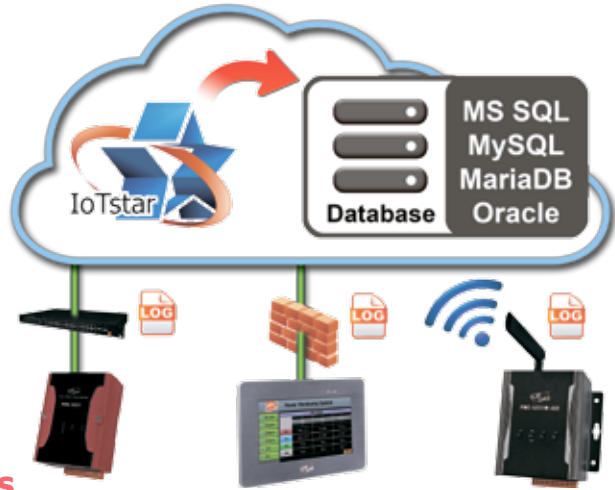

### Analysis and Report by Public Tools

By Database interface, it is easy to integrate with SCADA, Microsoft Power BI, Google Data Studio or Cloud Service to retrieve the data of the Sensors directly from the Database for future data analysis.



▲ Analysis and Report by Microsoft Power BI



▲ Analysis and Report by Google Data Studio

### Products support IoTstar:



**WISE-523x series:**

IIoT Edge Controller



**WISE-523xM-3GWA**  
**WISE-523xM-4GE**

3G/4G IIoT Edge Controller



**WISE-2241M**

IIoT Edge Controller



**PMC-523x series:**

IIoT Concentrator for power meters



**PMD series:**  
IIoT Concentrator with touch panel display for power meters

## IoTstar Bot Service (Supported LINE App)

**IoTstar Bot Service** is an optional software package for IoTstar that provides users two-way message interactions between the WISE/PMC/PMD controller managed by IoTstar and LINE chat rooms. IoTstar Bot Service provides an easier and more convenient mechanism for user to manage his/her remote controllers with LINE App. It does not like the traditional Chatbot which get the information or service by entering the text message; it provides a friendly user interface that includes buttons and dialogue menu to perform the monitoring of remote controllers in an easy way.

With IoTstar Bot Service, users can query the real-time I/O Channel data (or power data) of the on-site I/O modules or power meters and be able to change the value of DO/AO output channels anytime and anywhere. IoTstar Bot Service also provides functions to receive, store, and query the event messages. The controllers can be triggered to send event messages to IoTstar Bot Service by IF-THEN-ELSE rules. After IoTstar Bot Service receive these event messages, it would process and send them to relative LINE users for real-time alarm notification. In addition, IoTstar Bot Service also provides the function to store and query the historical received event messages for system operation analysis.



### Features

- Monitor WISE/PMC/PMD controllers anytime and anywhere by LINE App.
- Query real-time I/O channel (power meter) data and change the value of DO/AO channels..
- Quickly browse the real-time I/O channel data efficiently by Grouping data.
- Receive real-time event messages with text, pictures or videos (WISE can work with the iCAM IP camera to send the picture or video files).
- Review and query the historical event messages.
- Secure and reliable communication mechanism between LINE and controllers.
- Easy to Maintain; only need the upgrade of LINE App.

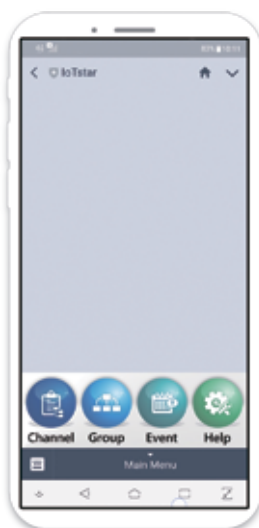

Operation User Interface



Query I/O channel (or power) data



DO/AO channel setting



Event notification and query



### WISE-5231 : IIoT Edge Controller



WISE-5231 is an IIoT edge controller (**Web Inside, Smart Engine**) that functions as control units for use in remote logic control and monitoring in various industrial applications. WISE-5231 supports SNMP, SNMP Trap, MQTT and DDNS protocols and services. The flexible integration ability with the SCADA/IT/IoT systems makes WISE-5231 a perfect concentrator of sensor and I/O modules in the IIoT age.

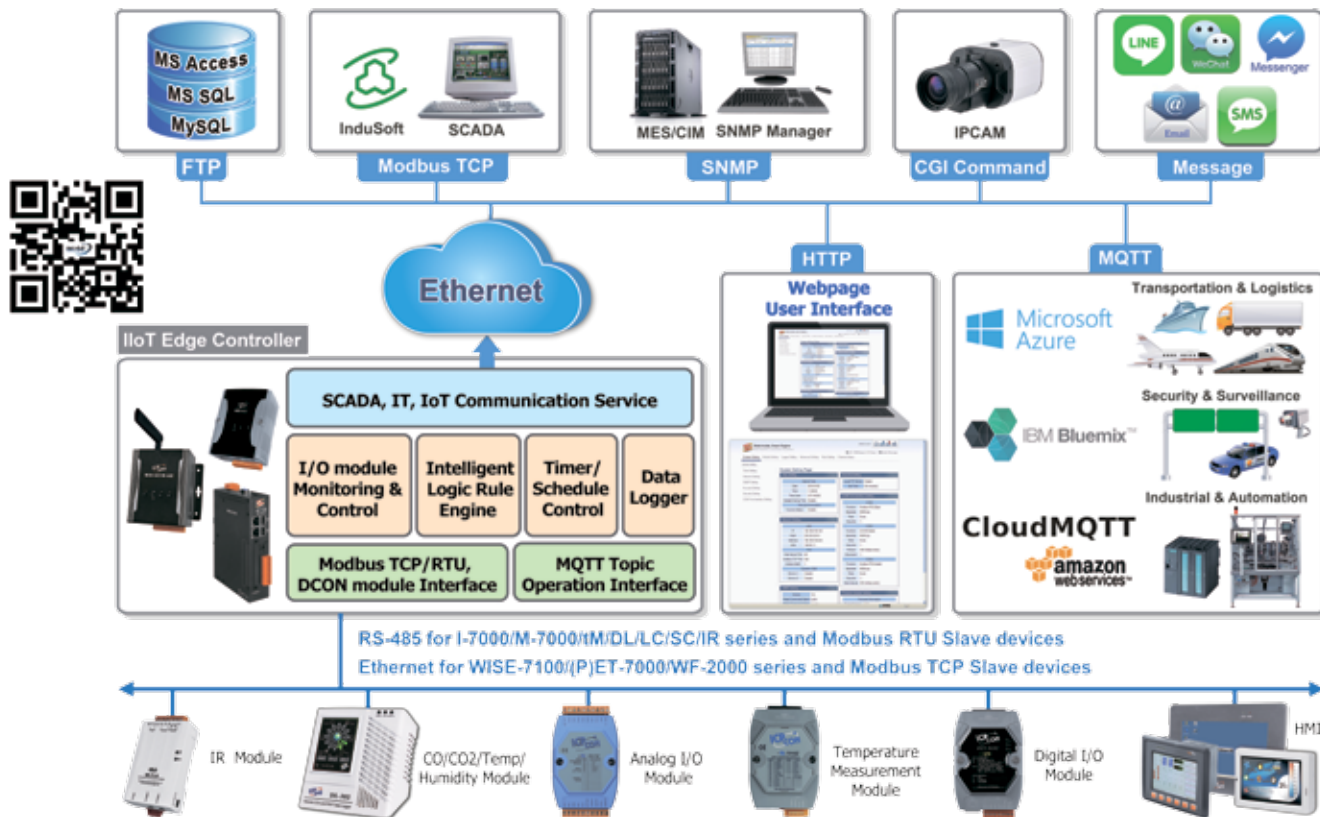

### UA-5231 : IIoT Communication Server

The UA-5200 is an IIoT communication server and a data acquisition controller, built-in OPC UA Server and MQTT Client Service, supports common industrial communication protocols, small size, low power consumption, and often placed in the equipment rooms and case fields. Applying the OPC UA can integrate the I/O products and the third-party devices, import their data to the back-end SCADA management system or the analysis system. Reach to the Industrial 4.0 or IIoT through the MQTT.

- OPC UA Server and MQTT Client Service
- MQTT Broker Inside
- ARM CPU, 1.0 GHz
- Linux kernel 3.2.14 OS
- Real-Time Capability
- 64-bit Hardware Serial Number for Software Protection
- Support Redundancy (OPC UA) and PID
- 10/100/1000 Mbit/s Ethernet Port
- 4 Serial Ports (RS-232/RS-485)
- Wide Operating Temperature Range: -25°C ~ +75°C

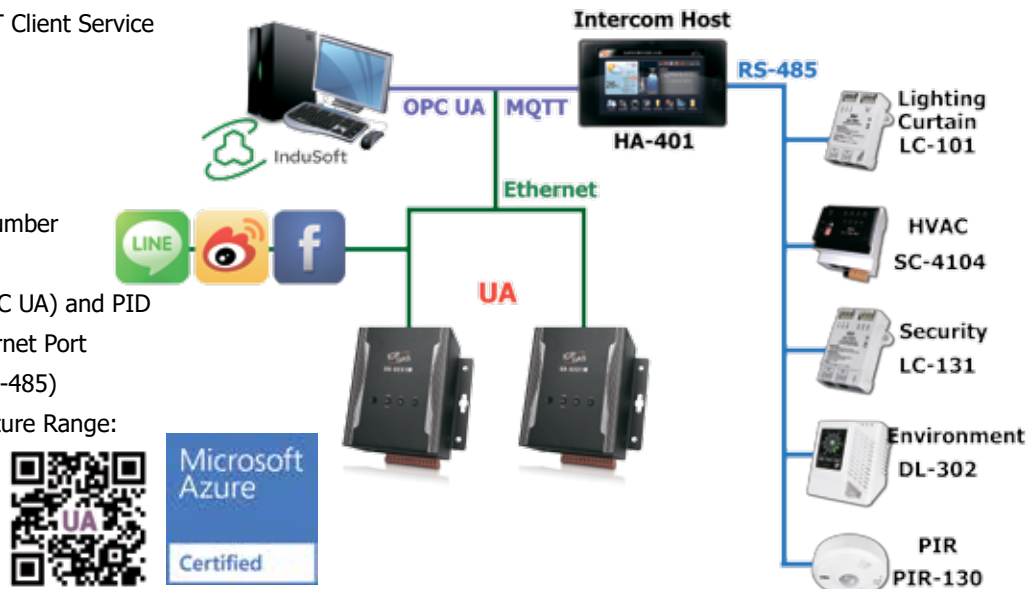

## ZT-2570/ZT-2571 : ZigBee Data Concentrator (Wireless)

The ZT-257x module is a series of data concentrator built-in the I/O Pair-connection Group (IOG) function. With ZigBee wireless communication and remote active I/O features, the ZT-257x module can manage devices' DIO states in the buildings to exchange and update the I/O channels actively. In addition, the ZT-257x also provides Ethernet, RS-232 or RS-485 communication interface, so that the multiple monitoring hosts in different locations can read/write the DIO states of the devices that dispersed over many places through the nearby ZT-257x via the Modbus protocol. It is a data concentrator that no need to programming and no dealing with the wireless communication interference, but can quickly establish, monitor and manage the I/O pair-connection with the decentralized DIO channels. It suits the multi-host monitoring and I/O Pair-connection wireless applications for the environment of needing many I/O points, wide communication range and not easy wiring.

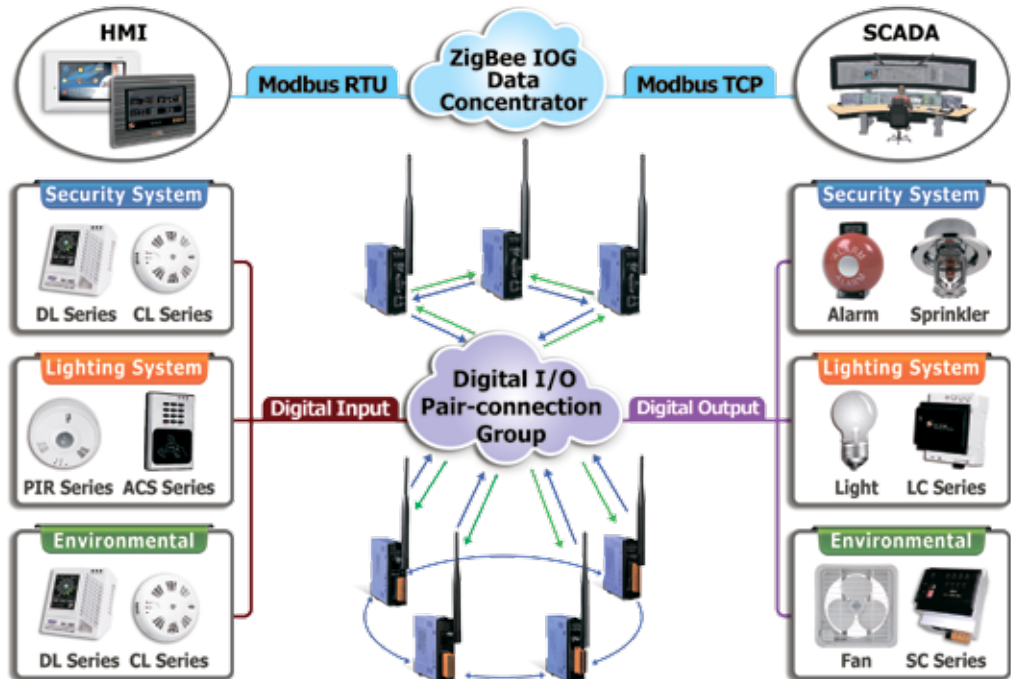

## MDC-700 : Modbus Data Concentrator (with IoT Service, MQTT Client)

MDC-700 series is a Modbus Data Concentrator used to access data from disparate Modbus slave devices with a contiguous Modbus address table ranged by the concentrator. The Modbus TCP masters directly read/write the data in the MDC-700 instead of polling each Modbus RTU slave device one by one. This way makes the data on the RS-232/485 shareable to multiple Modbus TCP master and also shorten the time to read/write data from/to multiple Modbus RTU slave devices. Editing the Modbus RTU commands for accessing the Modbus RTU slaves is simple and convenient with Comma Separated Values (CSV) format. In addition, a web-based user interface is provided to configure the concentrator and remotely monitor the state of the connection of Modbus RTU slaves.

- Web-based User Interface
- Easy Configuration with .CSV File
- Support for up to 8 Modbus TCP Masters
- Great Capability of Shared Memory
- Communication Protocols:
  - Modbus RTU/TCP Slave
  - Modbus RTU Master
  - MQTT v3.1 Client (Available soon)
- Accelerate Reading Time from Multiple Devices
- Upgrade Devices with Ethernet Communication

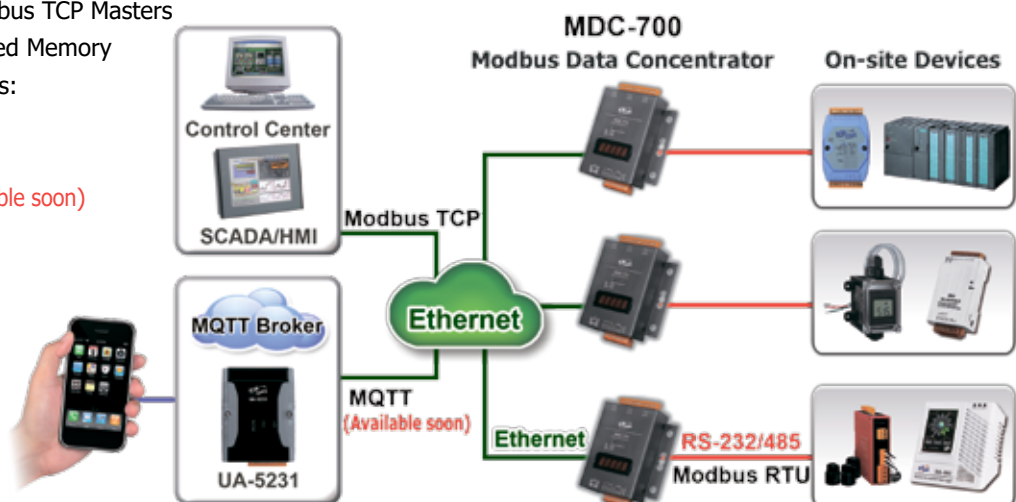

# 3-14 WISE Surveillance Solution: WISE IIoT Edge Controller + iCAM IP Camera

A general surveillance system on current market usually features separated systems: the camera DVR/NVR as a system, and the I/O monitoring as another system; each system operates independently. For now the DVR/NVR system of the camera usually records video for 24H/7Day without interruption, it requires huge storage space and sufficient network bandwidth; therefore the system implementation fee is usually high. In addition, when playback a certain video, it does not allow to search the suspicious activities of related I/O (temperature, doors and windows switch, water level, etc.) at the same time.



ICP DAS WISE surveillance solution integrates logic control, I/O, camera and data log in one single WISE controller. WISE allows two-way interactions between the I/O and the camera; it enables to record a piece of video or to take images when there is an event triggered by either I/O condition or ROI (Region of Interest) by camera. In this way, the storage size can be reduced significantly and the connection between I/O event and Video/Image can be built for easy query.

ICP DAS WISE Surveillance Solution	Regular Surveillance Solution
1. One WISE controller to integrate camera and I/O	1. Two independent systems: SCADA & DVR/NVR
2. Records key video and image, only needs a few storage memory.	2. Record video 24H/7Days, needs huge storage memory.
3. Two-way interaction between I/O and Video/Image	3. I/O and Video/Image are independent
4. Work stand alone or be integrated into a SCADA system	4. Needs a host PC to run the SCADA
5. One stop shopping/service for <ul style="list-style-type: none"> <li>● Controller: WISE Series</li> <li>● I/O Modules: Various options for RS-485, Ethernet interfaces</li> <li>● Camera: Bullet, Fisheye, Dual Lens</li> <li>● SCADA: InduSoft</li> </ul>	5. Buy from different vendors for SCADA, I/O Modules, DVR/NVR

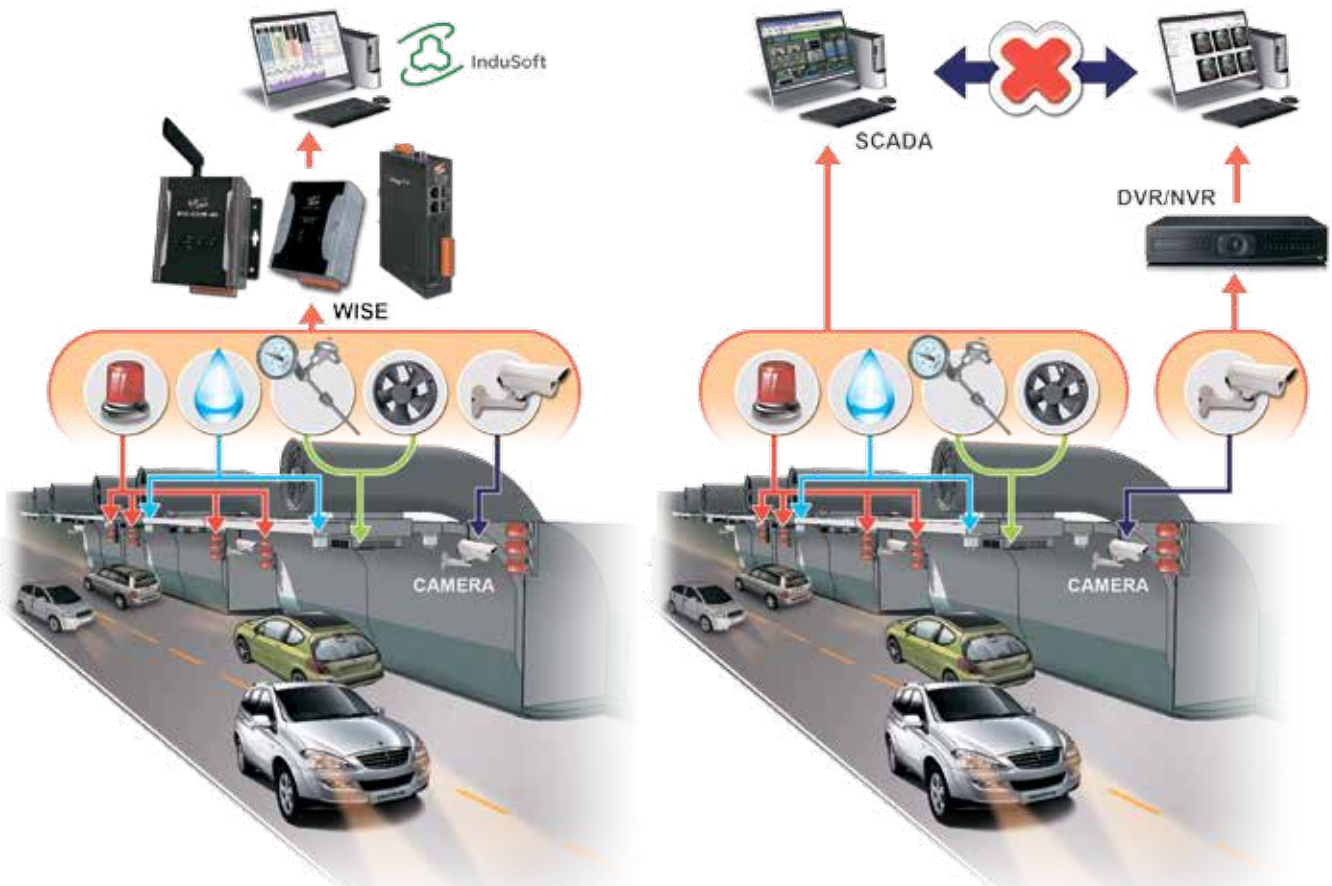

Product Series



# WISE Introduction

WISE (Web Inside, Smart Engine) is a product series developed by ICP DAS that functions as control units for use in remote logic control and monitoring in various industrial applications. WISE offers a user-friendly and intuitive web site interface that allows users to implement IF-THEN-ELSE control logic on controllers just a few clicks away; no programming is required. With its powerful and easy-to-use features, it will minimize the learning curve, shorten time to market and dramatically reduce the labor and cost spent on system development.

## WISE System Architecture



## IF-THEN-ELSE logic rules execution ability

WISE controller features an IF-THEN-ELSE logic rule engine; it offers IF-THEN-ELSE rules for users to set up the logic content. After completing rule edition and downloading rules to the WISE, the rule engine will loop execute the rules in accordance with the execution order under specific conditions.



### IF Condition

- DI
- AI
- Timer
- Schedule
- SD card Status
- I/O Module
- Connection Status
- CGI Command/MQTT Message receive

### THEN/ELSE Action

- DO
- AO
- System Reboot
- CGI Command Sending
- Data Log
- SNMP Trap Sending
- Email Sending
- MQTT Message Sending
- SMS Sending
- Instant Message Sending

Product Series

### Support LINE, WeChat, SMS and Email sending functions

WISE-523x/WISE-224x supports LINE, WeChat, SMS, and Email sending function for real-time message notification. The message sending action can be added to the logic edition as part of logic control to provide real-time message notification to the related personnel when an event occurs. In addition, when WISE-523x/ WISE-224x connects with ICP DAS iCAM series IP cameras, WISE can send the pictures and videos to the manager by LINE and WeChat.



### Provide Timer and Schedule operation

WISE features Timer and Schedule functions: It allows user to schedule specific date or time for control logic execution, or perform specific tasks such as time delay. With calendar user interface provided, Schedule setting can be more efficient and flexible.

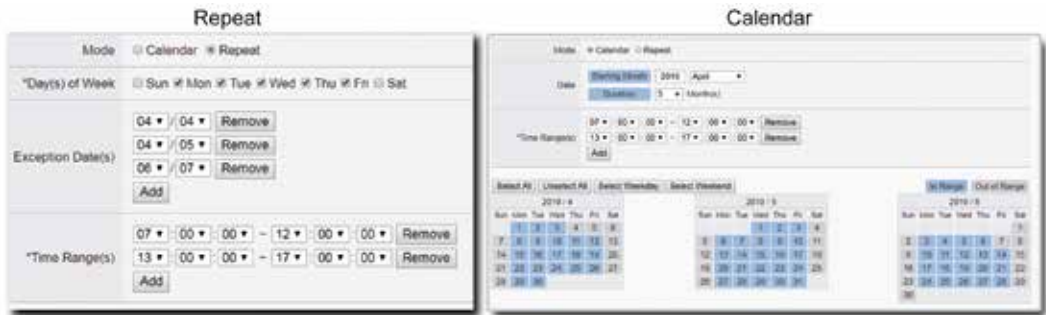

Product Series



## Well-thought-out CGI command operation with IP Camera

WISE supports full CGI command operations - CGI command sending and CGI command receiving. The CGI command sending action can be added to the logic edition as part of logic control in response to specific events. The CGI command receiving function enables WISE to receive the CGI commands from others network devices. The content of CGI command received can be used in IF condition statements to trigger the THEN/ ELSE actions.

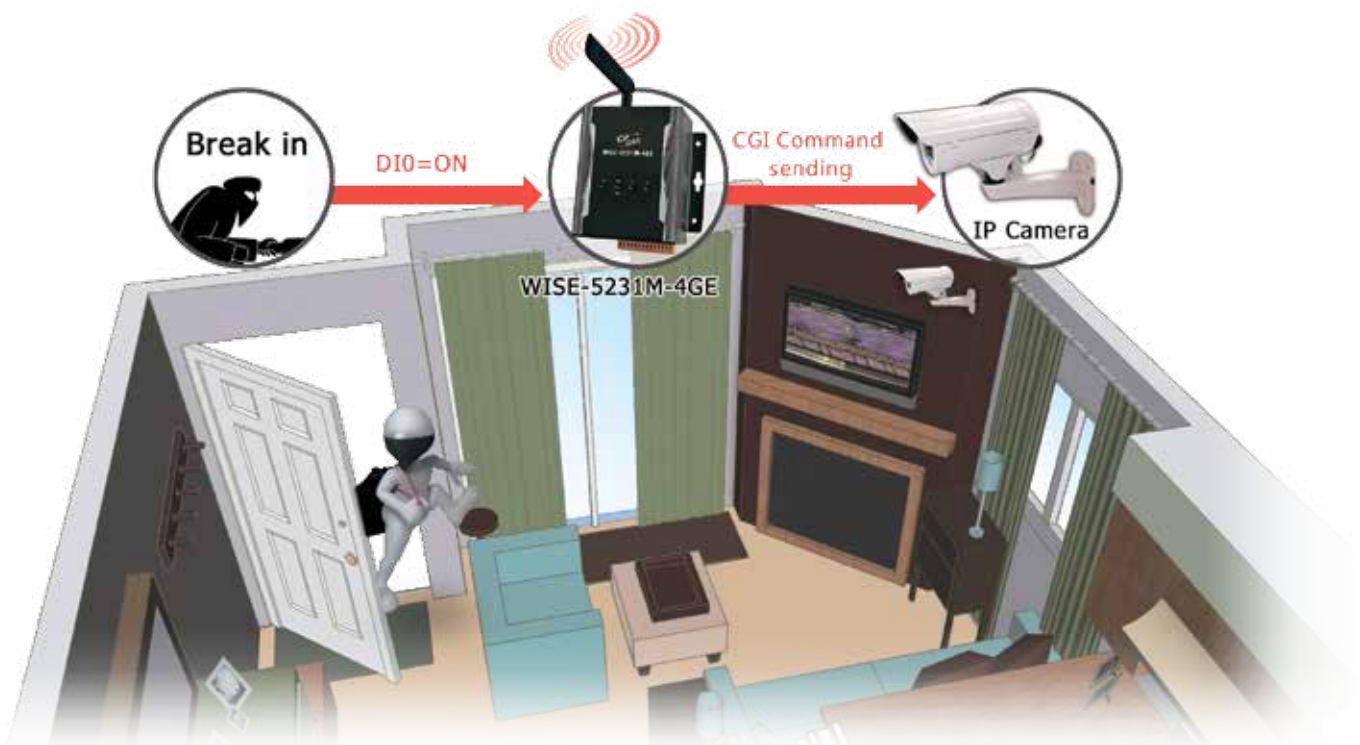



## Auto Focus IR IP Bullet Camera



### iCAM-ZMR8422X

Bullet Type / Auto focus with zoom

#### Features

- Full HD 2.0 megapixel CMOS image sensor
- 1080P True H.264 AVC High Profile video compression
- H.264 and Motion JPEG multi-profile video streaming
- Auto focus with zoom / focus motorized lens
- 3D noise reduction (MCTF), 2D WDR function
- HDR function up to 100dB
- Digital PTZ and ROI (Region of Interest) supported
- Day & Night IR-cut removable LED, radiant distance up to 30m
- Built-in 4GB MicroSD Card
- ONVIF Profile S supported
- IP67-rated Housing



#### Introduction

**iCAM-ZMR8422X** is a day & night 2MP auto-focused vandal resistant bullet IR IP camera. It features a full HD 2.0 megapixel CMOS image sensor. The camera has built-in IR-cut filter which allows clearer images at day and night operations even in the low lux condition.

The high efficiency IR LED radiant distance can extend up to 30 meters. Its auto-focus feature allows users to automatically focus the camera from a distant location. With motorized lens, all you need to do with zoom/focus adjustments is simply a click on browsers. Support with privacy mask, 3D noise reduction, 2D WDR function, and HDR function up to 100dB, it's easier implement iCAM-ZMR8422X into a range of environments such as retail, home, office, residential premises and hotel security.

## Vari-Focal IR IP Dome Camera



### iCAM-MR6422X

Dome Type / Vari-Focal

#### Features

- Full HD 2 megapixel CMOS image sensor
- 1080P True H.264 AVC High Profile video compression
- H.264 and Motion JPEG multi-profile video streaming
- 3-Axis construction / Smart H.264 supported
- 3D noise reduction (MCTF), 2D WDR function
- HDR function up to 100dB
- IR cut filter for day/night operations, radiant distance up to 30m
- Built-in 4GB MicroSD Memory Card
- ONVIF Profile S supported
- IP67-rated Housing



#### Introduction

**iCAM-MR6422X** is 30M-Range IR Varifocal Dome IP Camera which has built-in Sense up+ technology to deliver stunning video in low-light conditions. It features 1080p at 30 frames per second and intelligent video surveillance (IVS) functions. Utilizing intelligent image signal processing, HDR, AGC control, and 3D Noise Reduction, the combination successfully delivers the ultimate low-light image without motion blur.

iCAM-MR6422X support PoE, privacy masking, white balance, as well as the minimum illumination 0.117 Lux at F1.4 can certainly satisfy multiple applications.

## Fixed IR IP Dome Camera



### iCAM-MR6322

Dome Type / Fixed

### Features

- Full HD 2 megapixel CMOS image sensor
- 1080P True H.264 AVC High Profile video compression
- H.264 and Motion JPEG multi-profile video streaming
- Smart H.264 supported
- 3D noise reduction (MCTF), 2D WDR function
- HDR function up to 100dB
- IR cut filter for day/night operations, radiant distance up to 30m
- Built-in 4GB MicroSD Memory Card
- ONVIF Profile S supported
- IP67-rated Housing



### Introduction

**iCAM-MR6322** is 30M-Range IR Fixed Dome IP Camera built-in Sense up+ technology to deliver stunning video in low-light conditions. It features 1080p at 30 frames per second and intelligent video surveillance (IVS) functions. Utilizing intelligent image signal processing, HDR, AGC control, and 3D Noise Reduction, the combination successfully delivers the ultimate low-light image without motion blur.

iCAM-MR6322 support PoE, privacy masking, white balance, as well as the minimum illumination 0.13 Lux at F2.0 can certainly satisfy multiple applications.

### Support Android & iOS Mobile APP

**iCAM-ZMR8422X/iCAM-MR6422X / iCAM-MR6322** provide smart phone APP for Android and iOS platform. Apps allow you to catch the firsthand notifications and to take over all event situations in real-time. Furthermore, using the App can also allow you to reward the recorded video remotely. While the alarm is triggered, App will send a notification message to the user immediately.

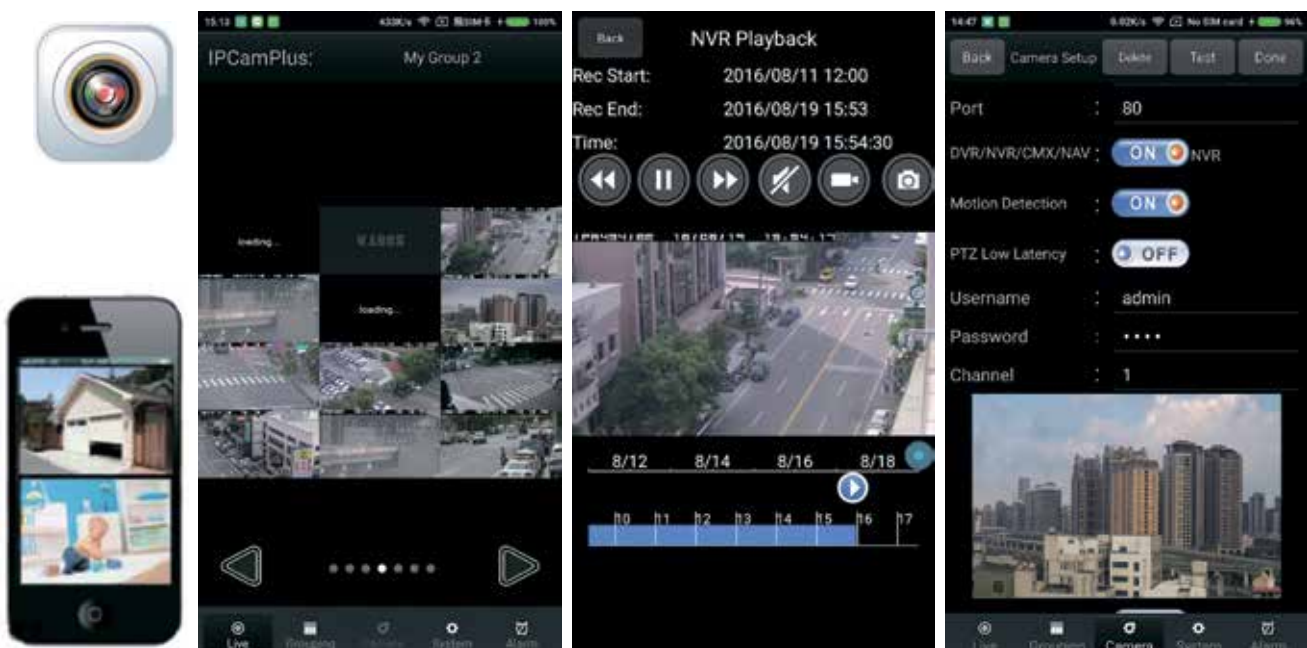

## Bullet Network Camera



**iCAM-721F**



### Introduction

**iCAM-721F** is a professional bullet camera offering 1080p Full HD resolution with super image quality up to 30 fps. Featuring 3-Megapixel resolution and high-performance H.264/MPEG-4/MJPEG compression technology, iCAM-721F offers extra-smooth video and wide coverage.

iCAM-721F has many advanced features to make users fully utilizing the high resolution video. Focus on a region of interest (ROI) in the camera view to enhance image quality. It also lowers the cost of network bandwidth and backend storage of video streaming.

Aimed at outdoor surveillance, iCAM-721F is furnished with an auto-aperture lens, a removable IR filter, 15-meter IR illuminators, Wide Dynamic Range (WDR), and multi-functional environment profile image settings for superior image quality around the clock. Moreover, the IP67-rated housing protects against humidity and dust ensures functional operation in all types of weather conditions.

With other advanced features such as 802.3af compliant PoE, ONVIF Compliant for interoperability, built-in SD/SDHC/SDXC card slot for storage, two-way audio, and digital input / output for alarm, the iCAM-721F is an all-in-one bullet network camera for detailed surveillance in outdoor environment.



## IR Fisheye Network Camera



**iCAM-771**



**360° Panoramic View**



**180° Panoramic View**

### Introduction

**iCAM-771** is a Fish-eye IR Network Camera, featuring a detailed 5-Megapixel resolution sensor with clear image quality. Equipped with a fish-eye lens for 360°/180° panoramic view without blind spots, certified ImmerVision Enables 2.0, the cameras are able to provide coverage of wide, open areas, such as airports, shopping malls, factories, parking lots, retail stores, offices and etc.

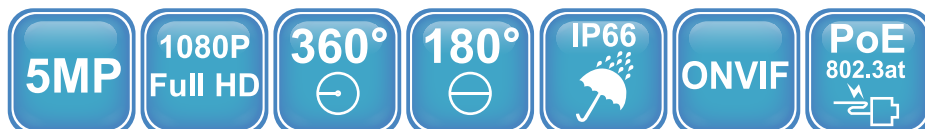

Product Series



# Dual Lens Panoramic Dome Network Camera

## iCAM-760D



iCAM-760D  
with outdoor  
6" dome housing

### Features

- 2 x 5 Megapixel Progressive CMOS Sensor
- Smooth 15 fps@High 7.3 Megapixels Resolution (3840 x 1920)
- H.264/MJPEG Dual Codec
- 1.05 mm non-linear Fisheye Lens + 6/8/12/16 mm Fixed-focal Lens
- Removable IR Cut, Day & Night Function for Both Sensors
- eWDR Image Enhancement for Extreme Lighting Condition (too Bright/Dark)
- Various Display Modes Selectable for Different Applications
- ePTZ, Auto Pan, Auto Patrol Function on Fisheye Lens
- Two-way Audio
- Built-in microSD / microSDHC / microSDXC Card Slot for On Board Storage
- Weather-proof IP66-rated Outdoor Housing
- Built-in 802.3af Compliant PoE
- ONVIF 2.2 Compliant for interoperability

### Introduction

**iCAM-760D** dual lens camera provides a professional camera solution. Integrated with Dual 5-Megapixel sensors, one equipped with f 1.05mm non-linear fisheye lens offers 180/360 degree de-warped image (single or multiple), for the other sensor, lens is 6, 8, 12, 16mm optional. Dual sensors gimbals work independently and can be configured to almost any direction, and de-warping algorithms are 180/360 degree selectable depends on fisheye lens configuration. Wide Dynamic Range and IR cut removable are available for both sensors. iCAM-760D offers a professional and efficient solution for commercial, industrial, and public areas.



**360° Panoramic View + Fixed-focal View**

**180° Panoramic View + Fixed-focal View**



**180° Triple View + Fixed-focal View**

**Quad View + Fixed-focal View**

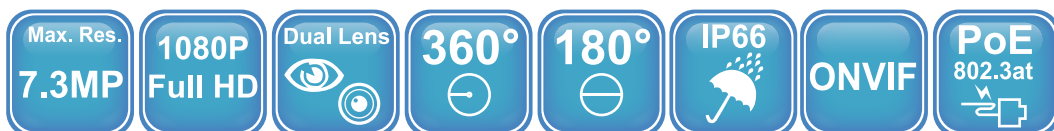

# 3-15 Smart Access Control:

## WISE IIoT Edge Controller + Access Control Reader + Camera + Alarm



ICP DAS Smart Access Control System can solve problems of traditional systems. In traditional systems, the controllers need to be developed by professional software engineers, and the control projects need to collect all statuses of the sensors and handle the communication of the I/O modules. When expanding the system in the future, it needs a lot of human power and time to modify the projects, which costs more and gets poor benefits. Moreover, the integration is not easy due to the sensors and image monitoring are mostly separated.

The WISE-523x/WISE-224x edge controllers in the ICP DAS Access Control System support I-7000/M-7000 I/O modules in default and no programming is required to implement logic content to display the sensor status of the I/O modules on the webpage. The WISE has built-in IF-THEN-ELSE Logic Rule Engine, which can be easily selected on the webpage to complete the access control system. More importantly, the WISE also supports two-way CGI command communication mechanism, which can easily integrate IP camera images.



Product Series



**Using ACS series card reader to connect M-7000 I/O to achieve multi-group alarm loops**

1. Multi-condition door access: Supports 3 conditions for door opening card only, password only, or card + password. It can be configured using an access control application or attendance application.
2. Provides the PC software for authorization and password management, and supports updating card recorder information to a remote database via an Ethernet connection.
3. Supports electric door lock control and allows you to connect this via an M-7000 I/O module to detect trigger conditions for the WISE if-then-else logic control.
4. WISE supports most M-7000 I/O modules, so you can select a module from the supported list that can be found on the WISE WEB page, and WISE will automatically create the corresponding WEB UI and handle the communication, meaning that you can directly obtain the module data from the WISE WEB page.

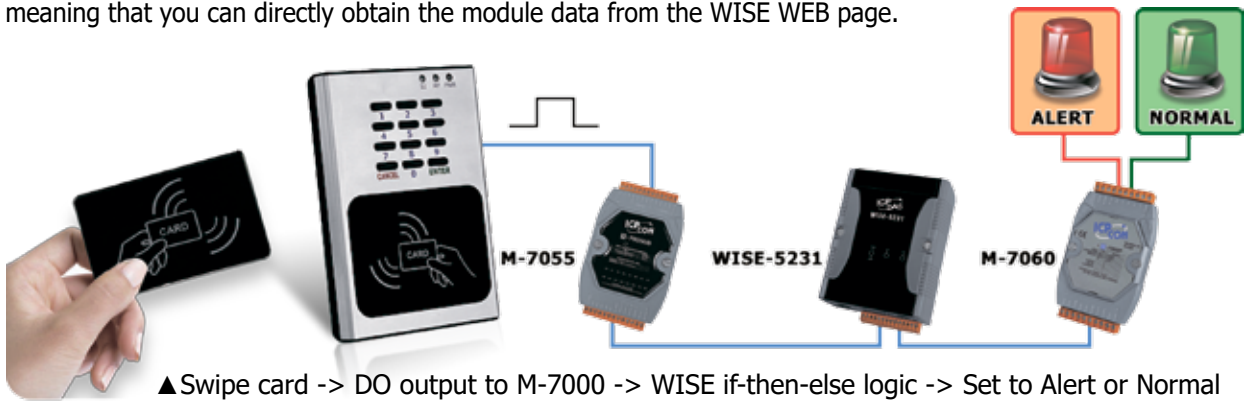

**WISE provides logic control to achieve the access control, camera capture and the alert notify of the mobile phone**

1. The WISE logic control function can set the status of I/O module as a logical control condition: Using the WISE logic control function can implement the access control function easily by clicking on the webpage without any additional programming.
2. WISE uses CGI commands to let iCAM capture images with the simple and fast setting.

**Rule Information Setting**

\*Nickname: Alarm 6 - Snapshot

Description: The office of Chief financial officer - Door

Status:  Enable  Disable

**Rule Content Setting**

IF	THEN	ELSE
<p>AND</p> <p>Add a new Condition: Set up a Condition</p> <ul style="list-style-type: none"> <li>Local Internal Register 2 (Internal Register 2) = 1</li> <li>COM4 I-7055(3) DI2 = ON</li> </ul>	<p>Add a new Action: Set up an Action</p> <ul style="list-style-type: none"> <li>CGI Command(Alarm Snapshot:CGI Command 1) Send</li> <li>COM4 I-7055(3) DO5 = ON</li> </ul>	<p>Add a new Action: Set up an Action</p> <p>No Action exists</p>

Save Cancel

Product Series



# 3-16 IIoT and Smart Phone Integration Solution

## WISE IIoT Edge Controller

+ I/O & Sensor + Camera + APP



The **WISE-523x/WISE-224x** series is the **IIoT Edge Controller** designed by ICP DAS for industrial IoT application. In addition to the simple, easy-to-use, flexible and full-featured features of the past, the new features were introduced in January 2018. The I/O data and pictures taken by the camera can be instantly pushed to the LINE/WeChat contacts and chat rooms on the smart phone.



Product Series

# WISE message notification to smart phone

## ● SMS : Sends alert messages and receives commands

- ▶ The same SMS can be sent to multiple phone numbers
- ▶ The same SMS can include multiple variable values (SMS < 160 characters)
- ▶ Phone number must be authorized to send SMS commands



## ● LINE/WeChat: Sends alert messages and picture

- ▶ **Object: Contact, Chat Room**

### ▶ Content:

	LINE	WeChat
Text	1000 / hour	6000 / day, Expandable
Picture	50 / hour	
Film	N/A	



### ▶ When:

- ▶ Triggered by WISE If-Then-Else rules
- ▶ Triggered by camera motion detection

**[Rule 1] Warehouse temperature (35.2°C) is over the high limitation, fan is turned on.**

**[Rule 3] Camera motion detection for the front door.**

**[Rule 2] The door is opened.**

### 📌 WeChat Function Using Note:

An Enterprise WeChat account in China is required for WISE to send the messages to the members under the enterprise WeChat account.

## 📌 Ordering Information:

WISE-5231	IIoT Edge Controller, Support LINE APP, Ethernet
WISE-5231M-3GWA	IIoT Edge Controller, Support LINE APP, Ethernet, 3G Wireless (WCDMA)
WISE-5231M-4GE	IIoT Edge Controller, Support LINE APP, Ethernet, 4G Wireless (FDD LTE)
WISE-5231M-4GC	IIoT Edge Controller, Support LINE APP, Ethernet, 4G Wireless (FDD, TDD LTE)
WISE-2241M	IIoT Edge Controller, Support LINE APP, Ethernet
WISE-5236	IIoT Edge Controller, Support WeChat APP, Ethernet
WISE-5236M-4GC	IIoT Edge Controller, Support WeChat APP, Ethernet, 4G Wireless (FDD, TDD LTE)
WISE-2246	IIoT Edge Controller, Support WeChat APP, Ethernet

## 📌 More:

- WISE introduction and live demo: <http://wise.icpdas.com>
- RS-485 remote I/O module: M-7000 series

# 3-17 Facial Identity System

## Smart Facial Identity



Model: advanVD1

The traditional monitors need to detect the abnormalities in the picture by the human eye and then react. If the duty officer is negligent in some moment, it may cause regrets. However, the smart camera can directly identify the photographed person on screen is in the blacklist or a suspicious stranger, and then make the appropriate decisions within 2 seconds, such as, to notify the security officer, lock the door, etc. The smart camera with facial identity can make our life more safety.

## Artificial Intelligence Replaces Traditional Manpower

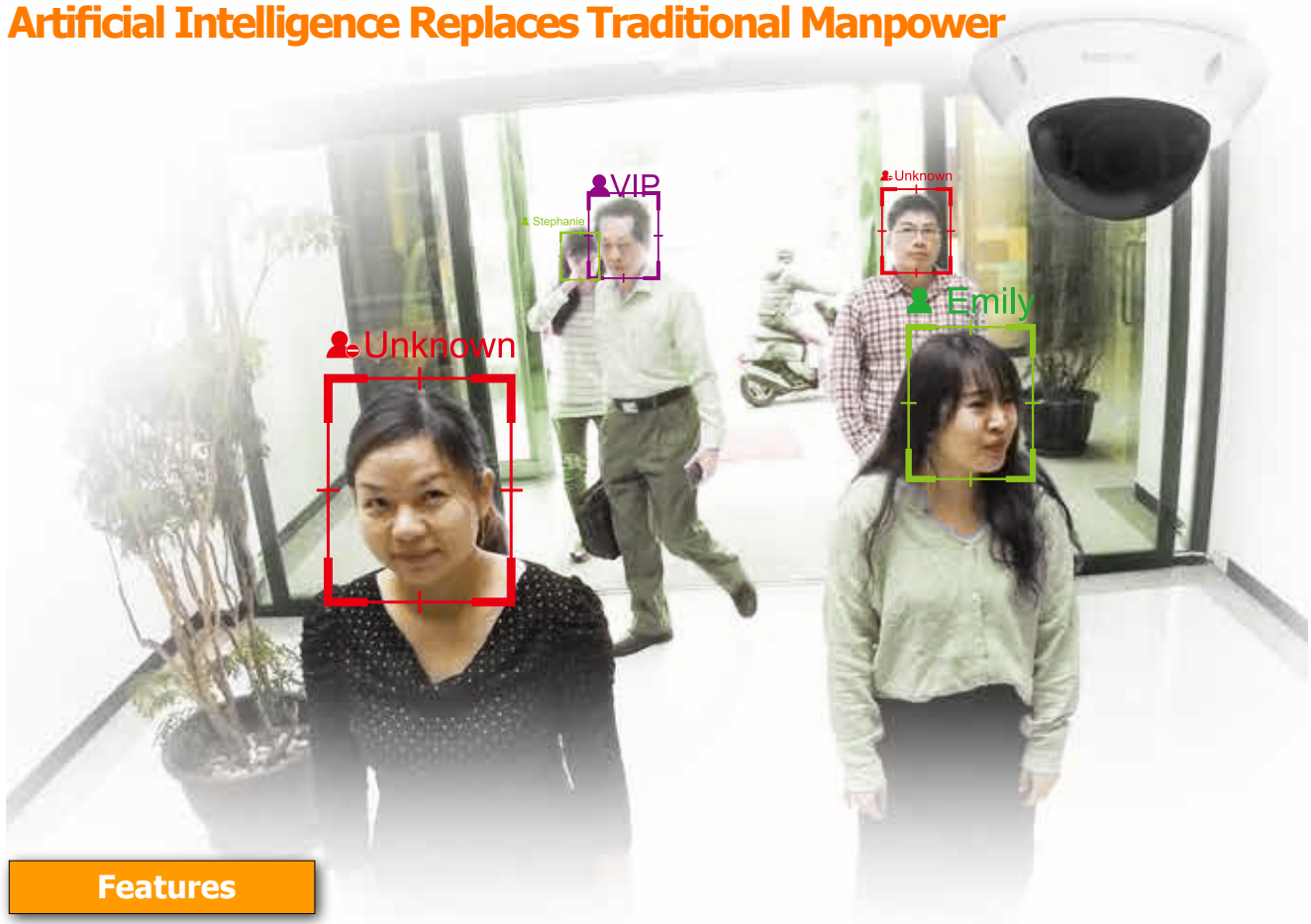

Product Series

### Features

**1.5 S**  
UP TO 8 PEOPLE

**BLACKLIST**

**WHITELIST**

**NO PC**



## Free Software: FaceGate App

Support

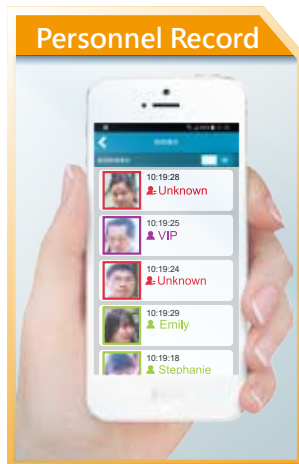

## IoT System Guards The Home Security

The IoT (Internet of Things) intelligent security system can transmit the instant dynamic messages to the cloud, and the cloud then integrates the messages to the smartphone with the FaceGate APP. Therefore, the users can receive information anytime and anywhere, and the administrators and guards can respond to any situation as soon as possible.

### Application Field

Homes, communities, schools, hospitals, companies, factories, department stores, banks, bank's vaults, airports, prisons, cantonments, superstor, insurance companies, supermarkets, stations, etc.

# 3-18 iKAN Series: Industrial LED Message Display



iKAN-116S/iKAN-124S



iKAN-116/iKAN-124



iKAN-208/iKAN-216/iKAN-224

## Features



- Support multiple languages: text height of 16/11.5 cm
- 7 colors, including red, blue, yellow, green, light blue, purple and white
- Able to store up to 128 messages with priority configuration
- Convert 8 Modbus numbers into ASCII messages Instantly
- Integrate both text and variables in a single message
- Support Modbus TCP/RTU/CGI protocols
- Built-in RTC (Real Time Clock )
- Web-based User Interface
- Can be remotely controlled via a PLC, PC, or smart phone



## Introduction

The iKAN series is a family of industrial Modbus LED message display devices that deliver industrial-grade anti-noise capabilities as well as reliability and stability. ASCII characters and Unicode characters, which can be used to display multiple languages, are supported for presenting formatted messages. Support for the popular Modbus industrial protocol is provided meaning that iKAN display devices can easily integrate into existing PLC and SCADA environments. The iKAN series allows data written from a PC or a PLC to display on a formatted message in real-time. Seven colors are available for the text, which can be used to indicate different degrees of importance of the message, as well as significantly increase the readability of the message in an industrial arena.

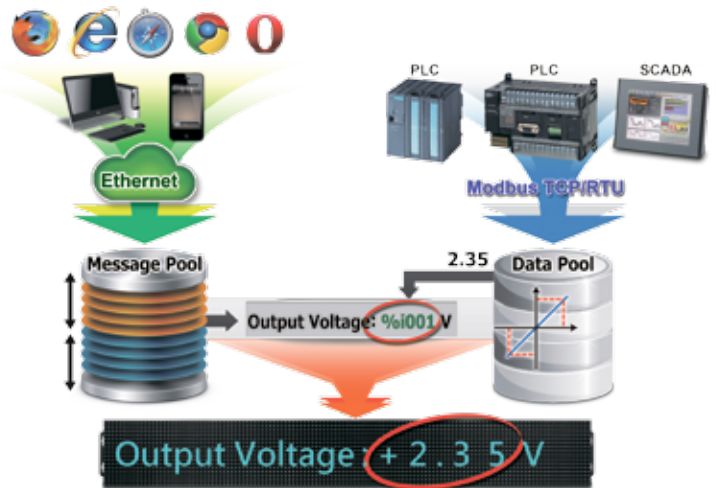

### Built-in RTC

Date and time, 24 hour format including second, minute, hour, date, day of the week, month, year.



### Smart Phone Controllable

Messages can be edited using a standard web browser on a PC, mobile device, or smartphone without any limitations related to specific control tools or programs.



### IP65 Rating

The iKAN IP65 model is totally waterproof and dustproof so it can be installed in dirty, soiled, or semi-outdoor environments, such as eaves, open halls, outdoor canopies, or beneath a sunroof.

### Support Modbus TCP/RTU protocols

The popular Modbus industrial protocols are provided. iKAN can be easily integrated into PLC/SCADA.

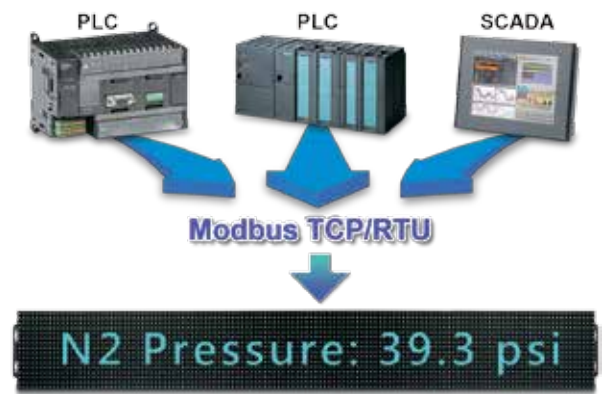

### Indoor Air Quality Display

The iKAN device can be used to display indoor air quality monitoring data from ICP DAS DL sensor modules, including details of the CO, CO2, and PM2.5 levels, the temperature, and the humidity, without requiring any programming skills or knowledge.



### Message Editing

#### • Edit default messages:

A maximum of 128 messages with priority can be preconfigured from the first moment that the iKAN display is switched on. When the display is in operation, the focus needs only be on message management rather than the need to frequently update the messages.

#### • Convert 8 Modbus data into ASCII character messages Instantly:

8 Modbus control registers sets can be assigned to 4 messages; each of which contains up to 64 ASCII characters. It allows the Modbus controller to write text message to be displayed on the iKAN device.



### Message Priority

Messages with instant priority have a higher priority than other messages. Once a message with instant priority is enabled, the common message currently being displayed will be suspended until the instant message is disabled. This feature allows the most important information to be displayed in an emergency situation.

## Selection Guide

**iKAN** - **X** - **XX** - **S** - **IP65**

**Lines**  
1: Single Line  
2: Two Lines

**Characters (1 Line)**  
08: 8 Characters  
16: 16 Characters  
24: 24 Characters

**LED Size**  
S: Small Size  
Null: Normal Size

**IP Rating**  
Null: None  
IP65: IP65

Model	iKAN-116	iKAN-116S	iKAN-124	iKAN-124S	iKAN-208	iKAN-216	iKAN-224
Display							
Text Color	Blue, Red, Yellow, Green, Light Blue, Purple or White						
Character Sets	16-bit Unicode or 7-bit ASCII						
Message Pool	128 common messages with user-defined priority levels Up to 20 Unicode characters or 50 ASCII characters each						
Data Pool	40 Coil values, 64 Float values, and 64 Integer values						
Communication Interface							
Ethernet	2 × RJ-45, 10/100 Base-TX Modbus TCP Master/Slave, Max. 8/8 connections, Web-based User Interface						
COM Port	2 × RS-485 (Modbus RTU)						
Mechanical							
Dimensions (W x H x D) (mm)	1346 × 160 × 49	834 × 115 × 37.5	1986 × 160 × 49	1218 × 115 × 37.5	707 × 320 × 50	1346 × 320 × 49	1986 × 320 × 49
Weight	4 Kg	2 Kg	4.6 Kg	2.5 Kg	4 Kg	8 Kg	12 Kg
Housing Material	Aluminum						
Power Input Range	100 VAC ~ 240 VAC						

Product Series



# 3-19 Accessories

## Enclosures and Mounting Kit

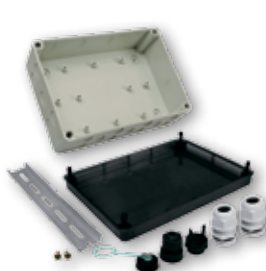

**I-36166-ENC**

**I-25091-ENC**

**I-25140-ENC**

**I-25166-ENC**

Models	I-36166-ENC	I-25091-ENC	I-25140-ENC	I-25166-ENC
<b>Includes</b>	Case Accessory			
	2 × cable glands: 4PASO-0028 (Cable Range $\Phi 9 \sim 14$ mm)			
	1 × cable glands: 4SASO-0007 (Cable Range $\Phi 7 \sim 4$ mm)			
	6 × captive lid screws	4 × captive lid screws		
	1 × DIN-Rail (34 cm)	1 × DIN-Rail (20 cm)		
<b>Mechanical</b>				
Casing	Plastic			
Dimensions (W × H × D)	361 × 254 × 166 mm	255 × 181 × 91 mm	255 × 181 × 140 mm	255 × 181 × 166 mm
<b>Environmental</b>				
Temperature	0 ~ +50°C for Protection rating IP66			

## Battery Box



**BX-ENEL5-1**

**BX-ENEL5-1 Battery box:**  
 Battery box for Nikon EN-EL5 type of battery with DIN rail mounting kit and one 15 cm length cable.

## 19" Rack Mounting Kit, 3U



**RK-3UD-R**

### Specifications:

<b>Mechanical</b>	
Dimensions (W × H × D)	481 × 132 × 125 mm

## Magnetic Accessories

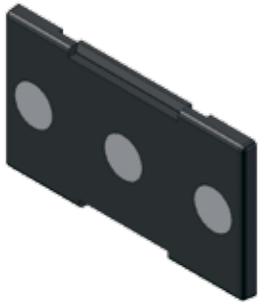

**I-WM01-ENC-K**



**I-WM02-ENC-K**

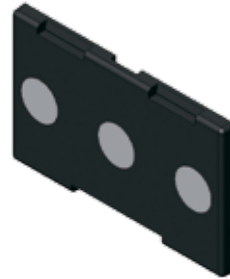

**I-WM03-ENC-K**



**I-WM04-ENC-K**



For 7000 plastic case  
or 7000 with DIN-Rail  
mechanism



DIN-KA52F, DIN-KA52F-48



For tiny series  
with DIN-Rail  
mechanism



Only for DIN-Rail  
mechanism



For DL-100 series  
with DIN-Rail  
mechanism



For DL-300 series  
with DIN-Rail  
mechanism





## Energy Management Solution

- InduSoft SCADA Software
- Smart Power Meter Concentrator
- Smart Power Meter
- True RMS Input Module
- TouchPAD Devices - VPD Series



## IIoT Product

- IoTstar : cloud management software
- UA-5200 : communication server
- WISE series : IIoT host
- iCAM series : IP camera
- MQ-7200M series : MQTT I/O module
- Sensors : temperature, humidity, CO2, PM2.5,...



## Industrial Fieldbus

- RS-485
- Industrial Ethernet
- Profinet
- CAN bus
- CANopen
- Devicenet
- J1939
- PROFIBUS
- HART
- Ethernet/IP
- BACnet



## IIoT Cloud Solution - UA SERIES : IIoT Communication Server

- Built-in OPC UA Server Service
- Built-in MQTT Broker Service
- Support Logic Control IFTTT
- Support IoT Cloud Platforms Connection and IoTstar Cloud Management
- IIoT Factory Application of MES
- Pumping Station IoT Application
- BA Smart Building IoT Application
- Robotic Arm Co-operation Application

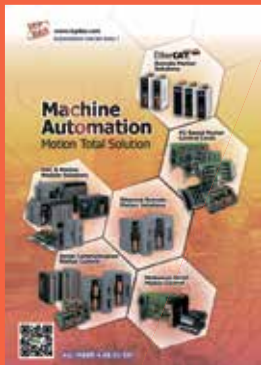

## Machine Automation

- Motionnet Solutions
- EtherCAT Motion Control Solutions
- Ethernet Motion Control Solutions
- Serial Communication Motion Control Solutions
- PC-based Motion Control Cards
- PAC Solutions - Motion Modules



## Wireless Solution

- WLAN Products
- Radio Modems
- 3G/4G Products
- GPS Products
- Bluetooth LE Converters
- ZigBee Products
- Wireless Modbus Data Concentrators
- Bluetooth LE Gauge Master for Mitutoyo Gauges



## TouchPAD HMI Solutions

- Introduction
- TPD/VPD Products Series
- Video Intercom & Access Control Series
- TPD/VPD Application



## PC-based I/O Boards

- PCI Express Bus Data Acquisition Boards
- PCI Bus Data Acquisition Boards
- ISA Bus Data Acquisition Boards

