



tM-AD5

5-channel Isolated Analog Input Module with High Voltage Protection

Introduction

The tM-AD5 is an analog input module that includes 5 differential analog input channels and provides a programmable input range on all analog inputs ($\pm 1\text{ V}$, $\pm 2.5\text{ V}$, $\pm 5\text{ V}$, $\pm 10\text{ V}$). It provides a high overvoltage protection of 120 Vdc. The sampling rate of the tM-AD5 is adjustable and is available in either fast or normal mode and it also provides 4 kV ESD protection as well as 2500 Vrms intra-module isolation.

Applications

- Industrial Automation
- Industrial Machinery
- Building Automation
- Food and Beverage Systems
- Semiconductor Fabrication
- Control Systems

System Specifications

Communication	
Interface	RS-485
Format	(N, 8, 1), (N, 8, 2), (O, 8, 1), (E, 8, 1)
Baud Rate	1200 ~ 115200 bps
Protocol	DCON, Modbus/RTU, Modbus/ASCII
Dual Watchdog	Yes, Module (2.3 seconds), Communication (Programmable)
LED Indicators	
Power	1 LED as Power Indicator
Isolation	
Intra-module Isolation, Field-to-Logic	2500 Vdc
EMS Protection	
ESD (IEC 61000-4-2)	$\pm 4\text{ kV}$ Contact for Each Terminal $\pm 8\text{ kV}$ Air for Random Point
EFT (IEC 61000-4-4)	$\pm 4\text{ kV}$ for Power
Power Requirements	
Reverse Polarity Protection	Yes
Powered from Terminal Block	Yes, 10 ~ 30 Vdc
Consumption	1 W Max.
Mechanical	
Dimensions (W x L x H)	52 mm x 98 mm x 27 mm
Installation	DIN-Rail Mounting
Environment	
Operating Temperature	-25 ~ +75°C
Storage Temperature	-30 ~ +75°C
Humidity	10 ~ 95% RH, Non-condensing

Features

- 5-channel Differential Inputs
- Voltage Inputs
- 120 Vdc Overvoltage Protection
- Resolution: 14/12 bits
- Adjustable Sampling Rate
- 4 kV ESD and EFT Protection
- 3 kV Surge Protection
- Dual Watchdog
- 2500 Vdc Intra-module Isolation
- Cost-effective
- Wide Operating Temperature Range: -25 ~ +75°C



Pin Assignments

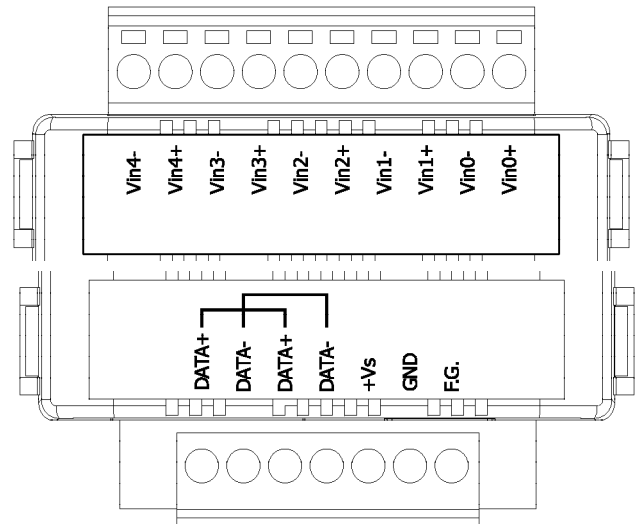

I/O Specifications

Analog Input		
Input Channels	5 Differential	
Type	$\pm 1\text{ V}$, $\pm 2.5\text{ V}$, $\pm 5\text{ V}$, $\pm 10\text{ V}$	
Resolution	Normal Mode	14-bit
	Fast Mode	12-bit
Sampling Rate	Normal Mode	10 Hz total
	Fast Mode	200 Hz total
Accuracy	Normal Mode	$\pm 0.1\%$
	Fast Mode	$\pm 0.5\%$
Zero Drift	$\pm 20\text{ }\mu\text{V}/^\circ\text{C}$	
Span Drift	$\pm 25\text{ ppm}/^\circ\text{C}$	
Input Impedance	20 M Ω	
Overvoltage Protection	120 Vdc	

Wire Connections

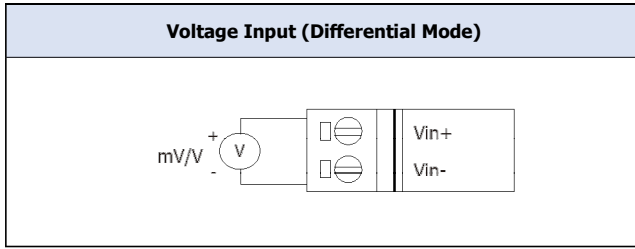

Block Diagram

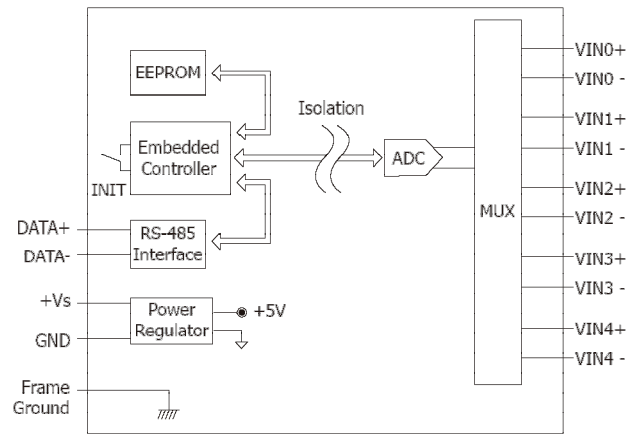

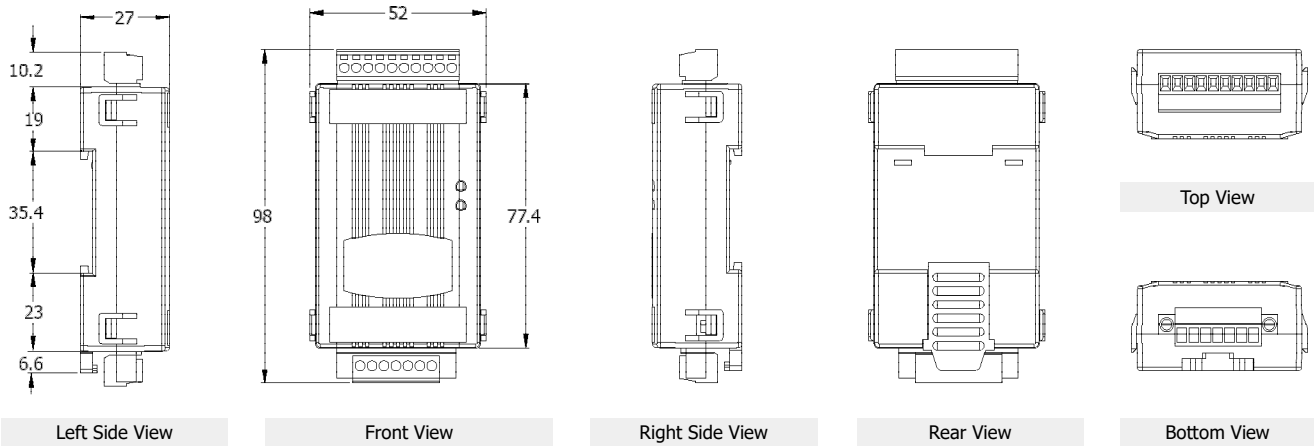

Dimensions (Units: mm)





Ordering Information

tM-AD5 CR	5-channel Isolation Analog Input Module with High Voltage Protection (RoHS)
------------------	---

Related Products

 tM-7561 CR	Isolated USB to RS-485 Converter (RoHS)
 tM-7520U CR	Isolated RS-232 to RS-485 Converter (RoHS)

 tM-7510U CR	Isolated RS-485 Repeater (RoHS)
 MDR-20-24 CR	24W Single Output Industrial DIN-Rail Power Supply (RoHS)