



M-7019Z

10-channel Universal Analog Input Module

Features

- 10-channel Analog Input
- Individual Channel Configuration
- Open Thermocouple Detection
- Temperature Output Consistency
- Stable Temperature Output in the Field
- 240 Vrms Overvoltage Protection
- Jumper Selectable Voltage or Current Input
- 4 kV ESD Protection
- Dual Watchdog
- 3000 Vdc Intra-module Isolation, Field to Logic
- Wide Operating Temperature Range: -25 to +75°C



Introduction

The M-7019Z is a 10-channel universal Analog Input module with an RS-485 interface that is especially designed for extremely accurate thermocouple measurement and features automatic cold-junction compensation for each channel to ensure temperature output consistency and stable temperature output in the field. The innovative design of the enhanced model ensures that thermocouple measurement is more accurate than with the earlier design. Besides the thermocouple inputs, the M-7019Z also supports voltage and current input. The voltage input range can be from ± 15 mV to ± 10 V, and the current input range can be set to either $+4 \sim +20$ mA, $0 \sim +20$ mA, or ± 20 mA. Up to 10 different types of Analog Input can be connected to a single module. Overvoltage protection of up to 240 Vrms is provided. The module also features per-channel open wire detection for thermocouple and $+4 \sim +20$ mA input channels.

System Specifications

Model	M-7019Z	
Communication		
Interface	RS-485	
Bias Resistor	No (Usually supplied by the RS-485 Master. Alternatively, add a tM-SG4 or SG-785.)	
Format	(N, 8, 1) (N, 8, 2) (E, 8, 1) (O, 8, 1)	
Baud Rate	1200 to 115200 bps	
Protocol	Modbus RTU, DCON	
Dual Watchdog	Yes, Module (1.6 Seconds), Communication (Programmable)	
LED Indicators/Display		
System LED Indicator	Yes, 1 as Power/Communication Indicator	
I/O LED Indicators	-	
7-segment LED Display	-	
Isolation		
Intra-module Isolation, Field-to-Logic	3000 Vdc	
EMS Protection		
ESD (IEC 61000-4-2)	± 4 kV Contact for each Terminal	
EFT (IEC 61000-4-4)	± 4 kV for Power Line	
Surge (IEC 61000-4-5)	-	
Power		
Reverse Polarity Protection	Yes	
Input Voltage Range	$+10$ Vdc $\sim +30$ Vdc	
Power Consumption	1.8 W	
Mechanical		
Dimensions (L x W x H)	M-7019Z	116 mm x 73 mm x 35 mm
	DB-1820	78 mm x 65 mm x 22 mm
	DN-1822	103 mm x 96 mm x 27 mm
	DN-1823	103 mm x 100 mm x 27 mm
Installation	DIN-Rail or Wall Mounting	
Environment		
Operating Temperature	-25 to $+75^\circ\text{C}$	
Storage Temperature	-40 to $+85^\circ\text{C}$	
Humidity	10 to 95% RH, Non-condensing	

I/O Specifications

Model	M-7019Z	
Analog Input		
Channels	10	
Wiring	Differential	
Sensor Type	Thermocouple	J, K, T, E, R, S, B, N, C, L, M, $L_{DIN43710}$
	Voltage	± 15 mV, ± 50 mV, ± 100 mV, ± 150 mV, ± 500 mV, ± 1 V, ± 2.5 V, ± 5 V, ± 10 V
	Current	± 20 mA, $0 \sim 20$ mA, $4 \sim 20$ mA (Jumper selectable)
Resolution	16-bit	
Accuracy	$\pm 0.1\%$ of FSR	
Sampling Rate	10 Hz (Total)	
Input Impedance	Voltage	2 M Ω
	Current	125 Ω
	Thermocouple	> 400 k Ω
Common Voltage Protection	± 200 Vdc	
Individual Channel Configuration	Yes	
Overvoltage Protection	240 Vrms	
Open Wire Detection (for Thermocouple Input only)	Yes	
Temperature Output Consistency	Yes	
Stable Temperature Output in the Field	Yes	

Thermocouple Types

Type Code	Thermocouple Type	Temperature Range
0E	Type J	-210 to +760°C
0F	Type K	-270 to +1372°C
10	Type T	-270 to +400°C
11	Type E	-270 to +1000°C
12	Type R	0 to +1768°C
13	Type S	0 to +1768°C
14	Type B	0 to +1820°C
15	Type N	-270 to +1300°C
16	Type C	0 to +2320°C
17	Type L	-200 to +800°C
18	Type M	-200 to +100°C
19	Type L _{DIN43710}	-200 to +900°C

Internal I/O Structure

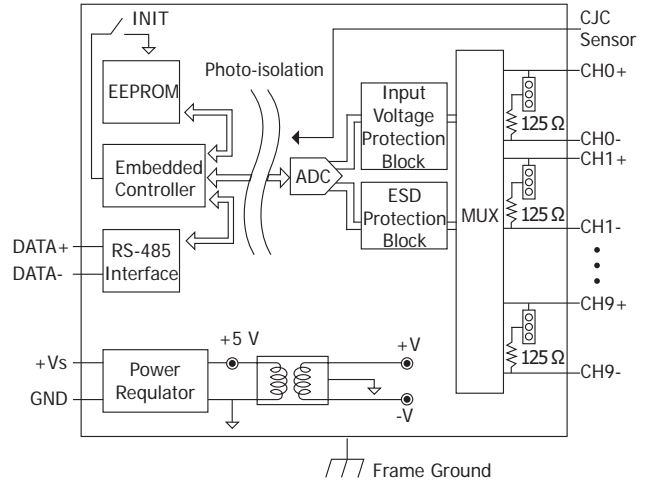

Pin Assignments

M-7019Z

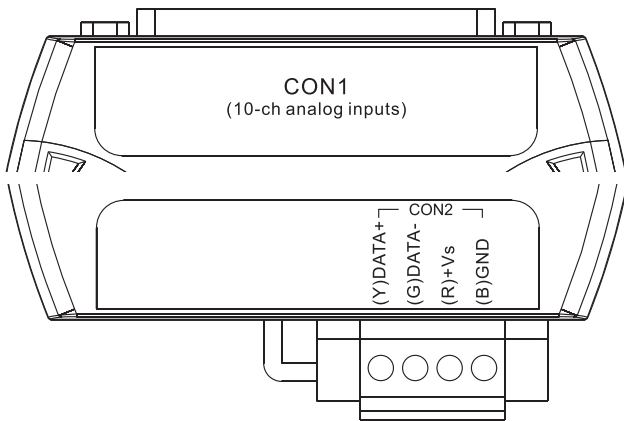

CON1			
Pin Assignment	Terminal	No.	Pin Assignment
+5V	01	14	AGND
CJC	02	15	CH 0+
CH 0-	03	16	CH 1+
CH 1-	04	17	CH 2+
CH 2-	05	18	CH 3+
CH 3-	06	19	CH 4+
CH 4-	07	20	CH 5+
CH 5-	08	21	CH 6+
CH 6-	09	22	CH 7+
CH 7-	10	23	CH 8+
CH 8-	11	24	CH 9+
CH 9-	12	25	N.C.
N.C.	13	Shield	F.G.

25-pin Female D-Sub Connector

DB-1820

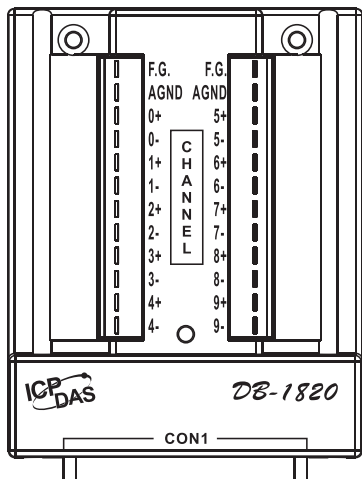

DN-1822

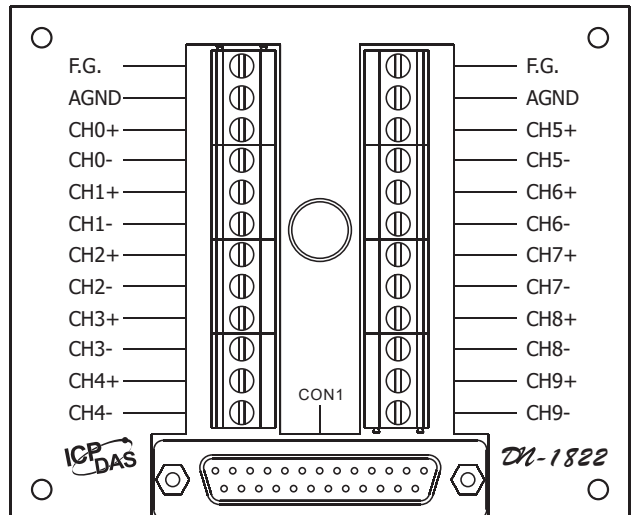

DN-1823

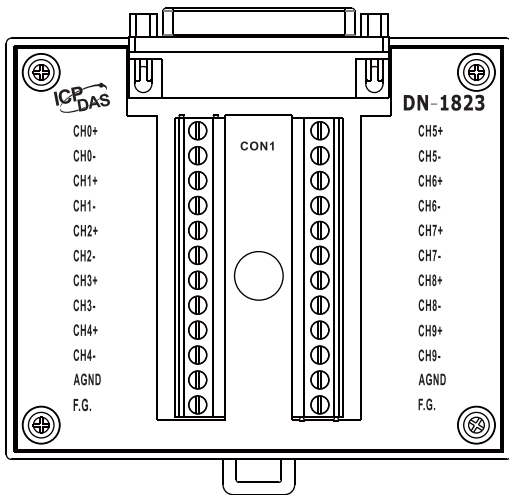

Wire Connections

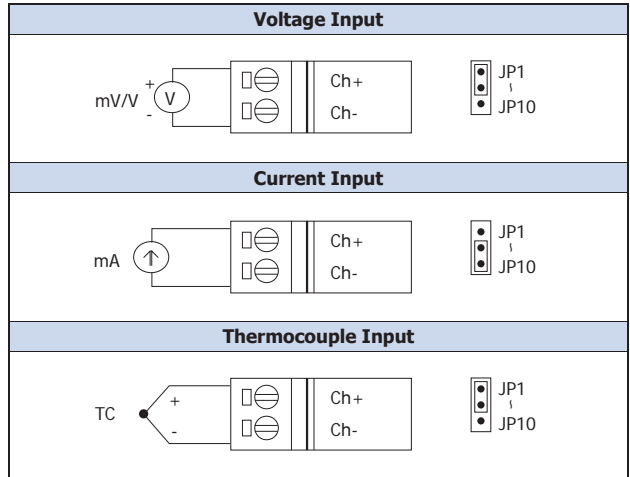

Dimensions (Units: mm)

M-7019Z

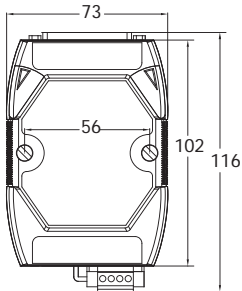

Front View

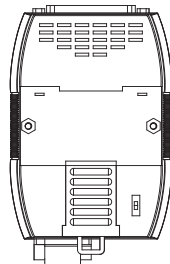

Rear View

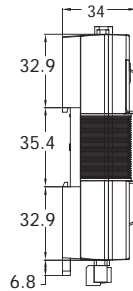

Left Side View

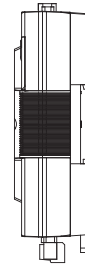

Right Side View

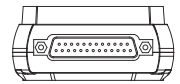

Top View

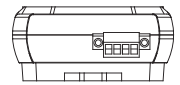

Bottom View

DB-1820

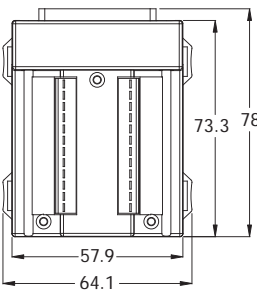

Front View

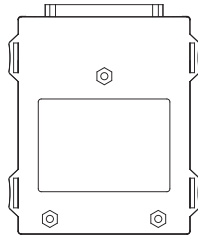

Rear View

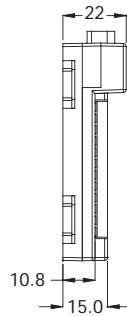

Left Side View

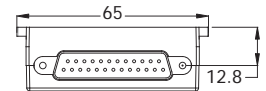

Top View

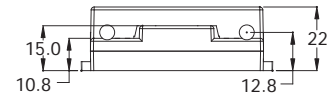

Bottom View

DN-1822

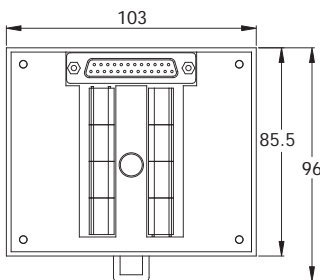

Front View

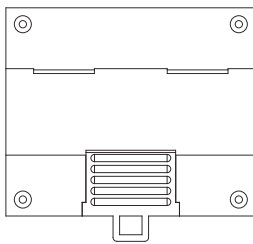

Rear View

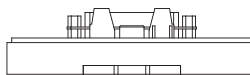

Top View

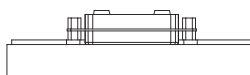

Bottom View



Left Side View

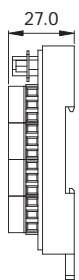



Right Side View

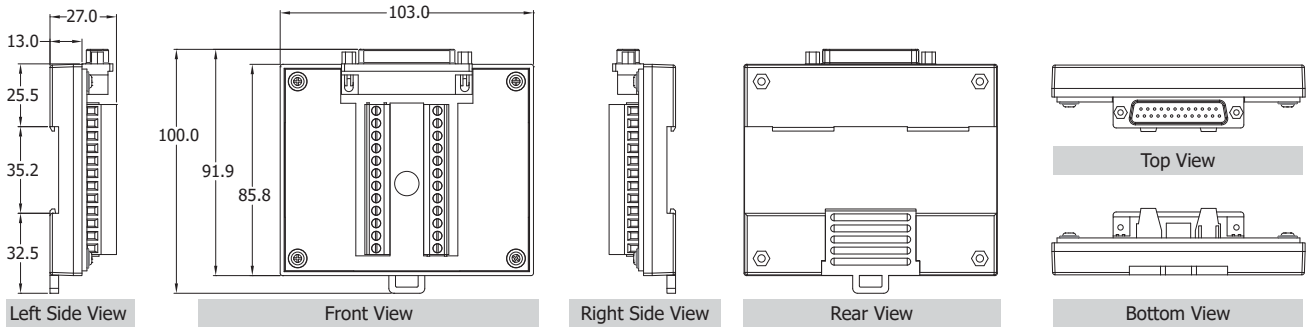



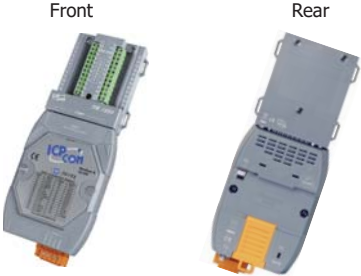

DN-1823









Ordering Information

M-7019Z-G/S CR	10-channel Universal Analog Input Module using the DCON and Modbus Protocols (Gray Cover) (RoHS) Includes an M-7019Z Module and a DB-1820 Daughterboard.	
M-7019Z-G/S2 CR	10-channel Universal Analog Input Module using the DCON and Modbus Protocols (Gray Cover) (RoHS) Includes an M-7019Z Module, a DN-1822 Daughterboard and a CD-2518D 1.8 m Cable.	
M-7019Z-G/S3 CR	10-channel Universal Analog Input Module (Gray Cover) (RoHS), Includes the M-7019Z module, a DN-1823 Daughter Board and a 15 cm Cable	
 <p>M-7019Z-G/S = DB-1820 Connects to the M-7019Z Directly</p>	 <p>M-7019Z-G/S2 = DN-1822 Connects to the M-7019Z Directly</p>	 <p>M-7019Z-G/S3 = DN-1823 Connects to the M-7019Z Directly</p>

Suggested Accessories

 CD-2518D CR	25-pin Female to 25-pin Male 1.8 m Cable for the DB-1820 with DIN-Rail Mount (RoHS)		
 CD-25015 CR	25-pin Female to 25-pin Male 15 cm Cable for the DB-1820 with DIN-Rail Mount (RoHS)		
 4PAPP-006-G CR	Plastic Rack (RoHS)		
 <p>M-7019Z-G/S + CD-25015 + 4PAPP-006-G</p>	 <p>CD-25015 15 cm Cable + DB-1820</p> <p>4PAPP-006-G</p>	 <p>M-7019Z-G/S + CD-2518D</p>	 <p>CD-2518D 1.8 m Cable + DB-1820</p>

Accessories

 tM-7520U CR	RS-232 to RS-485 Converter (RoHS)	 I-7514U CR	4-channel RS-485 Hub (RoHS)
 tM-7561 CR	USB to RS-485 Converter (RoHS)	 SG-770 CR	7-channel Differential or 14-channel Single-ended Surge Protector (RoHS)
 tM-SG4 CR	RS-485 Bias and Termination Resistor Module (RoHS)	 SG-3000 Series	Signal Conditioning Modules for Thermocouple, RTD, DC Voltage, DC Current and Power Input Transformers