



DeviceNet Series Products

1 Port Intelligent DeviceNet Multi-Slave Board



PISO-DNS100U-D

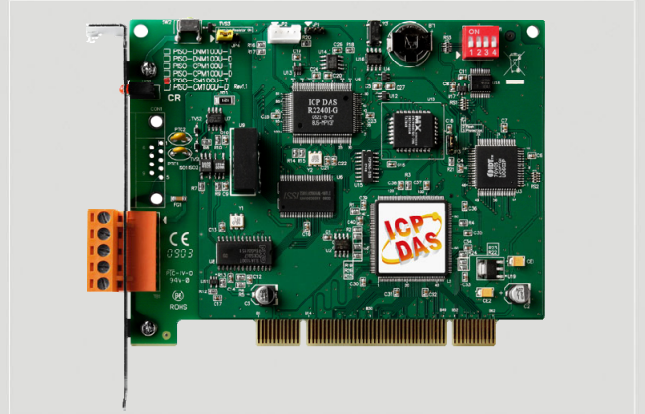

PISO-DNS100U-T

The PISO-DNS100U has completed DeviceNet slave functions according to DeviceNet Group 2 only server. With the built-in 80186, 80M Hz CPU, this card can be applied in high transmission applications. The amazing function is that 10 slave nodes are implemented inside the PISO-DNS100U. It supports up to 512 bytes of input & 512 bytes output data. DeviceNet baud rate is 125 ~ 500 kbps and MACID can be set via utility. The PCI card also has an optically isolated DeviceNet interface.

Features

- DeviceNet Version: Volume I & II, Release 2.0
- Programmable slave MAC ID and baud rate
- Baud Rate: 125k, 250k, 500k bps
- Support Group 2 only Server
- I/O Operating Modes: Poll, Bit-Strobe, Change of State / Cyclic
- I/O Length: max 512 input bytes and 512output bytes per slave
- Slave Node : 10(max) nodes inside the board
- Not Support UCMM
- LED : Status , ERR

Block Diagram

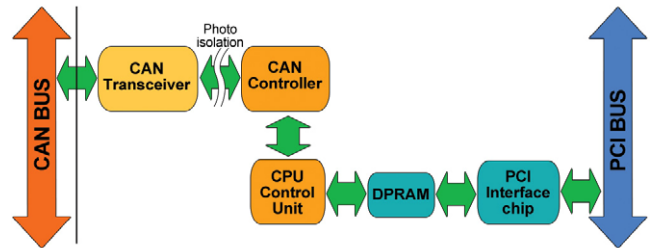

Virtual Slave Concept

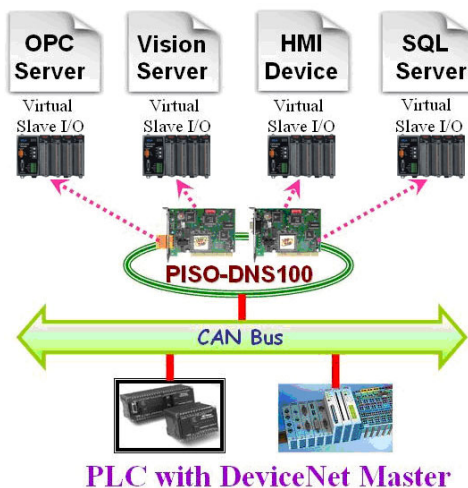

Pin Assignments

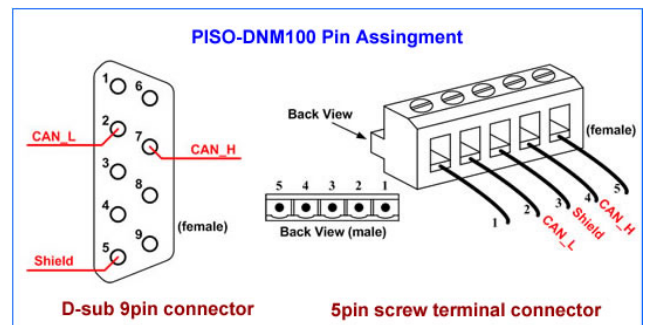

DeviceNet Connection Flowchart

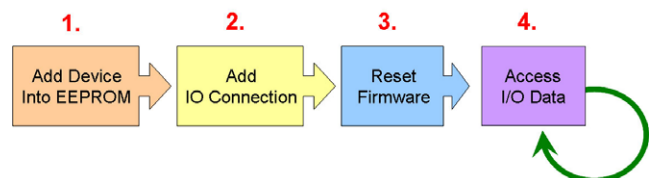

Hardware Specifications

Model Name	PISO-DNS100U-D	PISO-DNS100U-T
Bus Interface		
Type	Universal PCI supports both 5 V and 3.3 V PCI bus	
Board No.	By DIP switch	
CAN Interface		
Controller	NXP SJA1000T with 16 MHz clock Microprocessor inside with 80186 80MHz	
Transceiver	NXP 82C250	
Channel number	1	
Connector	9-pin male D-Sub (CAN_GND, CAN_L, CAN_SHLD, CAN_H, CAN_V+, N/A for others)	5-pin screwed terminal block (CAN_L, CAN_SHLD, CAN_H, N/A for others)
Baud Rate (bps)	125 k, 250 k, 500 k	
Transmission Distance (m)	Depend on baud rate (for example, max. 1000 m at 50 kbps)	
Isolation	3000 V _{DC} for DC-to-DC, 2500 Vrms for photo-couple	
Terminator Resistor	Jumper for 120 Ω terminator resistor	
Specification	ISO-11898-2, CAN 2.0A and CAN 2.0B	
Protocol	DeviceNet Volumn I ver2.0, Volumn II ver2.0	
LED		
Round LED	Status LED, ERR LED	
Software		
Driver	Windows 2K/XP	
Library	VB 6.0, VC++ 6.0, BCB 6.0	
Power		
Power Consumption	300 mA @ 5 V	
Mechanism		
Dimensions	138mm x 22mm x 105mm (W x L x H)	
Environment		
Operating Temp.	0 ~ 60 °C	
Storage Temp.	-20 ~ 70 °C	
Humidity	5 ~ 85% RH, non-condensing	

Application

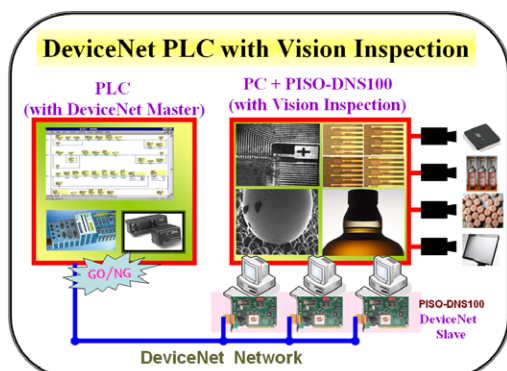

Terminal Resistor

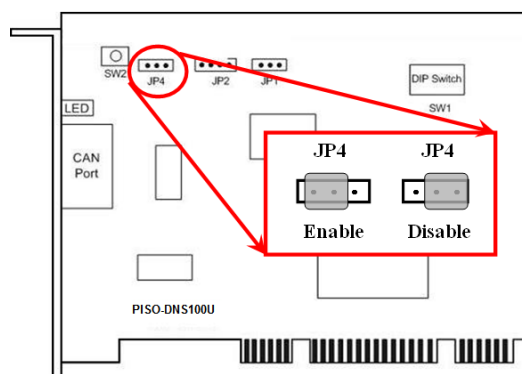

Ordering Information

PISO-DNS100U-D	1 Port Intelligent DeviceNet Multi-Slave Board with 9-pin D-Sub connector
PISO-DNS100U-T	1 Port Intelligent DeviceNet Multi-Slave Board with 5-pin Screw Terminal Connector