

# Quick Start Guide for tM-AD8C

May 2011, Version 1.0.1 beta5

## Congratulations!

Congratulations on purchasing the tM-AD8C - the most popular automation solution for remote monitoring and control applications. This Quick Start Guide will provide information needed to get started with the tM-AD8C. Please also consult the User Manual for detailed information on the setup and use of the tM-AD8C.

## What's in the shipping box?

In addition to this guide, the shipping box includes the following items:

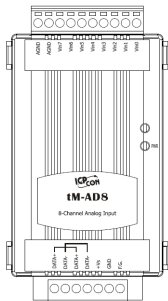

tM-AD8C

## Technical Support

- ICP DAS Website

<http://www.icpdas.com/>

# 1 Understanding the Hardware Specifications and Wiring Diagrams

Before installing the hardware, you should have a basic understanding of hardware specification and the wiring diagrams.

## System Specifications :

### System Specifications

Communication	
Interface	RS-485
Format	(N, 8, 1), (N, 8, 2), (O, 8, 1), (E, 8, 1)
Baud Rate	1200 ~ 115200 bps
Protocol	DCON, Modbus/RTU, Modbus/ASCII
Dual Watchdog	Yes, Module (2.3 seconds), Communication (Programmable)
LED Indicators	
Power	1 LED as Power Indicator
Isolation	
Intra-module Isolation, Field-to-Logic	2500 V <sub>DC</sub>
EMS Protection	
ESD (IEC 61000-4-2)	±4 kV Contact for Each Terminal
	±8 kV Air for Random Point
EFT (IEC 61000-4-4)	±2 kV for Power
Surge (IEC 61000-4-5)	±3 kV for Power
Power Requirements	
Reverse Polarity Protection	Yes
Powered from Terminal Block	Yes, 10 ~ 30 V <sub>DC</sub>
Consumption	0.6 W Max.
Mechanical	
Dimensions (W x L x H)	52 mm x 98 mm x 27 mm
Installation	DIN-Rail Mounting
Environment	
Operating Temperature	-25 ~ +75°C
Storage Temperature	-30 ~ +75°C
Humidity	10 ~ 95% RH, Non-condensing

## I/O Specifications :

### I/O Specifications

Analog Input		
Input Channels		8 Single-ended
Type		0 ~ 20 mA, 4 ~ 20 mA
Resolution	Normal Mode	14-bit
	Fast Mode	12-bit
Sampling Rate	Normal Mode	10 Hz total
	Fast Mode	200 Hz total
Accuracy	Normal Mode	+/-0.1%
	Fast Mode	+/-0.5%
Zero Drift		+/-20 $\mu\text{V}/^\circ\text{C}$
Span Drift		+/-25 ppm/ $^\circ\text{C}$
Input Impedance		125 $\Omega$

## Wire Connection :

### Wire Connections

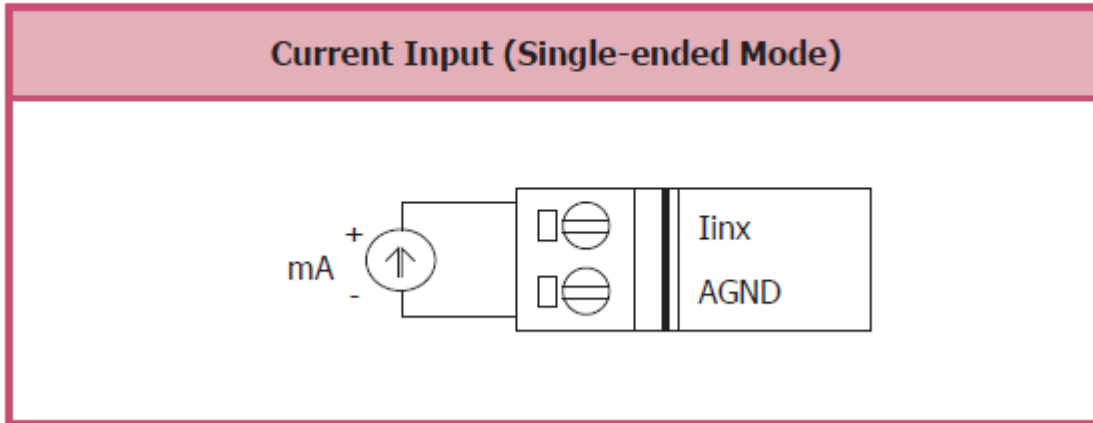

## Pin Assignment :

### Pin Assignments

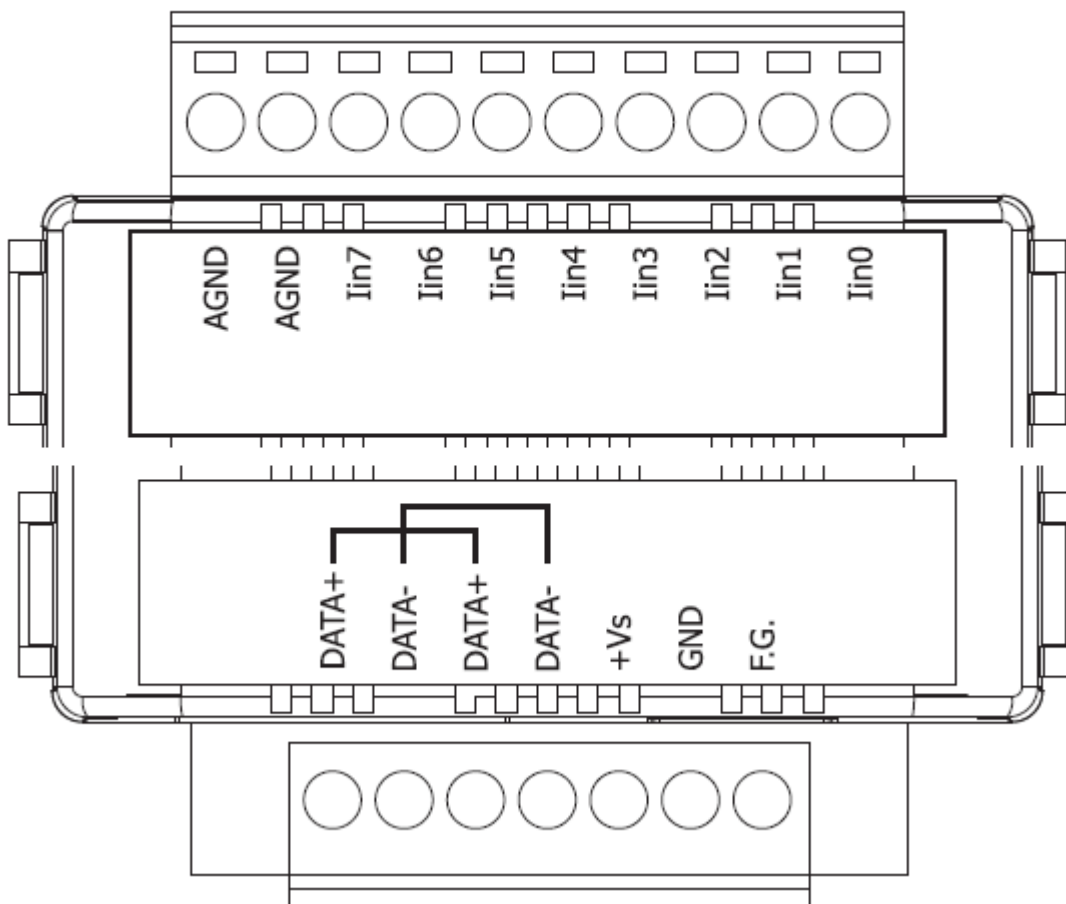



## 2 Booting the tM-AD8C in Init Mode

Make sure the switch placed in the "Init" position.

## 3 Connecting to the PC and the Power Supply

The tM-Series series is equipped with an RS-485 port for connection to a 232/USB converter to PC

Connect to the PC using an RS-485 Converter

Connect to PC using a USB Converter

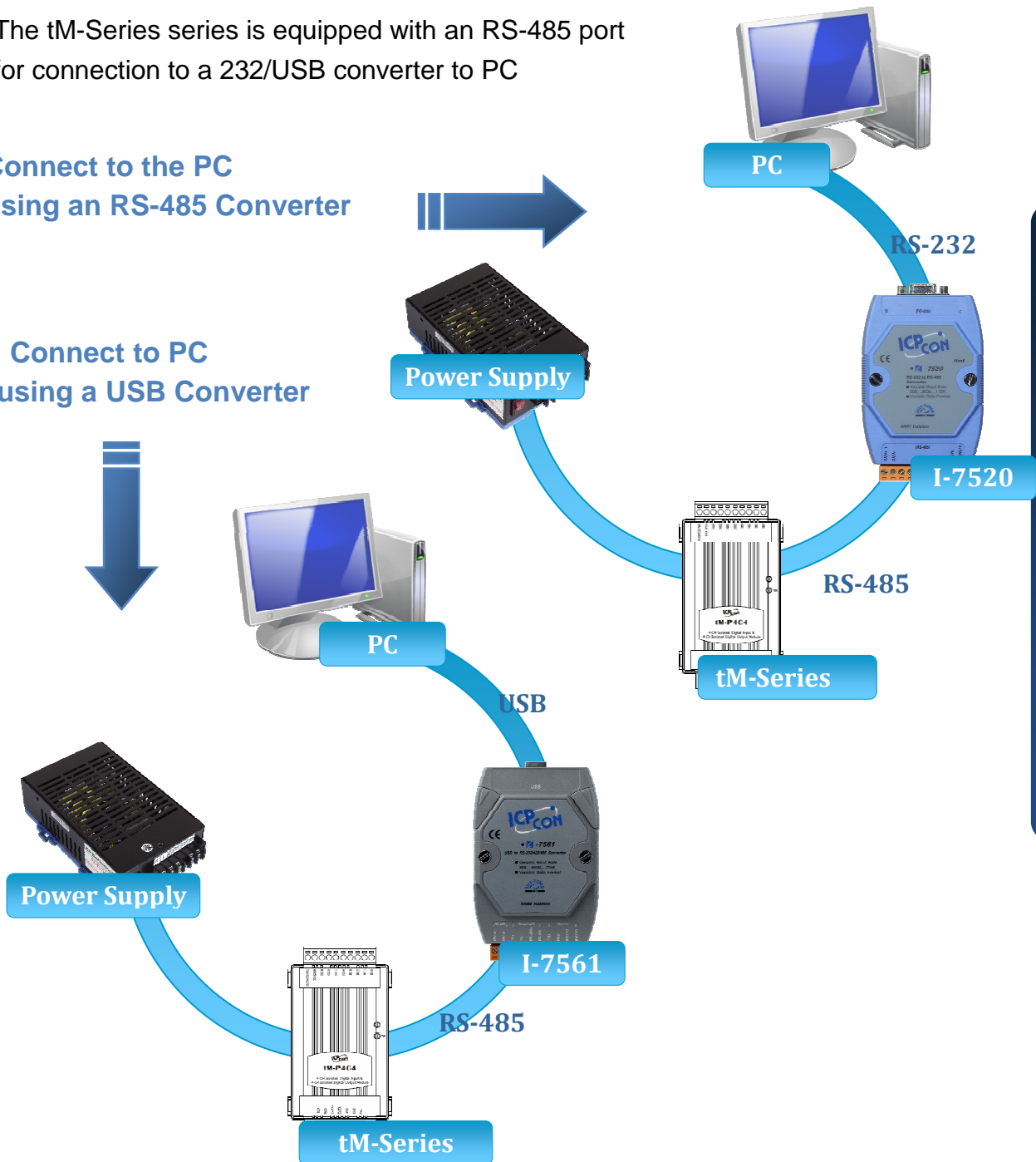

tM-AD8C Quick Start Guide

## 4 Installing the DCON Utility

The DCON Utility is an easy-to-use tool designed to enable simple configuration of I/O modules that use the DCON protocol.

### Step 1: Locate the DCON Utility



The DCON Utility can be obtained from the companion CD or from the ICPDAS FTP site:

DCON\_Utli... CD:\Napdos\8000\NAPDOS\Driver\DCON\_Utility\setup\  
[http://ftp.icpdas.com/pub/cd/8000cd/napdos/driver/dcon\\_utility/](http://ftp.icpdas.com/pub/cd/8000cd/napdos/driver/dcon_utility/)

### Step 2: Follow the prompts to complete the installation



dcon\_utility...

After the installation has been completed, there will be a new shortcut to the DCON Utility on the desktop.

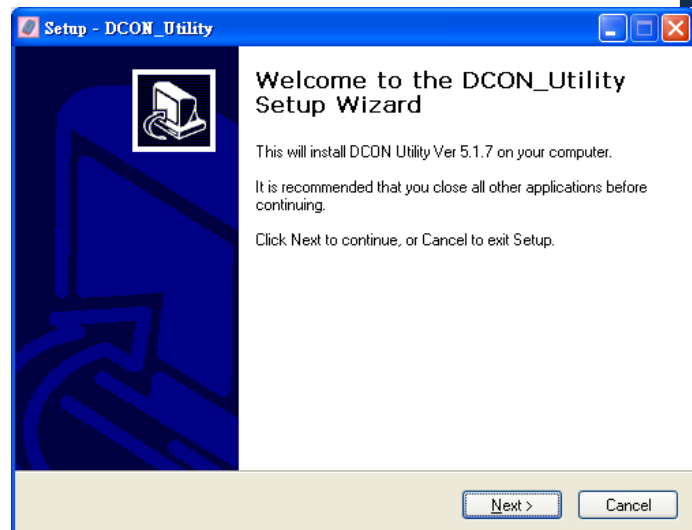

## 5 Using the DCON Utility to Initialize the tM-Series Module

The tM-Series is an I/O module based on the DCON protocol, meaning that you can use the DCON Utility to easily initialize it.

## Step 1: Run the DCON Utility



dcon\_utility...

Double-click the DCON Utility shortcut on your desktop.

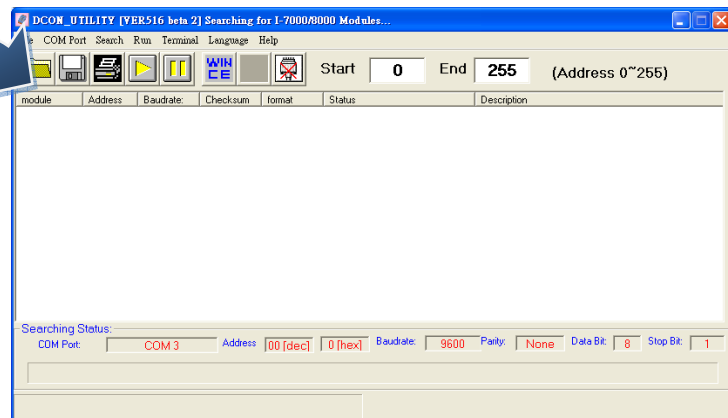

## Step 2: Use the COM1 port to communicate with the tM-Series

Click the "COM Port" option from the menu and a dialog box will be displayed that will allow you to set the communication parameters as described in the table below.

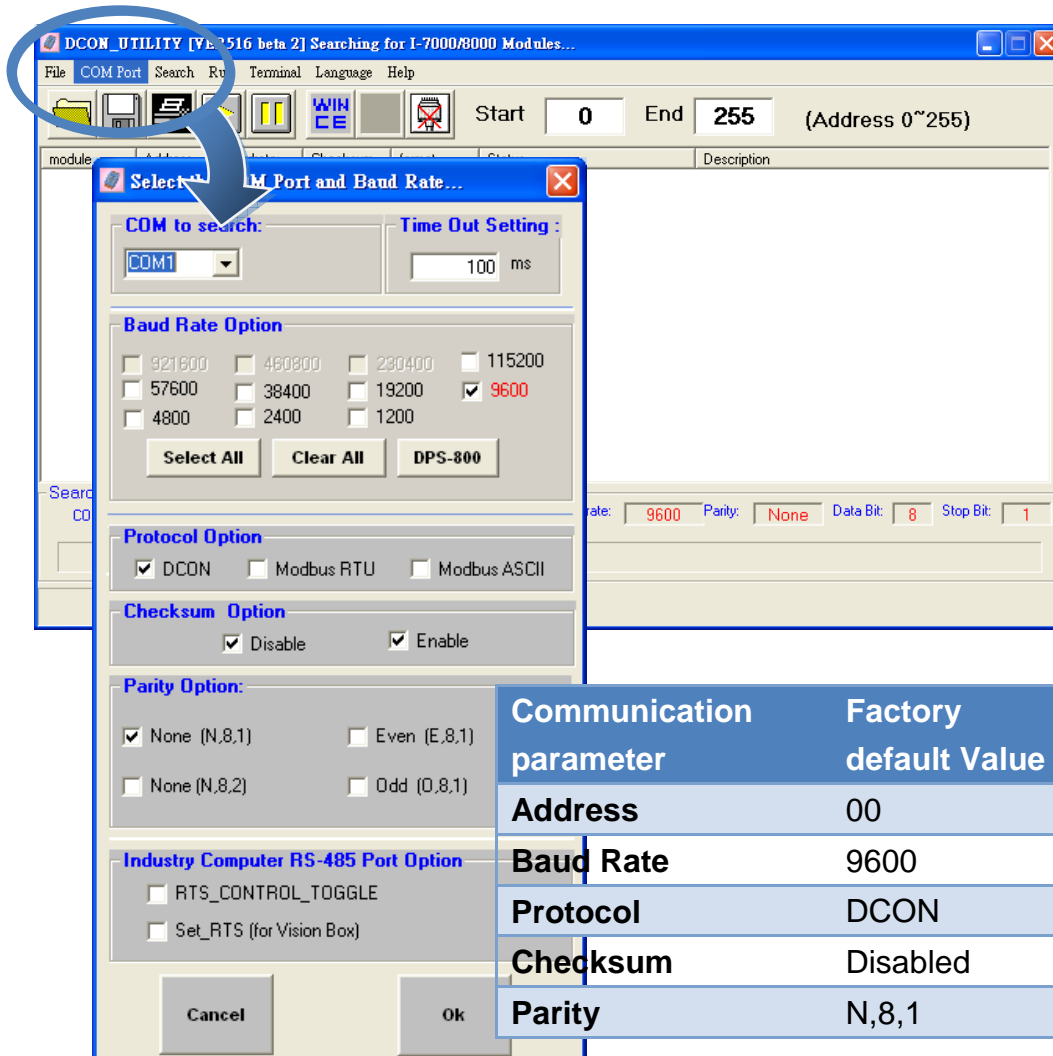

Communication parameter	Factory default Value
Address	00
Baud Rate	9600
Protocol	DCON
Checksum	Disabled
Parity	N,8,1

### Step 3: Search for the tM-Series module

Click “Start Search” button from the toolbox to search for the tM-Series module. After the tM-Series module is displayed in the list, click “Stop Search” button.

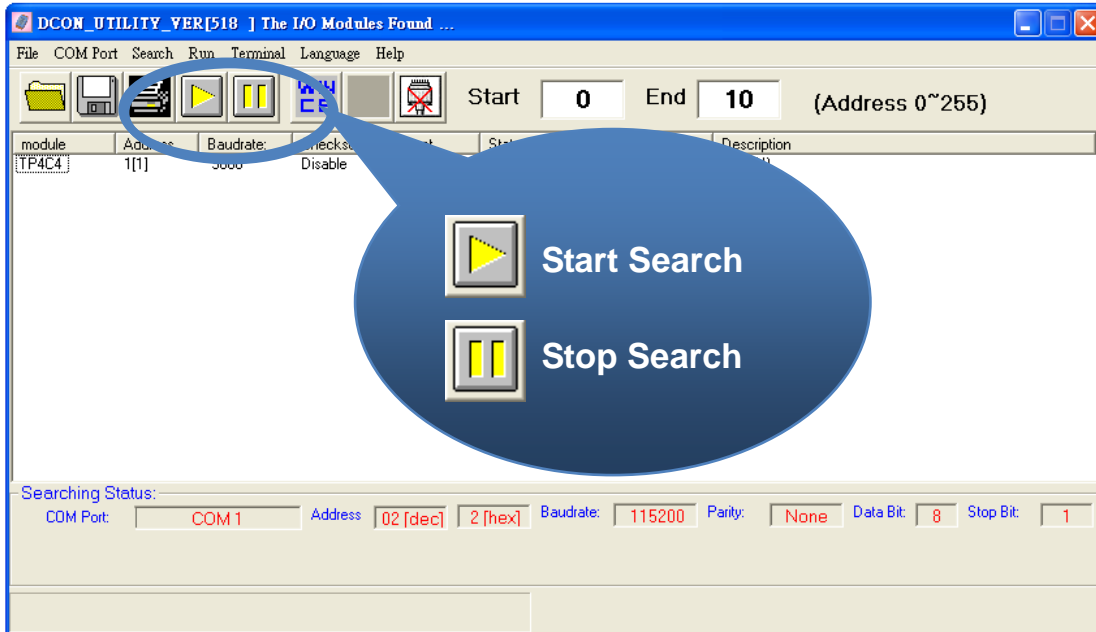

### Step 4: Connect to the tM-Series

After clicking on the name of the module in the list, a dialog box will be displayed.

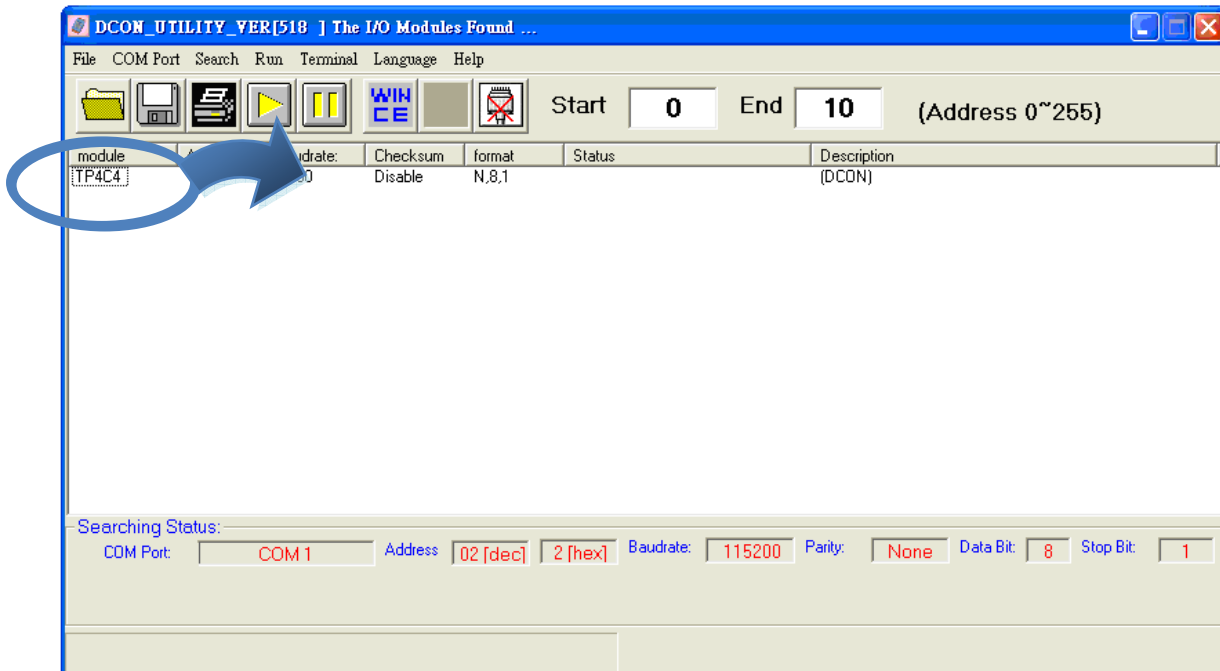



## Step 5: Initialize the tM-Series module

Set the “Address” field in the dialog box to 1 and then click “Setting” button to save the settings.



The Configuration Setting dialog box contains the following fields and controls:

- Protocol: DCON
- Address: 1
- Baudrate: 9600
- Checksum: Disable
- Parity Option: (None Parity (N; 8; 1))
- Setting button



## 6 Rebooting the tM-Series Module in Normal Mode

Make sure the INIT switch is placed in the “Normal” position.

## 7 Starting the Module Operation

After rebooting the tM-Series module, search for the module to make sure the settings have been changed. You can double click on the name of the module in the list to open the configuration dialog box.

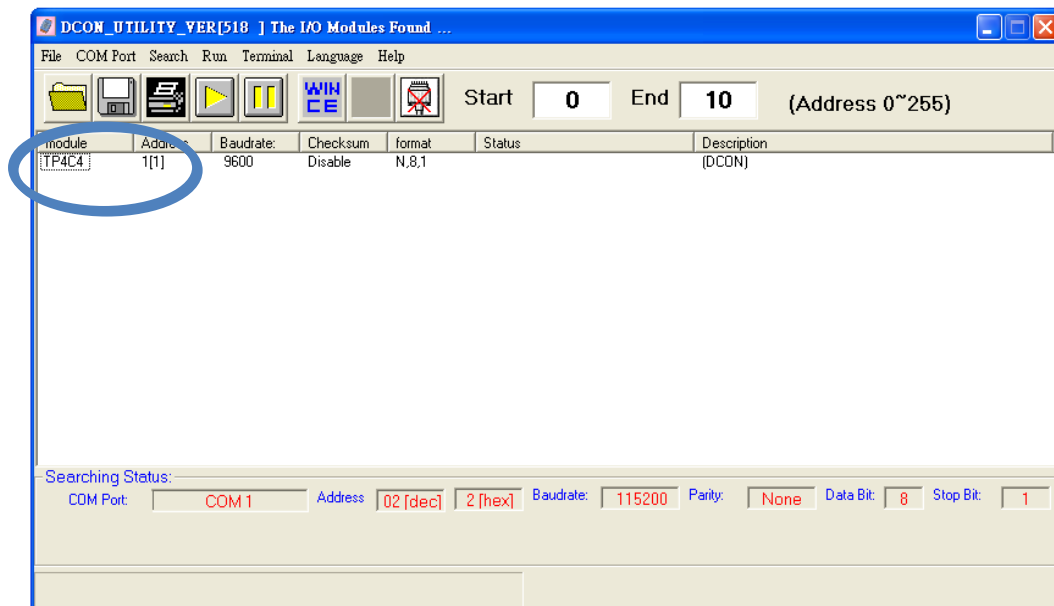

# 8 Modbus Address Mapping

Address	Description	Attribute
30001 ~ 30004	Counter value of digital input	R
40481	Firmware version (low word)	R
40482	Firmware version (high word)	R
40483	Module name (low word)	R
40484	Module name (high word)	R
40485	Module address, valid range: 1 ~ 247	R/W
40486	Bits 5:0 Baud rate, valid range: 3 ~ 10 Bits 7:6 00: no parity, 1 stop bit 01: no parity, 2 stop bit 10: even parity, 1 stop bit 11: odd parity, 1 stop bit	R/W
40488	Modbus response delay time in ms, valid range: 0 ~ 30	R/W
40489	Host watchdog timeout value, 0 ~ 255, in 0.1s	R/W
40492	Host watchdog timeout count, write 0 to clear	R/W
10033 ~ 10036	Digital input value of channel 0 ~ 3	R
10065 ~ 10068	High latched values of DI	R
10073 ~ 10076	High latched values of DO	R
10097 ~ 10100	Low latched values of DI	R
10105 ~ 10108	Low latched values of DO	R
00001 ~ 00004	Digital output value of channel 0 ~ 3	R/W
00129 ~ 00132	Safe value of digital output channel 0 ~ 3	R/W
00161 ~ 00164	Power on value of digital output channel 0 ~ 3	R/W
00193 ~ 00196	Counter update trigger edge of channel 0 ~ 3	R/W
00513 ~ 00518	Write 1 to clear counter value of channel 0 ~ 3	W
00257	Protocol selection, 0: DCON, 1: Modbus	R/W
00258	1: Modbus ASCII, 0: Modbus RTU	R/W
00260	Modbus host watchdog mode 0: same as I-7000 1: can use AO and DO command to clear host watchdog timeout status	R/W

Address	Description	Attribute
00261	1: enable, 0: disable host watchdog	R/W
00264	Write 1 to clear latched DIO	W
00265	DI active state, 0: normal, 1: inverse	R/W
00266	DO active state, 0: normal, 1:inverse	R/W
00270	Host watchdog timeout status, write 1 to clear host watchdog timeout status	R/W
00273	Reset status, 1: first read after powered on, 0: not the first read after powered on	R

Note: For tM DIO modules, Modbus registers starting at 00033 or 10033 can be used to read the digital input values. For M-7000 DIO modules, they are 00033 or 10001.