

3.6. XPAC-8000 & PDS-800 Programmable Device Servers

XP-8000 Programmable Automation Controller

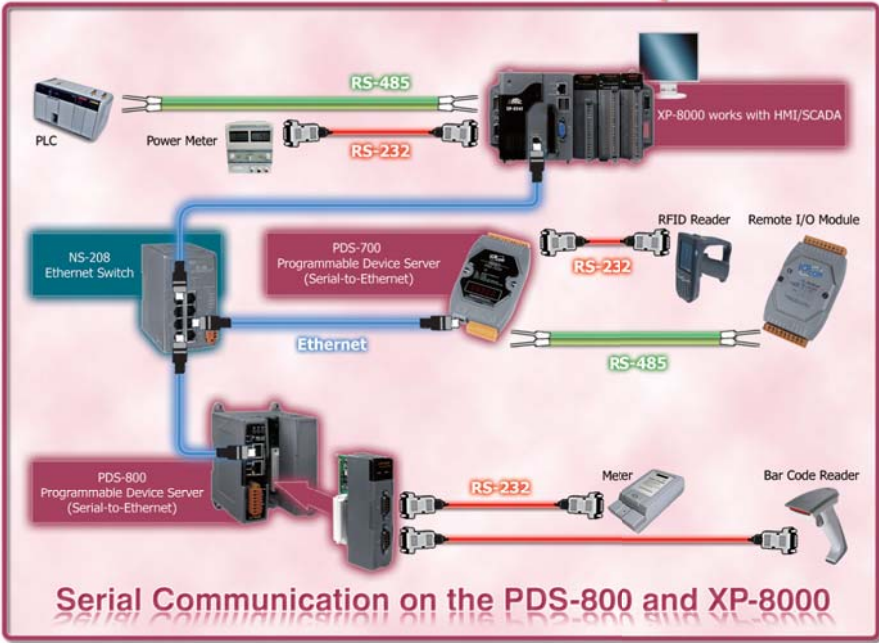

The XP-8000 series is new-generation of PACs from ICP DAS. The XP-8000 is equipped with an AMD LX 800 CPU (500 MHz), uses Windows Embedded Standard 2009 and provides 0, 3 or 7 slots for various high-profile I-8K and I-87K I/O modules. Windows Embedded Standard 2009 is compatible with Windows XP Professional, and therefore, most Win32 desktop programs can directly run on the XP-8000 without software modification.

Users can operate HMI/SCADA software on the XP-8000 using an LCD display, keyboard and a mouse in the same way they usually do on a regular PC. The number of communication ports on the XP-8000/PDS-800 can be expanded by connecting additional serial modules. Users can also install the VxComm Driver on the XP-8000 to create a high amount of virtual COM ports that can be remotely mapped to the serial ports on the PDS-700/PDS-800.

● Selection Guide

Model Name	OS	CPU	Flash	RAM	VGA Resolution	Ethernet	USB	CF Card	RS-232/RS-485	Slots	Page
XP-8041	Windows Embedded Standard 2009	AMD LX 800	4 GB	1 GB	640 x 480 - 1600 x 1200	RJ-45 x 2, 10/100 Base-TX	2	8 GB (supports up to 32 GB)	5	0	3-6-3
XP-8341									4	3	
XP-8741									4	7	

Programmable Device Server with I/O Expansion Slot(s)

3

Programmable Device Servers (Serial-to-Ethernet)

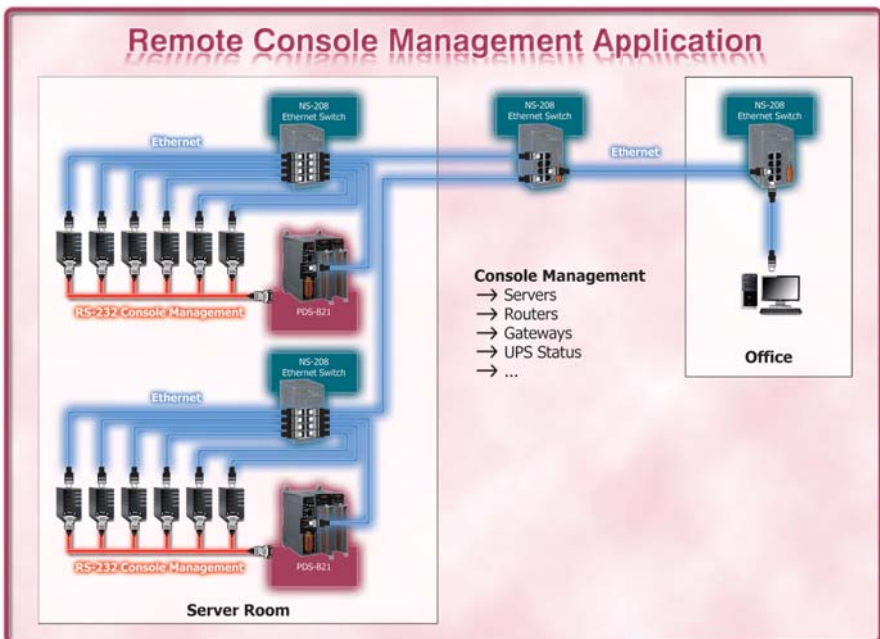

6

XPAC-8000 & PDS-800 Series

Selection Guide

Model Name	Slots	CPU	RAM/ Flash Disk	Ethernet	Operating System	Console Port	(Optional) Max. Serial Ports	Page
PDS-811	1	80186, 80 MHz	512 KB/ 512 KB	2-port Ethernet Switch	MiniOS7	3-wire RS-232	4	3-6-5
PDS-821	2	80186, 80 MHz	512 KB/ 512 KB	2-port Ethernet Switch	MiniOS7	3-wire RS-232	8	3-6-5
PDS-842	4	PXA270, 520 MHz	64 MB/ 64 MB	Dual 10/100 M Ethernet	Linux	DB-9 RS-232	16	3-6-7
PDS-882	8	PXA270, 520 MHz	64 MB/ 64 MB	Dual 10/100 M Ethernet	Linux	DB-9 RS-232	32	3-6-7

Optional Serial Modules

Model Name	Interface	Ports	FIFO	Isolation	Self-Tuner	Connector	Page
I-8112W	9-wire RS-232	2	128 Bytes	2500 V _{rms}	-	DB-9	3-6-9
I-8114W	9-wire RS-232	4	128 Bytes	-	-	DB-37	3-6-11
I-8114IW	5-wire RS-232	4	128 Bytes	2500 V _{rms}	-	DB-37	3-6-11
I-8142W	4-wire RS-422 2-wire RS-485	2	128 Bytes	2500 V _{rms}	Yes	Terminal Block	3-6-13
I-8144IW	4-wire RS-422 2-wire RS-485	4	128 Bytes	2500 V _{rms}	Yes	Terminal Block	3-6-13

NEW



XP-8041/8341/8741

- XP-8041: Standard XP-8000 with 0 I/O Slot
- XP-8341: Standard XP-8000 with 3 I/O Slots
- XP-8741: Standard XP-8000 with 7 I/O Slots

Features

- Windows Embedded Standard 2009
- IIS, ASP.NET, .NET Framework 3.5
- SQL Server 2005 Express Edition
- VS6.0, VS.NET 2003/2005/2008 Supported
- AMD LX 800 CPU (32-bit and 500 MHz)
- 1 GB RAM, 4 GB Built-in Flash, 8 GB CF Card
- One VGA Port, Dual USB Ports
- Dual Ethernet Ports (10/100M)
- 4/5 Serial Ports (RS-232/RS-485)
- Dual Watchdog Timers
- Operating Temperature: -25 °C ~ +75 °C



Introduction

The XP-8x41 Series (XP-8041, XP-8341, XP-8741) is the new generation of PACs from ICP DAS. It is equipped with an AMD LX 800 CPU (500 MHz) running a Windows Embedded Standard 2009 operating system, and provides connectivity for VGA, USB, Ethernet, RS-232/RS-485, and 0, 3 or 7 slots for high performance parallel I/O modules (high profile I-8K series) and serial-type I/O modules (high profile I-8TK I/O modules). The Windows Embedded Standard 2009 operating system has many advantages. Most of all, Windows Embedded Standard 2009 has the same Win32 API as Windows XP Professional, that is, almost every desktop program can be easily ported to Windows Embedded Standard 2009. This effectively reduces the effort required by developers and shortens the time to market.

Applications

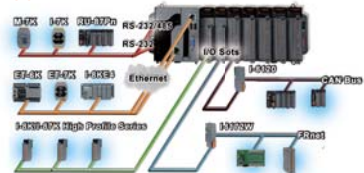

System Specifications

Models	XP-8041	XP-8341	XP-8741
System Software			
OS	Microsoft Windows Embedded Standard 2009 (including SQL Server 2005 Express; Internet Information Service 5.1)		
CPU Module			
CPU	AMD LX 800 processor		
System Memory	1 GB DDR SDRAM		
Dual Battery Backup SRAM	512 KB (for 5 years data retention)		
Flash	4 GB as IDE Master		
EEPROM	16 KB; Data Retention: 40 years; 1,000,000 erase/write cycles		
CF Card	8 GB (support up to 32 GB)		
64-bit Hardware Serial Number	Yes		
Dual Watchdog Timers	Yes		
Rotary Switch	Yes (0 - 9)		
DIP Switch	-	Yes (8 bits)	
VGA & Communication Ports			
VGA	640 x 480 ~ 1600 x 1200		
Ethernet	RJ-45 x 2, 10/100 Base-TX (Auto-negotiating, Auto MDI/MDI-X, LED indicators)		
USB 2.0	2		
COM 1	RS-232 (RxD, TxD and GND); non-isolated	Internal communication with I-8TK modules in slots	
COM 2	RS-232 (RxD, TxD and GND); non-isolated		
COM 3	RS-485	D2+, D2-; internal self-turner ASIC	
	Isolated	3000 V _{DC}	
COM 4	RS-232/RS-485 (RxD, TxD, CTS, RTS and GND for RS-232, Data+ and Data- for RS-485); non-isolated		
COM 5	RS-232 (RxD, TxD, CTS, RTS, DSR, DTR, CD, RT and GND); non-isolated		
I/O Expansion Slots			
Slot	0 slot	3 slots	7 slots
Hot Swap * Will be available	-	For High Profile I-8TK Modules Only	
Mechanical			
Dimensions (W x L x H)	137 mm x 132 mm x 125 mm	231 mm x 132 mm x 125 mm	355 mm x 132 mm x 125 mm
Installation	DIN-Rail or Wall Mounting		
Environmental			
Operating Temperature	-25 °C ~ +75 °C		
Storage Temperature	-30 °C ~ +85 °C		
Ambient Relative Humidity	5% ~ 90% RH, non-condensing		
Power			
Input Range	+10 V _{DC} ~ +30 V _{DC}		
Isolation	1 kV		
Redundant Power Inputs	Yes, with one power relay (1 A @ 24 V _{DC}) for alarm		
Capacity	1.8A, 5V supply to CPU and backplane, total 15 W	1.8A, 5V supply to CPU and backplane, 5.2A, 5V supply to I/O expansion slots, total 35 W	2.0A, 5V supply to CPU and backplane, 5.0A, 5V supply to I/O expansion slots, total 35 W
Consumption	14.4 W (0.6 A @ 24 V _{DC})	14.4 W (0.6 A @ 24 V _{DC})	16.8 W (0.7 A @ 24 V _{DC})

Appearance

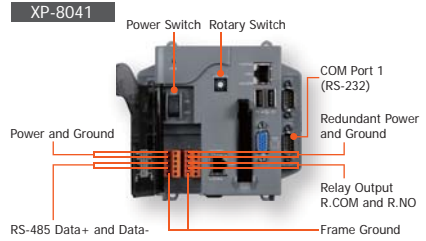
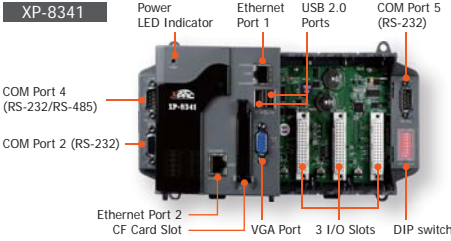

Dimensions (Unit: mm)

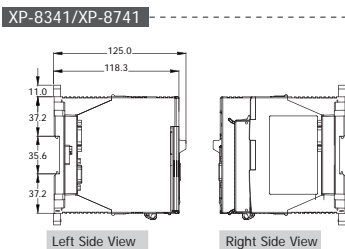
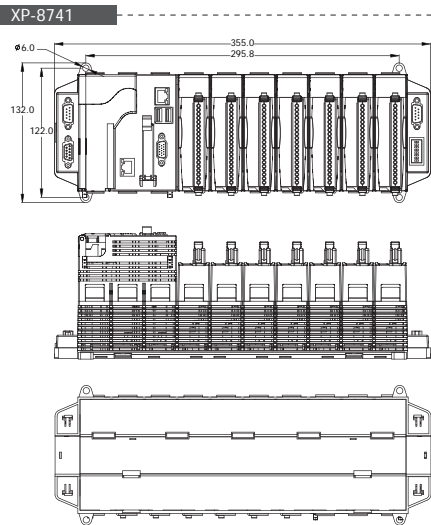
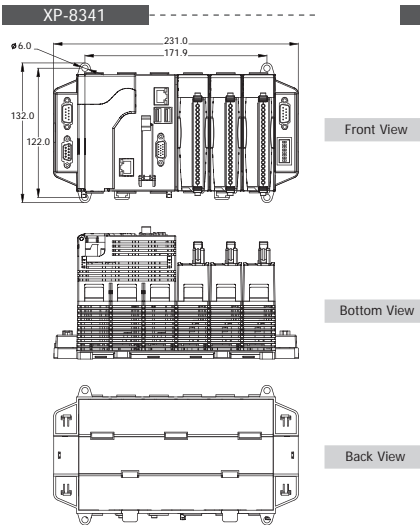
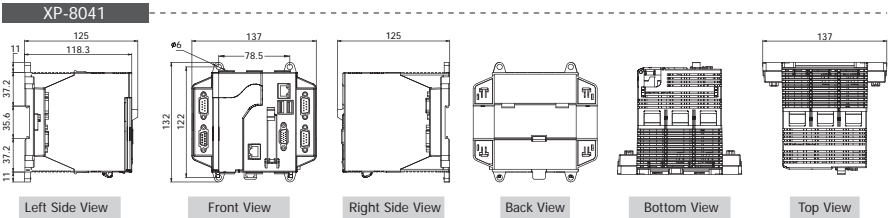

Ordering Information

XP-8041-EN CR	Standard XP-8000 with 0 I/O Slot (English Version of OS) (RoHS)
XP-8341-EN CR	Standard XP-8000 with 3 I/O Slots (English Version of OS) (RoHS)
XP-8741-EN CR	Standard XP-8000 with 7 I/O Slots (English Version of OS) (RoHS)
XP-8041-TC CR	Standard XP-8000 with 0 I/O Slot (Traditional Chinese Version of OS) (RoHS)
XP-8341-TC CR	Standard XP-8000 with 3 I/O Slots (Traditional Chinese Version of OS) (RoHS)
XP-8741-TC CR	Standard XP-8000 with 7 I/O Slots (Traditional Chinese Version of OS) (RoHS)
XP-8041-SC CR	Standard XP-8000 with 0 I/O Slot (Simplified Chinese Version of OS) (RoHS)
XP-8341-SC CR	Standard XP-8000 with 3 I/O Slots (Simplified Chinese Version of OS) (RoHS)
XP-8741-SC CR	Standard XP-8000 with 7 I/O Slots (Simplified Chinese Version of OS) (RoHS)

Accessories

DP-660	24 V _{DC} /2.5 A, 60 W and 5 V _{DC} /0.5 A, 2.5 W Power Supply with DIN-Rail Mounting
DP-1200	24 V _{DC} /5.0 A, 120 W Power Supply with DIN-Rail Mounting
MDR-20-24	24 V _{DC} /1.0 A, 24 W Power Supply with DIN-Rail Mounting
MDR-60-24	24 V _{DC} /2.5 A, 60 W Power Supply with DIN-Rail Mounting

NEW

PDS-811/PDS-821

Programmable Device Server with I/O Expansion Slot(s)

Introduction

The PDS-811 and PDS-821 programmable device servers (PDS) are compact, modular, intelligent, rugged, and are designed for networking RS-232 and RS-422/485 serial devices to an Ethernet network. The PDS-811 has one I/O expansion slot, while PDS-821 has two I/O expansion slots that can be used to attach various 2- or 4-port serial communication modules. Therefore, a maximum of 4 serial ports can be installed on the PDS-811 or a maximum of 8 serial ports can be installed on the PDS-821.

Note: There is no serial module built-in to the PDS-811 or PDS-821 by default.



The PDS-811 and PDS-821 controllers are equipped with a 2-port 10/100 Base-TX Ethernet Switch that can be used to connect two network segments. The Ethernet Switch processes and routes data on the data-link layer (layer 2) of the OSI model to create a different collision domain per switch port. Using a switch allows you to attain dedicated bandwidth on point-to-point connections with every computer, and therefore run in full duplex mode with no collisions. Furthermore, the built-in 2-port Ethernet Switch on the PDS-811/821 enables network wiring to be simplified by cascading your Ethernet devices.

The PDS-8x1 series contains a built-in operating system, the MiniOS7, which offers a stable and high performance environment that is similar to DOS. The MiniOS7 can boot up the PDS-8x1 series within just one second, with the added benefit of no virus problems and a small footprint. Furthermore, the PDS-8x1 series is designed for low power consumption, maintenance elimination (no hard disk and no fan), and is constructed from fire retardant materials (UL94-V0 level) with a robust case.

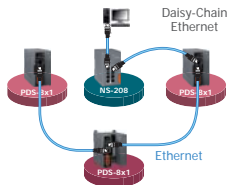

Applications

- Factory Automation
- Building Automation
- Home Automation

Features

- Incorporate Serial Devices in an Ethernet network
- "Virtual COM" extends PC COM ports
- Virtual COM for 32-bit and 64-bit Windows XP/2003/Vista/7
- Programmable Internet/Ethernet Controller
- Watchdog Timer suitable for use in harsh environments
- 2-port 10/100 Base-TX Ethernet Switch (Auto-negotiating, auto MDI/MDI-X, LED indicator)
- Power Reverse Polarity Protection
- 3-wire RS-232 Console Port
- RS-232 Tx/D/RxD LED Indicators
- System Status LED Indicator
- ESD Protection and Frame Ground Design
- RoHS Compliant with no Halogen
- Built-in High Performance MiniOS7 from ICP DAS
- Low power consumption
- Made from fire retardant materials (UL94-V0 Level)



System Specifications

Models	PDS-811	PDS-821
CPU		
CPU	80186, 80 MHz or compatible	
SRAM	512 KB	
Flash Memory	512 KB	
EEPROM	16 KB	
NVRAM	-	
RTC (Real Time Clock)	-	
64-bit Hardware Serial Number	-	
Built-in Watchdog Timer	Yes	
I/O Expansion Slots	1 Slot	2 Slots
Communication Interface		
COM1 (Console)	RS-232 (Tx/D, Rx/D, GND)	
Ethernet	2-port 10/100 Base-TX Ethernet Switch (Auto-negotiating, auto MDI/MDI-X, LED indicator)	
COM Port Formats		
Speed	115200 bps max.	
Data Bit	7, 8	
Parity	None, Even, Odd	
Stop Bit	1	
LED Indicators		
TxD/RxD	Yes (for COM1 console port)	
System	Yes	
Power		
ESD Protection	Yes (with Frame Ground)	
Protection	Power Reverse Polarity Protection	
Required Supply Voltage	+10 V _{cc} ~ +30 V _{cc} (non-regulated)	
Power Consumption	0.6 A @ 5 V for CPU and Backplane, 1.0 A @ 5 V for Plug-in Modules, Total: 8 W	
Mechanical		
Flammability	Fire Retardant Materials (UL94-V0 Level)	
Dimensions (W x L x H, Unit: mm)	64 x 110 x 120	95 x 110 x 132
Installation	DIN-Rail	DIN-Rail or Wall mounting
Environment		
Operating Temperature	-25 °C ~ +75 °C	
Storage Temperature	-40 °C ~ +80 °C	
Humidity	5 ~ 95% RH, non-condensing	

Dimensions (Unit: mm)

PDS-811

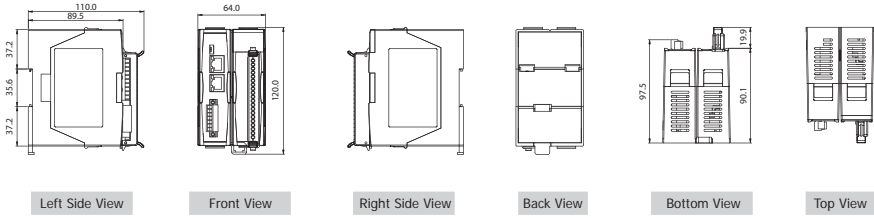

PDS-821

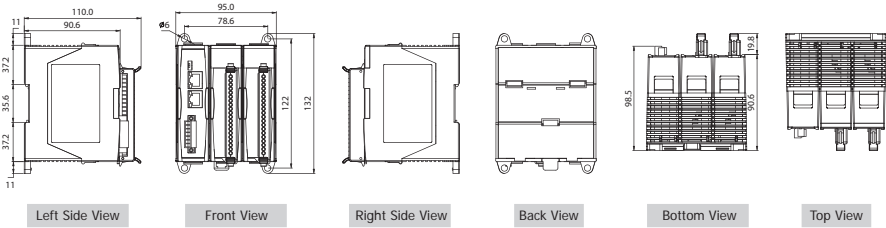

Pin Assignments

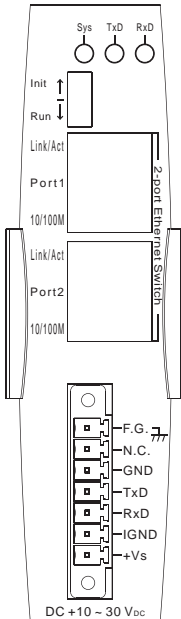

Ordering Information

PDS-811 CR	Programmable Device Server with 1 Expansion Slot (RoHS). Includes One CA-0910 Cable.
PDS-821 CR	Programmable Device Server with 2 Expansion Slots (RoHS). Includes One CA-0910 Cable.

Accessories

CA-0910	9-Pin Female D-Sub & 3-wire RS-232 Cable, 1 m Cable
MDR-20-24	24 V _{oc} /1 A, 24 W Power Supply with DIN-Rail Mounting
NS-205 CR	Unmanaged 5-port Industrial Ethernet Switch (RoHS)

3

Available soon

PDS-842/PDS-882

Programmable Device Server with I/O Expansion Slot(s)

Programmable Device Servers (Serial-to-Ethernet)

Introduction

The PDS-842 and PDS-882 programmable device servers (PDS) are compact, modular, intelligent, rugged, and are designed for networking RS-232/422/485 serial devices to an Ethernet network. The PDS-842 has 4 I/O expansion slots, while the PDS-882 has 8 I/O expansion slots that can be used to attach various 2- or 4-port serial communication modules. Therefore, a maximum of 16 serial ports can be installed on the PDS-842 or a maximum of 32 serial ports can be installed on the PDS-882.



By using the PDS-842 or PDS-882, users can transparently access serial devices over the Internet.

This PDS, coupled with a large built-in RAM buffer, allows for fast transmission and prevents congestion of serial data on the network. A built-in powerful 32-bit RISC processor offers exceptional performance at low power consumption.

The PDS-842 and PDS-882 provides two Ethernet ports, which can be used to implement redundant Ethernet communication and separate Ethernet communication (one for global Internet, one for private Ethernet). To prevent the PDS-842 and PDS-882 from failing due to power loss, the power module is designed with two inputs, so that the module can continue working even if one power input fails, and, meanwhile, there is a relay output available for informing users about the power failure.

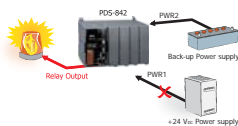

Applications

- Factory Automation
- Building Automation
- Home Automation

6

XPAC-8000 & PDS-800 Series

PDS-842/PDS-882

Features

- Linux kernel 2.6.19 Inside
- Standard PDS-8x2 SDK for Windows and Linux operating systems
- Incorporate Serial Devices in an Ethernet network
- "Virtual COM" extends PC COM ports
- Virtual COM for 32-bit and 64-bit Windows XP/2003/Vista/7
- Programmable Internet/Ethernet Controller
- Watchdog Timer suitable for use in harsh environments
- Dual-LAN, 10/100 Base-TX Ethernet (Auto-negotiating, auto MDI/MDI-X, LED Indicator)
- Power Reverse Polarity Protection
- DB-9 RS-232 console port
- ESD Protection and Frame Ground Design
- Low power consumption
- Made from fire retardant materials (UL94-V0 Level)
- Supported Protocol: CAN bus Network, Industrial Modbus TCP/RTU, SNMP



System Specifications

Models	PDS-842	PDS-882
CPU	PXA270 or compatible (32-bit and 520 MHz)	
SDRAM	64 MB	
Flash Memory	64 MB	
EEPROM	16 KB	
NVRAM	-	
RTC (Real Time Clock)	No	
64-bit Hardware Serial Number	Yes	
Built-in Watchdog Timer	Yes	
I/O Expansion Slots	4 Slots	8 Slots
Programmable LED Indicator	1	
Communication Interface		
COM1 (Console)	RS-232	
COM2	RS-485 (D+, D-): 3000 V _{dc} Isolated	
Ethernet	RJ-45 x 2, Dual 10/100 Base-TX Ethernet Controller (Auto-negotiating, auto MDI/MDI-X, LED indicator)	
COM Port Formats		
Speed	115200 bps max.	
Data Bit	7, 8	
Parity	None, Even, Odd	
Stop Bit	1	
Power		
ESD Protection	Yes (with Frame Ground)	
Protection	Power Reverse Polarity Protection	
Redundant Power Inputs	Yes, with one relay for warning alarm	
Required Supply Voltage	+18 V _{dc} ~ +48 V _{dc}	
Power Consumption	8.4 W (0.35 A @ 24 V _{dc})	9.1 W (0.38 A @ 24 V _{dc})
Mechanical		
Flammability	Fire Retardant Materials (UL94-V0 Level)	
Dimensions (W x L x H, Unit: mm)	188 x 132 x 111	312 x 132 x 111
Installation	DIN-Rail or Wall mounting	
Environment		
Operating Temperature	-25 °C ~ +75 °C	
Storage Temperature	-30 °C ~ +85 °C	
Humidity	5 ~ 90% RH, non-condensing	

Dimensions (Unit: mm)

PDS-842

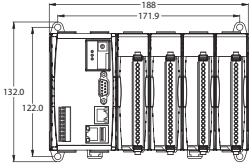

Front View

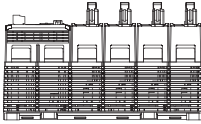

Bottom View

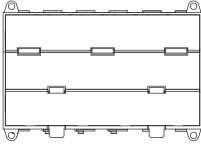

Back View

PDS-882

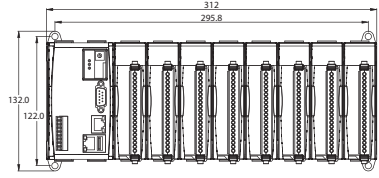

Front View

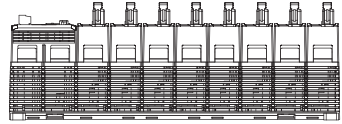

Bottom View

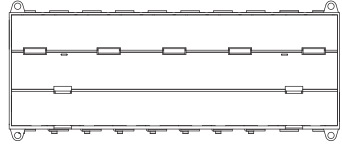

Back View

Pin Assignments

COM1: RS-232

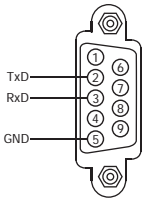

Terminal Block

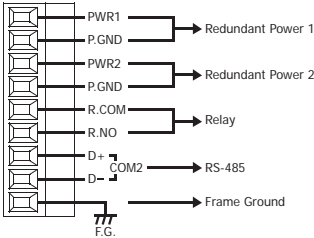

PDS-842/882

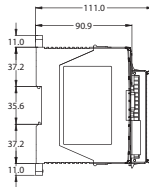

Left Side View

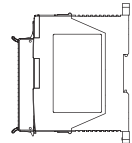

Right Side View

Ordering Information

PDS-842	Programmable Device Server with 4 Expansion Slots
PDS-882	Programmable Device Server with 8 Expansion Slots

Accessories

KA-52F	24 Vdc/1.04 A, 25 W Power Supply
DIN-KA52F	24 Vdc/1.04 A, 25 W Power Supply with Din-Rail Mounting
MDR-60-24	24 Vdc/2.5 A, 60 W Power Supply with DIN-Rail Mounting
CA-0915	9-Pin Male-Female D-Sub Cable, 1.5 m Cable
NS-205 CR	Unmanaged 5-port Industrial Ethernet Switch (RoHS)



Introduction

The I-8112iW-G provides 2 isolated RS-232 serial ports. It is equipped with a 128-byte hardware FIFO for each port and offers speeds up to 115.2 kbps with support for full-duplex communication.

In harsh industrial environments, the onboard ESD protection devices attempt to divert any potentially damaging charges away from sensitive circuitry and protect the I-8112iW-G from permanent damage.

The serial communication modules are designed for use with intelligent devices like bar code readers, serial printers, intelligent sensors, instrumentation equipment, computers, and almost any device with an RS-232 or RS-422/485 port.

I/O Specifications

RS-232 Interface	
Number of Ports	2
Interface	TxD, RxD, RTS, CTS, DSR, DTR, DCD, RI, GND
Controller	16C950 Compatible
	Speed: 115200 bps max.
	Data Bit: 5, 6, 7, 8
	Stop Bit: 1, 1.5, 2
	Parity: None, Even, Odd, Mark, Space
FIFO: Internal 128 bytes for each port	
Interrupt	Shared Interrupt
Bus	Parallel I/O Module
Connector	DB-9 (Male)
Intra-module Isolated, Field to Logic	2500 V _{ms}
ESD Protection	+/-4 kV (Contact for each channel)

Software

Software
Supports interrupt driven software library
Supports VxCOM library

RS-232 Interface

Features

- High-profile Module
- 2500 V_{ms} Isolation
- Serial Port with +/-4 kV ESD Protection
- Internal 128-byte Hardware FIFO for each Port
- Baud Rate of up to 115200 bps
- LED Indicators for Tx/D, Rx/D and Power Status
- RoHS Compliant with no Halogen
- Low power consumption
- Made from fire retardant materials (UL94-V0 Level)



Applications

- Factory Automation
- Building Automation
- Home Automation

System Specifications

LED Indicators	
Power	1 LED
TxD	2 LEDs
RxD	2 LEDs
Power	
Power Consumption	1.5 W
Mechanical	
Dimensions (W x L x H)	31 mm x 86 mm x 114 mm
Environment	
Operating Temperature	-25 °C ~ +75 °C
Storage Temperature	-40 °C ~ +85 °C
Humidity	5 ~ 95% RH, non-condensing

Wiring

DTE Device (Computer)		DB-9	DTE to DCE Connections		DCE Device (Modem)		DB-9
Pin#	DB-9	RS-232 Signal Names	Signal Direction		Pin#	DB-9	RS-232 Signal Names
#1	Carrier Detector	DCD	←		#1	Carrier Detector	DCD
#2	Receive Data	RxD	←		#2	Transmit Data	TxD
#3	Transmit Data	TxD		→	#3	Receive Data	RxD
#4	Data Terminal Ready	DTR	←		#4	Data Set Ready	DSR
#5	Signal Ground/Common (SG)	GND	←		#5	Signal Ground/Common (SG)	GND
#6	Data Set Ready	DSR		→	#6	Data Terminal Ready	DTR
#7	Request to Send	RTS	←		#7	Clear to Send	CTS
#8	Clear to Send	CTS		→	#8	Request to Send	RTS
#9	Ring Indicator	RI	←		#9	Ring Indicator	RI
Soldered to DB-9 Metal Shield		FGND	←		Soldered to DB-9 Metal Shield		FGND

3-wire RS-232 Wiring

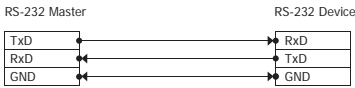

Pin Assignments

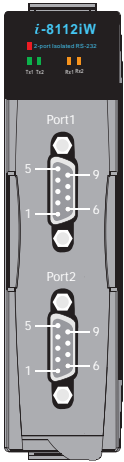

Pin Assignment	Terminal	No.	Pin Assignment
GND1	05	09	RI1
DTR1	04	08	CTS1
TxD1	03	07	RTS1
RxD1	02	06	DSR1
DCD1	01		

Port1 9-Pin Male D-Sub Connector

Pin Assignment	Terminal	No.	Pin Assignment
GND2	05	09	RI1
DTR2	04	08	CTS2
TxD2	03	07	RTS2
RxD2	02	06	DSR2
DCD2	01		

Port2 9-Pin Male D-Sub Connector

Dimensions (Unit: mm)

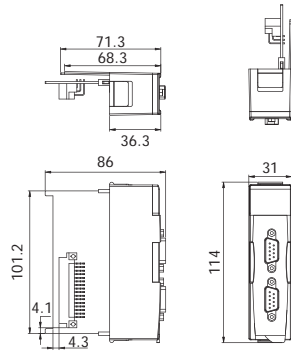

Ordering Information

I-8112IW-G-CR	2-port Isolated RS-232 Module (RoHS)
---------------	--------------------------------------

Accessories

CA-0915	9-Pin Male-Female D-Sub Cable, 1.5 m
---------	--------------------------------------



Introduction

The I-8114W-G provides 4 non-isolated RS-232 serial ports, while the I-8114iW-G provides 4 isolated RS-232 serial ports. It is equipped with a 128-byte hardware FIFO for each port and offers speeds up to 115.2 kbps with support for full-duplex communication.

In harsh industrial environments, the onboard ESD protection devices attempt to divert any potentially damaging charges away from sensitive circuitry and protect the I-8114W-G/I-8114iW-G from permanent damage.

The serial communication modules are designed for use with intelligent devices like bar code readers, serial printers, intelligent sensors, instrumentation equipment, computers, and almost any device with an RS-232 or RS-422/485 port.

I/O Specifications

Models	I-8114W	I-8114iW
RS-232 Interface		
Number of Ports	4	
Interface	TxD, RxD, RTS, CTS, DSR, DTR, DCD, RI, GND	TxD, RxD, RTS, CTS, GND
Controller	16C950 Compatible	
	Speed: 115200 bps max.	
	Data Bit: 5, 6, 7, 8	
	Stop Bit: 1, 1.5, 2	
	Parity: None, Even, Odd, Mark, Space	
Interrupt	FIFO: Internal 128 bytes for each port	
Shared Interrupt		
Bus	Parallel I/O Module	
Connector	DB-37 (Female)	
Intra-module Isolated, Field to Logic	-	2500 V _{rms}
ESD Protection	+/-4 kV (Contact for each channel)	

Software

Software
Supports interrupt driven software library
Supports VxCOM library

RS-232 Interface

Features

- High-profile Module
- 2500 V_{rms} Isolation for I-8114iW
- Serial Port with +/-4 kV ESD Protection
- Internal 128-byte Hardware FIFO for each Port
- Baud Rate of up to 115200 bps
- LED Indicators for Tx/D and Power Status
- RoHS Compliant with no Halogen
- Low power consumption
- Made from fire retardant materials (UL94-V0 Level)



Applications

- Factory Automation
- Building Automation
- Home Automation

System Specifications

Models	I-8114W	I-8114iW
LED Indicators		
Power	1 LED	
TxD	4 LEDs	
RxD	4 LEDs	
Power		
Power Consumption	1.25 W	1.75 W
Mechanical		
Dimensions (W x L x H)	31 mm x 85 mm x 114 mm	
Environment		
Operating Temperature	-25 °C ~ +75 °C	
Storage Temperature	-40 °C ~ +85 °C	
Humidity	5 ~ 95% RH, non-condensing	

Wiring

DTE Device (Computer)		DB-9	DTE to DCE Connections		DCE Device (Modem)		DB-9
Pin#	DB-9	RS-232 Signal Names	Signal Direction		Pin#	DB-9	RS-232 Signal Names
#1	Carrier Detector	DCD	←		#1	Carrier Detector	DCD
#2	Receive Data	RxD	←		#2	Transmit Data	TxD
#3	Transmit Data	TxD		→	#3	Receive Data	RxD
#4	Data Terminal Ready	DTR	←		#4	Data Set Ready	DSR
#5	Signal Ground/Common (SG)	GND	←		#5	Signal Ground/Common (SG)	GND
#6	Data Set Ready	DSR		→	#6	Data Terminal Ready	DTR
#7	Request to Send	RTS	←		#7	Clear to Send	CTS
#8	Clear to Send	CTS		→	#8	Request to Send	RTS
#9	Ring Indicator	RI	←		#9	Ring Indicator	RI
Soldered to DB-9 Metal Shield		FGND	←		Soldered to DB-9 Metal Shield		FGND

3-wire RS-232 Wiring

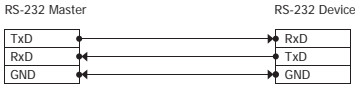

Pin Assignments

Pin Assignment	Terminal	No.	Pin Assignment
N.C.	01	20	RI3
DCD3	02	21	DTR3
GND	03	22	DSR3
CTS3	04	23	RTS3
RxD3	05	24	TxD3
RI4	06	25	DCD4
DTR4	07	26	GND
DSR4	08	27	CTS4
RTS4	09	28	RxD4
TxD4	10	29	RI2
DCD2	11	30	DTR2
GND	12	31	DSR2
CTS2	13	32	RTS2
RxD2	14	33	TxD2
RI1	15	34	DCD1
DTR1	16	35	GND
DSR1	17	36	CTS1
RTS1	18	37	RxD1
TxD1	19		

37-Pin Female D-Sub Connector

Pin Assignment	Terminal	No.	Pin Assignment
N.C.	01	20	N.C.
N.C.	02	21	N.C.
GND3	03	22	N.C.
CTS3	04	23	RTS3
RxD3	05	24	TxD3
N.C.	06	25	N.C.
N.C.	07	26	GND4
RTS4	09	27	CTS4
TxD4	10	29	N.C.
N.C.	11	30	N.C.
GND2	12	31	N.C.
CTS2	13	32	RTS2
RxD2	14	33	TxD2
N.C.	15	34	N.C.
N.C.	16	35	GND1
N.C.	17	36	CTS1
RTS1	18	37	RxD1
TxD1	19		

37-Pin Female D-Sub Connector

Dimensions (Unit: mm)

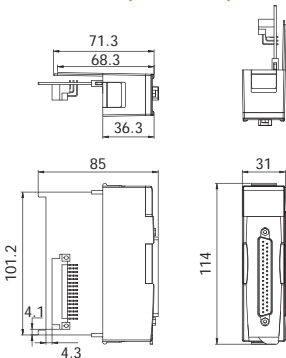

Ordering Information

I-8114W-G CR	4-port RS-232 Module (RoHS)
I-8114W-G/D2 CR	4-port RS-232 Module (RoHS) Includes One CA-9-3705 Cable
I-8114IW-G CR	4-port Isolated RS-232 Module (RoHS)
I-8114IW-G/D2 CR	4-port Isolated RS-232 Module (RoHS) Includes One CA-9-3705 Cable

Accessories

CA-4002	37-Pin Male D-Sub Connector with Plastic Cover.
CA-9-3705	DB-37 Male (D-Sub) to 4-port DB-9 Male (D-Sub) Cable 0.5 m Cable for I-8114W-G/I-8114IW-G (90°)



Introduction

The I-8142iW-G provides 2 isolated RS-422/485 serial ports, while the I-8144iW-G provides 4 isolated RS-422/485 serial ports. It is equipped with a 128-byte hardware FIFO for each port and offers speeds up to 115.2 kbps with support for RS-422 full-duplex communication.

In harsh industrial environments, the onboard ESD protection devices attempt to divert any potentially damaging charges away from sensitive circuitry and protect the I-8142iW-G/I-8144iW-G from permanent damage.

The serial communication modules are designed for use with intelligent devices like bar code readers, serial printers, intelligent sensors, instrumentation equipment, computers, and almost any device with an RS-232 or RS-422/485 port.

I/O Specifications

Models	I-8142iW	I-8144iW
RS-422/485 Interface		
Number of Ports	2	4
Interface	Isolated RS-422/485 (The RS-422 and RS-485 can not be used simultaneously) RS-422: TxD+, TxD-, RxD+, RxD-, GND RS-485: D+, D-, GND	
2-wire Cabling/ 4-wire Cabling	Belden 8941 (2P twisted-pair cable)/ Belden 8942 (4P twisted-pair cable), If different cables are used, the transmission distance may change	
Transfer Distance	Max. of 1,200 m at 9.6 kbps; Max. of 400 m at 115.2 kbps	
4-wire Cabling	Max. of 256 devices. in a single RS-485 network without using a repeater	
Controller	16C950 Compatible Speed: 115200 bps max. Data Bit: 5, 6, 7, 8 Stop Bit: 1, 1.5, 2 Parity: None, Even, Odd, Mark, Space FIFO: Internal 128 bytes for each port	
Self-Tuner Asic inside	Yes	
Interrupt	Shared Interrupt	
Bus	Parallel I/O Module	
Connector	Removable 20-Pin Terminal Block	
Intra-module Isolated, Field to Logic	2500 V _{rms}	
ESD Protection	+/-4 kV (Contact for each channel)	

RS-422/485 Interface

Features

- High-profile Module
- 2500 V_{rms} Isolation
- Serial Port with +/-4 kV ESD Protection
- Internal 128-byte Hardware FIFO for each Port
- Baud Rate of up to 115200 bps
- LED Indicators for TxD, RxD and Power Status
- Built-in Self-Tuner or Auto-Direction Control
- RoHS Compliant with no Halogen
- Low power consumption
- Made from fire retardant materials (UL94-V0 Level)



Applications

- Factory Automation
- Building Automation
- Home Automation

System Specifications

Models	I-8142iW	I-8144iW
LED Indicators		
Power	1 LED	
TxD	2 LEDs	4 LEDs
RxD	2 LEDs	4 LEDs
Power		
Power Consumption	1.5 W (Without Resistor)	1.75 W (Without Resistor)
	2 W (With 2 Resistors, 1/4 Watt, 120 Ω 5%)	3 W (With 4 Resistors, 1/4 Watt, 120 Ω 5%)
Mechanical		
Dimensions (W x L x H)	30 mm x 102 mm x 115 mm	
Environment		
Operating Temperature	-25 °C ~ +75 °C	
Storage Temperature	-40 °C ~ +85 °C	
Humidity	5 ~ 95% RH, non-condensing	

Software

Software
Supports interrupt driven software library
Supports VxCOM library

Wiring

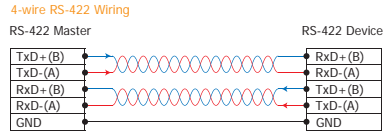
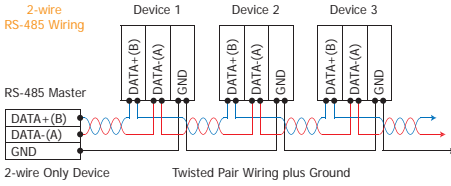

Pin Assignments

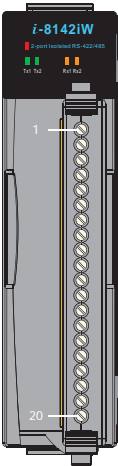

Terminal No.	Pin Assignment
01	D1+/TxD1+
02	D1-/TxD1-
03	RxD1+
04	RxD1-
05	GND1
06	D2+/TxD2+
07	D2-/TxD2-
08	RxD2+
09	RxD2-
10	GND2
11	N.C.
12	N.C.
13	N.C.
14	N.C.
15	N.C.
16	N.C.
17	N.C.
18	N.C.
19	N.C.
20	N.C.

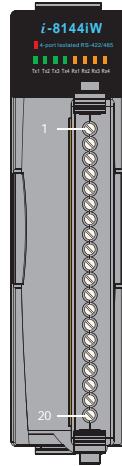

Terminal No.	Pin Assignment
01	D1+/TxD1+
02	D1-/TxD1-
03	RxD1+
04	RxD1-
05	GND1
06	D2+/TxD2+
07	D2-/TxD2-
08	RxD2+
09	RxD2-
10	GND2
11	D3+/TxD3+
12	D3-/TxD3-
13	RxD3+
14	RxD3-
15	GND3
16	D4+/TxD4+
17	D4-/TxD4-
18	RxD4+
19	RxD4-
20	GND4

Dimensions (Unit: mm)

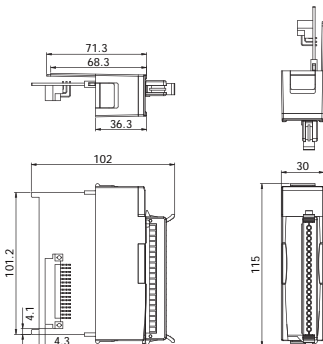

Ordering Information

I-8142IW-G CR	2-port Isolated RS-422/485 Module (RoHS)
I-8144IW-G CR	4-port Isolated RS-422/485 Module (RoHS)